

ELECTRIFIED DOOR HARDWARE

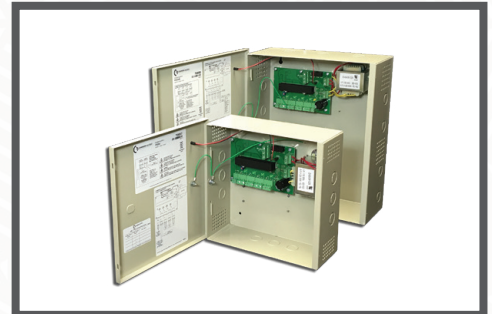
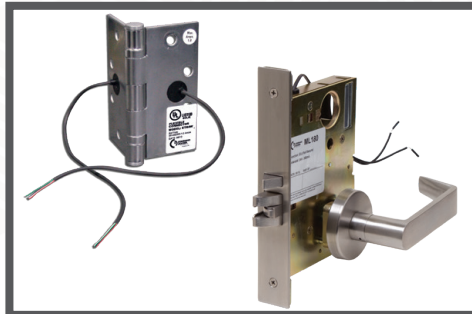
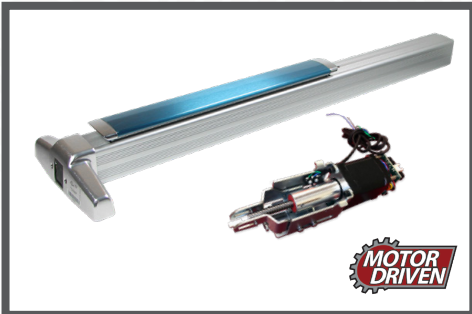

CATALOG PRICE LIST

TABLE OF CONTENTS

ABOUT US	2	POWER ACCESSORIES	38
ELECTRIFIED MORTISE LOCKS	4	POWER SUPPLIES	42
ELECTRIFIED CYLINDRICAL LOCKS	14	POWER TRANSFER HINGES	44
ELECTRIFIED EXIT TRIM	20	POWER TRANSFER PIVOTS	52
EXIT DEVICES & KITS	28	DOOR LOOPS	53



ABOUT COMMAND ACCESS

INNOVATIVE SOLUTIONS

INNOVATIVE SOLUTIONS

We are committed to finding better, more cost effective ways to furnish the electrified opening. Our commitment to our in-house engineering department supports our goal to provide our customers with the right solution at the right price and the right time. We appreciate all ideas and suggestions from our customer base.

C.A.T COMMITMENT

CAT COMMITMENT

- We answer the phone with a live voice Monday-Friday 7:30-4:30 PST.
- We strive to ship everything within our product offering within 3-10 days.
- We strive to enter and acknowledge your order within 24 hours.
- We have competent, reachable in-house technical support everyday during business hours.
- We have a customer service department that strives to deliver customer satisfaction.
- We maintain a large inventory of "ready to be modified" Command Access brand, Allegion, Assa Abloy, Best and other manufacturer's products.



BUILT IN USA

BUILT IN USA

Our commitment to American made products started from our humble beginnings with one milling machine and drill press. Moving forward our American owned/operated factory has continued investing in sophisticated US made multi-axis machine centers, allowing us to produce cost effective products right here in the USA.

NO HASSLE 3 YEAR WARRANTY

LIMITED WARRANTY: Command Access Technologies warrants that its products are free from defects in workmanship and material under normal use and service. Since CAT does not control product usage, CAT makes no representation as to the degree of security conveyed by the use of any product. This warranty does not cover defects or damage which occur from improper maintenance, improper storage, improper installation, shipping and handling, ordinary wear and tear, misuse, abuse, accidents, unauthorized service, work done by others or consequential damages. CAT will not pay for the cost of repair performed other than in accordance with this warranty. CAT can only perform authorized warranty work at the factory. CAT's only liability, in tort or contract, whether under this warranty or otherwise, is limited to providing repair or replacement of any product or component part which is proven to be defective as covered by the warranty, within three (3) years after delivery from CAT to the original purchaser. Written notice of a product or component part believed to be defective, as covered by this warranty, should be sent to Command Access Technologies 22901 La Palma Avenue, Yorba Linda, CA 92887. Include Claimant's name, address, phone, and identification of the product, invoice number and date, and a brief description of the defect. Upon receipt of such notice, a CAT representative will contact claimants to where to ship such product or component part, with shipping charges prepaid, for examination and, in the event such examination reveals a defect covered by this warranty, the product will be repaired (existing product installed 6+ months) or replaced (all new installations of 6 months or less). This warranty is in lieu of all other express warranties. To the extent permitted by law, all implied warranties are limited to the duration of this warranty. CAT shall not be liable for any incident or consequential damages. Some states do not allow limitations on how long an implied warranty lasts or the exclusion or limitation of incidental or consequential damages, so the above may not apply to you. This warranty gives you specific legal rights, and you may have other rights, which vary, from state to state.

SALES TEAM ROSTER

ALWAYS HERE TO HELP



DAYENA CHERRY
CSR TEAM MEMBER
DC@COMMANDACCESS.COM



SARAH KRISTOFF
CSR TEAM LEAD
SK@COMMANDACCESS.COM



JORDAN HENDERSON
CSR TEAM MEMBER
JH@COMMANDACCESS.COM



DANNY LOPEZ
CSR TEAM MEMBER
DL@COMMANDACCESS.COM



DJ VESSELS
TECH SUPPORT LEAD
DV@COMMANDACCESS.COM



FRED COLLIER
LEAD TRAINER
FC@COMMANDACCESS.COM



MARK FERRARO
SALES & MARKETING
MF@COMMANDACCESS.COM



MATEO KRISTOFF
DIRECTOR OF SALES & MARKETING
MK@COMMANDACCESS.COM



QR codes will appear throughout the catalog
you can scan with your smartphone. The take
you to helpful webpages, videos, & more!



ELECTRIFIED MORTISE LOCKS

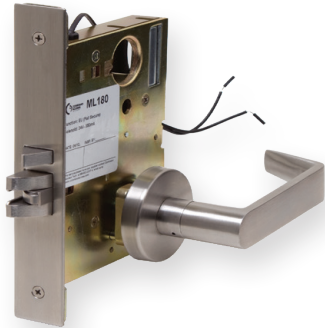

- EASY INSTALLATIONS - RELIABLE PERFORMANCE
- GRADE 1, ANSI RATED, 3 YEAR WARRANTY ON ALL ELECTRICAL & MECHANICAL PARTS
- UL, CSA, CSFM LISTED
- QUICK TO SHIP & A FAIR PRICE
- BUILT IN THE USA - DURABLE & DEPENDABLE

- Allows for remote keyless access & egress control
- Multiple functions and voltages to meet your requirements
- Common applications include stairwell doors, lobby entrances, computer rooms, classrooms, interior & exterior doors in schools, hospitals, offices and public buildings
- Mortise locks can be ordered complete, chassis only, or modification only.



SPECIFICATIONS

- All 12 or 24 volt solenoids rated for continuous duty; whether you're powering for 5 seconds or 8 hrs.
- Supplied w/ plug-in rectifier so there is no worry whether you're using AC or DC voltage.
- Low Current draw . . . multiple locks running off one power supply. 700mA @ 12V or 350mA @ 24V
- 3 year "no hassle" warranty issues reliability to the owner
- Available in EL (Fail Safe) or EU (Fail Secure)
- Multiple monitoring switch configurations available: Request to exit, Latchbolt Monitor, Door Position, etc.

FUNCTIONS

Storeroom – Latchbolt retracted by key outside or lever inside. **Fail Secure** - Applied power allows outside lever to retract latchbolt (EU) or **Fail Safe** - prevents latchbolt from retracting (EL). Inside lever is always free for immediate egress.

Classroom – Latchbolt retracted by key outside or lever inside. **Fail Secure** -Applied power allows outside lever to retract latchbolt (EU) or **Fail Safe** - prevents latchbolt from retracting (EL). . Outside lever can be maintained unlocked by key. Inside lever is always free for immediate egress.

Institutional – Latchbolt retracted by key on either side. **Fail Secure** - Applied power allows outside lever to retract latchbolt (EU) or **Fail Safe** - prevents latchbolt from retracting (EL).

Entry w/deadbolt – Latchbolt and deadbolt retracted by key outside or lever inside. **Fail Secure** - Applied power allows outside lever to retract latchbolt and deadbolt (EU) or **Fail Safe** -prevents latchbolt and deadbolt from retracting (EL). Inside lever is always free for immediate egress.

Privacy w/deadbolt - Latchbolt and deadbolt retracted by key outside or lever inside. **Fail Secure** - Applied power allows outside lever to retract latchbolt (EU) , unless deadbolt is thrown. Inside lever is always free for immediate egress. Available in EU (electronically unlocked) function only.

HOW TO ORDER

ALWAYS HERE TO HELP

FOR MODIFICATION, CHASSIS ONLY AND COMPLETE LOCKS

PREFIX or SUFFIX
 MD - Modification - Prefix
 CH - Chassis Only - Suffix

MODEL + FUNCTION
 Select a model number and add
 EL (Fail Safe) - Electronically Locked
 EU (Fail Secure) - Electronically Unlocked

VOLTAGE
 12 or 24 Volts must be specified
 Universal Input 10-30V see ML1 Motorized

OPTIONAL SWITCHES
 REX - Request-to-Exit DBM - Deadbolt Monitor
 DPS - Door Position Switch
 LBM - Latchbolt Monitor

M-OPTION FOR MORTISE LOCK
 For Command Access & Schlage model #s only.







- Intelligent auto voltage sensing 11-30 VDC
- Extremely low holding current = motorized
- Field selectable EU/EL with press of a button



FOR AND COMPLETE LOCKS ONLY

TRIM

 - Tubular  - Straight
 - Bent  - Curved  - Escutcheon

FINISH (BHMA std)

613 - Oil Rubbed Bronze 626 - Satin Chrome
 625 - Polished Chrome

SPECIAL ORDER

605 - Polished Bronze 612 - Satin Bronze
 606 - Satin Brass 630 - Satin Stainless

KEYWAY

S - "C" Kwy Standard SFIC - Small Format I/C Prep
 LC - Less Cylinder LFIC - Factory Large Format I/C Prep

ACCESSORIES

Faceplates - Storeroom function in specified finishes
 Strikes - 4-7/8" ASA Strike in specified finishes
 CRU2 - Current Reduction Unit (AC & DC input)
 4 Lead - 4' Wire Lead to switches
 10 Lead - 10' Wire lead to switches
 QC - Molex Connectors
 BR1 - Bridge Rectifier w/ 12" lead (included)
 BR5 - Bridge Rectifier w/ 5' lead

EXAMPLES

MODIFICATION ONLY

	PREFIX	MODEL	FUNCTION	SUFFIX	VOLTAGE	FINISH	KEYWAY	OPTIONS	ACC	COMPLETE PART #
Part #	MD	ML80	EL	-	12	-	-	REX	CRU2	MDML80 EL 12V REX CRU2
List \$	-	\$135	-	-	-	-	-	\$63	\$36	\$234

CHASSIS ONLY

	PREFIX	MODEL	FUNCTION	SUFFIX	VOLTAGE	FINISH	KEYWAY	OPTIONS	ACC	COMPLETE PART #
Part #	-	ML19092	EU	CH	-	-	-	REX LBM	-	ML19092 EU CH REX LBM
List \$	-	\$328	-	-	-	-	-	\$126		\$454

COMPLETE LOCK

	PREFIX	MODEL	FUNCTION	SUFFIX	VOLTAGE	FINISH	KEYWAY	OPTIONS	ACC	COMPLETE PART #
Part #	MD	ML1485	EU	L3B	12	626	S	REX	QC	ML1485 EU L3B 24V 626 S REX QC
List \$	-	\$567	-	+\$18	-	-	-	\$63	\$42	\$690

QUICK REFERENCE

ML LOCK	PAGE	ML LOCK	PAGE	ML LOCK	PAGE
COMMAND ML1	6	ACCURATE-BEST 35	11	ACCESSORIES	13
COMMAND MRC1	6	BEST 45 -CORBIN	11		
COMMAND LPM1	7	FALCON -YALE	12		



ELECTRIFIED MORTISE LOCKS

COMMAND ACCESS ML1 SERIES



- COMPATIBLE WITH SCHLAGE L9000 SERIES - DIRECT CHASSIS REPLACEMENT
- FEATURES & PERFORMANCE FOUND IN DOMESTICALLY MADE ANSI GRADE 1 MORTISE LOCKS AT A SIGNIFICANTLY LOWER COST
- FIELD INSTALLABLE REX KIT AVAILABLE
- ADDITIONAL OPTIONS INSTALLED AT FACTORY: REX, DPS, LBM, REXBPS (PG 12)
- FIELD REVERSIBLE HANDING WITHOUT OPENING LOCK CASE
- HIGHEST QUALITY MANUFACTURING BUILT TO LAST IN YORBA LINDA, CA
- MOTORIZED OPTION AVAILABLE 11-30V, FIELD SELECTABLE EU/EL

MODELS		TRIM	LEVERS	FINISHES	DIMENSIONS
• ML170	Classroom	L	3	605*	Diameter
• ML180	Storeroom	L	3	612*	L = 2-7/16"
• ML182	Institutional	L_B	6	613	LB= 2-3/4"
• ML1480	Entrance w/ Deadbolt	L_B	6	625	ESC= 1-3/4" x 8"
• ML1482	Institutional w/ Deadbolt	ESC	7	626	
• ML1485	Privacy w/ Deadbolt	ESC	7	630*	
• ML19092	<i>Motorized</i> Storeroom		17		
• ML19095	<i>Motorized</i> Institutional		17		

*Special Order
Complete Example: ML180 EU 24V ESC6 626

* B Rose available upcharge list \$18 **Upcharge \$55 for Escutcheon - Please call to confirm stock

SOLENOID LOCKS

COMMAND ACCESS COMPLETE LOCK RETROFIT SCHLAGE L9000

Specify Voltage. Field Hand-able. Fail Secure/Fail Safe. LFIC = Schlage compatible housing

√ or \$ = Available
- = Not Available

PART #	COMPLETE LOCK LIST \$	CHASSIS ONLY LIST \$	IN-STOCK TRIM				IN-STOCK FINISHES			KEYWAY		OPTIONAL SWITCHES						
			L3	L6	L7	L17	626	625	613	L	SC	SFIC	LFIC	REX	LBM	DPS	DBM	
ML170EU/EL	\$502	\$305	L3	L6	L7	L17	+55	✓	✓	✓	-	✓	+\$66	+\$28	+\$63	+\$63	-	-
ML180EU/EL	\$480	\$283	L3	L6	L7	L17	+55	✓	✓	✓	-	✓	+\$66	+\$28	+\$63	+\$63	+\$63	-
ML182EU/EL	\$520	\$304	L3	L6	L7	L17	-	✓	✓	✓	-	✓	+\$132	+\$56	+\$63	+\$63	+\$63	-
ML1480EU/EL	\$519	\$322	L3	L6	L7	L17	-	✓	✓	✓	-	✓	+\$66	+\$28	+\$63	+\$63	-	+\$63
ML1482EU/EL	\$559	\$343	L3	L6	L7	L17	-	✓	✓	✓	-	✓	+\$132	+\$56	+\$63	+\$63	-	+\$63
ML1485EU/EL	\$567	\$370	L3	L6	L7	L17	-	✓	✓	✓	-	✓	+\$66	+\$28	+\$63	+\$63	-	+\$63

* B Rose available upcharge list \$18 **Upcharge \$55 for Escutcheon - Please call to confirm stock

MOTORIZED LOCKS

COMMAND ACCESS COMPLETE LOCK RETROFIT SCHLAGE L9000

11-30V, Field Selectable Fail Secure/Fail Safe. Field Hand-able. LFIC = Schlage compatible housing



PART #	COMP LIST \$	CH LIST \$	IN-STOCK TRIM				IN-STOCK FINISHES			KEYWAY		OPTIONAL SWITCHES						
			L3	L6	L7	L17	626	625	613	L	SC	SFIC	LFIC	REX	LBM	DPS	DBM	
ML19092	\$525	\$328	L3	L6	L7	L17	+55	✓	✓	✓	-	✓	+\$66	+\$28	+\$63	+\$63	-	-
ML19095	\$564	\$348	L3	L6	L7	L17	+55	✓	✓	✓	-	✓	+\$132	+\$56	+\$63	+\$63	-	-

Command Access is not a licensee or affiliated, associated or connected with Allegion, Assa Abloy, Dorma, Stanley Security, Adams Rite, Arrow, Corbin Russwin, Mckinney, Pemko, Rixson, Sargent, Yale, Dor-O-matic, Falcon, Ives, Monarch, Schlage, Von Duprin, Best, Precision, Accurate, AHT, Baldwin, Bommer, Cal Royal, CR Laurence, Design Hardware, Emtek, First Choice, FSB, General Lock, Hager, Jackson, Keedex, Lawrence, LSDA, Marks, Marshal-Best, Molex, Omnia, PBB, PDQ, or any of their subsidiaries or affiliates.



MECHANICAL LOCKS COMMAND ACCESS COMPLETE LOCK RETROFIT SCHLAGE L9000

ALWAYS HERE TO HELP

✓ or \$ = Available
- = Not Available

Field Hand-able. LFIC = Schlage compatible housing

PART #	COMP LIST \$	CH LIST \$						626	625	613	L	SC	SFIC	LFIC	REX	LBM	DPS	DBM
ML1010	\$341	\$159	L3	L6	L7	L17	+55	✓	✓	✓	-	✓	+\$66	+\$28	+\$63	+\$63	+\$63	-
ML1040	\$362	\$165	L3	L6	L7	L17	+55	✓	✓	✓	-	✓	+\$66	+\$28	+\$63	+\$63	-	-
ML1053	\$379	\$182	L3	L6	L7	L17	-	✓	✓	✓	-	✓	+\$66	+\$28	+\$63	+\$63	-	+\$63
ML1050/70	\$368	\$171	L3	L6	L7	L17	+55	✓	✓	✓	-	✓	+\$66	+\$28	+\$63	+\$63	+\$63	-
ML1080	\$368	\$171	L3	L6	L7	L17	+55	✓	✓	✓	-	✓	+\$66	+\$28	+\$63	+\$63	+\$63	-
ML1082	\$409	\$193	L3	L6	L7	L17	-	✓	✓	✓	-	✓	+\$132	+\$56	+\$63	+\$63	+\$63	-

* B Rose available upcharge list \$18 **Upcharge \$55 for Escutcheon - Please call to confirm stock



COMMAND ACCESS MRC1 RETROFIT CHASSIS

- Our mortise retrofit chassis only series includes faceplate & strikeplate 626 standard
- ANSI Grade 1 mortise lock, UL Listed
- Significantly lower cost
- Additional options installed at factory: REX, DPS, & LBM (pg 12)
- Field reversible handing without opening lock case
- Works with the original manufacturers' trim (**some exceptions- Corbin Museo® Collection*)

MODELS	FUNCTIONS	FINISHES
• MRC135D	Best 35/45 Storeroom	613
• MRC135W	Best 35/45 Institutional	625
• MRC18080	Cal Royal 8000 Storeroom	626
• MRC180802	Cal Royal 8000 Institutional	
• MRC105/03	Corbin Russwin 2000 Storeroom	
• MRC104/01	Corbin Russwin 2000 Institutional	
• MRC181/51	Falcon MA Storeroom	
• MRC121/11	Falcon MA Institutional	
• MRC1681/1651	Falcon MA Entrance w/ Deadbolt	<i>Complete Example: MRC135W 626</i>

COMMAND ACCESS MRC1 SERIES

RETROFIT CHASSIS ONLY

Specify Voltage and Handing. Includes 626 faceplate & strike (other finishes available upon request at an upcharge \$50).

	PART #	LIST \$	626	L	SC	SFIC	LFIC	REX	LBM	DPS	DBM
BEST 35 SERIES	MRC135D EU/EL	\$396	✓	✓	-	✓	-	+\$63	+\$63	+\$63	-
	MRC135W EU/EL	\$419	✓	✓	-	✓	-	+\$63	+\$63	+\$63	-
CAL ROYAL 8800 SERIES	MRC18080 EU/EL	\$396	✓	✓	+34	+\$66	✓	+\$63	+\$63	+\$63	-
	MRC18082 EU/EL	\$419	✓	✓	+34	+\$66	✓	+\$63	+\$63	+\$63	-
CORBIN RUSSWIN 2000 SERIES	MRC105/03 EU/EL	\$396	✓	✓	+34	+\$66	✓	+\$63	+\$63	+\$63	-
	MRC104/01 EU/EL	\$419	✓	✓	+34	+\$66	✓	+\$63	+\$63	+\$63	-
FALCON MA SERIES	MRC181/51 EU/EL	\$396	✓	✓	+34	+\$66	✓	+\$63	+\$63	+\$63	-
	MRC121/11 EU/EL	\$419	✓	✓	+34	+\$66	✓	+\$63	+\$63	+\$63	-
	MRC1681/51 EU/EL	\$419	✓	✓	+34	+\$66	✓	+\$63	+\$63	-	+\$63

✓ or \$ = Available
- = Not Available



ELECTRIFIED LATCH PULLBACK



COMMAND ACCESS LPM180 SERIES



- LPM1 SERIES IS ELECTRIC LATCH PULLBACK IN A STANDARD MORTISE LOCK; COMPLETELY RETRACTED FOR A PUSH-PULL CONDITION OR IN CONJUNCTION WITH LOW ENERGY OPERATOR
- MORTISE LOCK VERSION AND APPLICATION SIMILAR TO PANIC ELR
- PM300 MODULE ALLOWS FOR UP TO 350' LONG WIRE RUNS & CONTINUOUS DUTY
- ALSO AVAILABLE WITH LEVER CONTROL - EU OR EL

SPECIFICATIONS

- No special lock prep required – fits standard mortise pocket.
- Retrofits Schlage “L” series lock
- All solenoids rated for continuous duty . . . whether you’re powering for 5 seconds or 8 hrs.
- Latch Retraction supplied w/ PM300, operating voltage 24VDC: Surge current- 2A, holding current-260mA
- Lever control- 700mA @ 12V or 350mA @ 24V
- 3 year “no hassle” warranty issues reliability to the owner
- Available in EU (Fail Secure) only; lever control available in EL (Fail Safe) or EU (Fail Secure)
- UL Listed

TRIM	LEVERS	DIMENSIONS
L	3	Diameter L = 2-7/16” LB= 2-3/4” ESC= 1-3/4” x 8” *Special Order Complete Example: ML180 L7B 626
L_B	6	
ESC	7	
	17	



✓ or \$ = Available
 - = Not Available

COMMAND ACCESS LPM1 SERIES

PART #	COMPLETE LOCK LIST \$	CHASSIS ONLY LIST \$	IN-STOCK TRIM					IN-STOCK FINISHES			KEYWAY	OPTIONAL SWITCHES					
			L	L_B	ESC	626	625	613	L	SC		SFIC	LFIC	REX	LBM	DPS	
LPM110	\$813	\$631	L3	L6	L7	L17	ESC	✓	✓	✓	-	✓	+\$66	+\$28	+\$63	+\$63	+\$63
LPM180	\$828	\$631	L3	L6	L7	L17	ESC	✓	✓	✓	-	✓	+\$66	+\$28	+\$63	+\$63	+\$63
LPM182	\$849	\$652	L3	L6	L7	L17	-	✓	✓	✓	-	✓	+\$66	+\$28	+\$63	+\$63	+\$63
LPM183	\$1003	\$787	L3	L6	L7	L17	ESC	✓	✓	✓	-	✓	+\$66	+\$28	+\$63	+\$63	+\$63
LPM184	\$1003	\$787	L3	L6	L7	L17	ESC	✓	✓	✓	-	✓	+\$66	+\$28	+\$63	+\$63	+\$63
LPM185	\$1003	\$787	L3	L6	L7	L17	-	✓	✓	✓	-	✓	+\$132	+\$56	+\$63	+\$63	+\$63
LPM186	\$1003	\$787	L3	L6	L7	L17	-	✓	✓	✓	-	✓	+\$66	+\$28	+\$63	+\$63	+\$63
LPM187	\$1003	\$787	L3	L6	L7	L17	-	✓	✓	✓	-	✓	+\$66	+\$28	+\$63	+\$63	+\$63
LPM188	\$1003	\$787	L3	L6	L7	L17	-	✓	✓	✓	-	✓	+\$66	+\$56	+\$63	+\$63	+\$63

* B Rose available upcharge list \$18 **Upcharge \$55 for Escutcheon - Please call to confirm stock

<p>LPM110EU <i>passage</i></p>	<p>Latchbolt Control: Lever Control:</p>	<p>Latchbolt retracted by lever outside or by lever inside. Applied power electronically (EU) retracts latchbolt for push/pull operation.</p> <p><u>Outside Lever & Inside Lever</u> Always free ingress & egress</p>
<p>LPM180EU <i>storeroom</i></p>	<p>Latchbolt Control: Lever Control:</p>	<p>Latchbolt retracted by key outside or by lever inside. Applied power electronically (EU) retracts latchbolt for push/pull operation.</p> <p><u>Outside Lever</u> Always Rigid (Locked) <u>Inside Lever</u> Always free egress</p>
<p>LPM182EU <i>institutional</i></p>	<p>Latchbolt Control: Lever Control:</p>	<p>Latchbolt retracted by key outside or inside (Double Cylinder operation). Applied power electronically (EU) retracts latchbolt for push/pull operation.</p> <p><u>Outside Lever & Inside Lever</u> Always Rigid (Locked)</p>
<p>LPM183EUxEL LPM184EUxEU <i>storeroom</i> X <i>storeroom</i></p>	<p>Latchbolt Control: X Lever Control:</p>	<p>Latchbolt retracted by key outside or inside Applied power electronically (EU) retracts latchbolt for push/pull operation.</p> <p><u>Outside Lever</u> EL - locked electronically: Applied power prohibits Outside lever from retracting latchbolt. EU - unlocked electronically: Applied power allows Outside lever to retract latchbolt. <u>Inside Lever</u> Always free egress. Latchbolt retracted by key outside or inside. Applied power electronically (EU only) retracts latchbolt for push/pull operation.</p>
<p>LPM185EUxEL LPM186EUxEU <i>institutional</i> X <i>storeroom</i></p>	<p>Latchbolt Control: X Lever Control:</p>	<p><u>Outside Lever</u> Always Clutching (Does not activate outside lever at anytime) <u>Inside Lever</u> EL - locked electronically: Applied power prohibits Inside lever from retracting latchbolt. EU - unlocked electronically: Applied power allows Inside lever to retract latchbolt.</p>
<p>LPM187EUxEL LPM188EUxEU <i>institutional</i> X <i>institutional</i></p>	<p>Latchbolt Control: X Lever Control:</p>	<p>Latchbolt retracted by key outside or inside (Double Cylinder operation). Applied power electronically (EU only) retracts latchbolt for push/pull operation.</p> <p><u>Outside Lever & Inside Lever</u> EL - locked electronically: Applied power prohibits both levers from retracting latchbolt. EU - unlocked electronically: Applied power allows both levers to retract latchbolt.</p>

CONTROLLED ACCESS APPLICATION

The Command Access LPM180 mortise lock may be utilized in conjunction with any access control application using standard mortise locksets. When activated the LPM180 creates a push/pull that satisfies both in-swinging and out-swinging doors. Inside free egress can be attained by turning the inside lever to manually open the door. Outside access is controlled by the access control system or by physical key override.

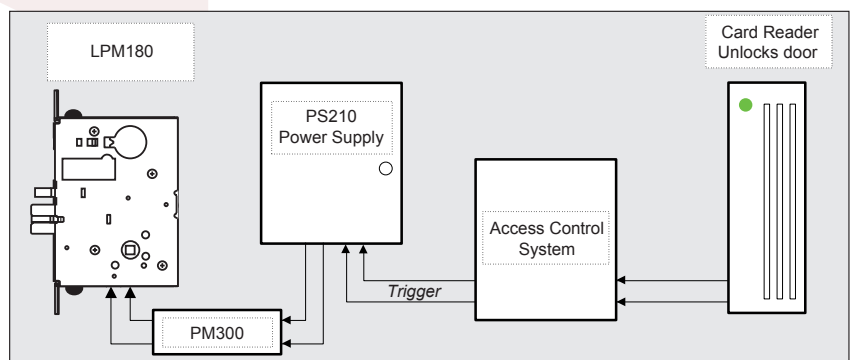



ELECTRIFIED LATCH PULLBACK



COMMAND ACCESS UNIVERSAL BATHROOM PRIVACY KIT

- UTILIZES THE ONLY LATCH PULLBACK X LEVER CONTROL IN A ML LOCK
- INCLUDES ACCESS CONTROLS NEEDED TO ADD PRIVACY FUNCTION TO SINGLE OCCUPANCY RESTROOM, MAINTAINS ADA ACCESSIBILITY
- INCLUDES WIRE DIAGRAM
- 2 PACKAGES: 1 INCLUDES EVERYTHING + ADD TO YOUR OPERATOR OF CHOICE. 2 INCLUDES EVERYTHING INCLUDING HIGH QUALITY LOW ENERGY OPERATOR.

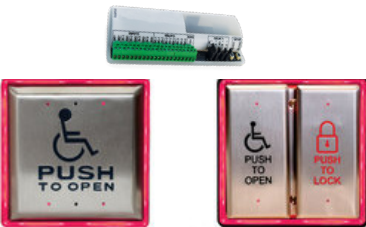

KIT	TRIM	LEVERS	DIMENSIONS
• UBPK1-FM-EUxEL	L	3	Diameter L = 2-7/16" LB = 2-3/4" ESC = 1-3/4" x 8" Complete Example: UBPK1-FM-EUxEL L6B 626
• UBPK1-FM-EUxEU	L	6	
• UBPK1-SM-EUxEL	L_B	6	
• UBPK1-SM-EUxEU	L_B	6	
• UBPK2-FM-EUxEL	ESC	7	
• UBPK2-FM-EUxEU	ESC	7	
• UBPK2-SM-EUxEL	ESC	17	
• UBPK2-SM-EUxEU	ESC	17	

UBPK1-FM-EUxEL	Includes: PS220B, LPM183 w/ DPS switch Complete Lock (latch retraction EU x lever control EL), Logic Module, Illuminated Outside/Inside (Push to Open & Push to Lock) Flush mounted push buttons.	\$2380
UBPK1-FM-EUxEU	Includes: PS220B, LPM184 w/ DPS switch Complete Lock (latch retraction EU x lever control EU), Logic Module, Illuminated Outside/Inside (Push to Open & Push to Lock) Flush mounted push buttons, DPS switch.	\$2380
UBPK1-SM-EUxEL	Includes: PS220B, LPM183 w/ DPS switch Complete Lock (latch retraction EU x lever control EL), Logic Module, Illuminated Outside/Inside (Push to Open & Push to Lock) Surface mounted push buttons, DPS switch.	\$2380
UBPK1-SM-EUxEU	Includes: PS220B, LPM184 w/ DPS switch Complete Lock (latch retraction EU x lever control EU), Logic Module, Illuminated Outside/Inside (Push to Open & Push to Lock) Surface mounted push buttons, DPS switch.	\$2380
UBPK2-FM-EUxEL	Includes: Low Energy Operator, PS220B, LPM183 w/ DPS switch Complete Lock (latch retraction EU x lever control EL), Logic Module, Illuminated Outside/Inside (Push to Open & Push to Lock) Flush mounted push buttons.	\$5380
UBPK2-FM-EUxEU	Includes: Low Energy Operator, PS220B, LPM184 w/ DPS switch Complete Lock (latch retraction EU x lever control EU), Logic Module, Illuminated Outside/Inside (Push to Open & Push to Lock) Flush mounted push buttons.	\$5380
UBPK2-SM-EUxEL	Includes: Low Energy Operator, PS220B, LPM183 w/ DPS switch Complete Lock (latch retraction EU x lever control EL), Logic Module, Illuminated Outside/Inside (Push to Open & Push to Lock) Surface mounted push buttons.	\$5380
UBPK2-SM-EUxEU	Includes: Low Energy Operator, PS220B, LPM184 w/ DPS switch Complete Lock (latch retraction EU x lever control EU), Logic Module, Illuminated Outside/Inside (Push to Open & Push to Lock) Surface mounted push buttons.	\$5380
EME KIT ADD	Add on Emergency Annunciator Kit for UBPK (Pictured Above)	\$550

ELECTRIFIED MORTISE LOCKS

ALWAYS HERE TO HELP

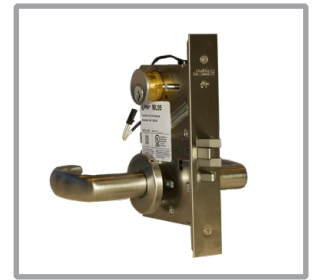
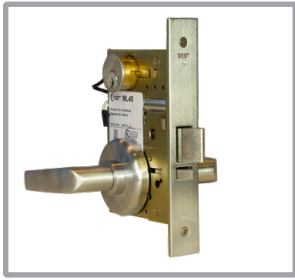

✓ or \$ = Available
- = Not Available

PART #	LIST \$			Stock Trim Styles					Stock Finishes			Keyway		Optional Switches			
	COMPLETE LOCK List \$	CHASSIS ONLY List \$	MODIFICATION ONLY List \$	3H	15H	14H	M*	626	625	613	L	SC	SFIC (less core)	LFIC (less core)	Request to Exit (REX)	Latchbolt Monitor (LBM)	Door Position (DPS)

ACCURATE

MODIFICATION ONLY (Customer's Accurate 9145/FSB 7145 Chassis)
Specify EU or EL, Voltage and Handing.

STOREROOM	ML59EU/EL	-	-	\$154	-	-	-	-	-	-	-	-	-	-	-	+\$63	+\$63	+\$63	-
-----------	-----------	---	---	-------	---	---	---	---	---	---	---	---	---	---	---	-------	-------	-------	---

ARROW

MODIFICATION ONLY (Customer's AM17 or BM17 Chassis) - Specify EU or EL, Voltage and Handing.

FUNCTION	PART #	COM \$	CH \$	MD \$	3H	15H	14H	M*	626	625	613	L	SC	SFIC	LFIC	REX	LBM	DPS	DBM
STOREROOM	ML77EU/EL	-	-	\$154	-	-	-	-	-	-	-	-	-	-	-	+\$63	-	-	-

BEST 45

MODIFICATION (Customer's Best 45HD, 45HAB & 45HUNAB Chassis) / CHASSIS ONLY / COMPLETE LOCK
Specify Voltage and Handing. Special order trims and finishes available. Faceplates & Strikes available in 626

FUNCTION	PART #	COM \$	CH \$	MD \$	3H	15H	14H	M*	626	625	613	L	SC	SFIC	LFIC	REX	LBM	DPS	DBM
STOREROOM	ML45DEU/EL	\$880	\$465	\$146	3H	15H	-	14H	✓	✓	✓	✓	-	✓	-	+\$63	+\$63	+\$63	-
INSTITUTIONAL	ML45WEU/EL	\$945	\$465	\$161	3H	15H	-	14H	✓	✓	✓	✓	-	✓	-	+\$63	+\$63	+\$63	-
ENTRANCE W/DB	ML453DEU/EL	CALL	\$497	\$161	3H	15H	-	14H	✓	✓	✓	✓	-	✓	-	-	-	-	-
PRIVACY W/ DB	ML453TEU	CALL	\$651	\$203	3H	15H	-	14H	✓	✓	✓	✓	-	✓	-	-	-	-	-

CAL ROYAL

MODIFICATION (Customer's Cal-Royal M8080 & M8453 Chassis) / COMPLETE LOCK
Specify Voltage and Handing.

FUNCTION	PART #	COM \$	CH \$	MD \$	TS	SS	GS	JS	626	625	613	L	SC	SFIC	LFIC	REX	LBM	DPS	DBM
STOREROOM	ML8080EU/EL	\$603	-	\$146	TS	SS	GS	JS	✓	✓	✓	-	✓	✓	✓	+\$63	+\$63	-	-
ENTRANCE W/DB	ML8053EU/EL	\$646	-	\$182	TS	SS	GS	JS	✓	✓	✓	-	✓	✓	✓	+\$63	+\$63	-	-

CORBIN RUSSWIN

MODIFICATION (Customer's Corbin ML2057 Chassis) / COMPLETE LOCK
Specify Voltage. Faceplates & Strikes available in 613, 625, 626 (see page 11 for pricing)

FUNCTION	PART #	COM \$	CH \$	MD \$	LWA	NSA	PSA	626	625	613	L	SC	SFIC	LFIC	REX	LBM	DPS	DBM
STOREROOM	ML05EU/03EL	\$1027	\$623	\$144	LWA	NSA	PSA	✓	CALL	CALL	✓	✓	✓	✓	+\$63	+\$63	+\$63	-
INSTITUTIONAL	ML04EU/01EL	\$1124	\$640	\$161	LWA	NSA	PSA	✓	CALL	CALL	✓	✓	✓	✓	+\$63	+\$63	+\$63	-



ELECTRIFIED MORTISE LOCKS



✓ or \$ = Available
- = Not Available

PART #	LIST \$			Stock Trim Styles					Stock Finishes			Keyway			Optional Switches			
	COMPLETE LOCK List \$	CHASSIS ONLY List \$	MODIFICATION ONLY List \$	□	□	□	□	□	626	625	613	S	LC	SFIC (less core)	LFIC (less core)	Request to Exit (REX)	Latchbolt Monitor (LBM)	Door Position (DPS)

FALCON

MODIFICATION (Customer's Corbin ML2057 Chassis) / COMPLETE LOCK
Specify Voltage. Faceplates & Strikes available in 613, 625, 626 (see page 11 for pricing)

FUNCTION	PART #	COMPLETE LOCK List \$	CHASSIS ONLY List \$	MODIFICATION ONLY List \$	□	□	□	□	□	626	625	613	S	LC	SFIC (less core)	LFIC (less core)	Request to Exit (REX)	Latchbolt Monitor (LBM)	Door Position (DPS)	Deadbolt Monitor
STOREROOM	ML81EU/51EL	-	-	\$144	-	-	-	-	-	-	-	-	-	-	-	-	+\$63	+\$63	-	-
INSTITUTIONAL	ML21EU/11EL	-	-	\$161	-	-	-	-	-	-	-	-	-	-	-	-	+\$63	+\$63	-	-
ENTRANCE W/DB	ML681EU/EL	-	-	\$161	-	-	-	-	-	-	-	-	-	-	-	-	+\$63	+\$63	-	-

1. Not available on deadbolt models
2. Call for availability of deadbolt trims.

SARGENT

MODIFICATION (Customer's Sargent 8237 Chassis) / CHASSIS ONLY / COMPLETE LOCK Specify Voltage. Faceplates & Strikes available in 613, 625, 626 (see page 11 for pricing). Fire link is removed for LBM.

FUNCTION	PART #	COMPLETE LOCK List \$	CHASSIS ONLY List \$	MODIFICATION ONLY List \$	LNJ	LNL	LNB	LNP	□	626	625	613	L	SC	SFIC	LFIC	REX	LBM	DPS	DBM	
STOREROOM	ML371EU/70EL	\$1016	\$577	\$144	LNJ	LNL	LNB	LNP	-	✓	-	✓	✓	✓	✓	✓	✓	+\$63	+\$63	-	-
INSTITUTIONAL	ML373EU/11EL	\$1051	\$601	\$161	LNJ	LNL	LNB	LNP	-	✓	-	✓	✓	✓	✓	✓	✓	+\$63	+\$63	-	-

SCHLAGE SOLENOID LOCKS

MODIFICATION (Customer's Schlage L9050/9070 & L9453 Chassis) / CHASSIS ONLY / COMPLETE LOCK Specify Voltage. Faceplates & Strikes available in 613, 625, & 626. Call Factory for other finishes

FUNCTION	PART #	COM \$	CH \$	MD \$	□	□	□	□	□	626	625	613	L	SC	SFIC	LFIC	REX	LBM	DPS	DBM	
CLASSROOM	ML70EU/EL	\$1072	\$491	\$144	03	06	07	17	L/N	✓	✓	✓	✓	✓	✓	✓	✓	+\$63	+\$63	-	-
STOREROOM	ML80EU/EL	\$1072	\$481	\$135	03	06	07	17	L/N	✓	✓	✓	✓	✓	✓	✓	✓	+\$63	+\$63	+\$63	+\$63
INSTITUTIONAL	ML82EU/EL	\$1137	\$502	\$154	03	06	07	17	L/N	✓	✓	✓	✓	✓	✓	✓	✓	+\$63	+\$63	+\$63	+\$63
ENTRANCE W/DB	ML480EU/EL	\$1107	\$526	\$169	03	06	07	17	L/N	✓	✓	✓	✓	✓	✓	✓	✓	+\$63	+\$63	-	+\$63
INSTITUTIONAL W/DB	ML482EU/EL	\$1197	\$562	\$186	03	06	07	17	L/N	✓	✓	✓	✓	✓	✓	✓	✓	+\$63	+\$63	-	+\$63
PRIVACY w/DB	ML485EU/EL	\$1154	\$573	\$212	03	06	07	17	L/N	✓	✓	✓	✓	✓	✓	✓	✓	+\$63	+\$63	-	+\$63



MOTORIZED LOCKS COMMAND ACCESS COMPLETE LOCK RETROFIT SCHLAGE L9000

11-30V, Field Selectable Fail Secure/Fail Safe. Field Hand-able. LFIC = Schlage compatible housing

FUNCTION	PART #	COM \$	CH \$	MD \$	□	□	□	□	□	626	625	613	L	SC	SFIC	LFIC	REX	LBM	DPS	DBM	
STOREROOM	ML92-M EU/EL	\$1107	\$526	\$190	03	06	07	17	L/N	✓	✓	✓	✓	✓	✓	✓	✓	+\$63	+\$63	-	-
INSTITUTIONAL	ML95-M EU/EL	\$1182	\$547	\$209	03	06	07	17	L/N	✓	✓	✓	✓	✓	✓	✓	✓	+\$63	+\$63	-	-

YALE

MODIFICATION (Customer's Yale 8808 Chassis) / CHASSIS ONLY
Specify Voltage and Handing. Faceplates (List \$40) & Strikes available in 626 (see page 11 for pricing).
Fire link is removed for LBM.

FUNCTION	PART #	COM \$	CH \$	MD \$	□	□	□	□	□	626	625	613	L	SC	SFIC	LFIC	REX	LBM	DPS	DBM
STOREROOM	ML91EU/90EL	\$1057	\$623	\$157	CRR	AUR	MOR	PBR	CALL	✓	-	-	✓	✓	✓	✓	+\$63	+\$63	-	-
INSTITUTIONAL	ML95EU/94EL	\$1120	\$640	\$174	CRR	AUR	MOR	PBR	CALL	✓	-	-	✓	✓	✓	✓	+\$63	+\$63	-	-

ACCESSORIES

 ALWAYS HERE TO HELP

MORTISE LOCK SWITCH OPTIONS

A variety of monitoring switches are available for Command Access modified mortise lockset. All switches are SPDT (single pole, double throw) and either mechanical or reed type. Since each manufacturer has different configurations and designs, switch options not available with all mortise locks. Please refer to the dedicated specification page for your desired mortise lock model, or consult the factory for switch application verification. With the exception of a few field installable REX kits, all other switches must be installed at the factory. Here is a list of available switches and their definition.

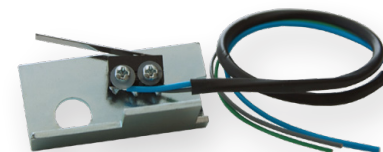

REX - Request to Exit or AE switch available - sends a signal to alert the control panel that the door is about to be opened by someone intending to exit from within the secured area.

LBM- Latchbolt Monitor switch available - sends a signal to the control panel to monitor the position of the latchbolt.

DPS - Door Position switch available - sends a signal to the control panel to monitor the position of the door.

DBM - Deadbolt Monitor switch available - sends a signal to the control panel to monitor the position of the deadbolt.

CATREXKIT-ML ¹	Command Access ML/Schlage L-series mortise lock field installable REX (Request to Exit) kit.	\$63
CATLBMKIT-ML ¹	Command Access ML/Schlage L-series mortise lock field installable LBM (Latchbolt Monitor) kit	\$63
CATREXLBMKIT-ML ¹	Command Access ML/Schlage L-series mortise lock field installable LBM (Latchbolt Monitor) + REX (Request to Exit) kit	\$120
SCHREXKIT-FE-ML ²	Schlage L-series mortise lock field installable REX (Request to Exit) kit.	\$74
REX	Request to Exit switch installed in Mortise Lock	\$63
LBM	Latch Bolt Monitor switch installed in Mortise Lock	\$63
DPS	Door Position switch installed in Mortise Lock	\$63
DBM	Deadbolt Monitor switch installed in Mortise Lock	\$63
RXBP	Request to Exit Switch with Bypass option to shunt the signal during unlocked cycles installed in mortise lock	\$111

1. Requires the lock body to be opened for installation.

2. Only compatible with new Schlage L909x Lock Body with Cutout for REX.

ACCESSORIES & REPLACEMENT FOR MORTISE LOCKS

FACEPLATE	Storeroom or Deadbolt function in specified finishes.	\$40
STRIKE	4-7/8" ASA Strike in specified finishes	\$40
CRU	Current Reduction Unit	\$34
4' LEAD	Add 4' lead to any switch (per switch)	\$17
BR1	Bridge Rectifier w/ 12" Lead	\$17
BR5	Bridge Rectifier w/ 5' Lead	\$28
QC	8-pin or 12-pin Molex Connectors added to locking device retrofit ElectroLynx or Allegion Connect	\$42
QC w/ lead	8-pin or 12-pin Molex Connectors w/3-5' lead added to locking device retrofit ElectroLynx or Allegion Connect	\$74
Door Cord QC	3-5' Door Cord to connect a QC prepped locking device to the power transfer hinge	\$85
SOL-ML	Mortise Lock Replacement Solenoids (Specify brand, EU or EL & Voltage	\$85

Allegion Connect® is a registered trademark of Allegion

ElectroLynx® is a registered trademark of Assa Abloy

 molex



Micro-Fit 3.0™ Interconnect System available to retrofit common quick connection systems such as ElectroLynx® or Allegion Connect®.

ELECTRIFIED CYLINDRICAL LOCK

- EASY INSTALLATIONS - RELIABLE PERFORMANCE
- GRADE 1, ANSI RATED
- UL, CSA, CSFM LISTED
- QUICK TO SHIP & A FAIR PRICE
- BUILT IN THE USA - DURABLE & DEPENDABLE
- 3 YEAR WARRANTY ON ALL ELECTRICAL & MECHANICAL PARTS

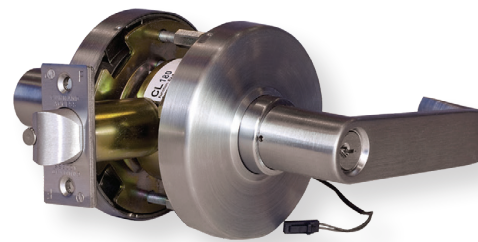

- Allows for remote keyless access & egress control
- Multiple functions and voltages to meet your requirements
- Common applications include computer rooms, classrooms, interior in schools, hospitals, offices and public buildings
- Cylindrical locks can be ordered complete or modification only (of customer's lock).

SPECIFICATIONS

- UL and CSFM Listings; non-handed 161 prep
- All 12 or 24 volt solenoids rated for continuous duty . . . whether you're powering for 5 seconds or 8 hours.
- Supplied w/ plug-in rectifier so there is no worry whether you're using AC or DC voltage.
- Low Current draw . . . multiple locks running off one power supply. 700mA @ 12V or 350mA @ 24V
- REX switch available on most models
- Available in EL (Fail Safe) or EU (Fail Secure)
- 3 year "no hassle" warranty issues reliability to the owner



FUNCTIONS

STOREROOM – Latchbolt retracted by key outside or lever inside. *Fail Secure* - Applied power allows outside lever to retract latchbolt (EU) or *Fail Safe* - prevents latchbolt from retracting (EL). Inside lever is always free for immediate egress.

CLASSROOM – Latchbolt retracted by key outside or lever inside. *Fail Secure* - Applied power allows outside lever to retract latchbolt (EU) or *Fail Safe* - prevents latchbolt from retracting (EL). Inside lever is always free for immediate egress. Outside lever can be maintained unlocked by key. Inside lever is always free for immediate egress.

STOREROOM CLUTCHING – Latchbolt retracted by key outside or lever inside. *Fail Secure* - Applied power allows outside lever to retract latchbolt (EU) or *Fail Safe* - prevents latchbolt from retracting (EL). Inside lever is always free for immediate egress. Outside lever is freewheeling (clutching) when locked. Inside lever is always free for immediate egress.

HOW TO ORDER

ALWAYS HERE TO HELP

FOR MODIFICATION AND COMPLETE LOCKS

PREFIX

MD - Modification

MODEL + FUNCTION

Select a model number and add
 EL (Fail Safe) - Electronically Locked
 EU (Fail Secure) - Electronically Unlocked

VOLTAGE



12 or 24 Volts must be specified



OPTIONAL SWITCHES

REX - Request-to-Exit

FOR COMPLETE LOCKS ONLY

TRIM

 - Tubular
 - Bent

 - Straight
 - Curved

FINISH (BHMA std)

605 - Polished Bronze 625 - Polished Chrome
 613 - Oil Rubbed Bronze 626 - Satin Chrome
SPECIAL ORDER
 606 - Satin Brass 612 - Satin Bronze

KEYWAY

SC - "C" Kwy Standard SFIC - Small Format I/C Prep
 LC - Less Cylinder LFIC - Factory Large Format I/C Prep

ACCESSORIES

Strikes - 4-7/8" ASA Strike in specified finishes
 CRU2 - Current Reduction Unit (AC & DC input)
 4 Lead - 4' Wire Lead to switches
 10 Lead - 10' Wire lead to switches
 QC - Molex Connectors
 BR1 - Bridge Rectifier w/ 12" lead (included)
 BR5 - Bridge Rectifier w/ 5' lead

EXAMPLES

MODIFICATION ONLY

	PREFIX	MODEL	FUNCTION	SUFFIX	VOLTAGE	FINISH	KEYWAY	OPTIONS	ACC	COMPLETE PART #
Part #	MD	CL93D	EL	-	12	-	-	REX	CRU2	MDCL93D EL 12V REX CRU2
List \$	-	\$135	-	-	-	-	-	\$63	\$36	\$234

COMPLETE LOCK

	PREFIX	MODEL	FUNCTION	SUFFIX	VOLTAGE	FINISH	KEYWAY	OPTIONS	ACC	COMPLETE PART #
Part #	-	CL180LE	EU	L17	-	626	SFIC	REX	-	CL180LE EU L17 626 SFIC REX
List \$	-	\$399	-	-	-	-	-	INCLUDED	-	\$399

QUICK REFERENCE

CL LOCK	PAGE	CL LOCK	PAGE
COMMAND CL1	17	ACCESSORIES	19
ARROW - CORBIN	18		
LSDA - SCHLAGE	18		

ELECTRIFIED CYLINDRICAL LOCK

COMMAND ACCESS CL1 SERIES



- FEATURES & PERFORMANCE FOUND IN DOMESTICALLY MADE ANSI GRADE 1 CYLINDRICAL LOCKS AT A SIGNIFICANTLY LOWER COST
- FIELD INSTALLABLE REX KIT AVAILABLE
- RETROFITS SCHLAGE ND 80 PREP
- STANDARD 161 PREP
- UL LISTED
- HIGHEST QUALITY MANUFACTURING BUILT TO LAST IN YORBA LINDA, CA

LOW ENERGY = MOTORIZED SPECS WITH PROVEN SOLENOID TECHNOLOGY UNIVERSAL INPUT TAKES 12-30V

MODELS

CL180 | Storeroom Clutching

CL180LE | Low Energy Storeroom Clutching

LEVERS



FINISHES

605 625
612 626
613

COMMAND ACCESS

COMPLETE LOCK

Specify Voltage. Typically Stocked Finishes - 605*, 612*, 613, 625, 626. Available with i-Option. 2-3/8" backset List \$35

FUNCTION	PART #	CH \$				626	625	613	L	SC	SFIC	LFIC	REX
STOREROOM	CL180EU/EL	\$324	-	L6	L7*	L17	✓	✓	✓	✓	✓	✓	+\$63
LE STOREROOM ¹	CL180-LE EU/EL	\$399	-	L6	L7*	L17	✓	✓	✓	✓	✓	✓	✓

✓ or \$ = Available
- = Not Available

1. Universal input 12-30V & REX included

* Limited availability, please call to confirm stock.

FUNCTION	PART #	CH \$				626	625	613	L	SC	SFIC	LFIC	REX
PASSAGE	CL1010	\$188	-	L6	-	L17	✓	-	✓	-	-	-	+\$63
PRIVACY	CL1040	\$192	-	L6	-	L17	✓	-	✓	✓	-	-	+\$63
ENTRY/OFFICE	CL1053	\$198	-	L6	-	L17	✓	-	✓	✓	-	-	+\$63
CLASSROOM	CL1070	\$198	-	L6	-	L17	✓	-	✓	✓	-	-	+\$63
STOREROOM	CL1080	\$198	-	L6	-	L17	✓	-	✓	✓	✓	✓	+\$63

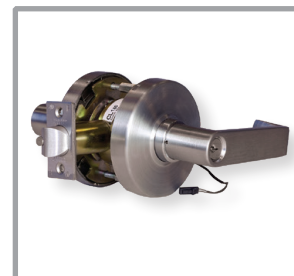
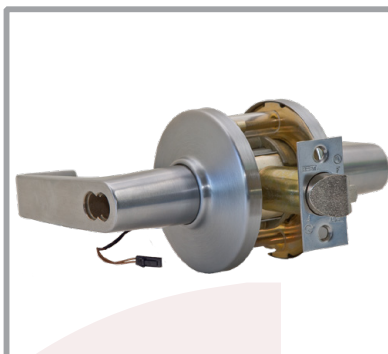

ELECTRIFIED CYLINDRICAL LOCK

Specify EU or EL, Voltage and Handing.

✓ or \$ = Available
- = Not Available

ARROW

MODIFICATION ONLY (Customer's Arrow QL82 for clutching lever)
Specify Voltage.

FUNCTION	PART #	COM \$	MD \$	626	625	613	L	SC	SFIC	LFIC	REX
STOREROOM CLUTCH	CL878 EU	-	\$186	-	-	-	-	-	-	-	-
STOREROOM CLUTCH	CL878 EL	-	\$186	-	-	-	-	-	-	-	-

BEST

MODIFICATION (Customer's Best 93K Series) / COMPLETE LOCK
Specify Voltage. Typically Stocked Finishes - 626. C & D Roses Available

FUNCTION	PART #	COM \$	MD \$	626	625	613	L	SC	SFIC	LFIC	REX			
STOREROOM	CL93D EU/EL	\$659	\$135	-	15	-	14	✓	-	-	✓	✓	✓	+\$63

CAL ROYAL

MODIFICATION (Customer's Cal Royal CGN05) / COMPLETE LOCK
Specify Voltage. Typically Stocked Finishes - 613, 625, 626.

FUNCTION	PART #	COM \$	MD \$	626	625	613	L	SC	SFIC	LFIC	REX		
STOREROOM CLUTCH	CLCR05 EU/EL	\$411	\$127	-	-	-	-	✓	✓	✓	✓	✓	+\$63

CORBIN RUSSWIN

MODIFICATION (Customer's Corbin CL3357) / COMPLETE LOCK
Specify Voltage. Typically Stocked Finishes - 613, 625, 626.

FUNCTION	PART #	COM \$	MD \$	626	625	613	L	SC	SFIC	LFIC	REX			
STOREROOM	CL05 EU	\$670	\$152	-	NZD	-	PZD	✓	-	-	✓	✓	✓	+\$63
STOREROOM	CL03 EL	\$670	\$152	-	NZD	-	PZD	✓	-	-	✓	✓	✓	+\$63

LSDA





MODIFICATION ONLY (Customer's LSDA C5400 Grade One Lock)
Specify Voltage.

FUNCTION	PART #	COM \$	MD \$	626	625	613	L	SC	SFIC	LFIC	REX	
STOREROOM CLUTCH	CLC5400 EU/EL	-	\$212	-	-	-	-	-	-	-	-	+\$63





ELECTRIFIED CYLINDRICAL LOCK

MARKS MODIFICATION ONLY (Customer's Marks 195F)
Specify Voltage.





✓ or \$ = Available
- = Not Available

FUNCTION	PART #	COM \$	MD \$					626	625	613	L	SC	SFIC	LFIC	REX
STOREROOM	CLF95 EU/EL	-	\$159	-	-	-	-	-	-	-	-	-	-	-	+\$63

SARGENT MODIFICATION (Customer's Sargent 10G04) / COMPLETE LOCK
Specify Voltage. Typically Stocked Finishes - 613, 625, 626. Call for availability.

FUNCTION	PART #	COM \$	MD \$					626	625	613	L	SC	SFIC	LFIC	REX
STOREROOM	CL371 EU	\$670	\$138	-	-	-	-	✓	-	-	✓	✓	✓	✓	+\$63
STOREROOM	CL370 EL	\$670	\$138	-	-	-	-	✓	-	-	✓	✓	✓	✓	+\$63

SCHLAGE MODIFICATION (Customer's Schlage ND12PD, ND70PD, ND80PD, ND94PD, ND96PD) / COMPLETE LOCK
Specify Voltage. Typically Stocked Finishes - 613, 625, 626. Classic 'C' type keyway comes standard.

FUNCTION	PART #	COM \$	MD \$					626	625	613	L	SC	SFIC	LFIC	REX
EXIT	CLN12 EU/EL	\$690	\$116	-	RHO	ATH*	SPA	✓	✓	+\$33	-	-	-	-	+\$63
CLASSROOM	CLN70 EU/EL	\$756	\$116	-	RHO	ATH*	SPA	✓	✓	+\$33	✓	✓	+\$56	✓	+\$63
STOREROOM	CLN80 EU/EL	\$756	\$116	-	RHO	ATH*	SPA	✓	✓	+\$33	✓	✓	+\$56	✓	+\$63
STOREROOM CLUTCH	CLN96 EU/EL	\$770	\$124	-	RHO	ATH*	SPA	✓	✓	+\$33	✓	✓	+\$56	✓	+\$63

Add \$35 list for Schlage original C & Everest C123.
Add \$15 list for Control key.
Add \$70 List net for RD & TD (No upcharge for JD).

*Athens Handle Style Only Available in PD - 626

NEED A LOCKING HARDWARE POWER SUPPLY? PG 42

RECOMMENDED LOCKING HARDWARE POWER SUPPLIES:

- PS202/202B
- PS204/PS204B
- PS210
- PS220/220B
- PS440B
- PS480B



ACCESSORIES

ALWAYS HERE TO HELP

Command Access current reduction unit is recommended for “fail safe” or “unlock cycle” applications to reduce heat and extend solenoid life meaning no more “hot levers”!

CRU2 - Adjusts incoming voltage to maximize the efficiency of our 12 or 24VDC locks.

VC2412 - Voltage Convert 24VDC to 12VDC. Voltage converter takes incoming 24VDC and outputs 12VDC to power any locking device, reader & more.



CYLINDRICAL LOCK SWITCH OPTIONS

All Command Access modified cylindrical lever locks are available with REX monitor switches. All switches are SPDT (single pull, double throw) and either mechanical or reed type. With the exception of a few field installable REX kits, all other REX switches must be installed at the factory. Here is a list of available switches and their definition.

REX - Request to Exit or AE switch available (depending on manufacturer) - sends a signal to alert the control panel that the door is about to be opened by someone intending to exit from within the secured area

REXKIT-CL - Field Installable REX (Request to Exit) switch kits are available for a few cylindrical locks. Each kit includes the switch assembly and all necessary items needed for quick field installation.

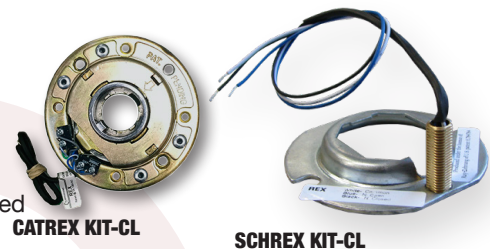

ACCESSORIES & REPLACEMENT FOR CYLINDRICAL LOCKS

CATREXKIT-CL	REX (Request to Exit) installed on CAT CL1 spring cage field installable) kit.	\$74
SCHREXKIT-CL	Schlage ND series Anti-Rotation Plate with Request to Exit (REX) switch installed	\$74
REX	Request to Exit (REX) switch installed installed on cylindrical lock	\$63

ACCESSORIES & REPLACEMENT FOR CLYLINDRICAL LOCKS

STRIKE	Standard ASA Strike in specified finishes	\$40
CRU	Current Reduction Unit	\$34
4' LEAD	Add 4' lead to any switch (per switch)	\$17
BR1	Bridge Rectifier w/ 12" Lead	\$17
BR5	Bridge Rectifier w/ 5' Lead	\$28
QC	8-pin or 12-pin Molex Connectors added to locking device retrofit ElectroLynx or Allegion Connect	\$42
QC w/ lead	8-pin or 12-pin Molex Connectors w/3-5' lead added to locking device retrofit ElectroLynx or Allegion Connect	\$74
Door Cord QC	3-5' Door Cord to connect a QC prepped locking device to the power transfer hinge	\$85
SOL-CL	Cylindrical Lock Replacement Solenoids (Specify brand, EU or EL & Voltage) Factory replacement only	\$85

Allegion Connect® is a registered trademark of Allegion

ElectroLynx® is a registered trademark of Assa Abloy

Micro-Fit 3.0™ Interconnect System available to retrofit common quick connection systems such as ElectroLynx® or Allegion Connect®.

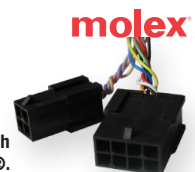



ELECTRIFIED EXIT TRIM



- ELECTRIC LOCKING OR UNLOCKING BY A REMOTE SWITCH
- INTERIOR OR EXTERIOR ENTRANCE (INGRESS) WITH MECHANICAL EXIT DEVICE
- WHERE FIRE/LIFE SAFETY CODES REQUIRE A “FAIL SAFE” CONDITION
- STAIRWAY CONDITIONS



SPECIFICATIONS

- Supplied w/ plug-in rectifier so there is no worry whether you’re using AC or DC voltage.
- Low Current draw . . . multiple locks running off one power supply.
- Amperage – 250mA @ 12V or 150mA @ 24V
- 700mA @ 12V or 350mA @ 24V (Precision Only)
- All 12 or 24 volt solenoids rated for continuous duty . . . whether you’re powering for 5 seconds or 8 hours.
- Use CRU2 for universal voltage input 12-30V
- REE switch available on most models
- Available in EL (Fail Safe) or EU (Fail Secure)
- 3 year “no hassle” warranty issues reliability to the owner
- Field installation kit not available for Command Access modification of exit trim

FUNCTIONS

STOREROOM (EU) - *Fail Secure* Latchbolt retracted by key outside or lever inside. Applied power allows outside lever to retract latchbolt. Inside lever is always free for immediate egress. Inside push pad is always free for immediate egress.

STOREROOM (EL) - *Fail Safe* Latchbolt retracted by key outside or lever inside. Applied power prevents latchbolt from retracting. Inside lever is always free for immediate egress. Inside push pad is always free for immediate egress.

EXIT TRIM SWITCH OPTIONS

* Most Command Access electrified/modified exit trims are available with an REE (Request to Enter) switch. This switch is a SPDT (single pull, double throw) switch that sends a signal to alert the control panel that the door is about to be opened by someone intending on entering a secured area. This switch must be installed at the factory.

HOW TO ORDER

FOR MODIFICATION AND COMPLETE TRIM

PREFIX
MD - Modification

MODEL + FUNCTION
Select a model number and add
EL (Fail Safe) - Electronically Locked
EU (Fail Secure) - Electronically Unlocked

VOLTAGE
12 or 24 Volts must be specified

OPTIONAL SWITCHES
REE-Request-to-Enter

FOR COMPLETE TRIM ONLY

TRIM

 - Tubular  - Straight
 - Bent  - Curved

FINISH (BHMA std)
626 - Satin Chrome
SPECIAL ORDER
613 - Oil Rubbed Bronze 625 - Polished Chrome

KEYWAY
Only ET15/25 have cylinder provided.
Rim Cylinder - "C" Standard
LC - Less Cylinder

ACCESSORIES
CRU2 - Current Reduction Unit (AC & DC input)
4 Lead - 4' Wire Lead to switches
10 Lead - 10' Wire lead to switches
QC - Molex Connectors
BR1 - Bridge Rectifier w/ 12" lead (included)
BR5 - Bridge Rectifier w/ 5' lead

EXAMPLES

MODIFICATION ONLY

	PREFIX	MODEL	FUNCTION	SUFFIX	VOLTAGE	FINISH	KEYWAY	OPTIONS	ACC	COMPLETE PART #
Part #	MD	CR22	CRU2	-	12	-	-	-	CRU2	MDCR22 EL CRU2
List \$	-	\$186	-	-	-	-	-	-	\$36	\$222

COMPLETE EXIT TRIM

	PREFIX	MODEL	FUNCTION	SUFFIX	VOLTAGE	FINISH	KEYWAY	OPTIONS	ACC	COMPLETE PART #
Part #	-	V96	EU	06	-	626	SFIC	REE	-	V96 EU 06 24V REE
List \$	-	\$865	-	-	-	-	-	\$63	-	\$928

QUICK REFERENCE

EXIT TRIM	PAGE	EXIT TRIM	PAGE	EXIT TRIM	PAGE
COMMAND ET15/16	22	FALCON	24	SARGENT	24
COMMAND ET25/26	23	HAGER	24	VON DUPRIN	24
CAL ROYAL	24	PRECISION	24	ACCESSORIES	25



ELECTRIFIED EXIT TRIM

COMMAND ACCESS ET15/16 SERIES

Works with Command Access PD15/16, Jackson 1285/95, & AHT 8000/9000 series



- FIELD REVERSIBLE HANDING
- PERFECT FOR APPLICATIONS WHERE LATCH RETRACTION OF THE EXIT DEVICE'S LATCHBOLT(S) IS COST PROHIBITIVE OR NOT REQUIRED.
- HIGHEST QUALITY MANUFACTURING BUILT TO LAST IN YORBA LINDA, CA
- ELECTRIC LOCKING OR UNLOCKING BY A REMOTE SWITCH
- INTERIOR OR EXTERIOR ENTRANCE (INGRESS) WITH MECHANICAL EXIT DEVICE
- IDEAL WHERE FIRE/LIFE SAFETY CODES REQUIRE A "FAIL SAFE" CONDITION
- STAIRWAY CONDITIONS
- NO NEED FOR EXPENSIVE POWER SUPPLY

MODELS	FUNCTION	LEVERS	FINISHES	DIMENSIONS
• ET15 RIM EU/EL	ELECTRIFIED STOREROOM w/ Key Override	 L6	628	Diameter
• ET15 CVR EU/EL	ELECTRIFIED STOREROOM w/ Key Override		313	
• ET16 RIM	ENTRANCE			
• ET16 CVR	ENTRANCE			

Complete Example: ET15 RIM EU L6 12V 628

COMMAND ACCESS ET15

Specify EU or EL, Voltage and Handing.

PART #	COMPLETE LOCK List \$		628	313	C	Request to Enter (REE)
ET15/16 for: Command Access PD15 Jackson 1285/95 AHT 8000/9000						
ET15RIM EU/EL	\$434	L6	✓	✓	✓	+\$63
ET15CVR EU/EL	\$434	L6	✓	✓	✓	+\$63
ET16 RIM	\$233	L6	✓	✓	✓	+\$63
ET16 CVR	\$233	L6	✓	✓	✓	+\$63

✓ or \$ = Available
- = Not Available



NEED A LOCKING HARDWARE POWER SUPPLY? PG 42

Command Access is not a licensee or affiliated, associated or connected with Allegion, Assa Abloy, Dorma, Stanley Security, Adams Rite, Arrow, Corbin Russwin, McKinney, Pemko, Rixson, Sargent, Yale, Dor-O-matic, Falcon, Ives, Monarch, Schlage, Von Duprin, Best, Precision, Accurate, AHT, Baldwin, Bommer, Cal Royal, CR Laurence, Design Hardware, Emtek, First Choice, FSB, General Lock, Hager, Jackson, Keedex, Lawrence, LSDA, Marks, Marshal-Best, Molex, Omnia, PBB, PDQ, or any of their subsidiaries or affiliates.

COMMAND ACCESS ET25/26 SERIES

Works with Command Access PD25/26, Cal Royal 7700 R/SVR, & Von Duprin 98/99 R/V series

- AVAILABLE 11-30V, FIELD SELECTABLE EU/EL
- FIELD REVERSIBLE HANDING
- PERFECT FOR APPLICATIONS WHERE LATCH RETRACTION OF THE EXIT DEVICE'S LATCHBOLT(S) IS COST PROHIBITIVE OR NOT REQUIRED.
- HIGHEST QUALITY MANUFACTURING BUILT TO LAST IN YORBA LINDA, CA
- ELECTRIC LOCKING OR UNLOCKING BY A REMOTE SWITCH
- INTERIOR OR EXTERIOR ENTRANCE (INGRESS) WITH MECHANICAL EXIT DEVICE
- IDEAL WHERE FIRE/LIFE SAFETY CODES REQUIRE A "FAIL SAFE" CONDITION
- STAIRWAY CONDITIONS
- NO NEED FOR EXPENSIVE POWER SUPPLY





MODELS FUNCTION LEVERS FINISHES DIMENSIONS

MODELS	FUNCTION	LEVERS	FINISHES	DIMENSIONS
ET25 EU/EL	ELECTRIFIED STOREROOM w/ Key Override	 L6	628	Diameter
<i>Mechanical</i>			313	2-3/4" x 10-1/4"
ET26 ELT	ENTRANCE LEVER TRIM		<i>Complete Example: ET25 EU L6 626</i>	
ET26 SLT	STOREROOM LEVER TRIM			
ET26 PLT	PASSAGE LEVER TRIM			
ET26 DLT	DUMMY LEVER TRIM			
ET26 ETT	ENTRANCE THUMB PIECE TRIM			
ET26 STT	STOREROOM THUMB PIECE TRIM			
ET26 PTT	PASSAGE THUMB PIECE TRIM			
ET26 DTT	DUMMY THUMB PIECE TRIM			
ET26 NPT	MECHANICAL NIGHT LATCH PULL TRIM			
ET26 DPT	DUMMY PULL TRIM			



√ or \$ = Available
- = Not Available

COMMAND ACCESS ET25

Specify EU or EL and Handing.

PART #	COMPLETE LOCK List \$			626	613	*C	Request to Enter (REE)
ET25 EU/EL	\$453	L6	L17	✓	✓	✓	+\$63
ET26 ELT	\$434	L6	L17	✓	✓	✓	+\$63
ET26 SLT	\$270	L6	L17	✓	✓	✓	+\$63
ET26 PLT	\$270	L6	L17	✓	✓	-	+\$63
ET26 DLT	\$270	L6	L17	✓	✓	-	-

ET25/26 for: Von Duprin 98/99 Command Access PD25 Cal-Royal 77

PART #	COMPLETE LOCK List \$			626	613	C
ET26 ETT	\$238	-	-	✓	✓	✓
ET26 STT	\$238	-	-	✓	✓	✓
ET26 PTT	\$238	-	-	✓	✓	-
ET26 DTT	\$238	-	-	✓	✓	-
ET26 NPT	\$160	-	-	✓	✓	✓
ET26 DPT	\$160	-	-	✓	✓	-

ET25/26 for: Von Duprin 98/99 Command Access PD25 Cal-Royal 77

*IC CORES AVAILABLE - CALL FACTORY FOR PRICING & AVAILABILITY



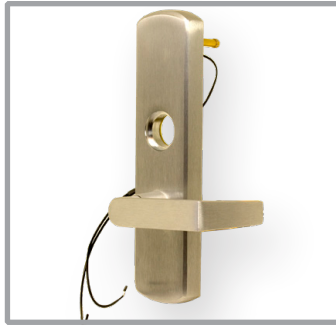

ELECTRIFIED EXIT TRIM



ELECTRIFIED OUTSIDE EXIT TRIMS

Specify EU or EL, Voltage and Handing.

✓ or \$ = Available
 - = Not Available

PART #	EXIT TRIM	COMPLETE LOCK List \$	MODIFICATION ONLY List \$ (add prefix MD)			626	LC	MAINTAIN KEY OVERRIDE	Request to Enter (REE)
CR22E U/EL	CAL ROYAL NESC 2200 R/SVR SERIES	-	\$217	-	-	-	-	✓	-
CR77 EU/EL	CAL ROYAL NESC 7700 R/SVR SERIES	-	\$217	-	-	-	-	✓	+\$63
CR98E U/EL	CAL ROYAL NESC 9800 R/SVR SERIES	-	\$217	-	-	-	-	✓	-
FAL581EU/51EL	FALCON 510 SERIES	-	\$217	-	-	-	-	✓	+\$63
H45CE EU/EL	HAGER 45CE SERIES	-	\$217	-	-	-	-	✓	-
PH49EU/EL*	PRECISION 4900 SERIES	-	\$500	-	-	-	-	-	-
SGT700EU/EL	SARGENT 713 SERIES	-	\$250	-	-	-	-	✓	+\$63
V23EU/EL	VON DUPRIN 230L SERIES	\$670	\$186	06	-	✓	✓	✓	-
V36EU/EL*	VON DUPRIN 360L/BE/T SERIES	-	\$500	-	-	-	-	-	-
V37EU/EL	VON DUPRIN 370L SERIES	-	\$500	-	-	-	-	✓	-
V96EU/EL	VON DUPRIN 996L R/V & M SERIES	\$865	\$186	06	17	✓	✓	✓	+\$63

Note: V36 & MDPH49 do not maintain key override- A dummy cylinder will be added to all cylinder prep trims.

ACCESSORIES



NOTES

ACCESSORIES & REPLACEMENTS FOR EXIT TRIM

VDREEKIT-ET	Field installable Request to Enter kit for the Von Duprin 996L Series	\$74
SGTREEKIT-ET	Field installable Request to Enter kit for the Sargent 713 Series	\$74
CRU	Current Reduction Unit	\$63
4' LEAD	Add 4' lead to any switch (per switch)	\$17
10' LEAD	Add 10' lead to any switch (per switch)	\$38
BR5	Bridge Rectifier w/ 5' Lead	\$28
QC or CON	8-pin or 12-pin Molex Connectors added to locking device retrofit ElectroLynx or Allegion Connect	\$42
QC or CON w/ lead	8-pin or 12-pin Molex Connectors w/3-5' lead added to locking device retrofit ElectroLynx or Allegion Connect	\$74
Door Cord QC or CON	3-5' Door Cord to connect a QC prepped locking device to the power transfer hinge	\$85
SOL-ET	Exit Trim Lock Replacement Solenoids (Specify brand, EU or EL & Voltage) - Call Factory to confirm field swap is available	\$85

* Please call to confirm replacement solenoid can be replaced in the field Allegion Connect® is a registered trademark of Allegion
ElectroLynx® is a registered trademark of Assa Abloy

molex



Micro-Fit 3.0™ Interconnect System available to retrofit common quick connection systems such as ElectroLynx® or Allegion Connect®.

NEED A LOCKING HARDWARE POWER SUPPLY? PG 42

RECOMMENDED LOCKING HARDWARE POWER SUPPLIES:

- PS202/202B
- PS204/PS204B
- PS210
- PS220/220B
- PS440B
- PS480B
- PS1



ELECTRIFIED LATCH RETRACTION

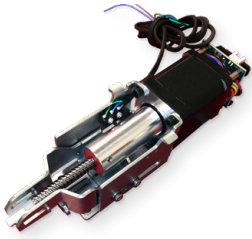

Years ago in the industry, using motors for latch pullback devices resulted in slow performance and consistent failures. For the over ten years Command Access has pioneered motorized latch retraction taking them to a new level that allows for a fast, quiet, smooth, and consistent latch retraction. Each motor assembly is designed specifically for the device, rather than taking a “one size fits all” approach.

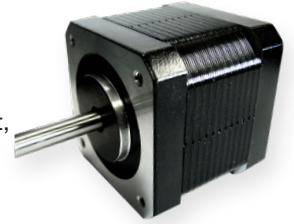

In addition, we now offer the new motor module with our patent pending “PTS” push-to-set technology, & 3 different energy consumption settings from energy conscious to heavy output to get the tough jobs done!

Here is what’s great about our “PTS” technology. While we aim to set every exit device correctly at the factory prior to shipping, we cannot account for every condition of every door opening in the field. Instead of our customers having to make several trips out to a job site to re-adjust an exit device, the device can be adjusted at the door by virtually anyone with a credential. After the proper location is set there is switch to lock programming in place to avoid accidental resetting from occurring. Here’s how “PTS” works in three easy steps;

- **Step 1 – press the device push pad to the desired setting. (this can be fully depressed or less than fully depressed)**
- **Step 2 – while depressing the push pad, activate the device. (i.e. presenting the credential to the reader)**
- **Step 3 - continue to keep pad depressed, the device will beep 6 times. After the beeps have stopped, release the pad and now the adjustment is complete. If not to your liking repeat the three steps.**
- **Step 4 - Once you’ve found the desired position, flip the switch on the Module to lock PTS programming.**

TYPICAL LATCH RETRACTION INSTALLATION FLOW CHART

A typical Command Access latch retraction device installation includes the device, the power transfer, and a power supply. The access control company integrates their card reader and controller to send a signal to the power supply that in turn unlocks the device (see example to the right). More advanced installations additionally incorporate auto operators and palm buttons for ADA/Barrier Free and hospital applications (see page 7 for an installation flow example).

APPLICATIONS INCLUDE:

- Hospital entrances and hallways
- Universities and institutions
- ADA compliance
- Barrier Free compliance

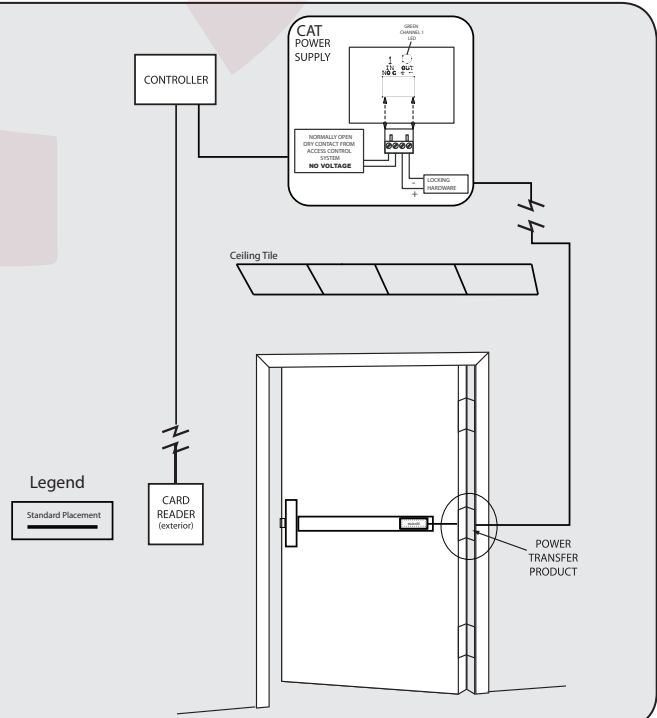

ELECTRIFIED EXIT DEVICES & KITS

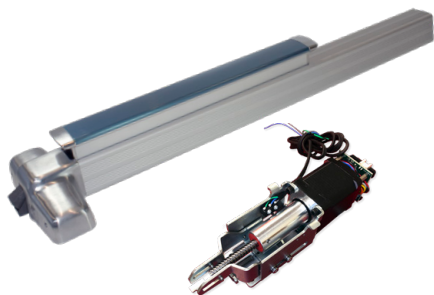

- **UL LISTED**
- **OPTIONAL REX ADD-ON**
- **QUICK & EASY INSTALLS WITH STEP BY STEP VIDEOS TO HELP**
- **WE'VE TESTED OUR LATCH PULLBACK DEVICES TO OVER 2 MILLION CYCLES!**
- **LONG WIRE RUNS WITH 18/2 WIRE TO POWER SUPPLY, SAVES COST.**
- **LOW CURRENT DRAW- SOLENOID ~1.5 AMPS; MOTORIZED ~1.0 AMP**
- **6' CABLE WITH QUICK CONNECT**
- **3-YEAR "NO HASSLE" WARRANTY ISSUES RELIABILITY TO THE OWNER**

ELECTRIFIED LATCH RETRACTION KITS

SPECIFICATIONS

MOTORS – Motor driven drive pulls back the exit device latch/latches from the locked position.

- Fast, quiet and smooth operation - You'll feel the difference!
- MM module is compatible with most 24VDC, 1A (or greater) regulated & filtered power supplies
- Electric dogging - Full push-pad retraction - Quieter operation in electronically dogged state.
- Push to Set "PTS" technology for easy post-installation electronic adjustment.
- Vandal Resistance - If push pad is pulled from open position, motor will re-set itself & pull back the latch without fail
- Adjustment screw for easy Electronic latchbolt adjusting.
- On-board audible self diagnostics for fast & easy troubleshooting at the opening.

When retrofitting our MLRK1 kit onto a device over 10 years old , please call factory for compatibility.

SOLENOIDS – Solenoid driven drive pulls back the exit device latch/latches from the locked position.

- Extended duration latch pullback capability for "continuously on conditions".
- Includes the patented PM300 interface power modules programmed to maximize the efficiency and life of the solenoid.
- Up to 500' wire run with 18/2 wire to power supply, saves cost.
- New optional switch for "High Output" mode.
- Loud activation provides audible confirmation door is unlocked.

FUNCTIONS

EU (FAIL SECURE) – Exit device latch(es) retracted with switched power allowing for outside access or auto operator integration. Without power, the device and latch(es) are secured (locked). Inside push pad always allows for free egress.

HOW TO ORDER

	MODEL	FUNCTION	VOLTAGE	OPTIONS		COMPLETE PART #
Part #	MLRK1-VD	EU	24V	REX	→	MLRK1-VD
List \$	\$530	-	-	N/C	→	\$530
Part #	MLRK1-AR	EU	24V	REX		MLRK1-AR REX
List \$	\$530	-	-	\$63		\$593

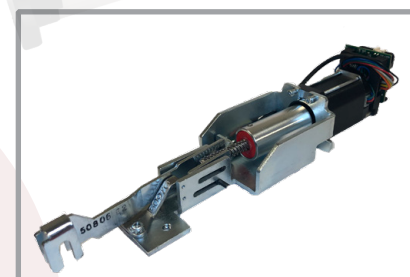
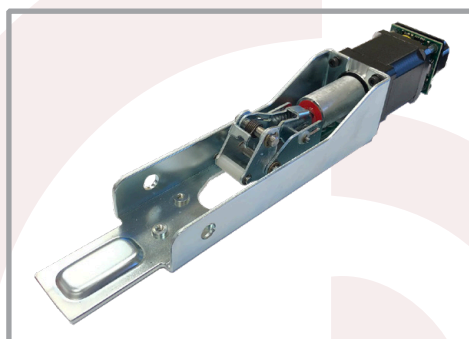

MOTORIZED LATCH RETRACTION KITS

Kits work on all style devices: RIM, SVR, CVR, & Mortise.

✓ or \$ = Available
- = Not Available

PART #	OLD PART #	EXIT DEVICE	LIST	BUILT-IN REX	REXKIT AVAILABLE ¹
MLRK1-AR	ARLP-UL-M-KIT	ADAMS RITE 82/84/86/88 SERIES	\$530	+\$63	\$74
MLRK1-AREX	EXARLP-UL-M-KIT	ADAMS RITE EX SERIES	\$530	+\$63	\$74
MLRK1-ARW	-	Arrow 1000/3000/4000 series	\$530	-	\$74
MLRK1-CAL	CRLP98-UL-M-KIT	CAL ROYAL 22 & 98 SERIES	\$530	-	\$74
MLRK1-CAL77	CRLP77-UL-M-KIT	Cal Royal 7700 series	\$530	+\$63	-
MLRK1-COR	CYLP-UL-M_KIT	CORBIN RUSSWIN 4000/5000	\$530	+\$63	\$74
MLRK1-DH	-	Design Hardware 1000	\$530	+\$63	\$74
MLRK1-DRX	CRLP98-UL-M-KIT	DOREX 9500 SERIES	\$530	-	\$74
MLRK1-DOR	DLP-UL-M-KIT	DORMA 9000 SERIES	\$530	-	\$74
MLRK1-FAL17	PD10-UL-M-KIT	Falcon 16/17 & First Choice 36/37 Series	\$530	✓	\$74
MLRK1-FAL25	FLP-UL-M-KIT	Falcon 24/25 series	\$530	✓	\$74
MLRK1-HAG	LLP-UL-M-KIT	Hager 4500 series	\$530	+\$63	\$74

1. See page 37 for REXKIT's available & part #. Order REX Kit separately.



ELECTRIFIED LATCH RETRACTION KITS

MOTORIZED LATCH RETRACTION KITS

Kits work on all style devices: RIM, SVR, CVR, & Mortise.

✓ or \$ = Available
- = Not Available

PART #	OLD PART #	EXIT DEVICE	LIST	BUILT-IN	REXKIT
				REX	AVAILABLE ¹
MLRK1-JAC12	PD15-UL-M-KIT	Jackson 1285/1295	\$530	+\$63	\$74
MLRK1-JAC12	PD15-UL-M-KIT	Kawneer 1686/1786	\$530	+\$63	\$74
MLRK1-LSDA1	-	LSDA 9000 series	\$530	+\$63	\$74
MLRK1-LSDA2	-	LSDA9200 R/V series	\$530	+\$63	\$74
MLRK1-MRK	MLP-UL-M-KIT	Marks M9900/8800	\$530	+\$63	\$74
MLRK1-PDQ	-	PDQ 6200 series	\$530	+\$63	\$74
MLRK1-PHI	EDLP1-UL-M-KIT	PHILADELPHIA HARDWARE 9000 SERIES	\$530	+\$63	\$74
MLRK1-TEL	EDLP1-UL-M-KIT	TELL 9500 SERIES	\$530	+\$63	\$74
MLRK1-TS	EDLP1-UL-M-KIT	Townsteel 1000 series	\$530	+\$63	\$74
MLRK1-SGT	SLP-UL-M-KIT	Sargent 80 series	\$530	-	\$74
MLRK1-SQ	-	Stanley QED 100/200	\$530	-	\$74
MLRK1-VD22	VLP22-UL-M-KIT	Von Duprin 22 series	\$530	✓	\$74
MLRK1-VD	VLP-UL-M-KIT	Von Duprin 33/35 & 98/99 series	\$530	✓	\$74

1. See page 37 for REXKIT's available & part #. Order REX Kit separately.

SOLENOID LATCH RETRACTION KITS

PART #	EXIT DEVICE	LIST	REXKIT
			AVAILABLE
ARLP88-KIT	Adams Rite 8800 series	\$210	+\$74
VLP-UL-KIT	Von Duprin 33/35 & 98/99 series	\$380	+\$74

NEED A LOCKING HARDWARE POWER SUPPLY? PG 42

RECOMMENDED LOCKING HARDWARE POWER SUPPLIES:

- PS202/202B
- PS204/PS204B
- PS210
- PS220/220B
- PS440B
- PS480B
- PS1



QUICK REFERENCE

EXIT DEVICE	CAT NEW PART #	CAT OLD PART #
ADAMS RITE 82/84/86/88 SERIES	MLRK1-AR	ARLP-UL-M-KIT
ADAMS RITE EX SERIES	MLRK1-AREX	EXARLP-UL-M-KIT
Arrow 1000/3000/4000 series	MLRK1-ARW	-
CAL ROYAL 22 & 98 SERIES	MLRK1-CAL	CRLP98-UL-M-KIT
Cal Royal 7700 series	MLRK1-CAL77	CRLP77-UL-M-KIT
CORBIN RUSSWIN 4000/5000	MLRK1-COR	CYLP-UL-M-KIT
Design Hardware 1000	MLRK1-MRK	-
DOREX 9500 SERIES	MLRK1-DRX	CRLP98-UL-M-KIT
DORMA 9000 SERIES	MLRK1-DOR	DLP-UL-M-KIT
Falcon 16/17 SERIES	MLRK1-FAL17	PD10-UL-M-KIT
Falcon 24/25 SERIES	MLRK1-FAL25	FLP-UL-M-KIT
First Choice 36/37 Series	MLRK1-FAL17	PD10-UL-M-KIT
Hager 4500 series	MLRK1-HAG	LLP-UL-M-KIT
Jackson 1285/1295	MLRK1-JAC12	PD15-UL-M-KIT
Kawneer 1686/1786	MLRK1-JAC12	PD15-UL-M-KIT
LSDA 9000 series	MLRK1-LSDA1	-
LSDA9200 R/V series	MLRK1-LSDA2	-
Marks M9900/8800	MLRK1-MRK	MLP-UL-M-KIT
PDQ 6200 series	MLRK1-PDQ	-
PHILADELPHIA HARDWARE 9000 SERIES	MLRK1-PHI	EDLP1-UL-M-KIT
TELL 9500 SERIES	MLRK1-TEL	EDLP1-UL-M-KIT
Townsteel 1000 series	MLRK1-TS	EDLP2-UL-M-KIT
Sargent 80 series	MLRK1-SGT	SLP-UL-M-KIT
Stanley QED 100/200	MLRK1-SQ	-
Von Duprin 22 series	MLRK1-VD22	VLP22-UL-M-KIT
Von Duprin 33/35 & 98/99 series	MLRK1-VD	VLP-UL-M-KIT
Yale 7000 Series	MRK1-COR	CYLP-UL-M-KIT
Yale 6000 Series	MLRK1-YAL6	-





ELECTRIFIED EXIT DEVICES



- **STOREFRONT & ARCHITECTURAL EXIT DEVICES ALLOW FOR REMOTE KEYLESS ACCESS CONTROL IN HIGH OCCUPANCY/HIGH TRAFFIC CONDITIONS**
- **COMMON APPLICATIONS INCLUDE CONDITIONS SUCH AS HOSPITALS, AIRPORTS, SCHOOLS, CHURCHES, AND AUTOMATIC DOOR OPERATORS**
- **WE STOCK MANY TYPES OF COMMAND ACCESS & OTHER MANUFACTURER'S EXIT DEVICES.**
- **3-YEAR "NO HASSLE" WARRANTY ISSUES RELIABILITY TO THE OWNER**

SPECIFICATIONS

MOTORS - Motor driven drive pulls back the exit device latch/latches from the locked position.

- Fast, quiet and smooth operation - You'll feel the difference
- MM module is compatible with most 24VDC, 1A (or greater) regulated & filtered power supplies
- Electric dogging - Full push-pad retraction
- "PTS" Electronic adjustment for latchbolt travel.
- If push pad is pulled from open position, motor will re-set itself & pull back the latch without fail
- Adjustment screw for easy Electronic latchbolt adjusting.
- On-board audible self diagnostics for fast & easy troubleshooting at the opening.



SOLENOIDS - Solenoid driven drive pulls back the exit device latch/latches from the locked position.

- Extended duration latch pullback capability for "continuously on conditions"
- Includes the patented PM300 interface power modules programmed to maximize the efficiency and life of the solenoid
- Up to 700' wire run with 18/2 wire to power supply, saves cost.
- New optional switch for "High Output" mode.
- Loud activation provides audible confirmation door is un-locked

TYPES

RIM - Rim type exit device with surface mounted push pad and one point latching.

SVR - Surface Vertical Rod type exit device with surface mounted push pad and two-point latching.

CVR - Concealed Vertical Rod type exit device with surface mounted push pad and two-point locking.

MORTISE - Mortise pocket installed exit device with surface mounted push pad and one-point locking.

FUNCTIONS

LPEU (FAIL SECURE) - Exit device latch(es) retracted with switched power allowing for outside access or auto operator integration. Without power, the device and latch(es) are secured (locked). Inside push pad always allows for free egress.

HOW TO ORDER

ALWAYS HERE TO HELP

FOR MODIFICATION AND COMPLETE DEVICE

PREFIX MD - Modification
MODEL + FUNCTION Select a model number and add EU (Fail Secure) - Electronically Unlocked only
VOLTAGE 24 Volts only
OPTIONAL SWITCHES REX - Request-to-Exit LBM - Latchbolt Monitor

FOR COMPLETE DEVICE ONLY

SIZE (Width of device) 36 - 36" wide device 42 - 42" wide device 48 - 48" wide device	
FINISH	
ARCHITECTURAL 626 - Satin Chrome 613 - Oil Rubbed Bronze	STOREFRONT 628 - Aluminum 313 - Duronatic
ACCESSORIES 3' Lead - 3' Wire Lead w/ connector(s) 4' Lead - 4' Wire Lead w/ connector(s) QC - Molex Connectors	

EXAMPLES

KEY: MD = MODIFICATION
M = MOTOR DRIVEN

MODIFICATION ONLY - SOLENOID DRIVEN

	PREFIX	MODEL	SUFFIX	FUNCTION	VOLTAGE	SIZE	FINISH	OPTIONS	COMPLETE PART #
Part #	MD	MDARLP86	-	EU	24V	-	-	REX	MDARLP86-EU-24V REX
List \$	-	\$381	-	-	-	-	-	\$63	\$444

COMPLETE MOTOR DRIVEN DEVICE

	PREFIX	MODEL	SUFFIX	FUNCTION	VOLTAGE	SIZE	FINISH	OPTIONS	COMPLETE PART #
Part #	-	PD25	M	EU	24V	36	626	REX	PD25-M-RIM-36-626 REX
List \$	-	\$1073	-	-	-	-	-	\$63	\$1136

QUICK REFERENCE

EXIT DEVICE	PAGE	EXIT DEVICE	PAGE	EXIT DEVICE	PAGE
COMMAND PD10/11	34	COMMAND PD22/23	35	ACCESSORIES	37
COMMAND PD15/16	34	COMMAND PD25/26	35		
COMMAND PD18/19	35	ADAMS RITE 86	36		



ELECTRIFIED EXIT DEVICES

COMMAND ACCESS STOREFRONT SERIES

The Command Access PD10, PD15, & PD18 storefront exit devices our high quality, cost effective solutions for new and retrofit storefront applications. As a retrofit solution, both devices easily convert other manufacturers installation to a Command Access latch pullback application. We recommend hardware be removed and replaced with new hardware utilizing existing holes' when selling device.



COMMAND ACCESS COMPLETE DEVICES PD10 / PD11

PD10 / PD11 Series retrofits Doromatic 1600/1700 & First Choice 3600/3700.

✓ or \$ = Available
- = Not Available

PART #	FUNCTION	LIST \$	36"	*42"	48"	ALUM	DURO	REX	LBM
PD10-M-RIM	Motorized Latch Retraction (EU)	\$815	✓	+\$63	+\$30	✓	+\$20	+\$63	+\$63
PD10-M-CVR	Motorized Latch Retraction (EU)	\$847	✓	+\$63	+\$30	✓	+\$20	+\$63	-
PD11-RIM	Mechanical	\$448	✓	+\$63	+\$30	✓	+\$20	+\$63	+\$63
PD11-CVR	Mechanical	\$478	✓	+\$63	+\$30	✓	+\$20	+\$63	-

*48" Device mechanics can be relocated at factory for 42" cut down.



COMMAND ACCESS COMPLETE DEVICE PD15 / PD16

PD15 / PD16 retrofits Jackson 1200 & AHT 8000/9000.
Please Specify Handing for CVR.

SEE PAGE 23 FOR COMPATIBLE
EXIT TRIM OPTIONS



PART #	FUNCTION	LIST \$	36"	42"	48"	ALUM	DURO	REX	LBM
PD15-M-RIM	Motorized Latch Retraction (EU)	\$813	✓	+\$30	+\$30	✓	✓	+\$63	-
PD15-M-CVR	Motorized Latch Retraction (EU)	\$847	✓	+\$30	+\$30	✓	✓	+\$63	-
PD16-RIM	Mechanical RIM Device	\$413	✓	+\$30	+\$30	✓	✓	+\$63	-
PD16-CVR	Mechanical CVR Device	\$434	✓	+\$30	+\$30	✓	✓	+\$63	-

*48" Device mechanics can be relocated at factory for 42" cut down.



COMMAND ACCESS COMPLETE DEVICE PD18 / PD19

PD18 / PD19 retrofits Adams Rite 8800 & 8600 series.

PART #	FUNCTION	LIST \$	36"	42"	48"	ALUM	DURO	REX	LBM
PD18-RIM*	Solenoid Latch Retraction (EU)	\$505	✓	+\$30	+\$30	✓	✓	+\$63	-
PD18-CVR	Solenoid Latch Retraction (EU)	\$764	✓	+\$30	+\$30	✓	✓	+\$63	-
PD18-M-RIM	Motorized Latch Retraction (EU)	\$840	✓	+\$30	+\$30	✓	✓	+\$63	
PD18-M-CVR	Motorized Latch Retraction (EU)	\$908	✓	+\$30	+\$30	✓	✓	+\$63	
PD19-RIM	Mechanical	\$360	✓	+\$30	+\$30	✓	✓	+\$63	-
PD19-CVR	Mechanical	\$430	✓	+\$30	+\$30	✓	✓	+\$63	-

*Available in 12V or 24V. Please specify when ordering

Command Access is not a licensee or affiliated, associated or connected with Allegion, Assa Abloy, Dorma, Stanley Security, Adams Rite, Arrow, Corbin Russwin, Mckinney, Pemko, Rixson, Sargent, Yale, Dor-O-matic, Falcon, Ives, Monarch, Schlage, Von Duprin, Best, Precision, Accurate, AHT, Baldwin, Bommer, Cal Royal, CR Laurence, Design Hardware, Emtek, First Choice, FSB, General Lock, Hager, Jackson, Keedex, Lawrence, LSDA, Marks, Marshal-Best, Molex, Omnia, PBB, PDQ, or any of their subsidiaries or affiliates.

COMMAND ACCESS ARCHITECTURAL SERIES

The Command Access PD20 architectural exit device series is a high quality, grade 1 solution for new and retrofit applications. This device is offered in numerous designs in both the 613 and 626 finish. As a retrofit solution, the PD25 standard template retrofits over Von Duprin 98/99 series & PD21 retrofits over the Von Duprin 33/35 series. In addition, the majority of the typical architectural devices on the market. If you need latch retraction in an architectural exit device application, the PD20 series offers a high quality and aesthetically pleasing design in a low cost package.



COMMAND ACCESS PD21/22

COMPLETE DEVICE

PD21 / PD22 Series retrofits Von Duprin 33/35 RIM & SVR.

✓ or \$ = Available
- = Not Available

PART #	FUNCTION	LIST \$						FIRE		
			36"	42"	48"	626	613	RATED	REX	LBM
PD21-M-RIM	Motorized Latch Retraction (EU)	\$1200	✓	-	+\$60	✓	-	-	+\$63	+\$63
PD21-M-SVR	Motorized Latch Retraction (EU)	\$1530	✓	-	+\$60	✓	-	-	+\$63	-
PD22-RIM	Mechanical RIM Device	\$650	✓	-	+\$60	✓	-	-	+\$63	+\$63
PD22-SVR	Mechanical SVR Device	\$900	✓	-	+\$60	✓	-	-	+\$63	-

- Extension Rods List \$75 for doors up to 10'

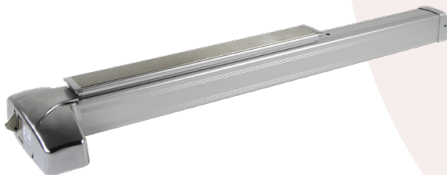

COMMAND ACCESS PD25/26

COMPLETE DEVICE

PD25 / PD26 Series retrofits Cal Royal 7700 & Von Duprin 98/99 RIM & SVR.

PART #	FUNCTION	LIST \$						FIRE		
			36"	42"	48"	626	613	RATED	REX	LBM
PD25-M-RIM	Motorized Latch Retraction (EU)	\$1073	✓	-	+\$30	✓	+\$50	+\$63	+\$63	+\$63
PD25-M-SVR	Motorized Latch Retraction (EU)	\$1299	✓	-	+\$30	✓	+\$50	+\$63	+\$63	-
PD26-RIM	Mechanical RIM Device	\$593	✓	-	+\$30	✓	+\$50	+\$63	+\$63	+\$63
PD26-SVR	Mechanical SVR Device	\$819	✓	-	+\$30	✓	+\$50	+\$63	+\$63	-

* Add suffix (F) for Fire Rated. Additional List \$100.
- Auxiliary Fire Bolt List \$85
- Extension Rods List \$75

SEE PAGE 26 FOR COMPATIBLE
EXIT TRIM OPTIONS





ELECTRIFIED EXIT DEVICES



ADAMS RITE MODIFICATION (Customer's Adams Rite 8000 Series Devices) Maintains factory dogging ability.

PART #	FUNCTION	LIST \$	REX	LBM
MDARLP82	Solenoid Latch Retraction (EU)	\$381	+\$63	-
MDARLP84	Solenoid Latch Retraction (EU)	\$381	+\$63	-
MDARLP86	Solenoid Latch Retraction (EU)	\$381	+\$63	-
MDARLP88*	Solenoid Latch Retraction (EU)	\$200	+\$63	-

✓ or \$ = Available
- = Not Available

*Available in 12V or 24V. Please specify when ordering

ACCESSORIES & REPLACEMENT FOR EXIT DEVICES

PART #	FUNCTION	LIST \$
8' Lead	8' Power Lead for Exit Devices	\$30
10' LEAD	Add 10' lead to any switch (per switch)	\$38
BR5	Bridge Rectifier w/ 5' Lead	\$28
QC or CON	8-pin or 12-pin Molex Connectors added to locking device retrofit ElectroLynx or Allegion Connect	\$42
QC or CON w/ lead	8-pin or 12-pin Molex Connectors w/3-5' lead added to locking device retrofit ElectroLynx or Allegion Connect	\$74
Door Cord QC or CON	3-5' Door Cord to connect a QC prepped locking device to the power transfer hinge	\$85
SOL-LP1	Replacement Solenoid Assembly for Electrified Latch Retraction - Single Coil	\$127
SOL-LP2	Replacement Solenoid Assembly for Electrified Latch Retraction - Dual Coil	\$127
SOL-LP3	Replacement Solenoid Assembly for Electrified Latch Retraction - Single Coil (12EU ARLP88)	\$127
SOL-LP4	Replacement Solenoid Assembly for Electrified Latch Retraction - Two-Solenoid Assembly	\$212
SOL-LP5	Replacement Solenoid Assembly for Electrified Latch Retraction - Single Coil (24EU ARLP88)	\$212

NOTES* See website for specific applications. ElectroLynx® is a registered trademark of Assa Abloy
ElectroLynx® is a registered trademark of Assa Abloy
Allegion Connect® is a registered trademark of Allegion

Micro-Fit 3.0™ Interconnect System available to retrofit common quick connection systems such as ElectroLynx® or Allegion Connect®.



EXIT DEVICE SWITCH OPTIONS

Command Access offers a variety of factory and field installable exit device monitoring switches. Each mechanical switch is SPDT (single pull, double throw) and capable of .5 amp @ 24 volts. Common applications employ these switches to monitor egress and device positioning to ensure the most secure assembly possible.

REX - Request to Exit switch - sends a signal to alert the control panel that the door is about to be opened by someone intending to exit from within the secured area. Field Installable REX (Request to Exit) switch kits are available for a variety of exit devices.

LBM - Latchbolt Monitor switch - sends a signal to the control panel to monitor the position of the latchbolt. Field Installable LBM (Latchbolt monitor) switch kits are available for exit devices.

EXIT DEVICE SWITCH OPTIONS

PART #	FUNCTION	LIST \$
REX	Add Request to Exit Switch to device	\$63
LBM	Add Latchbolt Monitor Switch to device	\$63
REX2	Add Double Request to Exit Switch to device	\$142

* Call Factory for specific device availability

SWITCH FIELD KITS FOR EXIT DEVICES

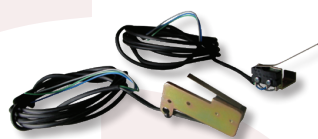

Switch Kit List \$	Mechanical Device	Solenoid Device	Motorized Device
--------------------	-------------------	-----------------	------------------

Part #	Function	Switch Kit List \$	Mechanical Device	Solenoid Device	Motorized Device
ARREXKIT-ED	Field Installable Request to Exit Kit for Adams Rite 8000 Series	\$74	✓	✓	-
ARREXKIT2-ED	Field Installable Double Request to Exit Kit for Adams Rite 8000 Series	\$142	✓	✓	-
ARREXKIT-M-ED	Field Installable Request to Exit Kit for MRLK1 Adams Rite Series	\$74	-	-	✓
CRSREXKIT-ED	Field Installable Request to Exit Kit for Cal Royal 22/98 & Sargent 80 Series	\$74	✓	-	✓
CRSREXKIT-M-ED	Field Installable Request to Exit Kit for MRLK1 Cal Royal 22/98 Series	\$74	-	-	✓
CYREXKIT-ED	Field Installable Request to Exit Kit for Corbin 4/5000 & Yale 7000 Series	\$74	✓	-	-
CYREXKIT-M-ED	Field Installable Request to Exit Kit for MRLK1 Corbin & Yale Series	\$74	-	-	✓
ED1REXKIT-M-ED	Field Installable Request to Exit Kit for MRLK1 Philadelphia & Tell Series	\$74	-	-	✓
ED2REXKIT-M-ED	Field Installable Request to Exit Kit for MRLK1 Series LSDA9200, USCAN2100, & Townsteel 1000 Series	\$74	-	-	✓
DORREXKIT-ED	Field Installable Request to Exit Kit for Dorma 9000 series	\$74	✓	✓	✓
MDHREXKIT-M-ED	Field Installable Request to Exit Kit for MRLK1 Marks M9900/8800 Series- MRLK1-MRK/DH Series	\$74	-	-	✓
LLPREXKIT-M-ED	Field Installable Request to Exit Kit for MRLK1-Hager, LSDA9000, Lawrence, PDQ Series	\$74	-	-	✓
PD10REXKIT-ED	Field Installable Request to Exit Kit for Falcon 16/17 & First Choice 36/37 Series	\$74	✓	✓	✓
PD10REXKIT-M-ED	Field Installable Request to Exit Kit for MRLK1 Falcon & First Choice Series	\$74	-	-	✓
PD15REXKIT-ED	Field Installable Request to Exit Kit for Jackson 1285/95 & Kawneer 16/17 Series	\$74	✓	-	-
PD15REXKIT-M-ED	Field Installable Request to Exit Kit for MRLK1 Jackson & Kawneer Series -	\$74	✓	-	✓
PD25REXKIT-ED	Field Installable Request to Exit Kit for PD25/26 & Cal Royal 7700 Series	\$74	✓	-	✓
PREREXKIT-ED	Field Installable Request to Exit Kit for Precision 2000 Series	\$74	✓	✓	-
VDREXKIT-ED	Field Installable Request to Exit Kit for Von Duprin 99/98 & 35/33 Series	\$74	✓	✓	✓
VDREXKIT-LC-ED	Field Installable Low Energy Request to Exit Kit for Von Duprin 99/98 & 35/33 Series	\$85	✓	✓	✓
VDREXKIT2-ED	Field Installable Double Request to Exit Kit for Von Duprin 99/98 & 35/33 Series	\$142	✓	✓	✓
VDLBMKIT-ED	Field Installable Latchbolt Monitor Kit for Von Duprin 99/98 & 35/33 Series	\$85	✓	✓	✓

MODULES & ACCESSORIES

PM300



The patented PM300 (taking over from all PM200 & PWM200 units) power booster module is an interface module that connects between the solenoid circuit of a latch-pullback exit device and the power supply.

PM300: Works with filtered & regulated power supplies.

PM300D: Built-in .5 second delay, works with filtered & regulated power supplies.

PM300AC: Works with unfiltered &/or unregulated power supplies.

PM300ACD: Built-in .5 second delay, works with unfiltered &/or unregulated power supplies.

- POWER BOOSTER MODULE PROVIDES LOCAL POWER BOOST TO SOLENOID DRIVEN LATCH PULLBACK DEVICES
- INCREASES WIRE RUNS UP TO 700' ON 2-18GA WIRES
- GIVES ANAEMIC POWER SUPPLY/EXIT DEVICE A BOOST - EXTENDING THE LIFE OF THE OPENING!
- WORKS WITH MOST 1.5A POWER SUPPLIES - ELIMINATES THE NEED FOR A EXPENSIVE "SPECIALITY" POWER SUPPLY
- PLUG & PLAY REPLACEMENT FOR THE VD POTTED CIRCUIT BREAKER

CRU2



- INCREASED SOLENOID LIFE
- IMPROVED EFFICIENCY FOR CONTINUOUS DUTY APPLICATIONS
- SOLVES "WARM" LEVERS ON EL (FAIL SAFE) OPENINGS
- SIGNIFICANT ENERGY \$\$ SAVINGS WHEN USED ON CONTINUOUS DUTY APPLICATIONS
- HOLDING CURRENT AS LOW AS 40 MA
- HIGH FREQUENCY PULSE SENT TO ENSURES NO SOLENOID DROPOUT

VC2412



- CONVERTS 24VDC TO OUTPUT 12VDC
- WORKS WITH ANY 24VDC POWER SOURCE
- EURO CONNECTOR ON 12VDC SIDE
- MAY ELIMINATE NEED FOR ADDITIONAL 12VDC POWER SOURCE
- POWERS LOCKING DEVICES, PRI'S, CARD READERS, CAMERAS & MORE



CAT-AIR-REX

The CAT AIR REX uses focused active infrared to provide the most accurate detection of someone exiting a secured area. AIR-REX focuses right on the door handle solving the issues experienced with standard PIR's: hot air, background objects, & cross traffic.

- ADJUSTABLE .5-60 SECOND TIME DELAY
- ADJUSTABLE DETECTION FROM 20-48"
- BUILT-IN SOUNDER TO WORK IN CONJUNCTION WITH DOOR POSITION
- MULTIPLE RE-LOCKING MODES FOR TIMED OR DOOR POSITION CONDITIONS
- 3 DRY CONTACT INPUTS FOR REX, CARD READER, & PUSH BUTTON
- OUTPUT SINGLE POLE DOUBLE THROW
- LED INDICATORS



IDPS

The IDPS series are independent recessed door contacts for high security applications.

IDPS-1 : 3/4" Diameter standard door contact

IDPS-2 : 1" Diameter for high security applications

IDPSC-1 : 4-7/8" for vandal resistance applications

- SINGLE POLE DOUBLE THROW SWITCHES
- RARE EARTH MAGNETS
- IDPS1/2: AVAILABLE IN WHITE & BROWN
- IDPSC-1: BRUSHED STAINLESS STEEL, CORROSION RESISTANT
- SELF LOCKING INTO STEEL & WOOD
- IDEAL FOR ADDING DPS TO EXISTING OPENING OR WHEN DPS INTEGRATED INTO LOCKING HARDWARE IS NOT AVAILABLE

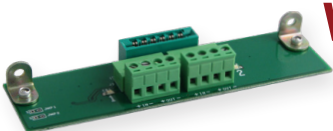

VD2

- VD2-873 RETROFIT BOARD FOR DISCONTINUED VD873 RELAY BOARD (871-2 CARD)
- VD2-914 RETROFIT BOARD FOR DISCONTINUED VD873 RELAY BOARD (2RS CARD)
- MOUNTS UP TO EXISTING SCREW HOLES - NO NEED TO PURCHASE A WHOLE NEW POWER SUPPLY
- EURO CONNECTOR FOR EASY WIRING VS SCREW TERMINALS



MODULES & ACCESSORIES

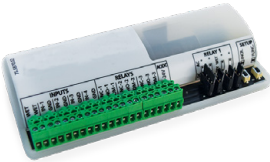

DS1-X

- 13 PROGRAMMABLE FUNCTIONS INCLUDING: SEQUENCING MODES, TIMER FUNCTIONS, AND TELEPHONE ENTRY SYSTEMS
- 3 ADJUSTABLE TIMER RELAYS, UP TO 60 SECONDS MAXIMUM
- TWO 3-AMP AND ONE 1-AMP RELAYS, ALL WITH BUILT-IN SURGE SUPPRESSION
- SPDT CONTACTS RATED AT 3 AMPS @ 30VDC
- IDEAL FOR LATCH PULLBACKS ON AUTO OPERATOR OPENINGS & PRIVACY RESTROOM APPLICATIONS
- EASY PUSH BUTTON ADJUSTMENTS
- LEDS FOR VISUAL RELAY CONFIRMATION
- ACCEPTS WET OR DRY INPUTS
- 1 RELAY CAN PROVIDE WET OUTPUT WITH AC / DC VOLTAGE FOR POWERING AN ELECTRIC LOCKING DEVICE DIRECTLY FROM THE MODULE
- ONE SHOT DESIGN FOR SECURITY OR MAINTAINED OUTPUT FOR SMOKE EVACUATION.
- LED'S FOR VISUAL RELAY CONFIRMATION
- INPUT FOR CONNECTION FOR TELEPHONE ENTRY SYSTEM

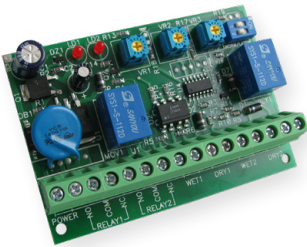

DS1

- BI-DIRECTIONAL SEQUENCING MODE
- 3 ADJUSTABLE DELAYS, UP TO 30 SECONDS MAXIMUM
- IDEAL FOR LATCH PULLBACKS ON AUTO OPERATOR OPENINGS
- EASY POTENTIOMETER ADJUSTMENTS
- LEDS FOR VISUAL RELAY CONFIRMATION
- ACCEPTS WET OR DRY INPUTS
- ONE SHOT DESIGN FOR SECURITY OR MAINTAINED OUTPUT FOR SMOKE EVACUATION
- SPDT CONTACTS RATED AT 3 AMPS @ 30VDC
- LED'S FOR VISUAL RELAY CONFIRMATION
- INPUT FOR CONNECTION FOR TELEPHONE ENTRY SYSTEM



FIELD TESTER - PORTABLE POWER SUPPLY

- LIGHT WEIGHT FIELD TESTER FOR ALL ELECTRIFIED HARDWARE
- GREAT FOR TESTING NEW INSTALLATIONS OR TROUBLESHOOTING PROBLEMATIC OPENINGS
- ENOUGH POWER TO FIRE OFF ELECTRIFIED LATCH RETRACTION SOLENOID DEVICE W/ PM300
- CORDLESS - NO NEED TO FIND AN OUTLET OR CARRY AN EXTENSION CORD
- ADJUSTABLE 11-28 VDC TO TEST ALL PRODUCTS REGARDLESS OF VOLTAGE
- BUILT-IN CONTINUITY TESTER WITH BEEPER & LED
- WORKS WITH DEWALT, MAKITA, & MILWAUKEE BATTERIES
- EQUIPPED WITH ALLIGATOR CLIPS & QUICK CONNECTS FOR CAT PRODUCTS

POWER MODULES & ACCESSORIES

CAT FT	COMPLETE FIELD TESTER, specify battery (DeWalt, Makita, Milwaukee)	\$260
CAT FT BASE	Field Tester Base without battery attachment	\$220
CAT FT ATTACHMENT	Battery Attachment, specify battery (DeWalt, Makita, Milwaukee)	\$40
CAT FT Dist Pack	15 - Field Tester Distributor Pack (Specify attachments)	\$3650
PM300	Power Module for Solenoids powered by DC Power sources	\$200
PM300-D	Power Module for Solenoids powered by DC Power sources w/ built-in .5 second delay	\$200
PM300-AC	Power Module for Solenoids powered by AC Power sources	\$200
PM300-ACD	Power Module for Solenoids powered by AC Power sources w/ built-in .5 second delay	\$200
MM Module	Replacement Motor Module (Specify device when ordering)	\$159
CRU2	Current Reduction Unit for solenoid powered Mortise & Cylindrical locks, Strikes & Exit Trim	\$49
VC2412	Voltage Converter 24VDC to 12VDC	\$42
DS1	Door Sequencer	\$165
DS1-X	Door Sequencer	\$190
CATMREX100	Active Infrared Request to Exit	\$218
IDPS1	Independent DPS switch installs in frame & alum (wood, hollow metal, & FRP)	\$30
IDPS2	Independent High Security DPS switch installs in frame & alum (wood, hollow metal, & FRP)	\$40
IDPSSC-1	Vandal Resistance Independent Concealed Magnetic Contact switch DPS switch installs in frame & alum (wood, hollow metal, & FRP)	\$84



POWER SUPPLIES

COMMAND ACCESS LOCKING HARDWARE POWER SUPPLY SERIES

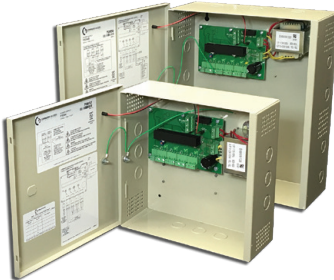

- BUILT TO RUN LOCKING HARDWARE - MOTORIZED/SOLENOID LP DEVICES, CYLINDRICAL/MORTISE LOCKS, & EXIT TRIM.
- ROBUST SOLID-STATE OUTPUTS - PROTECTS SYSTEM RELAYS
- INTERRUPTION FREE BATTERY-BACK UP
- LINEAR DESIGN ENSURES AMPLE IN-RUSH & HOLD CURRENT FOR LATCH PULLBACK APPLICATIONS
- DOOR MOUNTED LED POWER INDICATOR
- REMOVABLE EURO CONNECTORS -EASY WIRING FOR THE INSTALLER
- BUILT TO LAST IN THE USA



UL294 6TH EDITION LISTING

PS210	PS202/202B	
PS220/220B	PS204/204B	
PS440B		
PS480B		

POWER SUPPLIES

FOR ALL LATCH PULLBACK/EXIT DEVICES

PS210	1.5A, 24V regulated PS w/boost circuitry for up to (2) electric latch pullback devices. Includes (1) solid state input/output	\$250
PS220	2A, 24V regulated PS w/boost circuitry for up to (2) electric latch pullback devices. Includes (2) solid state inputs/outputs and a fire alarm link. (1) 24VDC Power Tap	\$311
PS220B	2A, 24V regulated PS w/boost circuitry for up to (2) electric latch pullback devices. Includes (2) solid state inputs/outputs, battery charging circuit, and a fire alarm link. (1) 24VDC Power Tap. Battery Back-up	\$368
PS440B	4A, 24V regulated PS w/boost circuitry is capable of powering up to (4) electric latch pullback devices. Includes (4) solid state inputs/outputs, battery charging circuit, and a fire alarm link. Battery Back-up	\$413
PS480B	4A, 24V regulated PS w/boost circuitry for up to (8) electric latch pullback devices. Includes (8) solid state inputs/outputs, battery charging circuit, and a fire alarm link. Battery Back-up	\$453

POWER SUPPLIES

FOR MOTORIZED LATCH RETRACTION, MORTISE/CYLINDRICAL LOCK, & EXIT TRIM

PS202	2A, 24V regulated PS w/boost circuitry for up to (4) MOTORIZED electric latch pullback devices. Includes (4) solid state inputs/outputs, and a fire alarm link	\$233
PS202B	2A, 24V regulated PS w/boost circuitry for up to (4) MOTORIZED electric latch pullback devices. Includes (4) solid state inputs/outputs, and a fire alarm link. Battery Back-up	\$290
PS204	2A, 24V regulated PS w/boost circuitry for up to (4) MOTORIZED electric latch pullback devices. Includes (4) solid state inputs/outputs, and a fire alarm link	\$275
PS204B	2A, 24V regulated PS w/boost circuitry for up to (4) MOTORIZED electric latch pullback devices. Includes (4) solid state inputs/outputs, and a fire alarm link. Battery Back-up	\$332

POWER SUPPLY MATRIX

PS LINE 24VDC	AMPERAGE (CONTINUOUS)	AMPERAGE (BOOST)	INPUTS	OUTPUTS	BATTERY BACK-UP	FIRE ALARM LINK	24V POWER TAP (CONSTANT POWER)	LOCKING HARDWARE (MORTISE /CYLINDRICAL LOCK/ EXIT TRIM)	LOCKING HARDWARE (MOTORIZED EXIT DEVICES)	LOCKING HARDWARE (SOLENOID EXIT DEVICE LPM/PM300HO)	METAL ENCLOSURE
PS210	1.5	2.5	1	1	-	✓	-	2	2	2	S
PS220	2	3	2	2	-	✓	✓	2	2	2	S
PS220B	2	3	2	2	✓	✓	✓	2	2	2	L
PS440B	4	6	4	4	✓	✓	-	4	4	4	L
PS480B	4	6	8	8	✓	✓	-	8	8	8	L
PS202	2	3	2	2	-	✓	-	2	2	-	S
PS202B	2	3	2	2	✓	✓	-	2	2	-	L
PS204	2	3	4	4	-	✓	-	4	4	-	S
PS204B	2	3	4	4	✓	✓	-	4	4	-	L

SMALL ENCLOSURE: 11" x 11" x 4"

LARGE ENCLOSURE: 13" x 15.5" x 5"

POWER SUPPLIES & AUXILIARY BOARDS

PS1-B0	Board Only to replace PS1 - 1A, 24V regulated power supply w/boost circuitry for up to (2) electric latch pullback devices. Includes (1) solid state input/output	\$212
PS2-B0	Board Only to replace the discontinued Von Duprin PS873-2 power supply - 2A, 24V regulated power supply w/boost circuitry. Includes (2) solid state inputs/outputs and a fire alarm link.	\$328
PS2BB-B0	Board Only to replace the discontinued Von Duprin PS873-2BB power supply - 2A, 24V regulated power supply w/boost circuitry. Includes (2) solid state inputs/outputs, battery charging circuit, and a fire alarm link.	\$385
PS-OP-2	Replacement Relay Board for PS202/202B/220/220B (Specify Series)	\$180
PS-OP-4	Replacement Relay Board for PS204/204B/440B (Specify Series)	\$190
PS-OP-8	Replacement Relay Board for PS480B	\$200
SW3	2.4A 27VDC regulated power supply w/ (3) non-fused outputs for electric strikes, mortise locks and cylindrical locks. **NOT UL LISTED**	\$174
VD2-873	2A, 24V regulated PS w/boost circuitry for up to (4) MOTORIZED electric latch pullback devices. Includes (4) solid state inputs/outputs, and a fire alarm link. Battery Back-up	\$190
VD2-914	2A, 24V regulated PS w/boost circuitry for up to (4) MOTORIZED electric latch pullback devices. Includes (4) solid state inputs/outputs, and a fire alarm link	\$190
DS1	Command Access delay/sequencer board for auto operator integration and door sequencing.	\$165
DS1-X	Command Access delay/sequencer board for auto operator integration and door sequencing.	\$190
BB12V7	Set of (2) 12VDC 7AH Batteries for Power Supplies with Battery Back-Up	\$160



POWER TRANSFER HINGES

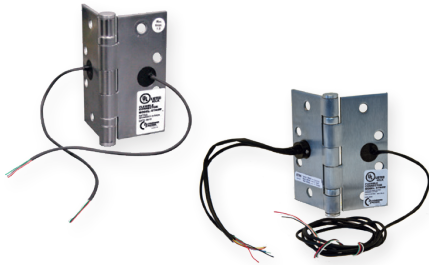

- 4' LEAD STANDARD - LESS POINTS OF FAILURE
- UL-F RATED & ACCEPTED IN THE "PERFECT RACEWAY" PROGRAM
- WIRE HEAVY COMBINATIONS FOR LATCH PULLBACK DEVICES - UP TO 12WH (2-20GA + 10-28GA)
- NON-CONDUCTIVE WIRE ACCESS CAP FOR BETTER PROTECTION
- CENTER TO CENTER PREP ON 5SW HINGES
- LARGE HINGE INVENTORY



ELEMENTS OF A PART NUMBER

TYPE		FINISH (Steel Base Metal)			
ETH - Energy Transfer Hinge ETM - Energy Transfer Monitor Hinge		600/P - Prime Coat 605-632/3 - Bright Brass 606-633/4 - Satin Brass 609-638/5 - Satin Brass Antique 611-637/9 - Bright Bronze 612-639/10 - Satin Bronze	641/10A - Antique Bronze Laq. 613-640/10B - Anti. Bronze Oil 619-646/15 - Satin Nickel 625-651/26 - Bright Chrome 626-652/26D - Satin Chrome 693/L1 - Black		
WIRES		FINISH (Brass Base Metal)			
M - Monitor Only	2WH - (2/18ga)	600/P - Prime Coat 605/3 - Bright Brass 606/4 - Satin Brass 609/5 - Satin Brass Antique 611/9 - Bright Bronze 612/10 - Satin Bronze	613/10B - Antique Bronze Oil 619/15 - Satin Nickel 625/26 - Bright Chrome 626/26D - Satin Chrome 693/L1 - Black		
2W - (2/20ga)	4WH - (2/18ga+2/26ga)	*NOT AVAILABLE ON ALL HINGES SIZES .			
4W - (4/26ga)	6WH - (2/18ga+4/28ga)				
6W - (6/26ga)	8WH - (2/20ga+6/28ga)				
8W - (8/28ga)	10WH* - (2/20ga+8/28ga)				
10W - (10/28ga)	12WH* - (2/20ga+10/28ga)				
12W - (12/28ga)					
SIZE / HANDING		FINISH (Stainless Steel Base Metal)			
4.0 x 4.0 (SQ or RC)	5.0 x 5.0	629 - Polished Stainless	630 - Brushed Stainless		
4.5 x 4.0 (SQ or RC)	4.5 x 6.0 (WT)	<th colspan="2">STYLE</th>		STYLE	
4.5 x 4.5	5.0 x 6.0 (WT)				
5.0 x 4.0	LH - Left Hand				
5.0 x 4.5	RH - Right Hand				
OPTIONS		3SW - 3 Knuckle Standard Weight	CATPIVOT - 3/4" Offset Pivot		
QC - Molex Connectors	HT - Hospital Tip (SS/Brass Only)	3HW - 3 Knuckle Heavy Weight	5SWSC - CAT Swingclear Standard weight (specify straight or bevelled)		
4' Leads - ALWAYS SUPPLIED AT NO CHARGE		5SW - 5 Knuckle Standard Weight			
		5HW - 5 Knuckle Heavy Weight			
		3/4" - offset pivot (top/intermediate)	PP - Pocket pivot (center hung)		
		1-1/2" - offset pivot (top/intermediate)	SC - Swing Clear Hinge		
		TP - Top pivot (center hung)	RB - Raised Barrel		

EXTRA HINGES FOR MODIFICATION

Due to the nature of the modification process, please send 1 extra hinge for every 8 to be modified. We will return any hinges not need back with your order.
For Example: 1-8 hinges, 1 extra | 9-16 hinges, 2 extra .

QUICK REFERENCE

HINGES	PAGE	HINGE	PAGE	HINGE	PAGE
ETH 5K	47	ETM 3K	50	PIVOTS	52
ETH 3K	48	SWING CLEAR	51	DOOR LOOP	53
ETM 5K	49	SPECIALTY HINGES	51		

HOW TO ORDER

ALWAYS HERE TO HELP

HOW TO MEASURE A HINGE REFERENCE

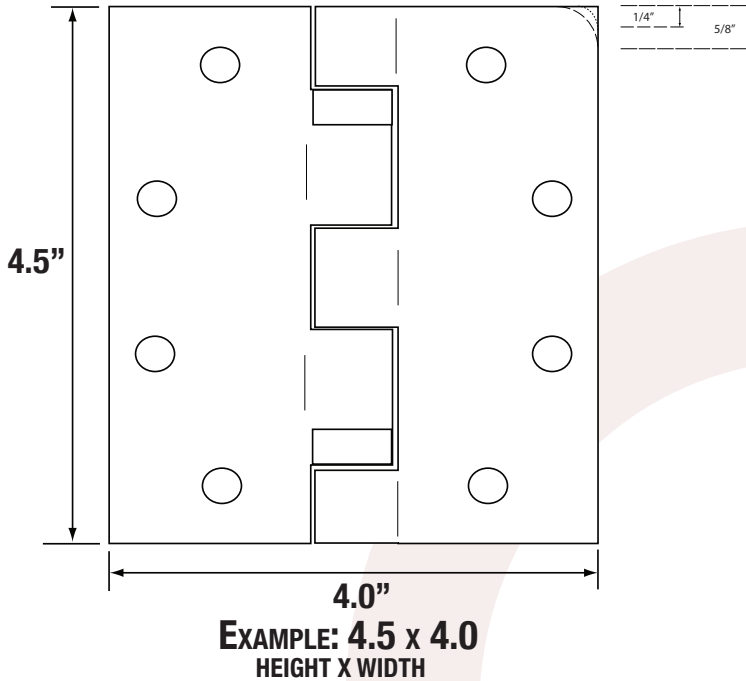

TYPES OF HINGES

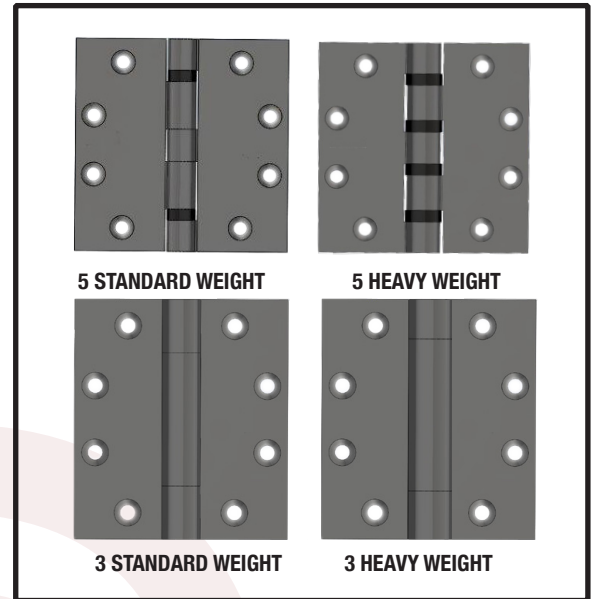

EXAMPLES

MODIFICATION ONLY - BUTT HINGE

	TYPE	WIRES	SIZE	BASE	STYLE	HANDING	OPTIONS	COMPLETE PART #
Part #	ETM	4W	4540	Steel	3SW	-	QC	ETM4WMOD Steel 3SW QC
List \$	-	\$203	-	-	-	-	\$42	\$245

COMPLETE ENERGY TRANSFER HINGE

	TYPE	WIRES	SIZE	FINISH	STYLE	HANDING	OPTIONS	COMPLETE PART #
Part #	ETH	8W	4545	626	5HW	-	4' Lead	ETH8W4545-626 5HW
List \$	-	\$195	-	-	-	-	N/C	\$195

MODIFICATION ONLY - PIVOT/SPECIALTY HINGE

	TYPE	WIRES	SIZE	BASE	STYLE	HANDING	OPTIONS	COMPLETE PART #
Part #	ETH	4W	45	Steel	SC	-	QC	ETM4WMOD Steel 3SW QC
List \$	-	\$254	-	-	-	-	\$42	\$294

COMPLETE ENERGY TRANSFER PIVOT

	TYPE	WIRES	SIZE	FINISH	STYLE	HANDING	OPTIONS	COMPLETE PART #
Part #	ETH	4WH	-	626	CATPIVOT	RH	4' Lead	ETH4WH-626-CATPIVOT RH
List \$	-	\$364	-	-	-	-	N/C	\$364

Micro-Fit 3.0™ Interconnect System available to retrofit common quick connection systems such as ElectroLynx® or Allegion Connect®.

www.commandaccess.com | US Customer Support 888.622.2377





POWER TRANSFER HINGES

HINGE CROSS REFERENCE SHEET

	COMMAND ACCESS	HAGER	STANLEY	MCKINNEY	PBB	IVES	CAL ROYAL	BOMMER
5 KNUCKLE - SW STEEL BASE	BB79	BB1279	FBB179 CB179	TA2714	BB81	BB5000	5BB1	BB31
5 KNUCKLE - SW BRASS BASE	BB91	BB1191	FB191 CB191	TA2314	BB21	BB5001	5BB1	SBB31
5 KNUCKLE - SW STAINLESS STEEL BASE	BB91	BB1191	FBB191 CB191	TA2314	BB51	BB5002	5BB1	BB31-630
5 KNUCKLE - HW STEEL BASE	BB68	BB1168	FBB168 CB168	T4A3786	4B81	BB5004	5BB1HW	BB5200
5 KNUCKLE - HW BRASS BASE	BB99	BB1199	FB199 CB199	T4A3385	4B81	BB5005	5BB1HW	N/A
5 KNUCKLE - HW STAINLESS STEEL BASE	BB99	BB1199	FBB199 CB199	T4A3385	4B21	BB5006	5BB1HW	BB5200-630
3 KNUCKLE - SW STEEL BASE	CB70	AB700	CB1900R	TA714	CB81	LB8000	3CB1	BB200
3 KNUCKLE - SW BRASS BASE	CB80	AB800	CB1960R	TA314	CB21	LB8001	3CB1	N/A
3 KNUCKLE - SW STAINLESS STEEL BASE	CB80	AB800	CB1960R	TA314	CB51	LB8002	3CB1	BB2200-630
3 KNUCKLE - HW STEEL BASE	CB75	AB750	CB1901R	TA786	4C81	LB8004	3CB1HW	BB3300
3 KNUCKLE - HW BRASS BASE	CB85	AB850	CB1961R	TA386	4C21	LB8005	3CB1HW	N/A
3 KNUCKLE - HW STAINLESS STEEL BASE	CB85	AB850	CB1961R	TA386	4C51	LB8006	3CB1HW	BB3300-630



5 KNUCKLE STANDARD TRANSFER HINGES - ETH

STEEL BASE (BB79)	2W	4W	6W	8W	10W	12W	2WH	4WH	6WH	8WH	10WH	12WH
4.0 x 4.0	\$122	\$122	\$144	\$154	\$180	\$190	\$169	\$186	\$186	\$203	\$222	\$232
4.5 x 4.0	\$122	\$122	\$144	\$154	\$180	\$190	\$169	\$186	\$186	\$203	\$222	\$232
4.5 x 4.5	\$122	\$122	\$144	\$154	\$180	\$190	\$169	\$186	\$186	\$203	\$222	\$232
5.0 x 4.5	\$144	\$144	\$161	\$180	\$203	\$213	\$186	\$203	\$203	\$222	\$246	\$256
5.0 x 5.0	\$165	\$165	\$182	\$203	\$224	\$234	\$207	\$224	\$224	\$246	\$267	\$277
BRASS BASE (BB91)	2W	4W	6W	8W	10W	12W	2WH	4WH	6WH	8WH	10WH	12WH
4.0 x 4.0	\$152	\$152	\$169	\$186	\$203	\$213	\$195	\$212	\$212	\$229	\$246	\$256
4.5 x 4.0	\$152	\$152	\$169	\$186	\$203	\$213	\$195	\$212	\$212	\$229	\$246	\$256
4.5 x 4.5	\$152	\$152	\$169	\$186	\$203	\$213	\$195	\$212	\$212	\$229	\$246	\$256
5.0 x 4.5	\$169	\$169	\$186	\$203	\$222	\$232	\$212	\$229	\$229	\$238	\$265	\$275
5.0 x 5.0	\$182	\$182	\$203	\$222	\$241	\$251	\$224	\$246	\$246	\$254	\$284	\$294
STAINLESS STEEL BASE (BB91)	2W	4W	6W	8W	10W	12W	2WH	4WH	6WH	8WH	10WH	12WH
4.0 x 4.0	\$169	\$169	\$186	\$203	\$238	\$248	\$212	\$229	\$229	\$246	\$280	\$290
4.5 x 4.0	\$169	\$169	\$186	\$203	\$238	\$248	\$212	\$229	\$229	\$246	\$280	\$290
4.5 x 4.5	\$169	\$169	\$186	\$203	\$238	\$248	\$212	\$229	\$229	\$246	\$280	\$290
5.0 x 4.5	\$186	\$186	\$203	\$222	\$254	\$264	\$229	\$246	\$246	\$265	\$296	\$306

5 KNUCKLE HEAVY TRANSFER HINGES - ETH

STEEL BASE (BB68)	2W	4W	6W	8W	10W	12W	2WH	4WH	6WH	8WH	10WH	12WH
4.5 x 4.0	\$161	\$161	\$178	\$195	\$212	\$222	\$203	\$220	\$224	\$237	\$254	\$264
4.5 x 4.5	\$161	\$161	\$178	\$195	\$212	\$222	\$203	\$220	\$224	\$237	\$254	\$264
5.0 x 4.5	\$178	\$178	\$195	\$212	\$229	\$239	\$220	\$237	\$241	\$254	\$271	\$281
5.0 x 5.0	\$190	\$190	\$207	\$224	\$241	\$251	\$233	\$250	\$254	\$267	\$284	\$294
BRASS BASE (BB99)	2W	4W	6W	8W	10W	12W	2WH	4WH	6WH	8WH	10WH	12WH
4.5 x 4.0	\$178	\$178	\$195	\$212	\$231	\$241	\$220	\$237	\$239	\$252	\$273	\$283
4.5 x 4.5	\$178	\$178	\$195	\$212	\$231	\$241	\$220	\$237	\$239	\$252	\$273	\$283
5.0 x 4.5	\$195	\$195	\$212	\$231	\$248	\$258	\$237	\$254	\$256	\$269	\$273	\$283
5.0 x 5.0	\$207	\$207	\$224	\$241	\$265	\$275	\$250	\$267	\$269	\$284	\$307	\$317
STAINLESS STEEL BASE (BB99)	2W	4W	6W	8W	10W	12W	2WH	4WH	6WH	8WH	10WH	12WH
4.5 x 4.0	\$203	\$203	\$212	\$231	\$258	\$268	\$241	\$254	\$256	\$271	\$301	\$311
4.5 x 4.5	\$203	\$203	\$212	\$231	\$258	\$268	\$241	\$254	\$256	\$271	\$301	\$311
5.0 x 4.5	\$212	\$212	\$231	\$246	\$273	\$283	\$254	\$271	\$273	\$288	\$315	\$325
5.0 x 5.0	\$224	\$224	\$241	\$258	\$286	\$296	\$267	\$284	\$286	\$301	\$328	\$338

5 KNUCKLE ENERGY TRANSFER HINGES- ETH

MODIFICATION ONLY	2W	4W	6W	8W	10W	12W	2WH	4WH	6WH	8WH	10WH	12WH
5 KNUCKLE - SW STEEL OR BRASS	\$106	\$106	\$124	\$140	\$160	\$170	\$152	\$169	\$186	\$203	\$220	\$230
5 KNUCKLE - SW STAINLESS STEEL	\$144	\$144	\$161	\$178	\$195	\$205	\$186	\$203	\$220	\$237	\$254	\$264
5 KNUCKLE - HW STEEL OR BRASS	\$119	\$119	\$135	\$152	\$169	\$179	\$161	\$178	\$195	\$212	\$229	\$239
5 KNUCKLE - HW STAINLESS STEEL	\$154	\$154	\$171	\$188	\$205	\$215	\$197	\$214	\$231	\$248	\$265	\$275



POWER TRANSFER HINGES

3 KNUCKLE STANDARD TRANSFER HINGES - ETH

STEEL BASE (CB70)	2W	4W	6W	8W	10W	12W	2WH	4WH	6WH	8WH	10WH	12WH
4.5 x 4.0	\$135	\$135	\$152	\$169	\$186	\$186	\$178	\$195	\$195	\$212	\$229	\$246
4.5 x 4.5	\$135	\$135	\$152	\$169	\$186	\$186	\$178	\$195	\$195	\$212	\$229	\$246
5.0 x 4.5	\$152	\$152	\$169	\$186	\$203	\$203	\$195	\$212	\$212	\$229	\$246	\$263
5.0 x 5.0	\$169	\$169	\$186	\$203	\$220	\$220	\$212	\$229	\$229	\$246	\$262	\$279
BRASS BASE (CB80)	2W	4W	6W	8W	10W	12W	2WH	4WH	6WH	8WH	10WH	12WH
4.5 x 4.0	\$161	\$161	\$178	\$195	\$212	\$212	\$203	\$220	\$222	\$237	\$254	\$271
4.5 x 4.5	\$161	\$161	\$178	\$195	\$212	\$212	\$203	\$220	\$222	\$237	\$254	\$271
5.0 x 4.5	\$178	\$178	\$195	\$212	\$231	\$231	\$220	\$237	\$239	\$254	\$273	\$290
5.0 x 5.0	\$190	\$190	\$207	\$224	\$243	\$243	\$233	\$250	\$252	\$267	\$286	\$303
STAINLESS STEEL BASE (CB80)	2W	4W	6W	8W	10W	12W	2WH	4WH	6WH	8WH	10WH	12WH
4.5 x 4.0	\$178	\$178	\$195	\$212	\$229	\$229	\$220	\$237	\$239	\$250	\$265	\$282
4.5 x 4.5	\$178	\$178	\$195	\$212	\$229	\$229	\$220	\$237	\$239	\$250	\$265	\$282
5.0 x 4.5	\$195	\$195	\$212	\$229	\$248	\$248	\$237	\$254	\$256	\$265	\$284	\$301
5.0 x 5.0	\$207	\$207	\$229	\$246	\$262	\$262	\$250	\$271	\$273	\$284	\$303	\$320

3 KNUCKLE HEAVY TRANSFER HINGES - ETH

STEEL BASE (CB75)	2W	4W	6W	8W	10W	12W	2WH	4WH	6WH	8WH	10WH	12WH
4.5 x 4.0	\$161	\$161	\$180	\$199	\$212	\$212	\$203	\$222	\$224	\$241	\$254	\$271
4.5 x 4.5	\$161	\$161	\$180	\$199	\$212	\$212	\$203	\$222	\$224	\$241	\$254	\$271
5.0 x 4.5	\$178	\$178	\$197	\$216	\$229	\$229	\$220	\$239	\$241	\$258	\$271	\$288
5.0 x 5.0	\$199	\$199	\$218	\$237	\$237	\$237	\$241	\$260	\$262	\$279	\$292	\$309
BRASS BASE (CB85)	2W	4W	6W	8W	10W	12W	2WH	4WH	6WH	8WH	10WH	12WH
4.5 x 4.0	\$174	\$174	\$190	\$207	\$224	\$224	\$216	\$233	\$235	\$250	\$267	\$284
4.5 x 4.5	\$174	\$174	\$190	\$207	\$224	\$224	\$216	\$233	\$235	\$250	\$267	\$284
5.0 x 4.5	\$190	\$190	\$207	\$224	\$241	\$241	\$233	\$250	\$252	\$267	\$284	\$301
5.0 x 5.0	\$212	\$212	\$229	\$246	\$262	\$262	\$254	\$271	\$273	\$288	\$305	\$322
STAINLESS STEEL BASE (CB85)	2W	4W	6W	8W	10W	12W	2WH	4WH	6WH	8WH	10WH	12WH
4.5 x 4.0	\$190	\$207	\$209	\$231	\$248	\$248	\$233	\$250	\$252	\$273	\$290	\$307
4.5 x 4.5	\$190	\$207	\$209	\$231	\$248	\$248	\$233	\$250	\$252	\$273	\$290	\$307
5.0 x 4.5	\$207	\$224	\$226	\$248	\$265	\$265	\$250	\$267	\$269	\$290	\$307	\$324
5.0 x 5.0	229	\$246	\$248	\$269	\$286	\$286	\$271	\$288	\$283	\$311	\$328	\$345

3 KNUCKLE ENERGY TRANSFER HINGES- ETH

MODIFICATION ONLY	2W	4W	6W	8W	10W	12W	2WH	4WH	6WH	8WH	10WH	12WH
3 KNUCKLE - SW STEEL OR BRASS	\$110	\$110	\$127	\$144	\$161	\$171	\$152	\$169	\$186	\$203	\$220	\$230
3 KNUCKLE - SW STAINLESS STEEL	\$152	\$152	\$169	\$186	\$203	\$213	\$195	\$212	\$229	\$246	\$261	\$271
3 KNUCKLE - HW STEEL OR BRASS	\$125	\$135	\$152	\$169	\$186	\$196	\$178	\$195	\$212	\$229	\$246	\$256
3 KNUCKLE - HW STAINLESS STEEL	\$163	\$163	\$180	\$197	\$214	\$224	\$205	\$222	\$239	\$256	\$273	\$283



5 KNUCKLE STANDARD TRANSFER HINGES - ETM

STEEL BASE (BB79)	M	2W	4W	6W	8W	10W	2WH	4WH	6WH	8WH
4.5 x 4.0	\$127	\$212	\$212	\$231	\$248	\$258	\$254	\$292	\$309	\$326
4.5 x 4.5	\$127	\$212	\$212	\$231	\$248	\$258	\$254	\$292	\$309	\$326
5.0 x 4.5	\$144	\$229	\$229	\$248	\$265	\$275	\$271	\$309	\$326	\$343
5.0 x 5.0	\$165	\$250	\$250	\$269	\$286	\$296	\$292	\$330	\$347	\$364
BRASS BASE (BB91)	M	2W	4W	6W	8W	10W	2WH	4WH	6WH	8WH
4.5 x 4.0	\$152	\$239	\$239	\$254	\$271	\$288	\$281	\$315	\$332	\$349
4.5 x 4.5	\$152	\$239	\$239	\$254	\$271	\$288	\$281	\$315	\$332	\$349
5.0 x 4.5	\$169	\$256	\$256	\$271	\$288	\$305	\$298	\$332	\$349	\$366
5.0 x 5.0	\$190	\$277	\$277	\$292	\$309	\$326	\$320	\$353	\$370	\$387
STAINLESS STEEL BASE (BB91)	M	2W	4W	6W	8W	10W	2WH	4WH	6WH	8WH
4.5 x 4.0	\$169	\$254	\$254	\$271	\$288	\$305	\$296	\$332	\$349	\$366
4.5 x 4.5	\$169	\$254	\$254	\$271	\$288	\$305	\$296	\$332	\$349	\$366
5.0 x 4.5	\$186	\$271	\$271	\$288	\$305	\$322	\$313	\$349	\$366	\$383
5.0 x 5.0	\$207	\$292	\$292	\$309	\$326	\$343	\$334	\$370	\$387	\$404

5 KNUCKLE HEAVY TRANSFER HINGES - ETM

STEEL BASE (BB68)	M	2W	4W	6W	8W	10W	2WH	4WH	6WH	8WH
4.5 x 4.0	\$161	\$246	\$246	\$262	\$279	\$289	\$298	\$298	\$332	\$349
4.5 x 4.5	\$161	\$246	\$246	\$262	\$279	\$289	\$298	\$298	\$332	\$349
5.0 x 4.5	\$178	\$262	\$262	\$279	\$296	\$306	\$315	\$315	\$349	\$366
5.0 x 5.0	\$199	\$284	\$284	\$301	\$317	\$327	\$337	\$337	\$370	\$387
BRASS BASE (BB99)	M	2W	4W	6W	8W	10W	2WH	4WH	6WH	8WH
4.5 x 4.0	\$180	\$262	\$262	\$279	\$296	\$313	\$305	\$341	\$358	\$375
4.5 x 4.5	\$180	\$262	\$262	\$279	\$296	\$313	\$305	\$341	\$358	\$375
5.0 x 4.5	\$197	\$279	\$279	\$296	\$313	\$330	\$322	\$358	\$375	\$392
5.0 x 5.0	\$218	\$301	\$301	\$313	\$334	\$351	\$343	\$379	\$396	\$413
STAINLESS STEEL BASE (BB99)	M	2W	4W	6W	8W	10W	2WH	4WH	6WH	8WH
4.5 x 4.0	\$197	\$279	\$279	\$296	\$313	\$330	\$322	\$358	\$375	\$392
4.5 x 4.5	\$197	\$279	\$279	\$296	\$313	\$330	\$322	\$358	\$376	\$392
5.0 x 4.5	\$224	\$309	\$309	\$326	\$343	\$360	\$351	\$387	\$404	\$421
5.0 x 5.0	\$239	\$322	\$322	\$339	\$356	\$372	\$364	\$400	\$417	\$434

5 KNUCKLE ENERGY TRANSFER HINGES- ETM

MODIFICATION ONLY	M	2W	4W	6W	8W	10W	2WH	4WH	6WH	8WH
5 KNUCKLE - SW STEEL OR BRASS	\$110	\$197	\$197	\$212	\$231	\$248	\$239	\$254	\$273	\$290
5 KNUCKLE - SW STAINLESS STEEL	\$144	\$231	\$231	\$248	\$262	\$279	\$273	\$290	\$305	\$322
5 KNUCKLE - HW STEEL OR BRASS	\$119	\$203	\$203	\$222	\$239	\$254	\$246	\$265	\$281	\$296
5 KNUCKLE - HW STAINLESS STEEL	\$152	\$239	\$239	\$254	\$271	\$288	\$281	\$296	\$313	\$330



POWER TRANSFERS HINGES

3 KNUCKLE STANDARD TRANSFER HINGES - ETM

STEEL BASE (CB70)	M	2W	4W	6W	8W	10W	2WH	4WH	6WH	8WH
4.5 x 4.0	\$135	\$222	\$222	\$239	\$254	\$271	\$265	\$301	\$315	-
4.5 x 4.5	\$135	\$222	\$222	\$239	\$254	\$271	\$265	\$301	\$315	-
5.0 x 4.5	\$152	\$239	\$239	\$256	\$271	\$288	\$281	\$317	\$332	-
5.0 x 5.0	\$174	\$260	\$260	\$277	\$292	\$309	\$303	\$339	\$353	-
BRASS BASE (CB80)	M	2W	4W	6W	8W	10W	2WH	4WH	6WH	8WH
4.5 x 4.0	\$152	\$239	\$239	\$254	\$271	\$288	\$281	\$315	\$332	\$349
4.5 x 4.5	\$152	\$239	\$239	\$254	\$271	\$288	\$281	\$315	\$332	\$349
5.0 x 4.5	\$169	\$256	\$256	\$271	\$288	\$305	\$298	\$332	\$349	\$366
5.0 x 5.0	\$190	\$277	\$277	\$292	\$309	\$326	\$320	\$353	\$370	\$366
STAINLESS STEEL BASE (CB80)	M	2W	4W	6W	8W	10W	2WH	4WH	6WH	8WH
4.5 x 4.0	\$174	\$258	\$258	\$275	\$292	\$309	\$301	\$337	\$353	\$370
4.5 x 4.5	\$174	\$258	\$258	\$275	\$292	\$309	\$301	\$337	\$353	\$370
5.0 x 4.5	\$190	\$275	\$275	\$292	\$309	\$326	\$317	\$353	\$370	\$387
5.0 x 5.0	\$212	\$296	\$296	\$313	\$330	\$347	\$339	\$375	\$392	\$408

3 KNUCKLE HEAVY TRANSFER HINGES - ETM

STEEL BASE (CB75)	M	2W	4W	6W	8W	10W	2WH	4WH	6WH	8WH
4.5 x 4.0	\$161	\$248	\$248	\$262	\$279	\$296	\$290	\$324	\$341	-
4.5 x 4.5	\$161	\$248	\$248	\$262	\$279	\$296	\$290	\$324	\$341	-
5.0 x 4.5	\$178	\$265	\$265	\$279	\$296	\$313	\$307	\$341	\$358	-
5.0 x 5.0	\$199	\$286	\$286	\$301	\$317	\$333	\$328	\$362	\$379	-
BRASS BASE (CB85)	M	2W	4W	6W	8W	10W	2WH	4WH	6WH	8WH
4.5 x 4.0	\$180	\$262	\$262	\$279	\$296	\$313	\$305	\$341	\$358	\$375
4.5 x 4.5	\$180	\$262	\$262	\$279	\$296	\$313	\$305	\$341	\$358	\$375
5.0 x 4.5	\$197	\$279	\$279	\$296	\$313	\$330	\$322	\$358	\$375	\$392
5.0 x 5.0	\$218	\$301	\$301	\$317	\$334	\$351	\$343	\$379	\$396	\$413
STAINLESS STEEL BASE (CB85)	M	2W	4W	6W	8W	10W	2WH	4WH	6WH	8WH
4.5 x 4.0	\$203	\$288	\$288	\$305	\$328	\$345	\$330	\$358	\$381	\$398
4.5 x 4.5	\$203	\$288	\$288	\$305	\$328	\$345	\$330	\$358	\$381	\$398
5.0 x 4.5	\$220	\$305	\$305	\$322	\$345	\$362	\$347	\$375	\$398	\$415
5.0 x 5.0	\$241	\$326	\$326	\$343	\$366	\$383	\$368	\$396	\$419	\$436

3 KNUCKLE ENERGY TRANSFER HINGES- ETM

MODIFICATION ONLY	M	2W	4W	6W	8W	10W	2WH	4WH	6WH	8WH
3 KNUCKLE - SW STEEL OR BRASS	\$119	\$203	\$203	\$220	\$237	\$254	\$246	\$262	\$279	\$296
3 KNUCKLE - SW STAINLESS STEEL	\$169	\$254	\$254	\$271	\$288	\$305	\$296	\$313	\$330	\$347
3 KNUCKLE - HW STEEL OR BRASS	\$135	\$222	\$222	\$239	\$256	\$273	\$265	\$281	\$298	\$315
3 KNUCKLE - HW STAINLESS STEEL	\$186	\$271	\$271	\$288	\$305	\$322	\$313	\$341	\$358	\$375

COMMAND ACCESS ENERGY TRANSFER SWINGCLEAR

ETH2W (2/20GA)	ETH4W (4/26GA)	ETH6W (6/26GA)	ETH8W (8/26GA)	ETH10W (10/28GA)	ETH2WH (2/18GA)	ETH4WH (2/18GA + 2/26GA)	ETH6WH (2/18GA + 4/26GA)	ETH8WH (2/20GA + 6/28GA)
----------------	----------------	----------------	----------------	------------------	-----------------	--------------------------	--------------------------	--------------------------

Specify Bevelled or Square. 626 Finish. Consult factory for other finishes.

5SW STEEL BASED SC	\$347	\$347	\$366	\$381	\$398	\$389	\$408	\$423	\$440
5HW STEEL BASED SC	\$389	\$389	\$408	\$423	\$440	\$432	\$451	\$466	\$483

ENERGY TRANSFER SPECIALTY- MOD

HINGE TYPE	2W	4W	6W	8W	10W	2WH	4WH	6WH	8WH
SWINGCLEAR - SW STEEL HINGE	\$254	\$254	\$271	\$288	\$305	\$296	\$313	\$330	\$347
SWINGCLEAR - HW STEEL HINGE	\$279	\$279	\$296	\$313	\$330	\$322	\$339	\$356	\$372
SWINGCLEAR - SW SS HINGE	\$288	\$288	\$305	\$322	\$339	\$330	\$347	\$364	\$381
SWINGCLEAR - HW SS HINGE	\$313	\$313	\$330	\$347	\$364	\$356	\$372	\$389	\$406
RAISED BARREL - SW STEEL HINGE	\$254	\$254	\$271	\$288	\$305	\$296	\$313	\$330	\$347
RAISED BARREL - HW STEEL HINGE	\$279	\$279	\$296	\$313	\$330	\$322	\$339	\$356	\$372
RAISED BARREL - SW SS HINGE	\$288	\$288	\$305	\$322	\$339	\$330	\$347	\$364	\$381
RAISED BARREL - HW SS HINGE	\$313	\$313	\$330	\$347	\$364	\$356	\$372	\$389	\$406
HALF OR FULL SURFACE - SW STEEL	\$265	\$265	\$281	\$298	\$315	\$307	\$324	\$341	\$358
HALF OR FULL SURFACE - HW STEEL	\$281	\$281	\$298	\$315	\$332	\$324	\$341	\$358	\$375
HALF OR FULL SURFACE - SW SS	\$296	\$296	\$313	\$330	\$347	\$339	\$356	\$372	\$389
HALF OR FULL SURFACE - HW SS	\$317	\$317	\$334	\$351	\$368	\$360	\$377	\$394	\$411

NOTE: Wire access hole location on all hinges, regardless of hinge manufacturer, are located per Command Access Templates unless otherwise requested. Our standard templates are available on our website at www.commandaccess.com.

ADDITIONAL OPTIONS FOR POWER TRANSFER

DOOR 4' LEAD	Standard 4' Lead on Door Side - Included Standard with every hinge	n/c
FRAME 4' LEAD	Add 4' Lead on Frame Side	CALL
WT	Additional charge to supply a wide throw hinge	\$42
QC	8-pin or 12-pin Molex Connector added to hinge	\$46
QC w/ LEAD	8-pin or 12-pin Molex Connector added to hinge	\$74
DOOR CORD QC	8-pin or 12-pin Molex Connector added to hinge	\$85
HT	Add Hospital Tip to Hinge (SS/Brass Only)	\$85
CAT HINGE REWIRE	Rewire Command Access Hinge	\$85
OTHER HINGE REWIRE	Rewire another manufacturers hinge	\$106

Allegion Connect® is a registered trademark of Allegion

ElectroLynx® is a registered trademark of Assa Abloy

Micro-Fit 3.0™ Interconnect System available to retrofit common quick connection systems such as ElectroLynx® or Allegion Connect®.

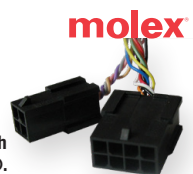



POWER TRANSFERS

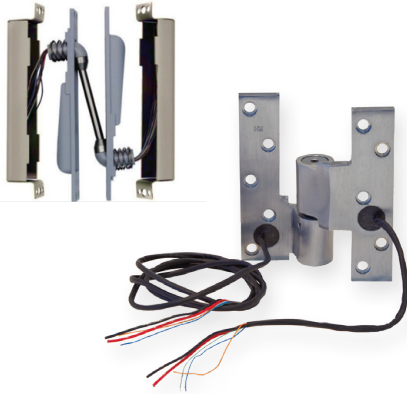

▬ = Not Applicable ✓ = Available

COMMAND ACCESS ENERGY TRANSFER PIVOTS

- CAT PIVOT = EQUAL TO RIXON EM19
- CAT EPT = EQUAL TO VON DUPRIN EPT
- 4' LEAD AVAILABLE AT NO EXTRA CHARGE
- MULTIPLE WIRE CONFIGURATIONS
- 3-YEAR "NO HASSLE" WARRANTY

WIRE MORTISE/CYLINDRICAL LOCK, & EXIT TRIM						WIRE HEAVY LATCH RETRACTION				
2W (2/20GA)	4W (4/26GA)	6W (6/26GA)	8W (8/28GA)	10W (10/28GA)	12W (12/28GA)	2WH (2/18GA)	4WH (2/18GA + 2/26GA)	6WH (2/18GA + 4/28GA)	8WH (2/20GA + 6/28GA)	10WH (2/20GA + 8/28GA)

Specify Handing, Finishes available in 613, 625, 626.

NOTE: Wire access hole location on all hinges, regardless of hinge manufacturer, are located per Command Access Templates unless otherwise requested. Our standard templates are available on our website at www.commandaccess.com.

INTERMEDIATE PIVOT - CAT PIVOT	\$305	\$305	\$322	\$339	\$356	\$366	\$347	\$364	\$381	\$398	\$415
--------------------------------	-------	-------	-------	-------	-------	-------	-------	-------	-------	-------	-------

ENERGY TRANSFER PIVOTS - MOD

3/4" OFFSET BRASS OR ALUMINUM	\$288	\$288	\$305	\$322	\$339	\$349	\$330	\$347	\$364	\$381	\$398
3/4" OFFSET STAINLESS STEEL	\$313	\$313	\$330	\$347	\$364	\$374	\$356	\$372	\$389	\$406	\$423
1-1/2" OFFSET BRASS OR ALUMINUM	\$296	\$296	\$313	\$330	\$347	\$357	\$339	\$356	\$372	\$389	\$406
1-1/2" OFFSET STAINLESS STEEL	\$322	\$322	\$339	\$356	\$372	\$382	\$364	\$381	\$398	\$415	\$432
TOP, POCKET, OR CENTER HUNG PIVOT	\$169	\$169	\$186	\$203	\$220	\$230	\$212	\$229	\$246	\$262	\$279

CONCEALED EPT

CAT EPT ALUM	Concealed Power Transfer ALUM specify (2 Wire or 10 Wire), same prep as Von Duprin EPT	\$400
CAT EPT DURO	Concealed Power Transfer DURO specify (2 Wire or 10 Wire), same prep as Von Duprin EPT	\$400

ADDITIONAL OPTIONS FOR POWER TRANSFER

DOOR 4' LEAD	Standard 4' Lead on Door Side - Included Standard with every hinge	n/c
FRAME 4' LEAD	Add 4' Lead on Frame Side	CALL
WT	Additional charge to supply a wide throw hinge	\$42
QC	8-pin or 12-pin Molex Connector added to hinge	\$46
QC w/ LEAD	8-pin or 12-pin Molex Connector added to hinge	\$74
DOOR CORD QC	8-pin or 12-pin Molex Connector added to hinge	\$85
HT	Add Hospital Tip to Hinge (SS/Brass Only)	\$85
CAT HINGE REWIRE	Rewire Command Access Hinge	\$85
OTHER HINGE REWIRE	Rewire another manufacturers hinge	\$106

Micro-Fit 3.0™ Interconnect System available to retrofit common quick connection systems such as ElectroLynx® or Allegion Connect®.

Command Access is not a licensee or affiliated, associated or connected with Allegion, Assa Abloy, Dorma, Stanley Security, Adams Rite, Arrow, Corbin Russwin, McKinney, Pemko, Rixson, Sargent, Yale, Dor-O-matic, Falcon, Ives, Monarch, Schlage, Von Duprin, Best, Precision, Accurate, AHT, Baldwin, Bommer, Cal Royal, CR Laurence, Design Hardware, Emtek, First Choice, FSB, General Lock, Hager, Jackson, Keedex, Lawrence, LSDA, Marks, Marshal-Best, Molex, Omnia, PBB, PDQ, or any of their subsidiaries or affiliates.



CONCEALED DOOR LOOPS

ALWAYS HERE TO HELP

- DURABLE FINISH
- SPECIAL 1/4" FLEXIBLE ARMoured CONDUIT (I.D. 1/4")
- SUPPORTS UP TO 180° SWING (STANDARD BUTT AND CONTINUOUS HINGE APPLICATIONS)
- SUPPORTS UP TO 105° SWING ON 3/4 OFFSET PIVOTS
- EASY INSTALLATION
- VARIABLE MOUNTING LOCATIONS
- FITS UP TO 2-12GA WIRES

FOR CONTINUOUS AND BUTT HINGE APPLICATIONS

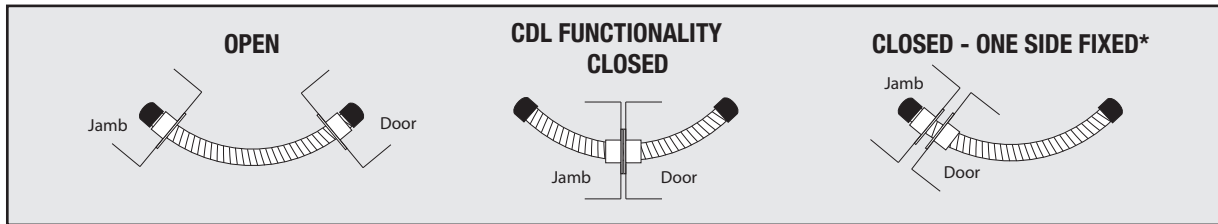

CDL-AL	Aluminum Finish, 6" total length.	\$45
CDL-BLK	Black Finish, 6" total length.	\$45
CDL-AL-FX	Aluminum Finish, 6" total length. Includes 1 side fixed for complete concealment in opposite side.	\$50
CDL-BLK-FX	Black Finish, 6" total length. Includes 1 side fixed for complete concealment in opposite side.	\$50



FOR 3/4" OFFSET PIVOT APPLICATIONS

CDL-AL-EXT	Aluminum Finish, 12" total length. Includes 1 side fixed for complete concealment in opposite side & extended length for wire guidance	\$60
CDL-BLK-EXT	Aluminum Finish, 12" total length. Includes 1 side fixed for complete concealment in opposite side & extended length for wire guidance	\$60
CDL-AL-EXT2	Aluminum Finish, 18" total length. Includes 1 side fixed for complete concealment in opposite side & extended length for wire guidance	\$76
CDL-BLK-EXT2	Aluminum Finish, 18" total length. Includes 1 side fixed for complete concealment in opposite side & extended length for wire guidance	\$76

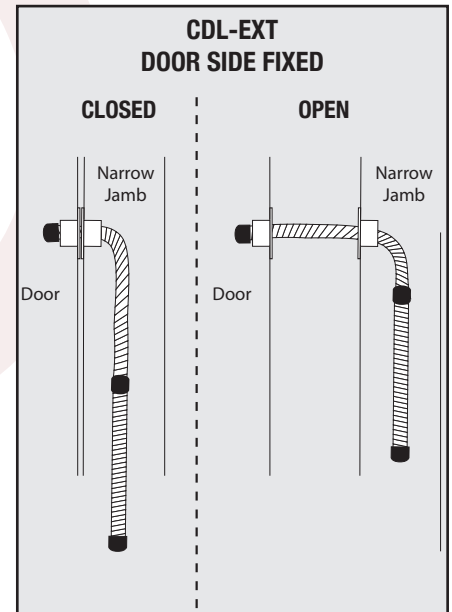

DOOR LOOPS

The door loop is a low cost method of transferring low voltage power from the door frame to the locking device.

DL-22A	22" Door Loop, Aluminum Finish (Can be cut in the field to length)	\$42
DL-22D	22" Door Loop, Aluminum Finish (Can be cut in the field to length)	\$42
NDL-18A	Narrow 18" Door Loop, Aluminum Finish (Can be cut in the field to length)	\$38
NDL-18D	Narrow 18" Door Loop, Aluminum Finish (Can be cut in the field to length)	\$38





C.A.T INSTALLATION TOOLS

CAT-HIIT-21	MORTISE LOCK CYLINDER GUIDE	CALL
CAT-HIIT-22	MORTISE LOCK DOUBLE CYLINDER GUIDE	CALL
CAT-HIIT-50	CYLINDRICAL LOCK BORE HOLES	CALL
CAT-HIIT-111	GRADE 1 CYLINDRICAL LOCK FACE HOLES	CALL
CAT-HIIT-66- CLAMP	CLAMP SYSTEM FOR ALL HIT-66 GUIDES	CALL
CAT-HIIT-66-110	CYLINDRICAL LOCKS	CALL
CAT-HIIT-66-230	BEST 35 & 45 SERIES MORTISE LOCKS	CALL
CAT-HIIT-66-235	CORBIN RUSSWIN 2200 SERIES MORTISE LOCK	CALL
CAT-HIIT-66-240	FALCON MA SERIES MORTISE LOCK	CALL
CAT-HIIT-66-280	SARGENT 8000 SERIES MORTISE LOCK	CALL
CAT-HIIT-66-282	SCHLAGE L SERIES MORTISE LOCK	CALL
CAT-HIT-32VD9W	VON DUPRIN 98/99 WOOD RIM & SVR	CALL
CAT-DT-200	CYLINDRICAL LOCK BORE HOLES	CALL
CAT-DT-100	CYLINDRICAL LOCK BORE HOLES	CALL
DOOR DOLLY 1	MINI DOOR DOLLY	CALL
DOOR DOLLY 2	DOOR DOLLY	CALL
5SW-TEMP	5K STANDARD WEIGHT TEMPLATE FOR WIRE ACCESS HOLES, SPECIFY SIZE	\$20
5HW-TEMP	5K HEAVY WEIGHT TEMPLATE FOR WIRE ACCESS HOLES, SPECIFY SIZE	\$20
3SW-TEMP	3K STANDARD WEIGHT TEMPLATE FOR WIRE ACCESS HOLES, SPECIFY SIZE	\$20
3HW-TEMP	3K HEAVY WEIGHT TEMPLATE FOR WIRE ACCESS HOLES, SPECIFY SIZE	\$20

1. Free with hinge orders of 10+



QR code you can scan with your smartphone or on the electronic version click as a hyperlink.

TERMS AND CONDITIONS



PRICES: All list prices are subject to change without prior notice and are not guaranteed. All prices are per unit (each) unless otherwise specified and do not include sales or local taxes. All shipments will be made at prices prevailing at time of shipment.

EXPEDITE FEE: A customer may request that an order be expedited. An additional charge of up to 25% of the cost of the expedited items may be charged. Expedite lead times are subject to availability. Please call for approval.

PAYMENT TERMS: The standard credit terms of Command Access Technologies (herein called CAT) are 2% 10 days net 30. Net 30 means the check shall be received at CAT on or before 30 days from the date of the invoice. Interest will be charged at the rate of 2% per month on past due accounts.

ACCEPTANCE OF ORDERS AND/OR QUOTATIONS: Possession of prices from CAT does not commit CAT to accept any order. CAT reserves the right to refuse any order and will not be bound to fulfill any order until it has been accepted by a representative of CAT and confirmed by a written acknowledgement. Quotations are valid for ninety (90) days following the date of the quotation.

OPEN ACCOUNT STATUS: CAT reserves the right to decline or discontinue direct sales to any customer who does not meet an annual minimum sales requirement of 5000.00 in invoiced purchases.

ACKNOWLEDGEMENTS: An acknowledgement is an exact copy of a customer's order as entered by CAT and should be verified by the customer. If the acknowledgement does not agree with said customer's understanding CAT should be advised within (3) three days or the order will be billed as acknowledged. CAT's sales terms shall apply irrespective of any special stipulation appearing in customer order, unless specifically acknowledged and accepted by CAT.

RETURNED GOODS: The customer must advise customer service at CAT of merchandise to be returned and a Returned Goods Authorization (RGA) will be issued. CAT will not accept goods returned without an RGA. Full credit against further purchases or a replacement will be made at the option of CAT if upon investigation reveals that goods were shipped in error or if goods are defective in workmanship or material. Otherwise, a restocking fee of not less than (25) twenty-five percent will be charged. All merchandise must be PREPAID AND PROPERLY PACKED. All C.O.D. orders shipped to CAT will be refused. Returned goods must be packed in their original boxes. If product has been installed it cannot be returned but only repaired, please consult factory for repair costs (unless under warranty). No credit will be given for product not in its original form unless, upon CAT's inspection, product is found to be defective. If product is returned as defective and is found to be operational, product will be returned to customer (C.O.D.) and no credit will be issued.

MINIMUM CHARGE: No order will be invoiced for less than \$25.00 net plus shipping charges.

CHANGES OR CANCELLATIONS: When a special order is accepted, and entered, no change can be made and the order is non-cancellable. Cancellation for items already packed for shipment will be removed if possible. A twenty-five percent (25%) restocking fee will apply.

CLAIMS OR SHORTAGES: Every possible care is taken in the final examination of packing of goods, and no complaints will be accepted unless made promptly upon receipt of goods. No claim will be allowed for work done by others, consequential damages or other expenditure, and CAT's understanding to repair or replace defective goods is its only liability. No claim for damage shortage or loss in transit will be accepted unless notice is given in writing to the carrier and to CAT within (10) ten days of receipt of goods.

BACK CHARGES: CAT is not responsible for, does not authorize, and will not accept any charges for the cost of labor, travel or material incurred by anyone other than CAT for any installation, repair, service, or replacement unless incurred with CAT's prior written consent and agreement.

FREIGHT CHARGES: All goods are invoiced F.O.B. CAT, Yorba Linda, California. Freight charges are prepaid and are added to invoice. Consignee pays C.O.D. freight charges when delivered to the Freight Company the shipment becomes the property of the purchaser, who assumes the risk of loss or damage in transit. If invoice exceeds \$1,000.00 net, full service freight by FedEx or our choice within the continental U.S.A. (excluding Hawaii, Alaska, Guam & Puerto Rico) is deductible, provided invoice is paid within set terms. Not all products qualify for freight deduction. Airfreight and other special shipments are not deductible. CAT does not ship directly to Canada, for all Canadian destinations please contact Connection Network Agencies at 905-823-3002.

PRODUCT CHANGES OR CANCELLATIONS: CAT reserves the right to modify or discontinue any price, product, design, function and finish without prior notice.

PRODUCT FINISHES: Although CAT modifies products with the finest protective coatings, they do have their limitations. In time, they might deteriorate from extremes in climate, frequency of use, perspiration, or other factors. CAT does not consider excessive wear or tarnishing of the finish because of any of the above conditions as a defect. It is considered a normal process, which cannot be avoided. Thus, CAT cannot guarantee product finishes and will not repair or replace finishes under this warranty.



C.A.T
COMMITMENT

NO HASSLE
3 YEAR
WARRANTY

INNOVATIVE
SOLUTIONS



ALWAYS HERE TO HELP

Follow us and you'll never walk alone!



www.commandaccess.com
Live Chat Available
Customer Support 1-888-622-2302



SEPTEMBER, 2019
PL EFFECTIVE: AUGUST, 2019



NO HASSLE
3 YEAR
WARRANTY