

LCN®

1461 Series

Door controls

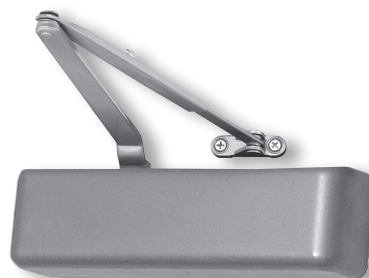

Fire Rated: Tested on fire door assemblies in accordance with Australian Standards, refer fire door manufacturer for specific approval details

The LCN 1461 Series is a non-handed surface mounted closer designed for maximum versatility. A wide choice of options, mounting accessories and ease of installation make this a fully universal closer.

The LCN 1461 Series has been designed to be used on aluminium, hollow metal or wood swinging commercial interior/exterior doors and is ideally suited for hospitals, nursing homes, hostels, shopping centres, commercial buildings, hotels, educational and institutional applications.

Features

- Universal, fully reversible, non-handed door closer
- Closer cylinder constructed of high strength cast iron for increased durability
- Tested to 2,000,000 cycles
- Fully adjustable 1-6 spring strength to suit door size and site conditions
- Factory set to strength 3
- Standard closer offers 3 installation options
 - Regular (pull side)
 - Top jamb (push side)
 - Parallel arm (push side)
- Independent adjustment valves for adjusting backcheck, closing and latching speeds
- All adjustment valves are concealed behind the cover to prevent tampering
- Joints in arms and shoe brackets adapt to uneven mounting surfaces
- Stick-on template for fast, accurate installation. Cuts installation time in half
- Closers installed according to LCN installation instructions require minimal periodic maintenance or adjustments
- Cush-N-Stop® function has a built in stop incorporated into the arm to prevent damage to the closer, door or frame in the event of an abrupt stop
- The 30 year warranty provides specifiers and users with assured quality and performance

Specification guide

Series	Function	Finish
LCN 1461 series LCN1461	Regular R Hold open HO Delayed action DA Cush-N-Stop® CNS Hold open Cush-N-Stop® CNS-HO	Aluminium ALUM

- Series
Select the desired series e.g. LCN 1461 series LCN1461
- Function
Select the required function LCN1461HO
- Finish
Select the desired finish e.g. Aluminium LCN1461HOALUM

Selection Chart

Strength	Exterior door	Interior door
1 - 2	NA	610mm - 864mm
3	610mm - 762mm	864mm - 965mm
4	762mm - 914mm	965mm - 1219mm
5	914mm - 1067mm	1219mm - 1372mm
6	1067mm - 1219mm	1372mm - 1524mm

Specifications

Door type	Timber or metal
Door size	External door 610mm - 1219mm Internal door 610mm - 1524mm
Applications	Regular - pull side mount Parallel arm - push side mount Top jamb - push side mount
Adjustment controls	Closing speed Latching speed Delayed action Backcheck
Strength	1-6 adjustable
Options	Hold open arm Cush-N-Stop® arm Hold open Cush-N-Stop® arm Adaptor plate Parallel arm drop plate Square metal cover
Finishes	Aluminium, satin stainless steel (optional cover only), polished stainless steel (optional cover only)
Warranty	30 year mechanical



Caution!

The LCN 1461 is designed for reduced opening force which when set to a 1 strength makes it suitable for use by people who are frail, aged or disabled. This closer can operate at between 14-20Nm from initial opening up to 90°

Where door closers are installed and adjusted to meet reduced opening force requirements, there may be insufficient power to reliably close and latch the door, depending on prevailing operating conditions

Note

In areas of high wind pressure and/or air conditioning pressures or doors located in exceptionally heavy traffic or oversized/heavy doors, the LCN 4041 series closers or LCN automatic door operators are recommended

Regulating controls

The LCN 1461 has independent regulators to control

Closing speed	Adjustment to increase or decrease the speed at which the door closes. This allows the appropriate momentum to close the door in a safe and secure manner. Closing speed adjustment operates from the maximum opening to 15°
Latching speed	The latching speed allows the door to close quietly and firmly. It can be adjusted to increase or decrease the speed at which the door finally closes. This assists the final stage of the closing cycle to help overcome stubborn latchbolts or air pressure conditions. The latching speed adjustment operates from 15° to closing
Backcheck	Adjustable hydraulic backcheck provides a cushioning effect when the door is forcibly thrown open to prevent damage to the closer, door and frame. The backcheck adjustment allows the level of resistance in the latter stage of opening to be set at the level required. Backcheck is effective from 75°. Backcheck is a requirement for all fire rated closers
Delayed action	Enables door closing action to be delayed for an adjustable period of time before resuming normal closing, allowing slow moving traffic to pass through. Delay action can be adjusted up to a delay time of approximately 1 minute. Operational zone of delay is between 180° to 75°
Power adjustment	Spring strength may be increased or decreased by turning the allen head screw located in the end of the door closer body

Functions

Regular	For applications where the door must fully close after each opening
Hold open	Suitable for doors where the door may need to be left in a hold open position. The hold open function can be set to hold open at a single point. Hold open closers can not be used on fire doors
Delayed action	Delayed action closers have an inbuilt adjustable control that delays the closing of the door, for up to approximately 1 minute
Cush-N-Stop®	Used predominantly on outward swinging doors in situations where it is not practical to fit a door stop. The Cush-N-Stop® function has a built in stop incorporated into the arm to prevent damage to the closer, door or frame in the event of an abrupt stop. It is recommended that metal door frames be reinforced where the arm attaches to the transom. Maximum door opening 100°
Hold open Cush-N-Stop®	Provides the same function as the Cush-N-Stop®, but has the added feature of a hold open function in the arm, which is engaged/disengaged by a tee handle. Maximum door opening 100°

Mounting details

Regular (pull side) mounting

Regular mounting has a maximum opening of 180° , with frame and trim permitting. The hold open arm allows the door to be set at one given hold open point up to the maximum opening. The reveal should not exceed 19mm for a regular arm or 13mm for a hold open arm. Top rail less than 64mm requires adaptor plate. Adaptor plate requires a 38mm minimum top rail. Clearance of 70mm behind door is required for 90° installation. Delayed action closer delays closing from 110° to 65° or 160° to 75° depending on templating

Maximum opening 110°

A = 169mm

B = 286mm

Maximum opening 180°

A = 76mm

B = 191mm

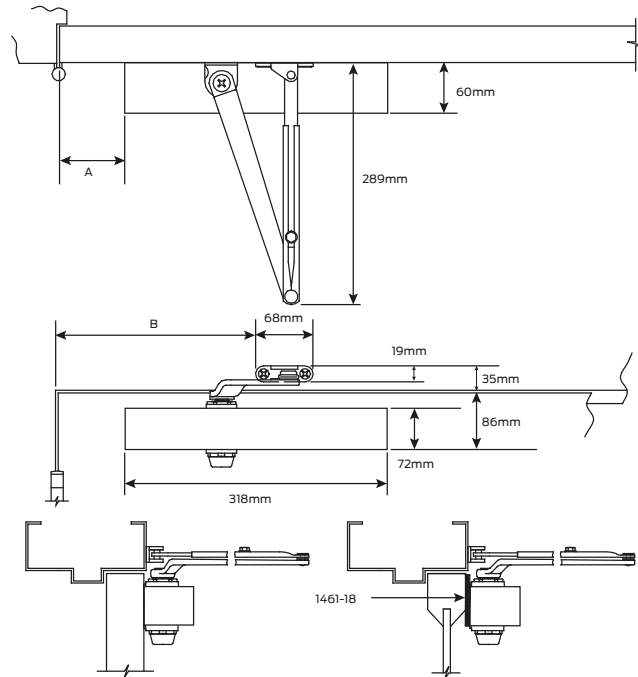

Top jamb (push side) mounting

Top jamb mounting has a maximum opening of 180° . The hold open arm allows the door to be set at a given hold open point up to the maximum opening. A reveal of 64mm for hold open arms and 89mm for regular arms allows a 180° opening. Top rail less than 48mm requires adaptor plate. Adaptor plate requires a 70mm minimum top rail. For situations where the head frame is less than 44mm or a flush ceiling condition exists with a 51mm head frame, an adaptor plate is required. Adaptor plate requires a 32mm minimum head frame. Delayed action closer delays closing from 110° to 75° or 180° to 95° depending on templating.

Maximum opening 110°

A = 169mm

B = 286mm

Maximum opening 180°

A = 76mm

B = 191mm

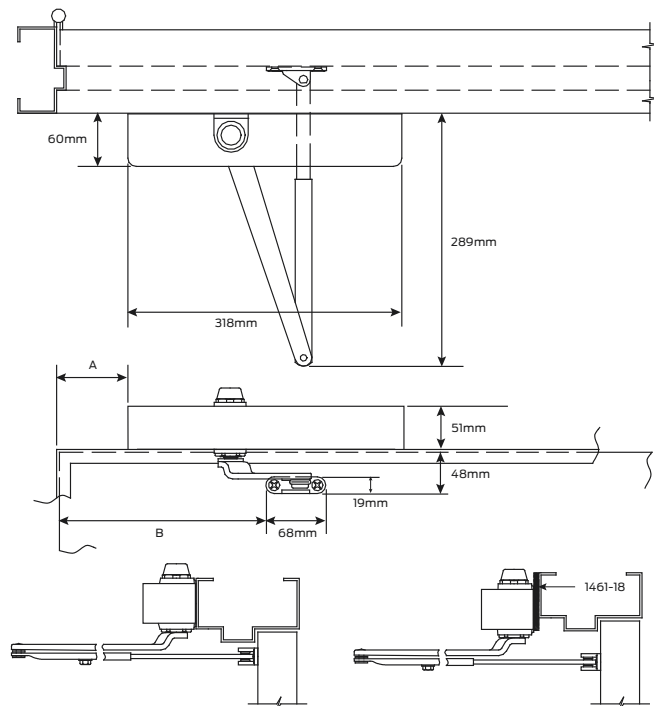

Mounting details

Parallel arm (push side) mounting

Parallel arm mounting has a maximum opening of 180°. The hold open arm allows the door to be set at one given hold open point up to the maximum opening. Clearance for the PA shoe is 102mm from door face. Top rail less than 108mm measured from the stop requires drop plate. The drop plate requires a 44mm minimum top rail. Minimum stop width is 25mm. Blade stop clearance requires 13mm blade stop spacer. Delayed action closer delays closing from maximum opening to approximately 75°. When installing closers in parallel arm configuration, strength may be needed to be adjusted upwards to compensate for power reduction

Maximum opening 100°

A = 108mm

B = 235mm

Maximum opening 180°

A = 44mm

B = 171mm

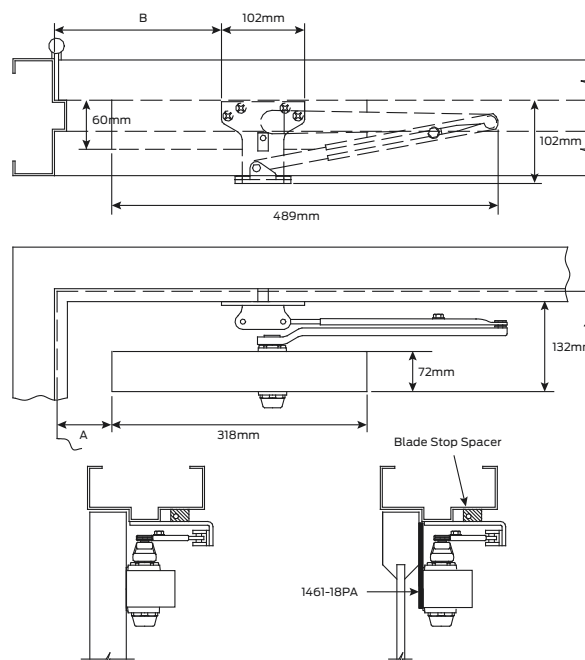

Cush-N-Stop® (push side) mounting

Cush arms can be templated for the following maximum opening/hold open points:

1. 85° - A = 60mm & B = 243mm
2. 90° - A = 41mm & B = 230mm
3. 100° - A = 16mm & B = 205mm

Clearance for the cush shoe is 140mm from door face. Top rail less than 108mm measured from the stop requires drop plate. The drop plate requires a 44mm minimum top rail

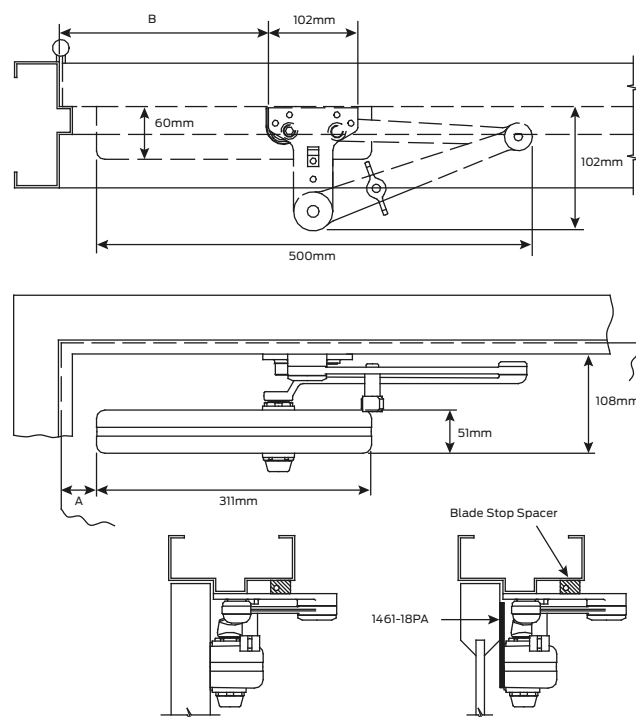

1461 Series accessories

Regular arm 1460-3077

Standard, non-handed arm mounts hinge side or top jamb. For parallel arm mounting, a PA shoe is also required
Finish: Aluminium

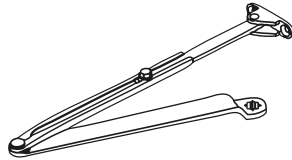

Hold open 1460-3049

Non-handed, hold open arm mounts hinge side or top jamb. For parallel arm mounting, a PA Shoe is also required. Hold open adjustable at shoe
Finish: Aluminium

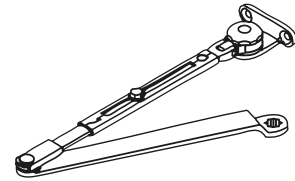

Cush-N-Stop[®] arm 1460-3077CNS

Non-handed parallel arm features solid forged steel main arm and forearm, with stop in soffit shoe
Finish: Aluminium

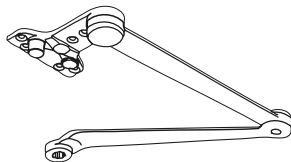

Hold open Cush-N-Stop[®] arm 1460-3049CNS

Non-handed arm, provides hold open function with templated stop/hold open points. Handle controls hold open function
Finish: Aluminium

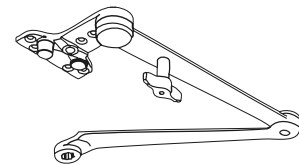

Metal cover 1460-MC

Non-handed cover, providing complete enclosure of closer body
Finishes: Polished stainless steel, satin stainless steel

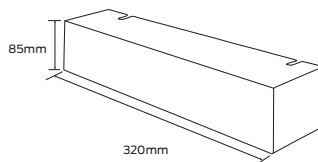

Blade stop spacer 1460-61

Lowers parallel arm shoe to clear 13mm blade stop

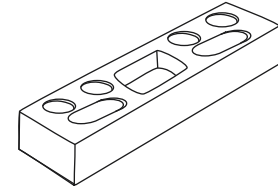

Drop plate 1460-18PAFC

Mounting plate required for parallel arm mounting configuration where top rail is less than 114mm, measured from the stop. A drop plate requires a 44mm minimum top rail

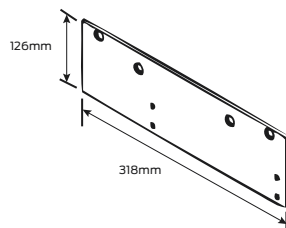

Adaptor plate 1460-18FC

Mounting plate required top jamb mounting where head frame is less than 60mm or a flush ceiling condition exists

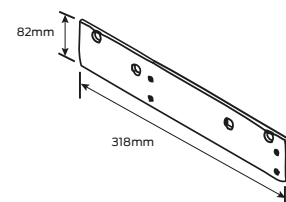

PA shoe 1460-62PA

Required for parallel arm mounting configurations
Finish: Aluminium

