

FALCON®

Cylinders, keys
and keying
systems

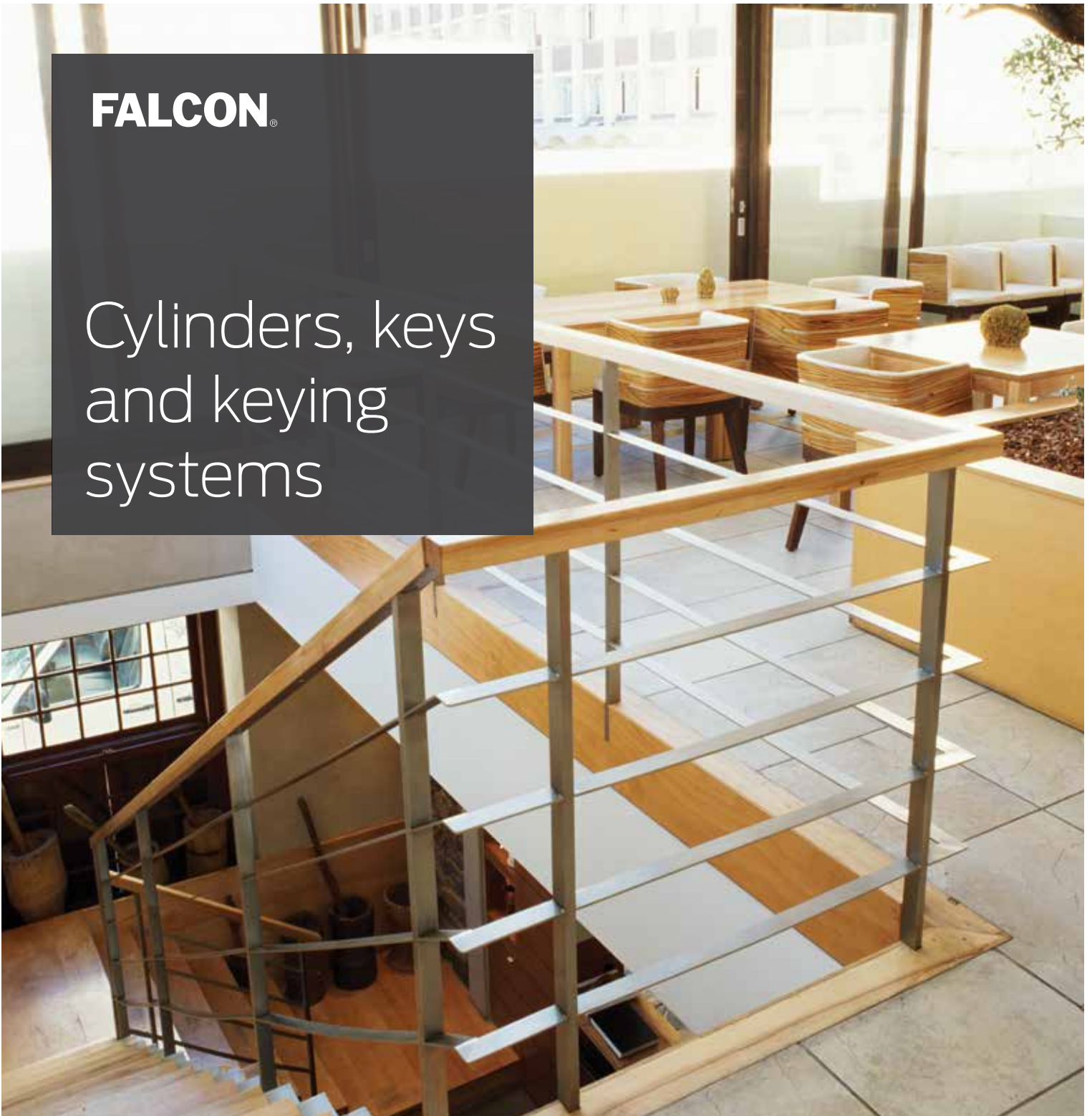

Contents

- 4 Key and cylinder marking
- 5-7 How to specify master keying
- 8 Keyways and construction keying
- 9 Standard cylinders - Conventional and auxiliary cylinders
- 10-12 Standard cylinders - Competitor keyways
- 13 Standard cylinders - Key blanks and keys
- 14-15 Standard cylinders - Tailpieces and accessories
- 16-17 Interchangeable core
- 18 Interchangeable core - Keys and keyblanks
- 19-20 Interchangeable core - Tailpieces, construction keying and accessories
- 21 Mortise cylinders - Mortise, rim and cam lock cylinders
- 22 Mortise cylinders - Mortise, rim and cam lock housing
- 23-24 Mortise cylinders - Cams
- 25-26 Mortise cylinders - Cylinder collars

The Falcon difference

Safety, security and uncompromising value

At Falcon, we know that every product you sell not only has to meet local building codes, but also your expectations for performance and quality. We take your expectations seriously, and that's why we build our locks to deliver durability, convenience and unmatched value. After all, we've built our reputation on the same standards that you have – providing quality products at a reasonable price delivered on time. It's the way we do business and it's what makes Falcon locks a powerful choice, no matter what your project.

Cylinders, keys and keying systems

Keys and key control are integral parts of maintaining building security, whether it's during construction or changes in occupancy or use. Falcon offers some of the most versatile and easy to use cylinders and keying systems in the industry. Our interchangeable cores can be removed for quick, easy re-keying and are compatible with SFIC products from other manufacturers. Our multi-level master key program ensures safe, accurate key control. And our full line of mortise cylinders ensures maximum durability, performance and security no matter what the application. Most important, every cylinder, key and keying system we make is backed by one of the best names in the business.

Keyways and construction keying

Keyways

“G” keyway is standard for all Falcon conventional (non-I/C) cylinders and will be supplied unless otherwise specified. The multiple keyway structure shown to the right is used to expand keying systems which require more than one keyway.

Falcon bored locksets are also available with the most common competitors’ keyways shown below. Falcon does not offer master keying of their keyways. D Series deadlocks are limited to “D1”, “L4”, “C”, “E” and “E1R” keyways.

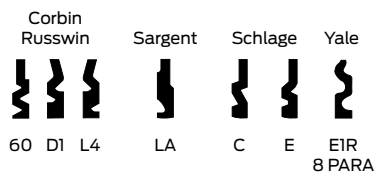

Falcon multiplex key family

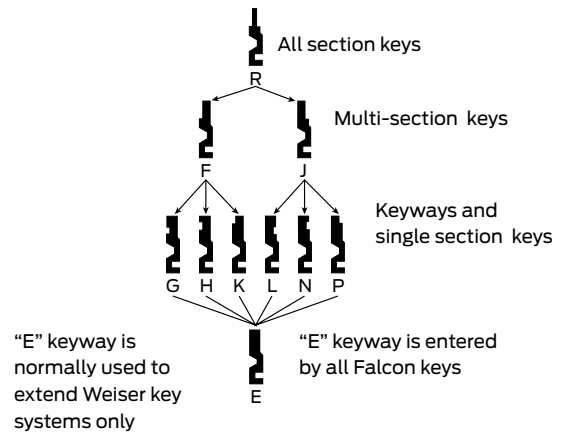

Construction master keying

Construction master keying is an option for conventional (non-I/C) cylinders and locksets. Cylinders are prepared with a special construction pin at the factory so that the construction master key (CMK) operates all cylinders while the building is under construction.

When construction is complete, turn the top master key in each cylinder. This process moves the special construction pin into a pocket of the cylinder plug, thereby eliminating subsequent operation of the CMK.

To order, specify “(CMK)” after the line item.
Example: 72 each D441 626 1AA - 72AA (CMK)

Blockokey® system

Falcon’s Blockokey® system is used for extensive master key systems using conventional (non-I/C) cylinders and locksets. Locks are shipped from the factory with a plastic “key block” in the back of every cylinder’s keyway. A shorter 4-pin “Project Key” operates all cylinders while the building is under construction.

When construction is complete, use the special KB536 extractor key (removal tool) to remove the key block from each cylinder, thereby voiding operation of the project key. Blockokey construction keying is available on select keyways. Consult the Falcon master key team for availability.

To order, specify “Blockokey” after the line item.
Example: 72 each D441 626 1AA - 72AA Blockokey

SKD security caution

Unless otherwise specified, SKD sets will not be construction master keyed. Doing so significantly limits the system’s expansion and decreases the security of the SKD locks.

When construction master keying is required for SKD sets, Falcon recommends issuing the SKDs on a different keyway with their own (separate) CMK. All orders which include SKD sets should specify how the construction keying should be handled.

Orders must include the name and address of the person to whom the construction keys and permanent master and change keys should be sent.

How to specify master keying

2- and 3-Level master keying systems

To specify a simple master key system (2 levels of keying)

The master key symbol consists of TWO letters, such as AA.
The change key numbers are added to the master key letters.
The numbers come first: 1AA, 2AA, 3AA, etc.

When locks are required which are not operated by the master key or other change keys in the system, they are referred to as “single keyed” and given symbols SKD1, SKD2, etc. When all higher levels of master keys are to be disallowed, suffix (NMK) to the symbol of the key which is to operate. This means “not master keyed.” Cylinder 1AA(NMK) is operated by 1AA only. The AA master is blocked from operation.

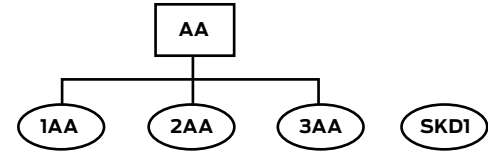

To specify a grand master key system (3 levels of keying)

The grand master is assigned any ONE letter, such as A. The master keys under this grand are assigned TWO letters, the first of which must be the same as the grand: AA, AB, AC, etc. are all masters under grand A. Masters BA, BB, BC, etc. are all under grand B. Caution: Do not use the letters I or O because of possible confusion with the numerals 1 and 0, respectively. Also, do not use master key symbols CK, KD or KA. Change key numbers come after the letters.

For master keys beyond AZ, insert a number between the letters to designate which pass through the alphabet they represent. A2A through A2Z represents the second pass of masters under grand A. A3A through A3Z would be the third. Change keys under these masters have the numbers suffixed in the usual way: A2A1, A2A50, etc.

If the cylinder is to be operated by its change key and nothing lower than the single lettered GMK, the change number is added to the GMK symbol. This is illustrated by the example A1 in the schematic shown. When locks are required which are not operated by ANY master keys or other change keys in the system, they are referred to as “single keyed” and given symbols SKD1, SKD2, etc.

When all higher levels of master keys are to be disallowed, suffix (NMK) to the symbol of the key which is to operate. This means “not master keyed” and can be applied to any level in the system. Cylinder AA1 (NMK) is operated by AA1 only. The AA master and A grand are blocked from operation. Cylinder AA (NMK) would be operated by the AA master only. Grand A does not operate.

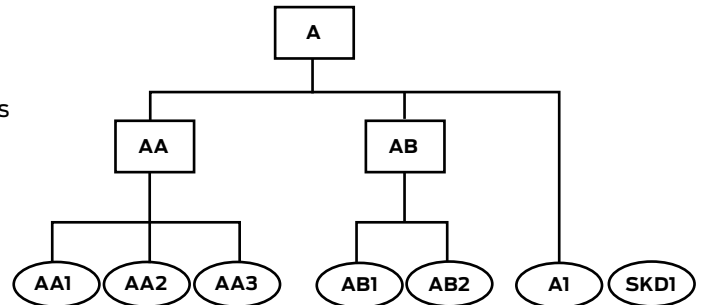

How to specify master keying

(continued)

4-Level master keying systems

To specify a great grand master key system (4 levels of keying)

The great grand master key is assigned the symbol GGM. The rest of the symbols are the same as those in 3-level systems. The GMKs are assigned single letters, e.g. A, B, C, D, etc. Caution: Never use X for a grand master key due to the confusion which will result with cross keying symbols presented on the next page.

Masters under each GMK are assigned two letters, the first of which is the same as its respective grand master key. Change key numbers come after the letters. Changes under the grand (A1, B1, etc.) and masters beyond AZ are handled exactly as in the 3 level system already described. Changes directly under a grand are also handled as illustrated in the 3-level system. For changes directly under the GGM with no

intermediate level masters, the change number is added directly to GGM as shown by the example GGM1 in the schematic. When locks are required which are not operated by ANY master keys or other change keys in the system, they are referred to as "single keyed" and given symbols SKD1, SKD2, etc.

When all higher levels of master keys are to be disallowed, suffix (NMK) to the symbol of the key which is to operate. This means "not master keyed" and can be applied to any level in the system. Cylinder AA1(NMK) is operated by AA1 only. The AA master, A grand and GGM are all blocked from operation. Cylinder AA(NMK) is operated by the AA master only. Grand A and the GGM do not operate. Cylinder A(NMK) would be operated by the A grand only, without the GGM.

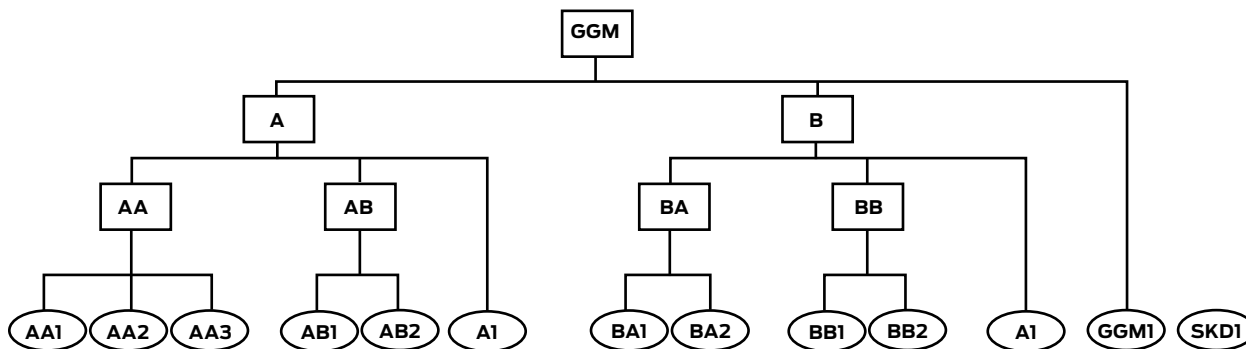

Selective master keys

It is often useful in large keying systems to issue a high level master key to maintenance personnel which allows access across all master and grand master key boundaries of a keying system. A selective master key is usually very close to the system's top master key, both physically and through its realm of access. Nevertheless, it must be blocked from operating in many areas.

To designate that a lock be operated by a selective master key, suffix the symbol in parentheses to the standard symbol. Example: AA1 (ENG). This must be added every time the selective key is to operate and left off whenever the selective key is NOT to operate. For instance, you may lay out a system in which key AA1 is to operate two different offices. Inside one of them is an electrical cabinet which must be accessible to maintenance personnel carrying the ENG key. That lock must be specified as AA1 (ENG) while the lock for the other office must be specified as AA1. Change keys directly under the selective key, such as ENG1, are operated by all higher level keys, such as GGM.

Like cross keying, a selective master key is a convenience feature which decreases the security of the cylinders it operates and limits the expansion and flexibility of the overall keying system.

The most common names and symbols for selective master keys

ENG=Engineer's key
JAN=Janitor's key
GRD=Guard's key

ATT=Attendant's key
HKP=Housekeeper's key
MAIN=Maintenance key

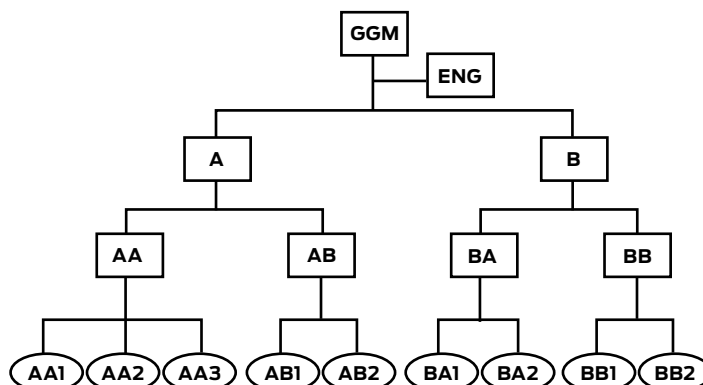

How to specify master keying

(continued)

Cross keying

Convenience may reduce cylinder security and hinder system expansion

Whenever two or more different keys such as AA1 and AA2 are both required to operate the same cylinder, the cylinder's security is reduced. This is called cross keying. When the cross keying occurs under all the same higher level keys, such as AA1 and AA2, it is known as controlled cross keying. When it combines keys under different higher level keys, such as AA1 and AB1, it is known as uncontrolled cross keying.

In addition to reducing the security of the cylinder, cross keying usually imposes limits on the flexibility and expansion of the overall keying system. This is especially true of uncontrolled cross keying. For these reasons, it is strongly recommended to allow personnel to carry more than one key. Cross keying should be discouraged whenever possible. However, when cross keying is required, it is specified as follows, and should be summarized at the beginning of each order.

Case #1

Cylinder requires its own change key. The illustration depicts part of a small medical building where two doctors share a common reception area. The receptionist gets the AA3 key. Each doctor carries a key which operates only one office, but is also cross keyed into the entrance from the corridor.

Determine the symbol of the change key (example: AA3). Then prefix the letter X (example: XAA3). Then list all keys which are to operate in an "operated by..." phrase. Example. "XAA3 operated by AA1, AA2, AA and A". Note that X is a cylinder specification only. The keys for cylinder XAA3 are designated AA3.

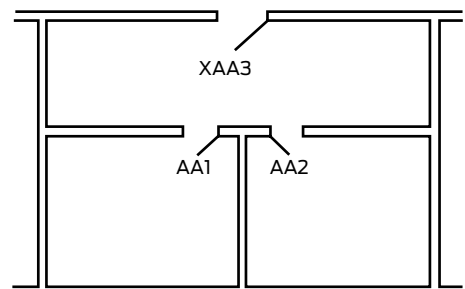

XAA3 Operated by AA1, AA2, AA and A

Case #2

A cylinder does NOT require its own change key. This illustration depicts a section of a floor in a dormitory. Each student's bedroom key operates the hall door lock. There is no need to construct a key which operates only the hall door.

In this case, place an X at both the beginning and end of the symbol and a number between them. Example: X1X, X2X, etc. Again, always include the "operated by..." phrase with a complete listing of key symbols to operate.

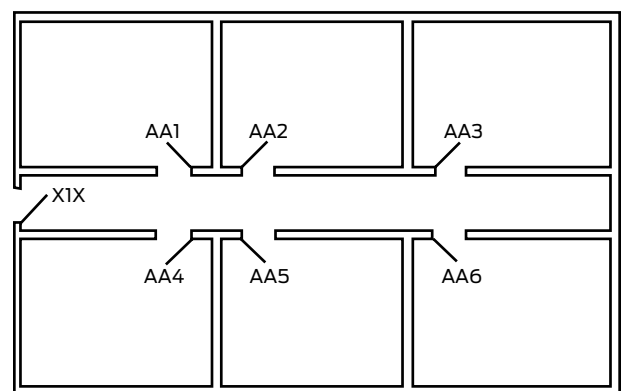

X1X Operated by AA1 through AA6, AA and A

Key and cylinder marking

With these options, keys and/or cylinders are stamped with the key symbol (code). This tells how the cylinder is keyed, eliminating trial and error. Lock mix-ups during installation or key mix-ups afterward are less likely to happen - and easier to straighten out if they do. For example, the symbol AA1 shown in the illustration identifies the lock to be operated by grand master key A, master key AA and change key AA1. Upon written authorization from the building owner to an authorized Falcon distributor, a bitting list can be furnished for each job to translate the symbols into key bittings. If a key is lost, a replacement key can be ordered by number from the Falcon distributor.

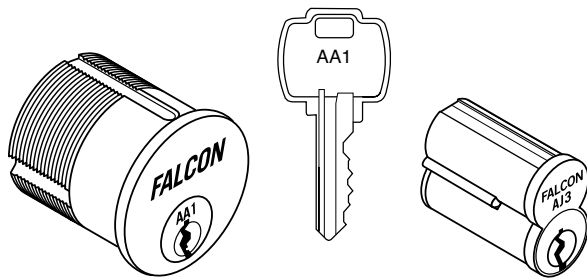

Visual key control (VKC)

For greater convenience

The key symbol is stamped on the plug face or other visible portion of the front of the cylinder. This makes identification fast and convenient. The disadvantage is that stolen or lost keys can be easily matched to the locks they operate. Also, restamping cylinders when they are rekeyed results in damage to the finish.

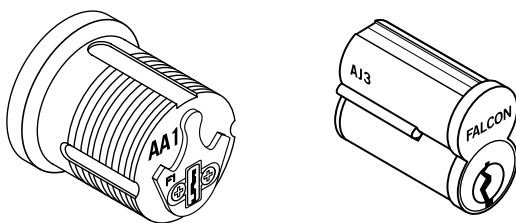

Concealed key control (CKC)

For greater security

For greater security, specify CKC on the cylinders. The key symbol is stamped in a concealed location, such as the rear of the cylinder or the side of an interchangeable core. It is not visible to the general occupants of the building but can be accessed by authorized personnel upon removal of the cylinder or core.

Standard cylinders

Conventional and auxiliary cylinders

Key-in-knob and lever cylinders

Regular function knobs and levers lockset	Pins	Cylinder
B except 611 function	5-pin	A23155-02
B except 611 function	6-pin	A23165-02
B611	5-pin	A23151-06
B611	6-pin	A23161-06
T381 Inside	5-pin	A23151-06
T381 Inside	6-pin	A23161-06
T381 Inside	7-pin	A23171-06
T571	5-pin	A23151-07
T571	6-pin	A23161-07
T571	7-pin	A23171-07
T all other functions	5-pin	A23151-05
T all other functions	6-pin	A23161-05
T all other functions	7-pin	A23171-05
W except 561 function (lever)	6-pin	Q330-154
W561 (lever)	6-pin	Q330-155
W except 561 function knob	6-pin	Q330-238
W561 (knob)	6-pin	Q330-246
X 561 -E and T designs	5-pin	A23151-00
X 561 -E and T designs	6-pin	A23161-00
X 411, 501, 511, 521, 581-E and T designs	5-pin	A23152-00
X 411, 501, 511, 521, 581-E and T designs	6-pin	A23162-00
X 411, 501, 511, 521, 581-H designs	5-pin	A23152-02
X 411, 501, 511, 521, 581-H designs	6-pin	A23162-02
X 411, 501, 511, 521, 581-H designs	7-pin	A23172-02
X 561-H designs	5-pin	A23151-02
X 561-H designs	6-pin	A23161-02
X 571-E and T designs	5-pin	A23151-02
X 571-E and T designs	6-pin	A23161-02
X 571-H designs	5-pin	A23151-03
X 571-H designs	6-pin	A23161-03
X 571-H designs	7-pin	A23171-02
X561-H designs	7-pin	A23171-01
Y all functions	5-pin	A23155-00
Y all functions	6-pin	A23165-00

Auxiliary lock cylinders

Deadlock lazy tailpieces lockset	Pins	Cylinder
D111, D141	5-pin	Q500-064
D121	5-pin	Q500-066
D131	5-pin	Q500-070
D111, D141	6-pin	Q500-021
D121	6-pin	Q500-058
D131	6-pin	Q500-054
D111, D141	7-pin	Q500-046
D121	7-pin	Q500-059
D211, D241	5-pin	Q500-067
D221	5-pin	Q500-069
D231	5-pin	Q500-072
D211, D241	6-pin	Q500-010
D221	6-pin	Q500-056
D231	6-pin	Q500-012
D211, D241	7-pin	Q500-014
D221	7-pin	Q500-057
Padlock	5-pin	A23151-01
Padlock	6-pin	A23161-01
Padlock	7-pin	A23171-00

"H" Series cylinder

Function	Pins	Cylinder
H 511 knobs	5-pin	A30040-00
H 511 knobs	6-pin	A30040-01
H all other functions and designs	5-pin	A30028-00
H all other functions and designs	6-pin	A30028-01

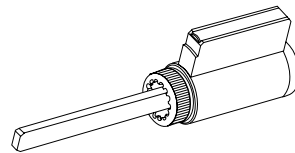

Specify keyway.
Specify finishes: 606, 626

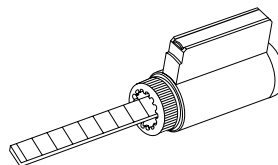

Sliding door cylinder
For use in Adams Rite 4024 and 4026 cylinder pulls typically used in patio doors.

950: Specify 5, 6, or 7-pin

Note: Specify finish: 606, 626

Standard cylinders

Competitor keyways

T Series	Cylinders
Corbin 60 O-bitted	A23167-011
Corbin 60 KD	A23167-11D
Corbin Russwin L4 O-bitted	A23174-011
Corbin Russwin L4 KA4	A23174-11A
Russwin D1 O-bitted	A23168-011
Russwin D1 KD	A23168-11D
Sargent LA O-bitted	A23166-011
Sargent LA KD	A23166-11D
Schlage C O-bitted	A23160-011
Schlage C KA4	A23160-11A
Schlage C KD	A23160-11D
Schlage E O-bitted	A23159-011
Yale EIR (8) Para O-bitted	A23169-011
Yale EIR (8) Para KD	A23169-11D
Corbin 60 O-bitted	A23167-012
Corbin 60 KD	A23167-12D
Corbin Russwin L4 O-bitted	A23174-012
Russwin D1 O-bitted	A23168-012
Russwin D1 KD	A23168-12D
Sargent LA O-bitted	A23166-012
Sargent LA KD	A23166-12D
Schlage C O-bitted	A23160-012
Schlage C KA4	A23160-12A
Schlage C KD	A23160-12D
Schlage E O-bitted	A23159-012
Yale EIR (8) Para O-bitted	A23169-012
Yale EIR (8) Para KD	A23169-12D
Corbin 60 O-bitted	A23167-000
Corbin 60 KD	A23167-0KD
Corbin Russwin L4 O-bitted	A23174-000
Russwin D1 O-bitted	A23168-000
Russwin D1 KD	A23168-0KD
Sargent LA O-bitted	A23166-000
Sargent LA KD	A23166-0KD
Schlage C O-bitted	A23160-000
Schlage C KA4	A23160-0KA
Schlage C KD	A23160-0KD
Schlage E O-bitted	A23159-000
Yale EIR (8) Para O-bitted	A23169-000
Yale EIR (8) Para KD	A23169-0KD

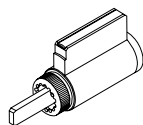

T381 Inside

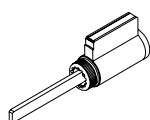

T571

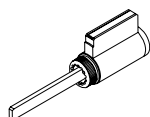

T Series
All other functions

X Series	Cylinders
Corbin 60 O-bitted	A23167-001
Corbin 60 KD	A23167-1KD
Corbin Russwin L4 O-bitted	A23174-001
Russwin D1 O-bitted	A23168-001
Russwin D1 KD	A23168-1KD
Sargent LA O-bitted	A23166-001
Sargent LA KD	A23166-1KD
Schlage C O-bitted	A23160-001
Schlage C KA4	A23160-1KA
Schlage C KD	A23160-1KD
Schlage E O-bitted	A23159-001
Yale EIR (8) Para O-bitted	A23169-001
Yale EIR (8) Para KD	A23169-1KD
Corbin 60 O-bitted	A23167-005
Corbin 60 KD	A23167-5KD
Corbin Russwin L4 O-bitted	A23174-005
Russwin D1 O-bitted	A23168-005
Russwin D1 KD	A23168-5KD
Sargent LA O-bitted	A23166-005
Sargent LA KD	A23166-5KD
Schlage C O-bitted	A23160-005
Schlage C KA4	A23160-5KA
Schlage C KD	A23160-5KD
Schlage E O-bitted	A23159-005
Yale EIR (8) Para O-bitted	A23169-005
Yale EIR (8) Para KD	A23169-5KD
Corbin 60 O-bitted	A23167-006
Corbin 60 KD	A23167-6KD
Corbin Russwin L4 O-bitted	A23174-006
Russwin D1 O-bitted	A23168-006
Russwin D1 KD	A23168-6KD
Sargent LA O-bitted	A23166-006
Sargent LA KD	A23166-6KD
Schlage C O-bitted	A23160-006
Schlage C KA4	A23160-6KA
Schlage C KD	A23160-6KD
Schlage E O-bitted	A23159-006
Yale EIR (8) Para O-bitted	A23169-006
Yale EIR (8) Para KD	A23169-6KD
Corbin 60 O-bitted	A23167-003
Corbin 60 KD	A23167-3KD
Corbin Russwin L4 O-bitted	A23174-003
Russwin D1 O-bitted	A23168-003

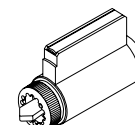

561
Elite and Troy

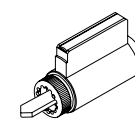

411, 501, 511, 521, 581
Elite and Troy

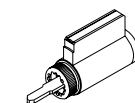

X411, 501, 511, 521, 581
Hana

X Series (continued)	Cylinders
Russwin D1 KD	A23168-3KD
Sargent LA O-bitted	A23166-003
Sargent LA KD	A23166-3KD
Schlage C O-bitted	A23160-003
Schlage C KA4	A23160-3KA
Schlage C KD	A23160-3KD
Schlage E O-bitted	A23159-003
Yale E1R (8) Para O-bitted	A23169-003
Yale E1R (8) Para KD	A23169-3KD
Corbin 60 O-bitted	A23167-004
Corbin 60 KD	A23167-4KD
Corbin Russwin L4 O-bitted	A23174-004
Russwin D1 O-bitted	A23168-004
Russwin D1 KD	A23168-4KD
Sargent LA O-bitted	A23166-004
Sargent LA KD	A23166-4KD
Schlage C O-bitted	A23160-004
Schlage C KA4	A23160-4KA
Schlage C KD	A23160-4KD
Schlage E O-bitted	A23159-004
Yale E1R (8) Para O-bitted	A23169-004
Yale E1R (8) Para KD	A23169-4KD

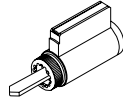

X571
Elite and Troy

X561
Hana

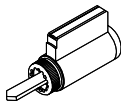

X571
Hana

B Series	Cylinders
Corbin 60 O-bitted	A23167-011
Corbin 60 KD	A23167-11D
Corbin Russwin L4 O-bitted	A23174-011
Russwin D1 O-bitted	A23168-011
Russwin D1 KD	A23168-11D
Sargent LA O-bitted	A23166-011
Sargent LA KD	A23166-11D
Schlage C O-bitted	A23160-011
Schlage C KA4	A23160-11A
Schlage C KD	A23160-11D
Schlage E O-bitted	A23159-011
Yale E1R (8) Para O-bitted	A23169-011
Yale E1R (8) Para KD	A23169-11D
Corbin 60 O-bitted	A23167-013
Corbin 60 KD	A23167-13D
Corbin Russwin L4 O-bitted	A23174-013
Russwin D1 O-bitted	A23168-013
Russwin D1 KD	A23168-13D
Sargent LA O-bitted	A23166-013
Sargent LA KD	A23166-13D
Schlage C O-bitted	A23160-013
Schlage C KA4	A23160-13A
Schlage C KD	A23160-13D
Schlage E O-bitted	A23159-013
Yale E1R (8) Para O-bitted	A23169-013
Yale E1R (8) Para KD	A23169-13D

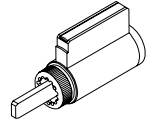

B611

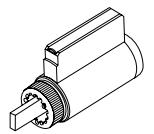

B Series
All other functions

Specify cylinder number, keyway and finish when ordering.

Standard cylinders

Competitor keyways (continued)

Y Series	Cylinders
Corbin 60 O-bitted	A23167-008
Corbin 60 KD	A23167-8KD
Corbin Russwin L4 O-bitted	A23174-008
Russwin D1 O-bitted	A23168-008
Russwin D1 KD	A23168-8KD
Sargent LA O-bitted	A23166-008
Sargent LA KD	A23166-8KD
Schlage C O-bitted	A23160-008
Schlage C KA4	A23160-8KA
Schlage C KD	A23160-8KD
Schlage E O-bitted	A23159-008
Yale E1R (8) Para O-bitted	A23169-008
Yale E1R (8) Para KD	A23169-8KD

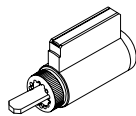

Y Series
All functions
and designs

D Series	Cylinders
Corbin Russwin L4 O-bitted	Q033-079
Russwin D1 O-Bitted	Q033-074
Russwin D1 KD	Q033-074
Schlage C O-bitted	Q033-071
Schlage C KA4	Q033-071
Schlage C KD	Q033-071
Schlage E O-bitted	Q033-068
Yale E1R (8) Para KD	Q033-076
Corbin Russwin L4 O-bitted	Q033-078
Russwin D1 O-bitted	Q033-073
Russwin D1 KD	Q033-073
Schlage E O-bitted	Q033-067
Corbin 60 O-bitted	Q033-077
Corbin 60 KD	Q033-077
Russwin D1 O-bitted	Q033-072
Russwin D1 KD	Q033-072
Schlage C O-bitted	Q033-070
Schlage C KA4	Q033-070
Schlage C KD	Q033-070
Schlage C O-bitted	Q033-069
Schlage C KA4	Q033-069
Schlage C KD	Q033-069
Yale E1R (8) Para KD	Q033-075

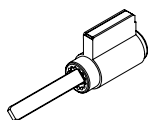
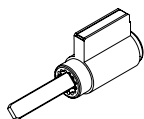

H Series	Cylinders
Corbin 60 O-bitted	A23167-007
Corbin 60 KD	A23167-7KD
Corbin Russwin L4 O-bitted	A23174-007
Russwin D1 O-bitted	A23168-007
Russwin D1 KD	A23168-7KD
Sargent LA O-bitted	A23166-007
Sargent LA KD	A23166-7KD
Schlage C O-bitted	A23160-007
Schlage C KA4	A23160-7KA
Schlage C KD	A23160-7KD
Schlage E O-bitted	A23159-007
Yale E1R (8) Para O-bitted	A23169-007
Yale E1R (8) Para KD	A23169-7KD
Corbin 60 O-bitted	A23167-010
Corbin 60 KD	A23167-10D
Corbin Russwin L4 O-bitted	A23174-010
Russwin D1 O-bitted	A23168-010
Russwin D1 KD	A23168-10D
Sargent LA O-bitted	A23166-010
Sargent LA KD	A23166-10D
Schlage C O-bitted	A23160-010
Schlage C KA4	A23160-10A
Schlage C KD	A23160-10D
Schlage E O-bitted	A23159-010
Yale E1R (8) Para O-bitted	A23169-010
Yale E1R (8) Para KD	A23169-10D

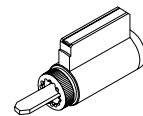

H 511
All knobs

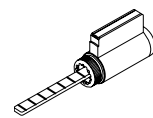

H Series
deadbolt

Padlocks	Cylinders
Corbin 60 O-bitted	A23167-002
Corbin 60 KD	A23167-2KD
Corbin Russwin L4 O-bitted	A23174-002
Russwin D1 O-bitted	A23168-002
Russwin D1 KD	A23168-2KD
Sargent LA O-bitted	A23166-002
Sargent LA KD	A23166-2KD
Schlage C O-bitted	A23160-002
Schlage C KA4	A23160-2KA
Schlage C KD	A23160-2KD
Schlage E O-bitted	A23159-002
Yale E1R (8) Yale Para O-bitted	A23169-002
Yale E1R (8) Yale Para KD	A23169-2KD

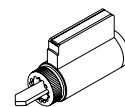

Padlocks

Standard cylinders

Key blanks and keys

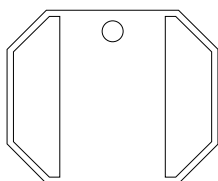
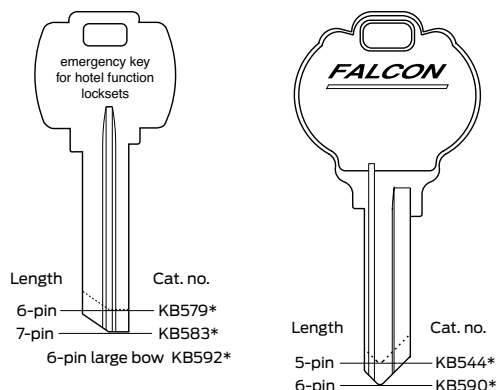
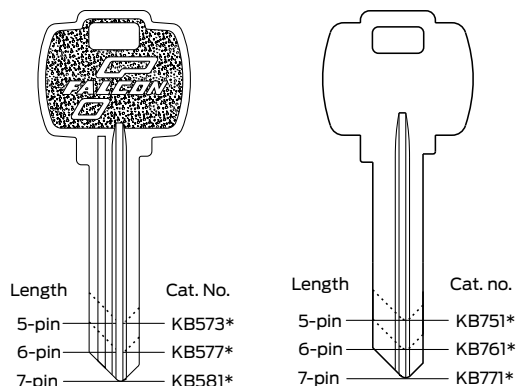

Access bow
2" access bow is made of blue plastic and meets requirements of Title 24 of the California Code for Handicapped.

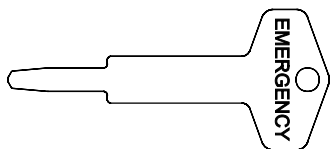

Emergency tool
012727-000-30 for Mortise privacy locks M301, M311, M321

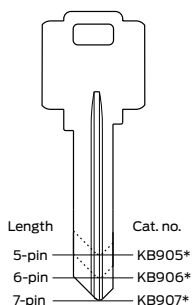

Access key blank
After cutting, press into blue plastic bow shown above. Order blanks and bows separately.

Key blanks (multiples of 50 except where noted)

Description	Standard	Plain both sides
5-pin standard	KB573*	KB751*
6-pin standard	KB577*	KB761*
7-pin standard	KB581*	KB771*
5-pin large bow (25/box)	KB544*	—
6-pin large bow (25/box)	KB590*	—
6-pin emergency MK	KB579*	—
7-pin emergency MK	KB583*	—
6-pin EMK, large bow (25/box)	KB592*	—
5-pin blade for access bow	KB573-1*	—
6-pin blade for access bow	KB577-1*	—
7-pin blade for access bow	KB581-1*	—
6-pin Schlage C blank	Q330-215	—
Plastic access bow only	001911-001-70	—
Blockokey® construction key	KB525	—

* Suffix key section to catalog number. Example: KB573G

Cut keys

Description	Standard	Plain both sides
5-pin	KB574	KB794
6-pin	KB578	KB797
7-pin	KB582	KB799
Large bow 5-pin	KB545	—
Large bow 6-pin	KB591	—
5-pin construction MK	KB565	—
6-pin construction MK	KB566	—
7-pin construction MK	KB567	—
6-pin emergency MK	KB580	—
7-pin emergency MK	KB584	—
6-pin EMK, large bow	KB593	—
Handicap bow 5-pin	KB905	—
Handicap bow 6-pin	KB906	—
Handicap bow 7-pin	KB907	—
6-pin Schlage C	330055	—
6-pin Schlage split key	Q330-276	—
Blockokey® construction key	KB531	—

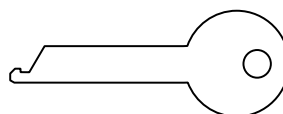

KB536
Removal tool for Blockokey construction keying key block.

Standard cylinders

Tailpieces



Kit 1389

Contains cap tool and most parts on this page, except hotel function and 7-pin tailpieces

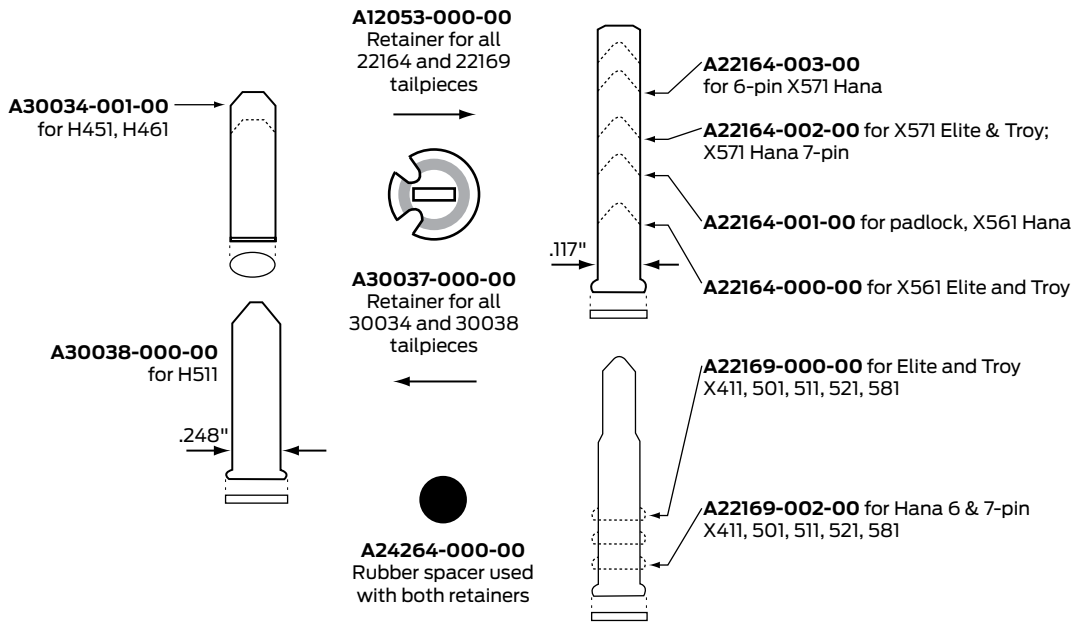
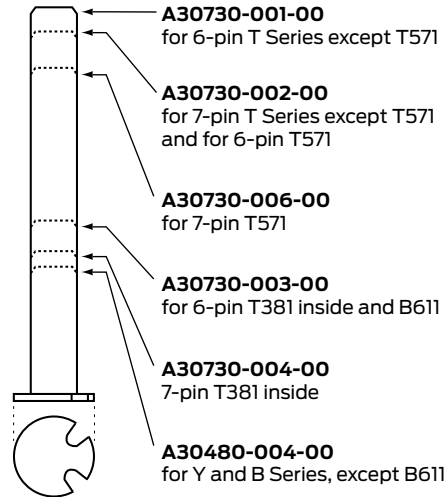
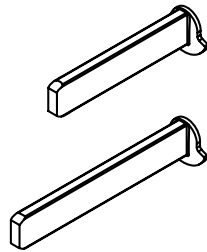

D Series lazy tailpiece, standard cylinder

For 7-pin applications, break tailpiece to next shorter length.

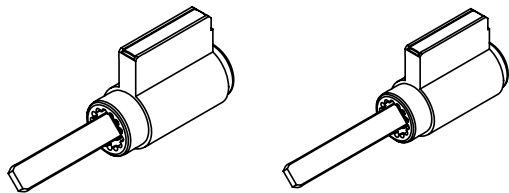

Rim cylinder tailpieces

With 008355 Retainer

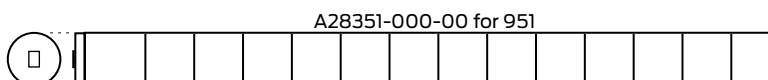

Standard cylinders

Accessories

Service equipment and supplies

Pin kits

- 1418 Standard
(includes key gauge, follower and cylinder cap tool)
- 1417 Restricted keyways
(includes key gauge, follower and cylinder cap tool)

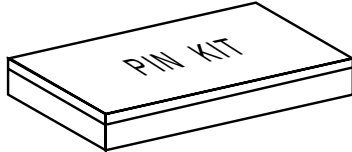

Key gauge

- 030113-000-60 Standard keyways
.018" increment
- 042613-000-60 Restricted keyways
.025" increment

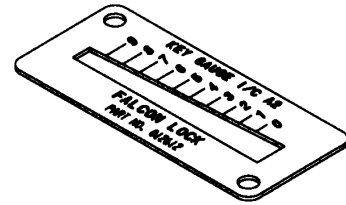

Kit refills: pins and springs

- A08553-00-00 Bottom pins for standard keyways*
- A08580-00-00 Master pins for standard keyways*
- A08552-000-00 Top pins, 100-pack
- A08554-000-00 Tumbler springs, 100-pack

*sizes 2 thru 9, 100-pack

Miscellaneous cylinder parts

- A02750-000-00 Cam screw 100-pack
- 031100-000-30 Hex nut for cam lock and mortise cylinders
- 012162-000-10 Cylinder cap for Falcon keyway cylinders only.
- A12165-000-00 Cap retaining pin for Falcon keyway cylinders only, 10-pack
- A12166-000-00 Spring for retaining pin for Falcon keyway cylinders only, 100-pack

Other service equipment

- 1416 Cylinder cap tool - steel
- 1421 Plug follower

Interchangeable core

Advantages

Interchangeable core (I/C) offers maximum flexibility to the building owner. Whenever a key is lost or stolen, locks can be rekeyed quickly by non-locksmith personnel. All it takes is the special "control" key. This key is used to remove and install all cores in the system. Just go to the door, remove the old core and install the new one with the control key. Security is regained in seconds!

Falcon's interchangeable cores and I/C locksets are compatible with other small format interchangeable core (SFIC) products, such as Best and Arrow. Use our locks with their cores and vice versa. In most cases Falcon can even furnish cores master keyed into your existing Best or Arrow key system. Just include a copy of your existing bitting list with the order.



Construction cores

Interchangeable core jobs requiring construction keying are furnished with temporary cores which are keyed alike to a combination unrelated to the permanent system's master key. When the building is turned over to the owner, the permanent cores are installed and the construction cores are returned to Falcon Lock for credit. Orders must include the name and address of the person to whom the construction keys and permanent master and change keys should be sent.

Interchangeable core keyways

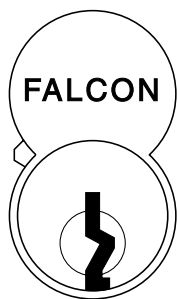

The "A" keyway is standard for I/C products and will be supplied unless otherwise specified. Falcon keyways shown here are equivalent to Best and Arrow I/C keyways of the same names.

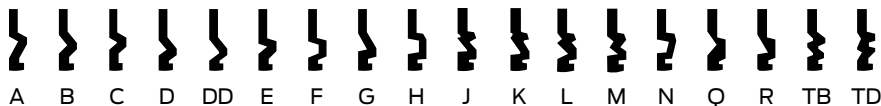

Consult factory for restricted keyways not listed here.

When ordering locks or cores master keyed into existing Best, Arrow or other compatible I/C systems, a copy of the bitting list for the existing system is required with the order.

A2, A3 and A4 Systems

Falcon master keying uses the A2 System (depths 0-9) standard. We can provide cores into competitors' A4 (depths 0-5) key systems but we generate new A4 systems solely at the discretion of our Key Systems Department. We do not support the A3 System (Depths 0-6). However, any Falcon core can be combined to A3 specs in the field.

Interchangeable core

(continued)

Cores

Description: Uncombined cores are supplied without pins, springs or keys. May be keyed into A2, A3 and A4 Systems in the field. Combined cores are keyed and ready to install, and are furnished with two change keys each. A2 System standard, A4 special. See page 20 for details.

Packaging: Uncombined cores are packed 20 per box.

Finishes: Standard: 606 and 626.

Special Order: 605, 613 and 625.

Logo: Standard - Cores and keys are supplied with the Falcon logo.

Optional: Combined cores ordered without logo are furnished with plain (non-embossed) keys.

Interchangeable core

Available with Falcon style spring cover (shown) or Best® style individual pin chamber caps. See table for product numbers.

Standard cores use a single spring cover to seal pin chambers.

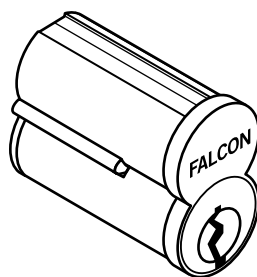

With Best® style capping, each pin chamber is sealed with its own individual cap.

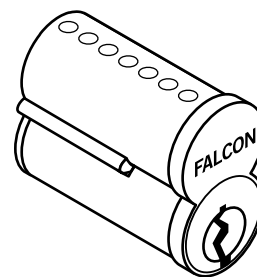

Regular core (suffix keyway to number)

	Uncombined		Combined	
	6-pin	7-pin	6-pin	7-pin
Standard	C646	C647	C606	C607
Best® style capping	CB846	CB847	CB806	CB807
No logo	C648	C649	C608	C609
No logo, Best® capping	CB848	CB849	CB808	CB809

Note: Specify core number, keyway and finish when ordering.

Interchangeable core

Keys and key blanks

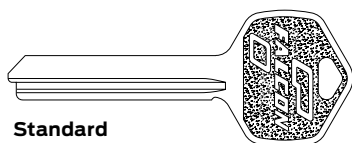

Standard

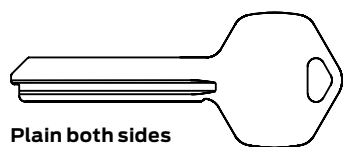

Plain both sides
(non-embossed)

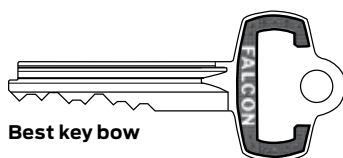

Best key bow

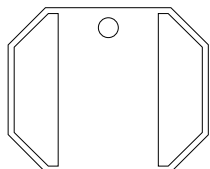

Access bow

2" access bow is made of blue plastic and meets requirements of Title 24 of The California Code for Handicapped.

Key Blanks (suffix key section)

Description	Standard	Plain both sides
Standard	KB628*	KB718*
Best style	KB800	KB801
Stamped CONTROL	KB608*	KB744*
MA Series EMERGENCY	KB737*	KB748*
Best style MA Series EMERGENCY	KB804	KB805
Blade for 2" access bow	KB633*	n/a
Plastic access bow only	001911-001-70	n/a

Cut key (suffix keyway)

Description	Standard		Plain both sides	
	6-pin	7-pin	6-pin	7-pin
Standard	KB632-1	KB632-2	KB673-1	KB673-2
Best Style	KB807-1	KB807-2	KB809-1	KB809-2
CONTROL	KB609-1	KB609-2	KB778-1	KB778-2
Best Style CONTROL	KB811-1	KB811-2	KB813-1	KB813-2
MA Series EMERGENCY	KB738-1	KB738-2	KB779-1	KB779-2
Best Style MA Series EMERGENCY	KB814-1	KB814-2	KB817-1	KB817-2
2" access bow	KB916	KB916-1	n/a	n/a

* Extensive key systems sometimes require more than one keyway. Double, triple, quadruple and quintuple-milled keys must then be furnished for top master and control keys. Only certain milling combinations are practical. Common multi-section keys include AB, AE, DE, EF, FG, AEG, DEF, EFG, DEFG, JKLM, ADEFG.

Emergency key blanks

For C262 and C265 hotel function mortise cylinders.

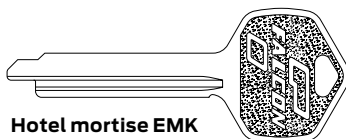

Hotel mortise EMK

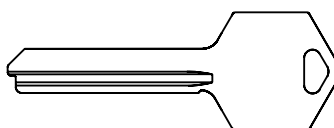

Access key blank

After cutting, press into blue plastic bow shown above. Order blanks and bows separately.

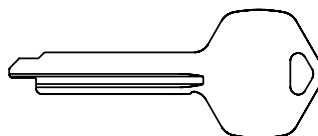

Plain both sides
(non-embossed)

Interchangeable core

Tailpieces and construction keying

Cylindrical lock tailpieces

Throw members shown actual size.

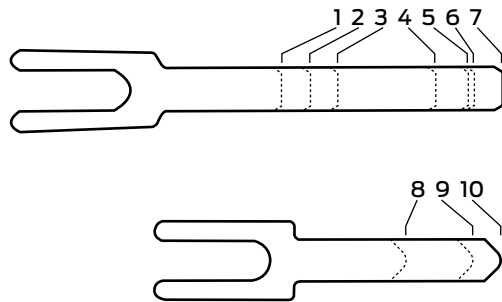

B, RU, T, W and X Series

Ref.	Length	Part number	Application
1	1.40"	022175-000-30	X Series, except X571
2	1.53"	030739-003-30	RU, T381 inside only, 7-pin, B611
3	1.69"	030739-002-30	RU, T381 inside only, 6-pin, B611
4	2.22"	030739-005-30	RU, T571 7-pin
5	2.37"	030739-004-30	RU, T571 6-pin
6	2.41"	030739-001-30	RU, T Series 7-pin except T381 inside and T571
7	2.56"	030739-000-30	RU, T Series 6-pin except T381 inside and T571
8	1.32"	031731-000-30	B Series 6 and 7-pin, except B611
9	1.66"	022175-002-30	X571 7-pin, B611 7-pin
10	1.81"	022175-001-30	X571 6-pin
11	X.XX"	Q330-164	W Series 501, 511, 581, 711 functions
12	X.XX"	Q330-165	W Series 561 function

Y Series

Q001-055

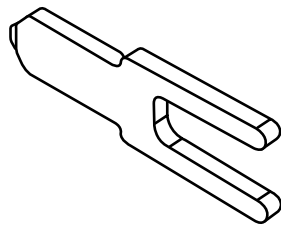

Rim cylinder tailpiece

With 012698 retainer

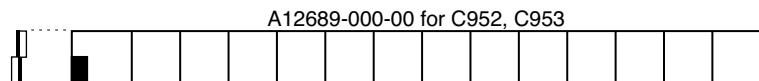

“Disposable construction” core

1408 Disposable small format
Interchangeable construction core

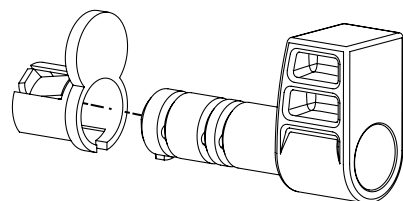

For more options and information on construction keying, please consult page 16 of this catalog.

Interchangeable core

Accessories

Key biting punch

1208 A2 system

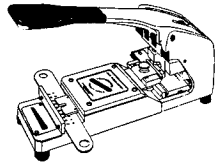

Stamping fixture

1398 Holds one key and one core for face or side marking

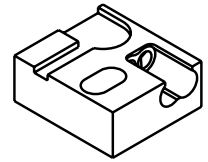

Key gauge

012612-000-60 A2 system

030425-000-60 A4 system

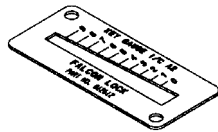

Pin kit

1404 A2 System, Falcon spring cover cores (standard)

1391 A2 System, Best® style capping

1403 A4 System, Falcon spring cover cores

1390 A4 System, Best® style capping

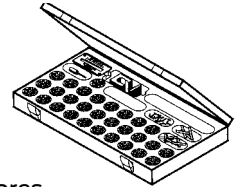

Depth bars for key machine

031033-000-30 A3 system

031034-000-30 A4 system

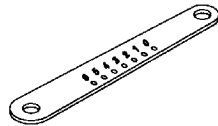

Capping pin and ejector pin

1392 Capping pin, Best® style

1405 Ejector tool

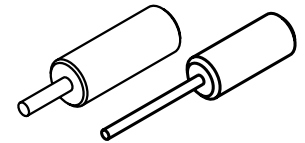

Miscellaneous I/C parts

A12663-001-00 Drive pins, package of ten (10)

A12664-010-00 Drive washer, package of ten (10)

Kit Refills: Pins, springs, etc. (100-pack except where noted)

A12635-0xx-00 A2 top pins, sizes 2 thru 19: replace "xx" with size

A12636-00x-00 A2 bottom pins, sizes 0 thru 9: replace "x" with size

A30375-0xx-00 A4 top pins, sizes 1 thru 11: replace "xx" with size

A30376-00x-00 A4 bottom pins, sizes 0 thru 5: replace "x" with size

A12637-000-00 Tumbler spring

A12637-500-00 Tumbler spring, 500-pack

A12638-000-00 21C caps for Best® style cores, 500-pack

A12639-001-00 Spring cover, 6-Pin

A12639-002-00 Spring cover, 7-Pin

Capping blocks

1411 Set, Falcon spring cover cores

1414 Block only, Falcon spring cover cores

1415 Tapping plate - new style (dovetail)

1393 Capping block, Best® style capping

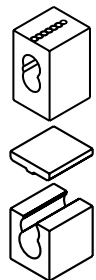

Mortise accessories

Mortise cam changing tools

1400 Tool set with staking punch

1401 Tool only

1402 Cam staking punch only

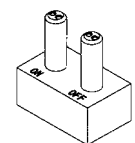

Mortise cylinder wrench

1407 Verifies cam operation and preserves cylinder finish during installation

002807-000-30 Mortise I/C cylinder security screw

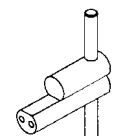

Mortise cylinders

Mortise, rim and cam lock cylinders

Mortise, rim and cam lock for standard cylinders

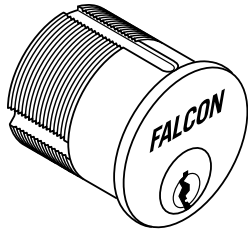

Note: Specify finish - 605, 606, 613, 626, 629, 630

Mortise cylinder

900 Series cylinders are furnished with 5622-STD and 250 Series with 5622-STD unless otherwise specified.

See table for product numbers.

See pages 24-25 for optional cams and 26-27 for collars.

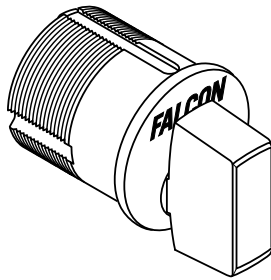

Note: Specify finish - 605, 606, 613, 626, 629, 630

Thumbturn cylinder

Furnished with 5622-STD except 970 Series furnished with 5622-STD unless otherwise specified.

See table for product numbers.

See pages 24-25 for optional cams and 26-27 for collars.

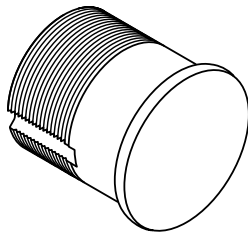

Note: Specify finish - 605, 606, 613, 625, 626

Dummy cylinder

Used to plug hole in door where lock remains but cylinder operation is no longer needed.

984D 1"
985D 1 1/8"

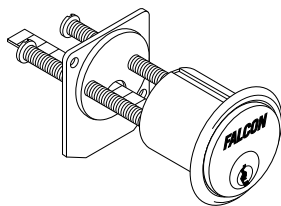

Note: Specify finish - 605, 606, 613, 626, 629, 630

Rim cylinder

Horizontal tailpiece standard. May be changed to vertical orientation in the field. Furnished with collar, back plate and 12-24 break off screws.

951 Specify 5, 6 or 7-pin

Keyed mortise cylinders

Catalog number	Length	Pins	Application
985	1 1/8"	5 or 6	Generic
986	1 1/4"	5 or 6	Generic
987	1 3/8"	6 or 7	Generic
988	1 1/2"	6 or 7	Generic
990	1 3/4"	6 or 7	Generic
992	2"	6 or 7	Generic
250	1 1/8"	6	MA451 hotel function
251	1 1/4"	6	MA451 hotel function
252	1 3/8"	6	MA451 hotel function
253	1 3/8"	7	MA451 hotel function

Thumbturn mortise cylinders

Catalog number	Length	Pins	Application
985T	1 1/8"	—	Generic
986T	1 1/4"	—	Generic
973	1 1/8"	—	M911 Classroom thumbturn, RH (CCW)
974	1 1/8"	—	M911 Classroom thumbturn, LH (CW)

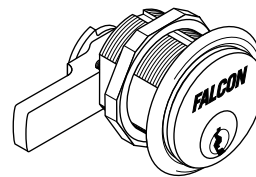

Note: Specify finish - 605, 606, 613, 626, 629, 630

Cam lock - heavy cam

Includes stop washers for rigid and lazy cam operation. Field reversible for RH or LH doors by positioning of stop screw on back of housing. Requires 1 3/8" cylinder hole and fits doors up to 1 1/8" thick.

945 Specify 5 or 6-pin

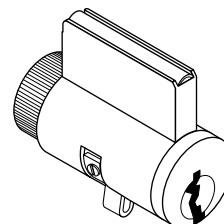

Note: Specify finish - 606, 626

Mailbox cylinder

U.S. Postal regulations prohibit master keying of mailbox locks. Mailboxes must be ordered specifically for Falcon cylinders from the mailbox manufacturer.

954 Specify 5, 6 or 7-pin

Specify cylinder number, keyway and finish when ordering.

Mortise cylinders

Mortise, rim and cam lock housing

Mortise, rim and cam lock for standard cylinders

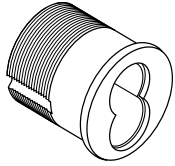

Note: Specify finishes - 605, 606, 613, 626, 629, 630

Mortise cylinder housing

Standard housings furnished with 5622-IC and hotel function housings furnished with 5622-IC. See table for product numbers.

See pages 24-25 for optional cams and pages 26-27 for collars.

Catalog number	Length	Pins	Application
C987	1 3/8"	6 or 7	Generic
C988	1 1/2"	6 or 7	Generic
C990	1 3/4"	6 or 7	Generic
C992	2"	6 or 7	Generic
C997	1 3/8"	6 or 7	Unassembled, less cam
C262	1 5/8"	6 or 7	MA451 Hotel function RH
C265	1 5/8"	6 or 7	MA451 Hotel function LH

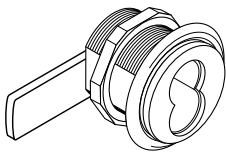

Note: Specify finishes - 605, 606, 613, 626, 629, 630

Cam lock

Key removable in locked position only. Cam rotates 360° and can be installed for right or left hand operation. Requires 1 3/16" cylinder hole and fits doors up to 1 3/8" thick.

C943 Specify 6 or 7-pin

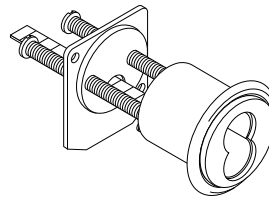

Note: Specify finishes - 605, 606, 613, 626, 629, 630

Rim cylinder housing

Horizontal tailpiece standard. May be changed to vertical orientation in the field. Furnished with collar, back plate and 12-24 break-off screws.

C953 Specify 6 or 7-pin

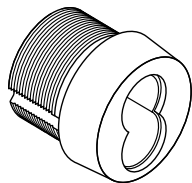

Note: Specify finishes - 605, 606, 613, 625, 626

Adams rite tapered head mortise cylinder housing

Designed for proper fit without collars on narrow stile aluminum doors. Furnished with #8 Adams Rite cam.

C977 Specify 6 or 7-pin

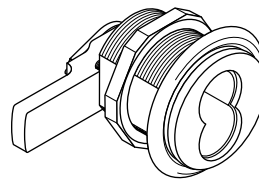

Note: Specify finishes - 605, 606, 613, 626, 629, 630

Cam lock - heavy cam

Includes stop washers for rigid and lazy cam operation. Field reversible for RH or LH doors by positioning of stop screw on back of housing. Requires 1 3/16" cylinder hole and fits doors up to 1 1/8" thick.

C945 Specify 6 or 7-pin

How to order

Less core

Specify catalog number and finish. Example: C987 626

Complete with core

Add keyway, "WIC" and keying instructions. Example: C987 WIC A* 626 AA12

* "A" keyway standard. Falcon reserves the right to assign the keyway for new key systems.

Mortise cylinders

Cams

Falcon

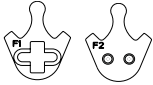
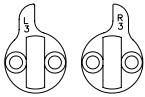
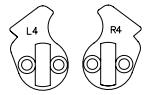
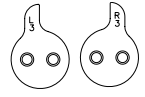
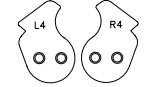
Diagram	Lock	Reference number	Part number	For cylinder
	Falcon MA Series	F1 F2	5622-STD 5622-IC	Conventional I/C
	Falcon MA Series	L3 R3	5620-STD	Conventional, MA381 inside function
	Falcon MA Series	L4 R4	5621-STD	Conventional, MA381 outside function
	Falcon MA Series	L3 R3	5620-IC	I/C, MA381 inside function
	Falcon MA Series	L4 R4	5621-IC	I/C, MA381 outside function

Falcon exit devices

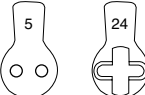
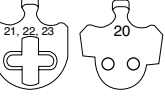
Diagram	Lock	Reference number	Part number	For cylinder
	Dogging cylinder Install cam upside down.	24 5	A09897-024-00 A12667-003-00	Conventional I/C
	Delta trim for 17C concealed vertical rod for 718 Series trim manufactured prior to July 2011	21 22 23 20	A09894-021-00 A09894-022-00 A09894-023-00 A12667-020-00	Falcon, Ilco, Lori, Schlage Arrow, Sargent & Yale Corbin Russwin I/C

Schlage

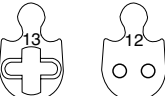
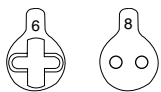
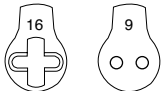
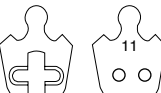

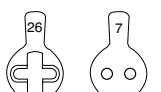

Diagram	Lock	Reference number	Part number	For cylinder
	Schlage L Series	13 12	A09888-000-00 A12667-008-00	Conventional I/C

Note: Each part number indicates a package of 10 cams

Mortise cylinders

Cams (continued)

Other manufacturers

Diagram	Lock	Reference number	Part number	For cylinder
	Adams Rite MS, 4500 and 4700 Series	6 8	A09899-000-00 A12667-001-00*	Conventional I/C
	Adams Rite 4070 deadlock	16 9	A09898-000-00 A12667-002-00	Conventional I/C
	Arrow, Corbin Russwin ML2200 except ML2255 and ML2242 inside	- 11	A20069-000-00 A12667-011-00	Conventional I/C
	Corbin Russwin DL4000 Series	27	A12677-013-00	I/C
	Corbin Russwin master ring black cast iron locks only. Requires brushing A09890-000-00	25	A12667-006-00	Conventional I/C Most exit devices
	Sargent & Yale	26 7	A08867-000-00 A12667-000-00	Conventional I/C
	Sargent 7737	-	A12667-03A-00*	I/C

* Thick cams require throw pin A12663-003-00

Note: Each part number indicates a package of 10 cams

Cam assortment kits

1396 Standard cylinders

Contains ten each #1, 4 and 13; fifteen #6 and five each #2, 3 and 14 cams, plus 50 cam screws and a plug follower.

1397 I/C Mortise cylinders

Contains ten each #5, 7, 10, 11 and 12; twenty #8 and five #15 cams, a supply of throw member pins and plates, and one #1402 staking punch.



Mortise cylinders

Cylinder collars

Standard collars for cylinders ordered separately

Length	Cylinder	Non-AR Cams	AR Cam
1"	984D	A08794-000	—
1 1/8"	250, 965, 966, 973, 974, 985 Series	A08794-000	008876-002
1 1/4"	251, 986 Series	A08794-001	008876-003
1 3/8"	252, 253, 987, C987, C997	A08794-002	008876-004
Longer	C260 Series, (C)988, (C)990, (C)992	A08794-000	008876-000

Escutcheon trim ring

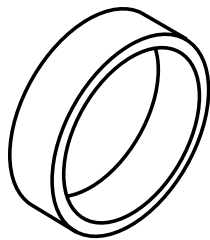

Door thickness	Function	985 1 1/8"	986 1 1/4"	(C)987 1 3/8"	(C)988 1 1/2"
1 1/2"	Single cylinder	—	A08790-000	A08790-001	A08790-002
1 1/2"	Double cylinder	A08790-000	—	—	—
1 3/4"	Single cylinder	—	—	A08790-000	A08790-001
1 3/4"	Double cylinder	—	A08790-000	A08790-001	A08790-002
2"	Single cylinder	—	—	A08790-000	A08790-001
2"	Double cylinder	—	—	A08790-000	A08790-001
2 1/4"	Single cylinder	—	—	—	A08790-000
2 1/4"	Double cylinder	—	—	—	—
2 1/2"	Single cylinder	—	—	—	—
2 1/2"	Double cylinder	—	—	—	—

Sectional trim ring

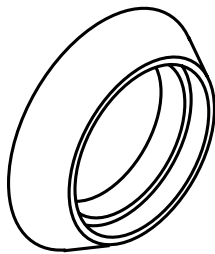

Door thickness	Function	985 1 1/8"	986 1 1/4"	(C)987 1 3/8"	(C)988 1 1/2"
1 1/2"	Single cylinder	A08794-001	A08794-002	—	—
1 1/2"	Double cylinder	A08794-002	A08794-003	—	—
1 3/4"	Single cylinder	A08794-000	A08794-001	A08794-002	—
1 3/4"	Double cylinder	A08794-001	A08794-002	A08794-003	—
2"	Single cylinder	—	A08794-000	A08794-001	A08794-002
2"	Double cylinder	A08794-000	A08794-001	A08794-002	A08794-003
2 1/4"	Single cylinder	—	—	A08794-000	A08794-001
2 1/4"	Double cylinder	—	A08794-000	A08794-001	A08794-002
2 1/2"	Single cylinder	—	—	—	A08794-000
2 1/2"	Double cylinder	—	—	A08794-000	A08794-001

Note: Specify part number and finish when ordering.
(e.g. A08790-000-626)

Mortise cylinders

Cylinder collars (continued)

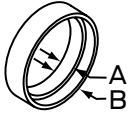
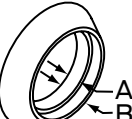
	Dim. A	Dim. B	Part No.
	$\frac{3}{32}$ "	$\frac{9}{32}$ "	A08790-000
	$\frac{7}{32}$ "	$\frac{13}{32}$ "	A08790-001
	$\frac{11}{32}$ "	$\frac{17}{32}$ "	A08790-002
	$\frac{15}{32}$ "	$\frac{21}{32}$ "	A08790-003
	$\frac{43}{64}$ "	$\frac{55}{64}$ "	A08790-004
	$\frac{3}{32}$ "	$\frac{9}{32}$ "	A08794-000
	$\frac{7}{32}$ "	$\frac{13}{32}$ "	A08794-001
	$\frac{11}{32}$ "	$\frac{17}{32}$ "	A08794-002
	$\frac{15}{32}$ "	$\frac{21}{32}$ "	A08794-003
	$\frac{1}{8}$ "	—	008876-000
	$\frac{3}{16}$ "	—	008876-005
	$\frac{1}{4}$ "	—	008876-001
	$\frac{3}{8}$ "	—	008876-002
	$\frac{1}{2}$ "	—	008876-003
	$\frac{5}{8}$ "	—	008876-004

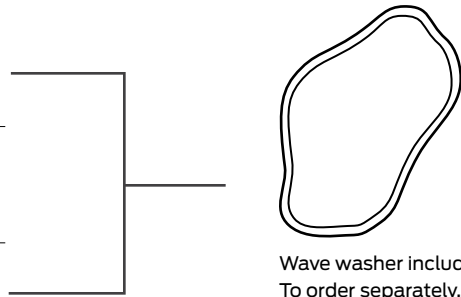

Wave washer included.
To order separately, specify
008789-001-60

Note: Specify part number and finish when ordering.
(e.g. A08790-000-626)

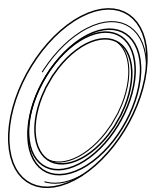

008862-000

For all rim cylinders and cam locks.

Note: Specify finishes: 605, 606, 612, 613, 625, 626

About Allegion

Allegion (NYSE: ALLE) is a global pioneer in safety and security, with leading brands like CISA®, Interflex®, LCN®, Schlage® and Von Duprin®. Focusing on security around the door and adjacent areas, Allegion produces a range of solutions for homes, businesses, schools and other institutions. Allegion is a \$2 billion company, with products sold in almost 130 countries.

For more, visit www.allegion.com

aptiQ ■ LCN ■ **SCHLAGE** ■ STEELCRAFT ■ VON DUPRIN