



# Mechanical and Electronic Locks

**PRICE LIST 69BST**

EFFECTIVE: APRIL 8, 2019





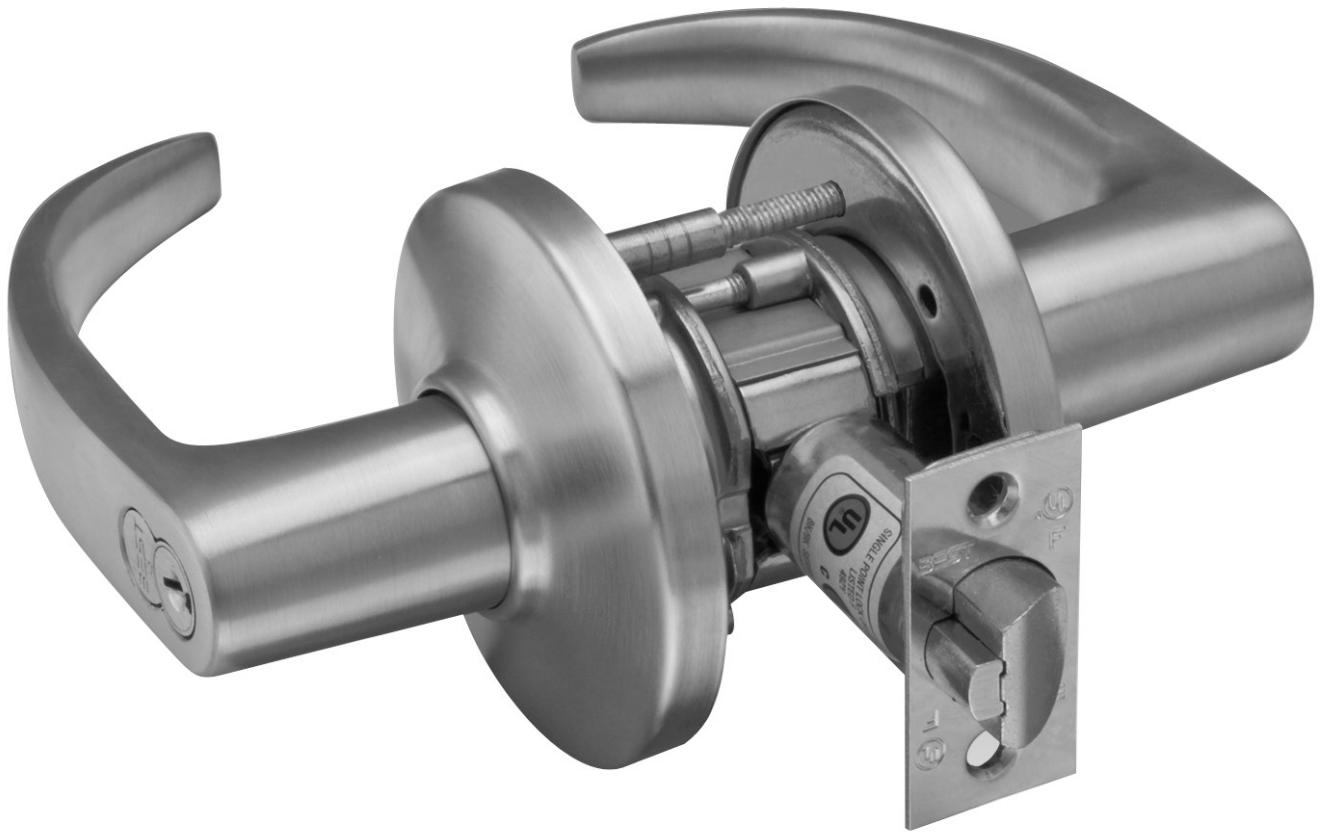

**NOTE:** Please contact us for price information on specialty items or options not shown in this price list.

dormakaba USA Inc. reserves the right to make changes in designs and specifications or to make additions or improvements to its products without notice and without incurring any obligation to incorporate them on products previously manufactured.



## Contents

|  |    |  |     |
|--|----|--|-----|
| Sales Policies                                     | 5  | W Series Electric Switch Locks                                     | 57  |
| Warranty   | 7  | 45HW Series Electromechanical Mortise Locks                        | 58  |
| BEST Patented Product Offering                     | 9  | 47HW Series High Security Electromechanical Mortise Locks          | 59  |
| BEST Masterkey Code and Masterkey Service Policy   | 11 | 8KW/9KW Series Electromechanical Cylindrical Locks                 | 60  |
| Architectural Finishes                             | 13 | Electromechanical Lock Accessories                                 | 61  |
| BEST Standard & Premium Keys                       | 14 | Electric Strike and Strike Accessories                             | 62  |
| BEST Peaks Keys                                    | 15 | Electromagnetic Locks and Accessories                              | 63  |
| BEST Preferred Patented Keys                       | 16 | 45HZ Keypad EZ Mortise Locks                                       | 65  |
| BEST CORMAX Patented Keys                          | 17 | 9KZ Keypad EZ Cylindrical Locks                                    | 66  |
| B Series Padlocks                                  | 18 | EXZ Keypad EX Exit Trim  | 67  |
| BEST Standard & Premium Cores                      | 20 | 45HG Offline G Series Mortise Locks                                | 68  |
| BEST Peaks Cores                                   | 21 | 9KG Offline G Series Cylindrical Locks                             | 69  |
| BEST Preferred Patented Cores                      | 22 | EXG Offline G Series Exit Trim                                     | 70  |
| BEST CORMAX Patented Cores                         | 23 | 45HBV Offline V Series Mortise Locks                               | 71  |
| D Series Service Equipment                         | 24 | 9KBV Offline V Series Cylindrical Locks                            | 72  |
| KRD Series Key Retaining Devices                   | 26 | EXBV Offline V Series Exit Trim                                    | 74  |
| QU-I C-SYSTEM Combining Tool Packages              | 27 | 45HM IDH MAX Mortise Locks   | 75  |
| E Series Cylinders                                 | 28 | 9KM IDH MAX Cylindrical Locks                                      | 77  |
| 5E and 8E Series Utility Cylinders (Cam Locks)     | 30 | Wi-Q Technology Wireless Access Management Software & Accessories  | 78  |
| Keystone Web                                       | 31 | BEST 45HQ Wireless Mortise Locks with Wi-Q Technology              | 79  |
| 45H Series Mortise Components                      | 32 | BEST 9KQ Wireless Cylindrical Locks with Wi-Q Technology           | 81  |
| 47H Series High Security Mortise Lock              | 34 | BEST EXQ Wireless Exit Trim with Wi-Q Technology                   | 82  |
| 48H and 49H Series Mortise Deadlocks               | 35 | BEST Wireless Conversion Kits with Wi-Q Technology                 | 83  |
| 40H Series Mortise Components                      | 36 | STANLEY ID Express Station   | 84  |
| 40H Strike Packages                                | 37 | Electronic Lock Inside Escutcheon Conversion Kits                  | 85  |
| 40H Replacement Spindles                           | 38 | 45HOM Omnilock Wireless Mortise Locks                              | 86  |
| 40H Faceplate Kits                                 | 38 | 9KOM Omnilock Wireless Cylindrical Locks                           | 87  |
| 40H Visual Indicator                               | 39 | OMEM Omnilock Electric Modules                                     | 88  |
| J Series Semi-Trailer Kingpin Locks                | 40 | OMWMS Omnilock Wall Mount Systems                                  | 89  |
| 6K Series Grade 2 Cylindrical Locks - Knobs        | 41 | QASOM Quick Adapter for Pre-2004 Cylindrical Schlage D Lever Locks | 90  |
| 7K Series Grade 2 Cylindrical Locks - Levers       | 42 | QAXOM Omnilock Wireless Quick Adapter for Exit Devices             | 91  |
| 8K Series Grade 1 Cylindrical Locks - Knobs        | 43 | Access Control System Parts and Accessories                        | 92  |
| 9K Series Grade 1 Cylindrical Locks - Levers       | 45 | Non-BEST Chassis for OMEM  | 93  |
| AK Series Knob Adaptions                           | 47 | OMNILOCK Software  | 94  |
| L Series Cabinet Locks                             | 48 | Quoting & Ordering Policies  | 95  |
| P Series Push Locks                                | 49 | Return Policy and Fulfillment Issues                               | 98  |
| S Series Sliding Door Locks                        | 50 | Forms  | 100 |
| SPSL - Secure Patient Safety Lever                 | 51 |  |     |
| SSRL - Secure Seclusion Room / Time Out Room Locks | 53 |  |     |
| SEDA - Secure Emergency Door Alarm                 | 54 |  |     |
| T Series Tubular Deadbolts                         | 55 |  |     |
| 9KX SHELTER Cylindrical Locks                      | 56 |  |     |



## TERMS AND CONDITIONS OF SALE

The terms and conditions contained herein shall govern the sale of all products located in the price catalog and/or offered for sale by dormakaba USA Inc. ("dormakaba USA"), except for those products as set forth under separate Value Added Reseller Agreements. The acceptance of any order is expressly made conditional upon your assent to these Terms and Conditions of Sale.

**PRICES:** dormakaba USA reserves the right, in its sole discretion, to change or amend its price list (including, but not limited to, adding or removing Products from the price list), and standard terms and conditions of sale as contained in its catalogs, price list or published sales policies, without incurring any liability whatsoever to its Customer or others. All orders will be filled at the List Price in effect at the time of order placement. All prices are subject to change without notice and are not guaranteed.

**TAXES:** List prices do not include federal, state or local taxes.

**ORDERS:** No order for Products shall be deemed to have been accepted by dormakaba USA until written notice of its acceptance is received by the Customer from dormakaba USA via an order acknowledgement. dormakaba USA reserves the right, in its sole discretion, to decline to accept any order. Purchase Orders will bind dormakaba USA only to the extent accepted by dormakaba USA's written confirmation or delivery.

dormakaba USA will attempt to fill orders in the order in which they are received, subject to prior orders. However, dormakaba USA reserves the right to allocate orders or fill an order or orders ahead of prior orders, if, in its judgment, the facts warrant such a change.

Any additional provisions in a Purchase Order, including any pre-printed terms, shall be void and not binding on dormakaba USA, unless expressly accepted by dormakaba USA. For greater certainty, the acceptance by dormakaba USA of a Purchase Order shall not be deemed acceptance of the additional terms of such Purchase Order.

dormakaba USA will accept orders via phone, email, fax or courier. dormakaba USA will send out an order acknowledgement for all orders received via email, phone or fax.

NOTE: Receipt or possession of this price catalog does not grant approval to quote or purchase products. Please contact your dormakaba USA Sales Representative for further details.

**KEYING SYSTEM ORDERS:** All orders of keying systems specifying delayed fulfillment must be fulfilled within twelve (12) months of the order date. Said request for fulfillment must include complete keying instructions for the order to be acknowledged with an estimated delivery date. Failure to properly request fulfillment of the order within twelve (12) months of the order date will make the order void and nonrefundable.

**SPECIAL ORDERS:** Any modification to a standard product configuration is considered a special order. No credits will be issued for returned special orders unless authorized by dormakaba USA Customer Service.

**INCOMPLETE ORDERS:** An incomplete order is one that is not fully specified according to the appropriate nomenclature required for that product. Any incomplete order will not be entered and will be referred to the appropriate dormakaba USA Sales Representative for resolution.

**SAMPLES:** Please contact your local dormakaba USA Sales Representative for sample requests.

**MINIMUM CHARGE:** The expense of handling an order necessitates a minimum charge of \$50.00 net per invoice.

**CREDIT LIMITS:** dormakaba USA's policy is to extend Net 30-day terms/open account combined with a credit line based on financial capacity. For all accounts dormakaba USA requires a Credit Application and Sales Tax Exempt Certificate (if applicable). dormakaba USA evaluates traditional sources of credit information: D&B, trade and bank references, financial information, and business plans. The supply of credit herein shall be at the discretion of dormakaba USA. If available information and/or financial circumstances will not support open accounts terms, dormakaba USA offers Cash in Advance and Credit Card (MasterCard or VISA) terms. dormakaba USA performs periodic reviews of credit lines and terms of payment and may request updated financial information.

dormakaba USA reserves the right to withhold delivery of Product if Customer does not meet dormakaba USA's credit requirements for the amount of Product ordered, or the amount of Product which remains unpaid (whether or not overdue) exceeds the limit established by dormakaba USA for Customer. Customer shall provide, at dormakaba USA's request, an acceptable letter of credit or guarantee or security in a form and amount determined by dormakaba USA.

If Customer shall become overdue on its account or otherwise defaults in any payment to dormakaba USA or if its financial condition shall at any time appear inadequate to warranty further shipment on an open account basis, dormakaba USA shall have the right, without liability, to refuse to accept any or all orders, to cancel any and all orders, to delay shipments, or to require advance payment before accepting or shipping any orders. All orders and all shipments are subject to approval by the dormakaba USA Credit Department.

**PAYMENT TERMS:** dormakaba USA standard payment terms are 2% 15, net 30 days from date of invoice.

Effective September 28, 2014, a \$45.00 convenience fee will apply to all payments made by Credit Card towards open invoices on your account. You may choose to pay by credit card by reaching out to your Credit Analyst directly in order to process payment. You can avoid paying the \$45.00 convenience fee by enrolling and paying open invoices via Billtrust Invoice Gateway (<https://secure.billtrust.com/stanleymechanical/ig/signin>) with an ACH Payment (bank transfer from checking or savings account) free of charge. Payments by check, or money order should continue to be sent directly to the remit-to address noted on invoices.

dormakaba USA shall be entitled to charge and Customer shall pay interest on overdue invoices at the rate of two percent (2%) per month calculated from the date of the invoice to the date of payment, including any attorney fees incurred by dormakaba USA resulting from the collection of such overdue payment. Customer shall pay all sums owing to dormakaba USA without any deduction or abatement and Customer shall have no right of set-off.

In the event that Customer disputes any portion of the payment due, Customer shall be obligated to pay the balance which is not the subject of dispute.

Without limiting any other rights it may have under these terms of sale and applicable law, all of dormakaba USA's obligations under this Agreement, including obligations of supply, or any Purchase Order, can be suspended or cancelled should Customer be delinquent in making payment for previously shipped Products.

### INTERNATIONAL SALES:

International Resellers located outside of the United States of America who place orders are subject to and must pay by (1) Cash in Advance, (2) Confirmed Irrevocable Letter of Credit, (3) Standby Letter of Credit.

All international shipments shall be FCA (Incoterms 2010) from dormakaba USA's facility in Indianapolis, Indiana USA. dormakaba USA shall be deemed to have delivered all Products and related goods when such are put in the custody of a carrier at dormakaba USA's plant or warehouse above, at which time all title and risk of loss or damage shall pass to Customer.

May 2018



## TERMS AND CONDITIONS OF SALE (continued)

**SHIPPING/FREIGHT:** All Products shall be shipped FOB Origin domestic or FCA International (INCOTERMS 2010) from dormakaba USA's facility in Indianapolis, Indiana USA. dormakaba USA shall be deemed to have delivered all Products and related goods when such are put in the custody of a carrier at dormakaba USA's plant or warehouse above, at which time all title, risk of loss or damage shall pass to Customer. All shipments will be made in accordance with the preferred routing, carrier assignments, and operational guidelines of dormakaba USA. Customer shall bear all costs of freight, insurance and associated costs and shall make all arrangements for same.

Single or combined shipments including dormakaba USA lock sets, exit devices, hinges and door closers will be considered for free freight with orders at or above \$5000 net (product combination must be on same purchase order). Orders less than \$5,000 will be shipped freight prepaid with shipping cost added to the invoice, including a nominal freight charge to be determined by dormakaba USA at time of shipping.

Hinge only orders will be considered for free freight with orders at or above \$750 net. Orders less than \$750 will be shipped freight prepaid with shipping cost added to the invoice, including a nominal freight charge to be determined by dormakaba USA at time of shipping.

These freight terms apply only to a single destination within the contiguous United States.

Should a shipment qualify for one of dormakaba USA's free freight programs, the Products shall be shipped FOB Origin domestic (with exception to prepaid freight) or FCA International (INCOTERMS 2010) (with exception to prepaid freight) from dormakaba USA's facility in Indianapolis, Indiana USA.

**DELIVERY:** Orders shall be acknowledged and given a scheduled delivery date based on estimated manufacturing lead times. Manufacturing lead time will begin once all information is received to process an order. Delivery dates given by dormakaba USA as part of order acknowledgment for accepted orders for Products or related goods will be honored by dormakaba USA on a best effort basis. Shipping dates shown on order acknowledgments are based upon dormakaba USA's estimate and cannot be guaranteed. dormakaba USA will not be liable for any loss or damage resulting from delay in filling orders, including any direct or consequential loss or damage. dormakaba USA reserves the right to make partial shipments unless the order specifies otherwise.

**CHANGES/CANCELLATIONS:** After orders are entered for manufacturing, changes or cancellations cannot be accepted without dormakaba USA written permission, and may be subject to a change or cancellation charge equivalent to 30% of the purchase price.

Orders for special and/or custom designed goods not immediately saleable to another customer are not changeable, cancelable, or returnable.

**RETURNED GOODS:** dormakaba USA Customer Service MUST authorize all returns. All goods must be returned in original packaging and be in resalable condition except for warranty returns. Use fax number 888-214-1918 for returned goods authorization only. Only goods with an invoice date of less than one (1) year will be considered for a Return Goods Authorization (RGA). All material returned to dormakaba USA, regardless of the reason, must have a correct RGA number applied to the outside of the shipping carton. A restocking charge of 30% of the purchase price will be applied to the Customer's account except for warranty returns. Transportation charges of returned goods must be prepaid by Customer. All goods must be returned within sixty (60) calendar days of RGA issue date. All goods must be returned in original packaging and be in resalable condition except for warranty returns. Product not returned in salable condition or after sixty (60) days of the RGA issue date is subject to disposal by dormakaba USA with no credit issued.

dormakaba USA cannot authorize the return of discontinued product. Under no circumstances will special order items be accepted for return, unless covered by warranty.

**EXPORT REGULATIONS:** Customer agrees to conform to, and abide by, the export laws and regulations of the US, including, but not limited to, the Export Administration Act of 1979 as amended and its implementing regulations. Diversion contrary to US laws and regulations is prohibited.

**MASTERKEYING:** Best Masterkey Code and Masterkey Service Policy can be found at [www.bestaccess.com](http://www.bestaccess.com).

**LIMITATION OF LIABILITY:** EXCEPT AS OTHERWISE REQUIRED BY APPLICABLE LAW, dormakaba USA SHALL HAVE NO LIABILITY FOR ANY CONSEQUENTIAL, SPECIAL, INCIDENTAL, INDIRECT, EXEMPLARY, LIQUIDATED OR PUNITIVE DAMAGES, INCLUDING, WITHOUT LIMITATION, LOST PROFITS, COSTS OF DELAY, ANY FAILURE OF DELIVERY, OR BUSINESS INTERRUPTION, REGARDLESS OF WHETHER THE CLAIM GIVING RISE TO SUCH DAMAGES IS BASED UPON BREACH OF WARRANTY, BREACH OF CONTRACT, TORT (INCLUDING NEGLIGENCE OR STRICT LIABILITY), PRODUCT LIABILITY, OR OTHERWISE, EVEN IF dormakaba USA HAS BEEN ADVISED OF THE POSSIBILITY THEREOF. TO THE MAXIMUM EXTENT PERMITTED BY APPLICABLE LAW, IN NO EVENT WILL dormakaba USA'S TOTAL AGGREGATE LIABILITY TO CUSTOMER, UNDER ANY LEGAL THEORY, WHETHER IN CONTRACT, TORT (INCLUDING NEGLIGENCE OR STRICT LIABILITY), PRODUCT LIABILITY, INFRINGEMENT OF OR DAMAGE TO ANY PATENT, COPYRIGHT, TRADEMARK, OR OTHER INTELLECTUAL PROPERTY RIGHTS OF ANY PERSON OR ENTITY, OR OTHERWISE IN RELATION TO THE SALE OF dormakaba USA PRODUCTS TO CUSTOMER, EXCEED THE AGGREGATE OF THE AMOUNT PAID OR PAYABLE TO dormakaba USA BY CUSTOMER FOR THE ORDER GIVING RISE TO THE ALLEGED LIABILITY.

**LIMITED WARRANTY:** The terms and conditions outlined above are subject to dormakaba USA's Limited Warranty, which is included in the Price Catalog and is incorporated herein by reference. Upon return of a defective product, dormakaba USA shall either repair or replace the product, in its sole discretion, in accordance with our standard warranty.

EXCEPT AS SET FORTH HEREIN, dormakaba USA MAKES NO WARRANTIES, EXPRESSED OR IMPLIED, AND BUYER ACKNOWLEDGES THAT NO REPRESENTATIONS, WARRANTIES, PROMISES OR STATEMENTS HAVE BEEN MADE BY dormakaba USA, WITH RESPECT TO THIS PRODUCT, OR ANY PART OR PORTION THEREOF. IN ADDITION, dormakaba USA MAKES NO WARRANTY OF MERCHANTABILITY OR FITNESS FOR A PARTICULAR PURPOSE OF THIS PRODUCT OR ANY PART OR PORTION THEREOF, FOR ANY PURPOSE, NOR ANY WARRANTY WHICH EXTENDS BEYOND THE DESCRIPTION ON THE FACE HEREOF. dormakaba USA SHALL NOT, IN ANY EVENT, BE LIABLE FOR ANY CONSEQUENTIAL OR INCIDENTAL DAMAGES SUFFERED BY BUYER OR ANYONE CLAIMING BY, THROUGH OR UNDER BUYER, AS A RESULT OF THE CONDITION OF THIS PRODUCT, OR ANY PART OR PORTION THEREOF, AND THERE ARE NO ORAL OR WRITTEN UNDERTAKINGS OR AGREEMENTS OF ANY TYPE PROVIDED BY dormakaba USA EXCEPT AS EXPRESSLY SET FORTH HEREIN. SOME STATES DO NOT ALLOW LIMITATIONS ON HOW LONG AN IMPLIED WARRANTY LASTS OR PROHIBIT THE EXCLUSION OR LIMITATION OF INCIDENTAL OR CONSEQUENTIAL DAMAGES, SO THE ABOVE LIMITATION AND EXCLUSIONS MAY NOT APPLY IN YOUR STATE.

**GOVERNING LAW:** These Terms and Conditions of Sale and any subsequent sales agreements between dormakaba USA and Customer shall be construed in accordance with the laws of the State of Indiana. The United Nations Convention on Contracts for the International Sale of Goods shall not apply to this Agreement.

May 2018



## LIMITED WARRANTY

**What is Covered:** dormakaba USA Inc. ("dormakaba USA") warrants that the products manufactured by dormakaba USA, identified below, and sold under its trade names "BEST" are free of defects in materials and workmanship as outlined below. The sole and exclusive liability of dormakaba USA under this warranty is limited to the repair or replacement of any Product or component part covered by the warranty at the sole discretion of dormakaba USA.

**Who is Covered:** This warranty is extended only to the Seller's distributors of products and the end user who purchases Products for purposes other than resale (collectively, "Purchaser").

### **Hardware Warranty Period:**

The following products warranty term shall be limited lifetime for a period of the useful life of the building in which the product is originally installed:

- 45H/47H Mechanical Mortise Lock
- 48H/49H Mortise Deadlock
- BML83 Series Electronic Strikes and Mags

The following products shall be warranted for ten (10) years from the date of sale:

- 9K Mechanical Cylindrical Lock

The following products shall be warranted for five (5) years from the date of sale:

- 45HW and 47HW Electromechanical Mortise Lock
- BES 2 Series Electronic Strikes and Mags
- BES 0162 Series Electronic Strikes and Mags
- BES 0563 Series Electronic Strikes and Mags

The following products shall be warranted for three (3) years from the date of sale:

- 8K Mechanical Cylindrical Lock
- 8K/9K Electro-mechanical Cylindrical Lock
- 9KZ Keypad EZ Cylindrical Lock
- 9KM IDH Max Cylindrical Lock
- 5K, 6K, and 7KC Cylindrical Locks
- 8T/7T Tubular Locks
- 1E, 5E, 8E Cylinders Locks
- 45HZ Keypad EZ Mortise Lock
- EXZ Keypad
- 45HM IDH Max Mortise Lock
- 1C, 2C, 3C, 5C, 6C Cores
- 1A Keys
- 1AM, 1AX Keys (CORMAX)
- AD433 Key Combinator & Equipment
- 11B, 21B, 41B family Padlocks
- 1W Switch Locks
- S Sliding Door Locks
- 45HG, 9KG, 45HBV, 9KBV Offline Locks
- 45HN, 9KN Electrified Locks
- 45HQ, 9KQ and EXQ locks using Wi-Q(tm) Technology
- AK Series Knob Adaptations
- 5L, 3L, 2P Cabinet Locks
- SP5L, SSRL, SEDA Secure Patient Safety Lever, Seclusion Room Locks, Emergency Door Alarms
- BES 4 Series Electronic Strikes and Mags
- BES 6 Series Electronic Strikes and Mags

The following products shall be warranted for one (1) year from the date of sale:

- 45HOM, 9KOM, OMEM, OMWMS, QASOM, QAXOM, Portal Gateways, Wireless Access Controllers, Antennas and other products using Wi-Q(tm) Technology not specifically mentioned
- 1CB, 1CK, 1AF Kaba Cores & Keys
- Portal Gateways, Wireless Access Controllers, Antennas and other products using Wi-Q™ Technology not specifically mentioned
- BMLDE Series Electronic Strikes and Mags built-in sounder components

May 2018





## LIMITED WARRANTY (continued)

Finishes shall be warranted for three (3) years from the date of sale excluding US10B/613 "Oil Rubbed Bronze" finish.

### **Wi-Q™ Technology and Offline Software:**

- dormakaba USA warrants that all software shall be free from defects in materials and workmanship and will function in substantial accordance to the specifications for a period of one (1) year from the date of installation.
- Specific Limitations: This warranty does not cover any post-sales technical support under the following circumstances:
  - Problems caused by misuse of software or hardware
  - Failure to provide a network connection or site phone line for a modem connection, if deemed necessary by dormakaba USA
  - Technical support for network software products
  - Technical support for software installed on computer hardware or computer operating system that is no longer commercially available for purchase.

**Warranty Claims:** Any Products believed to be defective as covered by this warranty may not be returned without prior written Returned Materials Authorization (RMA) from dormakaba USA Product Support (855) 365-2407 covering specific items and quantities within thirty (30) days from the discovery of the alleged defect(s). dormakaba USA will inform the purchaser where to ship said Product(s), shipping charges prepaid by you, for examination. In the event such examination reveals a defect covered by this warranty; dormakaba USA will, at its sole option, repair or replace the Product, and return it or its replacement to the purchaser, with charges only for shipping.

**Exclusions:** This warranty specifically excludes, and dormakaba USA shall not be held responsible for the following:

- a) **COSTS ASSOCIATED WITH INSTALLING, REMOVING OR REINSTALLATION OF THE PRODUCT.**
- b) Damage caused by Product malfunction or failure attributable to acts of God.
- c) Improper use or installation.
- d) Poor or no maintenance.
- e) Work performed by someone other than an Authorized dormakaba USA technician.
- f) Failure to follow dormakaba USA's operating instructions or environmental specifications.
- g) Incorrect application, modification, vandalism, erosion or corrosion, shipping and/or handling, improper storage, accident, misuse, abuse or any other cause not within the control of dormakaba USA.
- h) This warranty is void if any modification is made to the warranted product, regardless of whether the modification causes or contributes to the alleged defect. All modifications are made at the risk and expense of the party making the modifications.
- i) dormakaba USA shall not be liable for any repairs, replacements, or adjustments to the product or any costs of labor performed by the Purchaser or others without dormakaba USA's prior written approval.
- j) dormakaba USA provides no warranty or guarantee that its cores and/or cylinders will function properly or be mechanically compatible with products not manufactured by dormakaba USA.
- k) The US10B/613 finish is considered to be a living finish that will change over time with use and age and is expressly excluded from this warranty. The finish changes that occur are indicative of normal wear and tear and reflect the essence of a living finish. The finish changes are not considered manufacturing defects and are not covered by this warranty.

**Third Party Warranty:** Except as otherwise provided above, dormakaba USA makes no warranty, express or implied, with regard to third party hardware or software and expressly disclaims the implied warranties or conditions of merchantability or merchantable quality, fitness for a particular purpose, title, infringement and those arising by statute or otherwise in law. Customer's sole recourse for warranty claims is with the manufacturer of the Product. However, dormakaba USA agrees to pass through any third-party warranty that dormakaba USA receives from the manufacturer of the Products to Purchaser. The extent of any third-party warranty details, terms and conditions, remedies and procedures may be expressly stated on, or packaged with, or otherwise accompanying the Products.

**LIMITATION OF WARRANTIES: THIS WARRANTY IS GIVEN EXPRESSLY AND IN PLACE OF ALL OTHER WARRANTIES, EXPRESS OR IMPLIED, INCLUDING ANY IMPLIED WARRANTIES OF MERCHANTABILITY OR FITNESS FOR PARTICULAR PURPOSE. THERE ARE NO UNDERSTANDINGS, AGREEMENTS, REPRESENTATIONS, OR WARRANTIES NOT SPECIFIED HEREIN.**

dormakaba USA SHALL NOT, IN ANY EVENT, BE LIABLE FOR ANY CONSEQUENTIAL, INCIDENTAL, INDIRECT, SPECIAL OR PUNITIVE DAMAGES SUFFERED BY PURCHASER OR ANYONE CLAIMING BY, THROUGH OR UNDER PURCHASER, AS A RESULT OF THE CONDITION OF THIS PRODUCT, OR ANY PART OR PORTION THEREOF.

SOME STATES DO NOT ALLOW LIMITATIONS ON HOW LONG AN IMPLIED WARRANTY LASTS OR PROHIBIT THE EXCLUSION OR LIMITATION OF INCIDENTAL OR CONSEQUENTIAL DAMAGES, SO THE ABOVE LIMITATION AND EXCLUSIONS MAY NOT APPLY IN YOUR STATE.

THIS WARRANTY IS GOVERNED BY THE LAW OF THE STATE OF INDIANA WITHOUT REGARD TO ITS CONFLICTS OF LAW PRINCIPLES. dormakaba USA AND PURCHASER AGREE THAT THE UNITED NATIONS CONVENTION ON CONTRACTS FOR THE INTERNATIONAL SALE OF GOODS SHALL NOT APPLY TO SALE OF THE PRODUCTS COVERED BY THIS WARRANTY.

FOR WARRANTY ON THE SHELTER 9KX PRODUCTS AND ACCESSORIES, PLEASE SEE SEPARATE SHELTER 9KX SERIES PRODUCT AND ACCESSORIES WARRANTY AT [WWW.BESTSHELTERLOCKDOWN.COM](http://WWW.BESTSHELTERLOCKDOWN.COM)

May 2018





## BEST PATENTED PRODUCT ORDERING & LICENSE

**SALE OF BEST PATENTED PRODUCT:** In accordance with the [dormakaba USA Inc. \("dormakaba USA"\) Masterkey Code and Masterkey Service Policy](#), only Authorized Distributors meeting certain necessary qualifications and standards shall be selected by dormakaba USA to sell Best Patented Product. Selection shall be at the sole discretion of dormakaba USA and shall be evidenced in writing via the Distributor Agreement or its select addendums.

**STOCKING OF BEST PATENTED PRODUCT:** Furthermore, dormakaba USA may authorize only select Authorized Distributors to purchase and stock Best Patented Product and have access to Best Patented Masterkey Codes by entering into a [Best Patented Masterkey System Distributor Agreement Addendum](#) (the "Authorized Stocking Distributor"). As a condition to the Authorized Stocking Distributor's continued access to Best Patented Masterkey Codes, it must comply at all times with the [Best Patented Key Systems Security Procedure](#).

**SECURITY AUTHORIZATION FORM:** It is a responsibility of the Authorized Distributor to ensure that Best Patented Product does not end up in the possession of unauthorized individuals or entities. The Authorized Distributor must ensure that the End User completes a Best Patented Masterkey System Security Authorization Form (the "[Security Authorization Form](#)"). The [Security Authorization Form](#) designates those individuals within the End User's organization that are authorized to place orders with the Authorized Distributor for Best Patented Product. The [Security Authorization Form](#) must be completed and signed by the End User.

It is the Authorized Distributor's full responsibility to validate the End User's signature as identified on the [Security Authorization Form](#) prior to accepting any orders for Best Patented Product.

In certain circumstances the Authorized Distributor selling and/or stocking the Best Patented Product will not contract directly with the End User. In these circumstances, the Authorized Distributor is required to work with its reseller to ultimately ensure that the End User submits a signed [Security Authorization Form](#) to dormakaba USA.

For those Distributors who have been authorized by dormakaba USA to stock Best Patented Product, it is their responsibility to ensure that they have a completed [Security Authorization Form](#) on file for each End User that places an order with the Authorized Stocking Distributor for Best Patented product and that the Authorized Stocking Distributor authenticates the signature of each Best Patented Product order utilizing the [Security Authorization Form](#).

dormakaba USA shall have the right to audit all [Security Authorization Forms](#) maintained by the Authorized Distributors for completeness, accuracy and compliance with this Policy.

### **BEST CORMAX™ PATENTED KEYING SYSTEM-PATENT LICENSE:**

1. The Best Cormax keying system being offered for sale under this price catalog is protected by valid and enforceable patents issued by the United States Patent and Trademark Office pursuant to United States Federal Law (including U.S. Patent Nos. 7,681,425 and 5,615,566 (also designated as US RE 39,364) (collectively, the "Best Patents"). The rights to the Best Patents belong to dormakaba USA Inc. ("dormakaba USA"). The Best Cormax keying system is comprised of two main components, a core and one or more keys. The combination of the Best Cormax core and key(s) is protected by the Best Patents. The Best Cormax keys, key blanks, and cores contain registered trademarks belonging to dormakaba USA. **dormakaba USA considers its patent and trademark rights to be valuable intellectual property assets that are important in protecting security and maintaining key control of its products. Accordingly, it is in dormakaba USA's best interest and, more importantly, it is in the best interest of its end users, that the Best Cormax system be managed in a manner that guards against unauthorized key duplication, which compromises the security of the Best Cormax system.** As a condition of purchase of a Best Cormax system from dormakaba USA or one of its authorized distributors, the following limitations on the express and implied contractual and intellectual property rights with respect to the Best Cormax system and the Best Patents shall apply:

- a. All Best Cormax systems shall be sold with a limited license to practice the Best Patents by combining and using (i) the Best Cormax core that is purchased with the Best Cormax system with (ii) the Best Cormax key(s) and/or key blanks(s) that are purchased with the Best Cormax system.
- b. This license is conditioned upon the purchase of a Best Cormax core and key (or core and key blank) combination only from dormakaba USA or one of its authorized distributors. Only dormakaba USA and its authorized distributors are authorized to sell the core and key(s)/blank(s) that comprise the Best Cormax system. All other sales of those items, individually or together, including either finished Best Cormax keys or unfinished key blanks suitable for finishing into Best Cormax keys, by any party other than dormakaba USA or one of its authorized distributors, for purposes of making the patented core and key combination, are not authorized sales and are excluded from this license.
- c. In the event that an end user sells a Best Cormax core, either standing alone or in connection with a sale of the structure or building in which it is installed, to a third party, the end user shall be required to notify the third-party purchaser of the terms and conditions and limitations of this license, which equally apply to the third party purchaser.
- d. dormakaba USA does not grant under the license, the right to sell any Best Cormax keys or key blanks to a third party, except in

May 2018



## BEST PATENTED PRODUCT ORDERING & LICENSE (continued)

connection with a sale of the corresponding Best Cormax core in a manner that complies with the terms, conditions, and limitations of this license.

**e.** Best Cormax keys and/or key blanks will be shipped by dormakaba USA or one of its authorized distributors directly and only to employees, as designated in the Security Authorization Form.

**f.** In order to maintain the integrity of the Best Cormax system, the Best Cormax key or key blank should not be altered at any time to operate any core/cylinder for which such key or key blank was not originally intended.

**g.** In the event that any of the procedures outlined herein are not strictly followed with respect to the handling of Best Cormax keys and key blanks, dormakaba USA may require following good faith discussions, the prompt return via UPS/AOD or equivalent, of all Best Cormax keys and/or blanks. Those items, in like new condition, shall be repurchased by dormakaba USA at the original sale price less a restocking fee.

**h.** Should any terms of this license be found to be invalid, by operation of law or otherwise, all other provisions herein shall remain in full force and effect.

May 2018



## BEST MASTERKEY CODE AND MASTERKEY SERVICE POLICY

### I. DISTRIBUTOR MASTERKEY SERVICES

All dormakaba USA Inc. ("dormakaba USA") Authorized Distributors, Aftermarket Wholesalers, and Locksmiths ("Authorized Distributors") can create, modify or extend masterkey codes for the benefit of their end user customers ("End Users") for Best non-patented masterkey systems; provided, however, the services must be performed in line with industry standards. With the express written permission of dormakaba USA, select Authorized Distributors can create, modify or extend masterkey codes for the benefit of End Users for a Best Patented Masterkey System (pursuant to the terms and conditions of Section C below). Authorized Distributor's failure to comply with the terms of this policy could result in dormakaba USA's termination of its Distributor Agreement as well as dormakaba USA's pursuit of any remedies available at law.

#### A. END USER INFORMATION AND CODE RELEASE:

All masterkey codes (both patented and non-patented) previously generated by dormakaba USA are available for distribution to End Users (and/or their designated Authorized Distributor, if applicable) via the End User Web Portal at <http://masterkeycodeportal.bestaccess.com/Login.aspx>. For a hard copy of the End User Information and Code Release Form, please contact your dormakaba USA End User Consultant. End user codes will be distributed solely to those Authorized Distributors (a) identified by the End User on a fully executed End User Information and Code Release Form received by Best, and (b) for the release of Best Patented Masterkey Codes, the Authorized Distributor is authorized by dormakaba USA to receive and process Best Patented Masterkey Codes (as more fully described in Section C below.) No exceptions will be made to this policy.

#### B. BEST NON-PATENTED MASTERKEY SYSTEM

As of September 4, 2012, dormakaba USA no longer requires a Security Authorization Form to be signed by the End User prior to dormakaba USA and/or its Authorized Distributor accepting core and key orders for non-patented keying systems. All valid End User communications for orders related to non-patented keying systems will be fulfilled at the End User's liability.

#### C. BEST PATENTED MASTERKEY SYSTEM

The Best Patented Masterkey System provides a higher level of protection against unauthorized key duplication and crossovers and, in order to maintain the quality of a Best Patented Masterkey System, the following terms and conditions of this policy shall apply to any and all Authorized Distributors with access to Best Patented Masterkey Systems. For the purpose of this policy, "Best Patented Product" shall mean the Best Cormax (including cores and keys), as well as any and all future product dormakaba USA designates as patented product for the purpose of this policy. "Best Patented Masterkey Systems" and "Best Patented Masterkey Codes" shall mean the respective masterkey system or codes of any Best Patented Masterkey Product.

**Sale of Best Patented Product:** As further described in this Section C, only those Authorized Distributors meeting certain necessary qualifications and standards shall be selected by dormakaba USA to sell Best Patented Product. Selection shall be at the sole discretion of dormakaba USA and shall be evidenced

in writing via the Distributor Agreement or its select addendums.

**Best Patented Security Authorization Form:** It is a responsibility of the Authorized Distributor to ensure that Best Patented Product does not end up in the possession of unauthorized individuals or entities. The Authorized Distributor must ensure that the End User completes a Best Patented Masterkey System Security Authorization Form (the "Security Authorization Form") as outlined in this Section C. The Security Authorization Form designates those individuals within the End User's organization that are authorized to place orders with the Authorized Distributor for Best Patented Product. The Security Authorization Form must be completed and signed by the End User.

It is the Authorized Distributor's full responsibility to validate the End User's signature as identified on the Security Authorization Form prior to accepting any orders for Best Patented Product.

In certain circumstances the Authorized Distributor selling the Best Patented Product will not contract directly with the End User. In these circumstances, the Authorized Distributor is required to work with its reseller to ultimately ensure that the End User submits a signed Security Authorization Form to dormakaba USA.

dormakaba USA shall have the right to audit all Security Authorization Forms maintained by the Authorized Distributors for completeness, accuracy and compliance with this Policy.

#### Sale of Combined Best Patented Product through

**Distributor:** dormakaba USA may authorize select Authorized Distributor to purchase and resell to an End User Best Patented Product that has been combined by dormakaba USA Personnel. In this instance, a Security Authorization Form must be completed and signed by the End User and provided by the Authorized Distributor to dormakaba USA with each Best Patented Product order.

#### Stocking of Best Patented Product:

dormakaba USA may authorize select Authorized Distributors to purchase and stock Best Patented Product and have access to Best Patented Masterkey Codes by entering into a Best Patented Masterkey System Distributor Agreement Addendum (the "Authorized Stocking Distributor") As a condition to the Authorized Stocking Distributor's continued access to Best Patented Masterkey Codes, it must comply at all times with the Best Patented Key Systems Security Procedure. In addition, it is the responsibility of the Authorized Stocking Distributor to ensure that they have a completed Security Authorization Form on file for each End User that places an order with the Authorized Stocking Distributor for Best Patented product and that the Authorized Stocking Distributor authenticates the signature of each Best Patented Product order utilizing the Security Authorization Form.

May 2018



## STANLEY MASTERKEY CODE AND MASTERKEY SERVICE POLICY (continued)

**Best Patented Masterkey Code Generation:** To assist in reducing the possibility of duplication within a keying system and ensure security, all Best Patented Masterkey Codes must be created, modified and/or extended by Best's masterkey personnel and/or an Authorized Stocking Distributor. The unauthorized duplication or release of Best Patented Masterkey Codes to non-authorized people or organizations, including, but not limited to, unauthorized distributors, wholesalers, private locksmiths, other lock manufacturers, architects, or contractors, is a violation of this policy as well as the infringement of patent rights and other intellectual property rights of dormakaba USA. In addition to any other recourse available under law, the unauthorized release of Best Patented Masterkey Codes by any Authorized Stocking Distributor shall result in immediate termination.

**Best Patented Masterkey System Exclusive Keyways:** Upon request from an End User to release Best Patented Masterkey Codes previously generated by dormakaba USA that are on an exclusive keyway, dormakaba USA will send a notification to the End User reminding them that their patented codes are on an exclusive keyway. dormakaba USA will provide a copy of this notice to the Authorized Stocking Distributor. To assist in reducing the possibility of duplication within an End User exclusive keying system and ensure security, all exclusive Best Patented Masterkey Codes must be created, modified and/or extended and recorded in dormakaba USA's BESTCode masterkey code management tool.

Should dormakaba USA approve an Authorized Stocking Distributor to establish a Best Patented Masterkey System on an exclusive keyway, the Authorized Stocking Distributor shall be required to sign a Best Patented Masterkey System Exclusive Keyway Addendum. To assist in reducing the possibility of duplication within a Distributor exclusive keying system and ensure security, all exclusive Best Patented Masterkey Codes must be created, modified and/or extended and recorded in dormakaba USA's BESTCode masterkey code management tool.

**Copies of Best Patented Masterkey Codes:** dormakaba USA shall have a right to a copy of all Best Patented Masterkey Codes that have been originated, modified, extended or otherwise maintained by the Authorized Stocking Distributor in the dormakaba USA BESTCode system in order for dormakaba USA to be able to provide continued support either directly, or indirectly, to the End User.

### II. BEST MASTERKEY SERVICES

**A. BEST MASTERKEY SERVICES PROVIDED TO DISTRIBUTOR:** dormakaba USA, upon request and at its sole discretion, may provide select masterkey services to an Authorized Distributor for both non-patented masterkey systems and Best Patented Masterkey Systems. In order for an Authorized Distributor to place an order for the extension of, or modification to, a masterkey system previously created or maintained by dormakaba USA, the

End User must have selected that Authorized Distributor as its authorized designee in the End User Information & Code Release Form received by dormakaba USA. Complete keying instructions must be given before a Best order can be properly acknowledged with an estimated delivery date. dormakaba USA reserves the right to charge for the service of a customized masterkey security solution with the purchase of a Best product. A masterkey service charge will be assessed for each order for cylinders or cores for use in non-Best manufactured locks for which Best has an equivalent product. Best Patented Masterkey System products shall not be provided without the associated masterkey services being provided by dormakaba USA. All Masterkey Services provided by dormakaba USA shall be subject to the terms and conditions of the Best Masterkey Service Order Acknowledgment which shall be provided upon acceptance of the order for Masterkey Services.

### B. BEST BESTCODE:

dormakaba USA may, in its sole discretion, make available its BESTCode masterkey code management tool to select Authorized Distributors that meet certain training and certification requirements. If offered, BESTCode will be made available for an annual subscription fee as outlined in the Best pricing catalog. All codes made available to Authorized Distributors in the BESTCode system shall be subject to the BESTCode User License Agreement and will be provided in accordance with this Policy. The BESTCode masterkey code management tool is not available for use with Stanley Commercial Hardware products.

### III. FORMS

For a copy of the following forms please contact the dormakaba USA End User Consultant.

- End User Information and Code Release Agreement
- Best Patented Masterkey System Distributor Agreement Addendum (Exhibit B)
- Best Patented Masterkey System Security Authorization Form
- Best Patented Key Systems Security Procedure
- Best Patented Masterkey System Exclusive Keyway Addendum
- Best Patented Masterkey System End User Specific Distributor Agreement Addendum (Exhibit D)

dormakaba USA reserves the right to change, modify or update this Policy at any time, in its sole discretion.

May 2018



## Architectural Finishes

| <b>BHMA<br/>No.</b> | <b>U.S.<br/>No.</b> | <b>Description</b>                 |
|---------------------|---------------------|------------------------------------|
| 605                 | 3                   | Bright brass, clear coated         |
| 606                 | 4                   | Satin brass, clear coated          |
| 611                 | 9                   | Bright bronze, clear coated        |
| 612                 | 10                  | Satin bronze, clear coated         |
| 613                 | 10B                 | Oxidized satin bronze, oil rubbed  |
| 618                 | 14                  | Bright nickel plated, clear coated |
| 619                 | 15                  | Satin nickel plated, clear coated  |
| 622                 | 19                  | Flat black, coated                 |
| 625                 | 26                  | Bright chromium plated             |
| 626                 | 26D                 | Satin chromium plated              |
| 627                 | 27                  | Satin aluminum, clear coated       |
| 628                 | 28                  | Satin aluminum, clear anodized     |
| 629                 | 32                  | Bright stainless steel             |
| 630                 | 32D                 | Satin stainless steel              |
| 690                 | 20                  | Dark bronze coated                 |



## BEST Standard & Premium Keys

### How To Order

| 1A   | 1  | A  | 1                    |   |   |
|--|--|--|----------------------|---|---|
| Key Shape (Bow)  | Key Type   | Keyway   | Cut Code             | Key Stamp   | Options   |
| 1A – Standard<br>1AP – Premium<br>2A – Large round<br>3A – Large rectangular<br>4A – Access bow<br>9A – Blockout blade | 0 – Blockout blade<br>1 – Operating or blank<br>2 – Control<br>3 – Master<br>4 – Submaster<br>5 – Grandmaster<br>9 – Extractor key | Designate specific keyway (A, E, etc.) or multiple keyways if ordering a multi-milled key. | 1 – Blank<br>2 – Cut | KS473 x KS800 (1A only)<br>KS112 – "U.S. Gov't do not duplicate"<br>KS567 – Premium<br><br>Specify KS#. Price for most custom design stamps available upon request. | B* – Long blade (1A only)<br>H* – No hole (2A only)<br>N* – Long nose (1A only)<br>NKW – No keyway designation (standard on 1AP)<br>P* – Plastic insert (4A only)<br>S* – Key serialization |

\*Indicates extra cost option; see below.

If keys are cut, you must specify keymark and number of each marking.

| DESCRIPTION                   | PREMIUM | STANDARD |
|-------------------------------|---------|----------|
| <b>1A SERIES</b>              |         |          |
| Blanks                        | 5.60    | 3.20     |
| Operating-cut                 | 14.30   | 10.10    |
| Control, Master, SM or GM-cut | 19.00   | 11.20    |
| <b>2A, 3A &amp; 4A SERIES</b> |         |          |
| Blanks                        | N/A     | 5.50     |
| Operating-cut                 | N/A     | 11.30    |
| Control, Master SM or GM-cut  | N/A     | 6.30     |
| <b>9A SERIES</b>              |         |          |
| Blockout blades               | 16.70   | 11.90    |
| Extractor key (9A9)           | 16.70   | 11.90    |

| EXTRA COST OPTIONS*     | OPTION CODE      | ADD-ON |
|-------------------------|------------------|--------|
| Double milling          | Specific Keyways | 3.40   |
| Triple milling          |                  | 5.40   |
| Quadruple milling       |                  | 8.20   |
| Five milled             |                  | 13.00  |
| Long blade (1A only)    | B                | 3.40   |
| No hole (2A only)       | H                | 2.20   |
| Long nose (1A only)     | N                | 6.50   |
| Key serialization / key | S                | 2.20   |

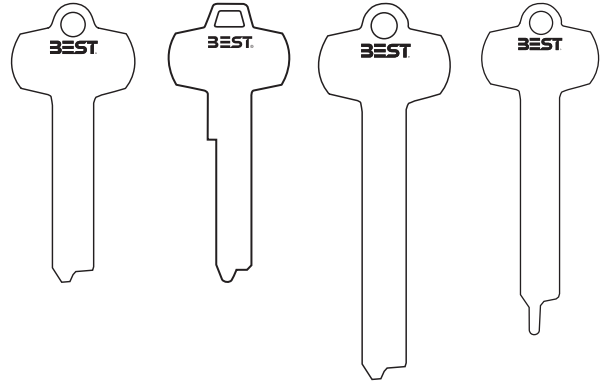

1A Standard      1AP Premium      1A Long Blade (B)\*      1A Long Nose (N)\*

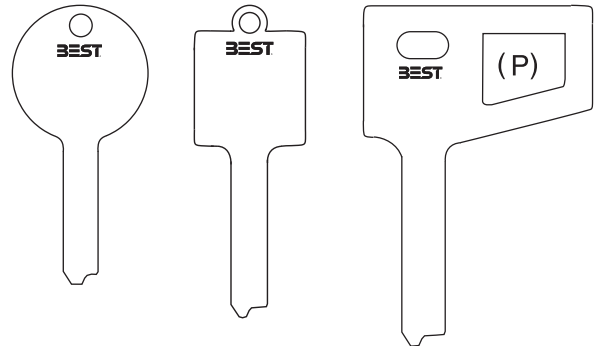

2A      3A      4A\*



9A0 Blockout Blade      9A9 Extractor Key



# BEST Peaks® Keys

## How To Order

| 1AK                                      | 1   | B1  | 1                    | 7   | 150        |   |
|--|---|---|----------------------|---|------------|---|
| Key Shape (Bow)                          | Key Type  | Keyway  | Cut Code             | Pin Size  | Key Series | Options                                 |
| 1AK – BEST Peaks<br>9AK – Blockout blade | 0 – Blockout blade<br>1 – Operating<br>2 – Control<br>3 – Master<br>4 – Submaster<br>5 – Grandmaster<br>9 – Extractor key | B1<br>B2<br>B3<br>B4<br>B5<br>B6<br>B7<br>B8<br>B9<br>B10 | 1 – Blank<br>2 – Cut | 6 – 6-pin (140 & 150 series)<br>7 – 7-pin (150 series only)<br>140 Series = 1CK cores<br>150 Series = 1CB cores | 150<br>140 | CS* – Custom stamp for key bow (Note 1) |

\*Indicates extra cost option; see below.

If keys are cut, you must specify keymark and number of each marking.

| DESCRIPTION                   | PATENTED |
|-------------------------------|----------|
| <b>1AK SERIES</b>             |          |
| Blanks                        | 9.30     |
| Operating-cut                 | 22.00    |
| Control, Master, SM or GM-cut | 25.00    |

| EXTRA COST OPTIONS*                      |      |
|--|------|
| List price add-on per key blank (Note 2) | 1.80 |

NOTE 1: One-time die stamping charge will be required. Pricing for special stamps and graphics are available upon request.

NOTE 2: Minimum 200 Keys Per Order





## BEST Preferred Patented Keys

### How To Order

| 1AF  | 1   | 1P                                | 1                    | 7                                     |  |
|--|---|-----------------------------------|----------------------|---------------------------------------|--|
| Key Shape (Bow)  | Key Type  | Keyway                            | Cut Code             | Pin Size                              | Options                                    |
| 1AF – Preferred Patented<br>9AF – Preferred Blockout Blade | 0 – Blockout blade<br>1 – Operating<br>2 – Control<br>3 – Master<br>4 – Submaster<br>5 – Grandmaster<br>9 – Extractor key | 1P<br>2P<br>7P<br>8P<br>9P<br>10P | 1 – Blank<br>2 – Cut | 7 – 7-pin (150 series 1CF cores only) | CS* – Custom stamp for key bow<br>(Note 1) |

\*Indicates extra cost option; see below.

If keys are cut, you must specify keymark and number of each marking.

| DESCRIPTION                        | PATENTED |
|------------------------------------|----------|
| <b>1AF SERIES</b>                  |          |
| PATENTED blanks                    | 9.60     |
| Operating-cut                      | 22.00    |
| Control, Master, SM or GM-cut      | 26.00    |
| <b>9AF SERIES</b>                  |          |
| Blockout blade & extractor key set | 80.00    |

| EXTRA COST OPTIONS*                      |      |
|--|------|
| List price add-on per key blank (Note 2) | 1.80 |

NOTE 1: One-time die stamping charge will be required. Pricing for special stamps and graphics are available upon request.

NOTE 2: Minimum 200 Keys Per Order



## BEST CORMAX™ Patented Keys

### How To Order - M Series

| 1AM  | 1  | MM             | 2   | 1                    | KS716  |   |
|--|--|----------------|---|----------------------|--|---|
| Key Shape (Bow)  | Key Type   | Keyway         | Level   | Cut Code             | Key Stamp  | Options   |
| 1AM – M series key<br>2AM – Large round<br>3AM – Large rectangular<br>4AM – Access bow<br>9AM – Blockout blade | 0 – Blockout blade<br>1 – Operating or blank<br>2 – Control<br>3 – Master<br>4 – Submaster<br>5 – Grandmaster<br>9 – Extractor key | MJ MK<br>ML MM | 1 – Non-exclusive<br>2 – Two-digit zip code exclusive<br>3 – One digit zip code exclusive<br>4 – National exclusive | 1 – Blank<br>2 – Cut | KS716 - 1AM Front<br>KS717 - 1AM Front<br>KS800 - 1AM Back | B* – Long blade (1AM series only)<br>H* – No hole (2AM series only)<br>N* – Long nose (1AM series only)<br>S* – Key serialization |

\*Indicates extra cost option; see below.

Designate multiple keyways if ordering a multi-milled key.

If keys are cut, you must specify keymark and number of each marking.

\*\*Must specify keyway when ordering blockout blades

### How To Order - X Series

| 1AX  | 1  | X1            | X   | 1                    | KS699            |                        |
|--|--|---------------|---|----------------------|------------------|------------------------|
| Key Shape (Bow)                            | Key Type   | Keyway        | Level   | Cut Code             | Key Stamp        | Options                |
| 1AX – X series key<br>9AX – Blockout blade | 0 – Blockout blade<br>1 – Operating or blank<br>2 – Control<br>3 – Master<br>4 – Submaster<br>5 – Grandmaster<br>9 – Extractor key | X1..X32, etc. | W - Non-exclusive<br>X - Two-digit zip code exclusive<br>Y - One digit zip code exclusive<br>Z - National exclusive | 1 – Blank<br>2 – Cut | KS699 - 1AX Back | S* – Key serialization |

\*Indicates extra cost option; see below.

Designate multiple keyways if ordering a multi-milled key.

If keys are cut, you must specify keymark and number of each marking.

\*\*Must specify keyway when ordering blockout blades

| DESCRIPTION                      | PATENTED |
|----------------------------------|----------|
| <b>1AM SERIES</b>                |          |
| Blanks                           | 6.10     |
| Operating-cut                    | 13.20    |
| Control, Master, SM or GM-cut    | 14.50    |
| <b>1AX SERIES</b>                |          |
| Blanks                           | 6.10     |
| Operating-cut                    | 13.20    |
| Control, Master, SM or GM-cut    | 14.50    |
| <b>2AM, 3AM &amp; 4AM SERIES</b> |          |
| Blanks                           | 6.30     |
| Operating-cut                    | 11.70    |
| Control, Master SM or GM-cut     | 18.00    |
| <b>9AM &amp; 9AX SERIES</b>      |          |
| Blockout Blades                  | 14.50    |
| Extractor key (9AM9 or 9AX9)     | 14.50    |

| EXTRA COST OPTIONS*     | OPTION CODE      | ADD-ON |
|-------------------------|------------------|--------|
| Double milling          | Specific Keyways | 3.40   |
| Quadruple milling       |                  | 8.20   |
| Long blade (1AM only)   | B                | 3.40   |
| No hole (2AM only)      | H                | 2.20   |
| Long nose (1AM only)    | N                | 6.50   |
| Key serialization / key | S                | 2.20   |

#### NOTES:

- 1: M Series key ways are backward compatible with STANDARD key ways of the same letter.
- 2: X Series key ways are NOT backward compatible.
- 3: Please contact factory for information regarding all security levels for the M and X Series. Levels 2, 3 and 4 require Masterkey Department authorization.
- 4: Match key keyways level to core key way level.
- 5: 3AM keys are available with M series keyways only



## B Series Padlocks

### How To Order

| 41B  | 7   | 2   | L  |   |  |  |
|--|---|---|--|---|--|--|
| Shackle Diameter   | Core Housing                              | Shackle Height  | Function                                 | Chain Option  | Special Stamp No.  | Options  |
| 11B – Brass 1/4" dia.<br>21B – Brass 5/16" dia.<br>41B – Brass 3/8" dia. | 7 – 7-pin housing; accepts all BEST cores | Steel shackle<br>2 – 3/4"<br>21 – 1" w/ shroud (21B only)<br>22 – 1 1/2"<br>72 – 2"<br>82 – 4"<br><br>Bronze shackle<br>0 – 3/4"<br>20 – 1 1/2"<br>70 – 2"<br>80 – 4" | T – Key retained<br>L – Non-key retained | M – Case drilled for clevis only<br>M1* – Bronze chain<br>M5* – Galvanized steel chain<br>M/CR* – Clevis Only | Blank – Best logo<br>PS1010 – Safety first (11B & 21B)<br><br>Specify PS# or describe stamp.<br><br>Price for special stamps available upon request. | F3 – Frangible shackle (11B720 only)<br>O* – Lockout/tagout<br>S* – Car seal (41B only)<br>ZZ* – Double lockout (11B only)<br>XSPL* – Cut resistant shackle (21B & 41B only)<br>WC* – Weather cover (21B & 41B only)<br>SH – Shrouded padlock w/cut resistant shackle (21B only)<br>606* – Satin Brass finish (brass only) |

\*Indicates extra cost; see the last page of B Series.

Must specify keymark and number of keys or designate L/C for less core.

| SHACKLE HEIGHT                 | SHACKLE CODE |       | COMPLETE WITH COMBINATED CORE |         |          | LESS CORE |
|--------------------------------|--------------|-------|-------------------------------|---------|----------|-----------|
|                                | BRONZE       | STEEL | PATENTED**                    | PREMIUM | STANDARD |           |
| <b>11B SERIES</b>              |              |       |                               |         |          |           |
| 3/4"                           | 0            | 2     | 142.00                        | 142.00  | 130.00   | 60.00     |
| 1-1/2"                         | 20           | 22    | 142.00                        | 142.00  | 130.00   | 60.00     |
| 2"                             | 70           | 72    | 145.00                        | 145.00  | 133.00   | 63.00     |
| 4"                             | 80           | 82    | 153.00                        | 153.00  | 141.00   | 71.00     |
| <b>21B SERIES</b>              |              |       |                               |         |          |           |
| 3/4"                           | 0            | 2     | 143.00                        | 143.00  | 131.00   | 61.00     |
| 1-1/2"                         | 20           | 22    | 143.00                        | 143.00  | 131.00   | 61.00     |
| 2"                             | 70           | 72    | 146.00                        | 146.00  | 134.00   | 64.00     |
| 4"                             | 80           | 82    | 154.00                        | 154.00  | 142.00   | 72.00     |
| <b>41B SERIES</b>              |              |       |                               |         |          |           |
| 3/4"                           | 0            | 2     | 145.00                        | 145.00  | 133.00   | 63.00     |
| 1-1/2"                         | 20           | 22    | 145.00                        | 145.00  | 133.00   | 63.00     |
| 2"                             | 70           | 72    | 148.00                        | 148.00  | 136.00   | 66.00     |
| 4"                             | 80           | 82    | 156.00                        | 156.00  | 144.00   | 74.00     |
| <b>21B Series with Shroud*</b> |              |       |                               |         |          |           |
| 1"                             | N/A          | 21    | 199.00                        | 199.00  | 187.00   | 117.00    |

\*Pricing includes stainless steel shroud and cut-resistant shackle. Must include "SH" option when ordering

\*\*Patented pricing shown is for CORMAX patented keying system. Add \$20.00 for BEST Preferred patented keying.

NOTE: 626 finish is standard on brass padlock series.

## B Series Padlocks (continued)

| DESCRIPTION                                      | CATALOG NUMBER | COMPLETE WITH COMBINATED CORE |         |          | LESS CORE |
|--|----------------|-------------------------------|---------|----------|-----------|
|  |                | PATENTED                      | PREMIUM | STANDARD |           |
| <b>CABLE PADLOCKS</b>                            |                |                               |         |          |           |
| Jacketed – 24" cable                             | 21JB7-24T      | 164.00                        | 164.00  | 152.00   | 82.00     |
| Jacketed – 36" cable                             | 21JB7-36T      | 174.00                        | 174.00  | 162.00   | 92.00     |
| Jacketed – 48" cable                             | 21JB7-48T      | 181.00                        | 181.00  | 169.00   | 99.00     |
| Extra cable per ft. or fraction thereof jacketed | Add-On         | 8.80                          | 8.80    | 8.80     | 8.80      |

| EXTRA COST OPTIONS*                   | OPTION CODE | ADD-ON |
|---------------------------------------|-------------|--------|
| Bronze chain                          | M1          | 11.00  |
| Galvanized steel chain                | M5          | 19.00  |
| Lockout / tagout                      | O           | 15.00  |
| Padlock weather covers (21B-41B only) | WC          | 7.30   |
| Cut resistant shackle                 | XSPL        | 26.00  |
| Car seal slot (41B only)              | S           | 21.00  |
| Satin Brass Finish                    | 606         | 21.00  |
| Double lockout safety (11B only)      | ZZ          | 25.00  |
| Clevis Only                           | M/CR        | 6.00   |

| ACCESSORIES            | CATALOG NUMBER | PRICE  |
|------------------------|----------------|--------|
| Frangible shackle kit* | 11B20FK        | 200.00 |
| Frangible shackle only | 11B20FF        | 11.00  |

| REPAIRS   | SERIES | PRICE |
|---|--------|-------|
| Includes all new parts, even a shackle, if necessary, but not a core or a new chain | 11B    | 41.00 |
|   | 21B    | 41.00 |
|   | 41B    | 41.00 |

NOTE: Chain options are not available on cable padlocks, weather covers, or padlocks with shroud.

\*Includes: padlock disassembly tool, three shackles and springs.



**M1**



**M5**

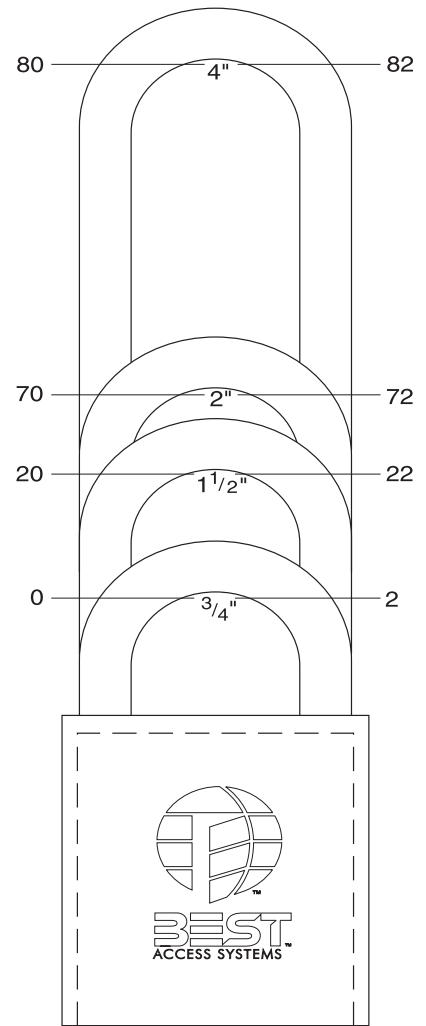



## BEST Standard & Premium Cores

### How To Order

| 1C   | 7   | A                                      | 1  |  | 606                                      |
|--|---|--|--|--|--|
| Core Type  | Core Size   | Keyway                                 | Combining Code                                   | Options  | Finish                                   |
| 1C – Standard<br>1CD – Drill resistant<br>1CDP – Drill resistant Premium<br>1CP – Premium<br>2C** – Core for 8L mailbox<br>3C – Core for 8E cylinder<br>5C** – High security<br>6C – Core for 4S cylinders<br>6CP – Premium core for 4S cylinder | 5 – 5-pin (1C only)<br>6 – 6-pin (1C only)<br>7 – 7-pin | Designate specific keyway (A, E, etc.) | 1 – Uncombined<br>2 – Combined (B, W, P options) | B* – Pick & drill resistant (1CD only)<br>K* – Key trap (1C only)<br>P* – Pick resistant<br>T* – Key retained (6C & 6CP only)<br>W* – Wear resistant | 605 606<br>611 612<br>613 625<br>626 690 |

\*Indicates extra cost option; see below. \*\*Requires long blade key.  
If combined, you must specify keymark and number of keys.  
5C Core is only compatible with a high security cylinder - 1EJ & 1EK

| DESCRIPTION                  | COMBINATING CODE | PREMIUM | STANDARD |
|------------------------------|------------------|---------|----------|
| <b>1C &amp; 1CP SERIES</b>   |                  |         |          |
| Uncombined                   | 1                | 50.00   | 44.00    |
| Combined                     | 2                | 82.00   | 70.00    |
| <b>1CD &amp; 1CDP SERIES</b> |                  |         |          |
| Uncombined                   | 1                | 70.00   | 64.00    |
| Combined                     | 2                | 102.00  | 90.00    |
| <b>2C &amp; 3C SERIES</b>    |                  |         |          |
| Uncombined                   | 1                | N/A     | 47.00    |
| Combined                     | 2                | N/A     | 72.00    |
| <b>5C SERIES</b>             |                  |         |          |
| Uncombined                   | 1                | N/A     | 64.00    |
| Combined                     | 2                | N/A     | 84.00    |
| <b>6C &amp; 6CP SERIES</b>   |                  |         |          |
| Uncombined                   | 1                | 55.00   | 47.00    |
| Combined                     | 2                | 88.00   | 72.00    |

| EXTRA COST OPTIONS*       | OPTION CODE |     | ADD-ON |
|---------------------------|-------------|-----|--------|
| Pick &/or drill resistant | B,P         | N/A | 20.00  |
| Key trap                  | K           | N/A | 9.10   |
| Key retained              | T           | N/A | 9.10   |
| Wear resistant            | W           | N/A | 9.10   |

| PART DESCRIPTION            | PART NO.     | QUANTITY PER PKG. | PRICE PER PKG. |
|-----------------------------|--------------|-------------------|----------------|
| Standard pin segments       | A0, A1 etc.  | 100               | 9.80           |
| Spool pin segments (Note 1) | A6, A7, etc. | 100               | 12.00          |
| Stainless steel segments    | A0, A1, etc. | 100               | 51.00          |
| Core caps (500 per pkg.)    | 21C          | 500               | 16.00          |
| Core springs (500 per pkg.) | 22S          | 500               | 38.00          |

NOTE: Standard spool pin segments are available in the following sizes: A6; A7; A8; A9; B8; B10; C3; C4; C5; C6; D6; D8; E3; E4; E5; F6; F7; & F8. (B6 spool pin segments should not be used with 5C core.)

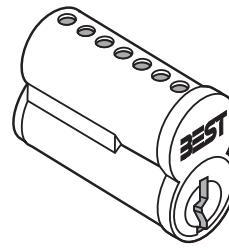

1C – 7-pin

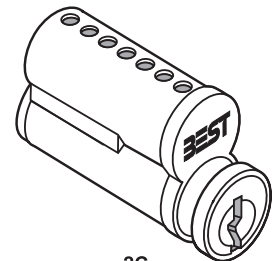

2C  
(Requires long blade key)

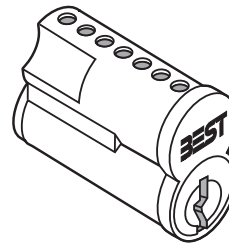

3C

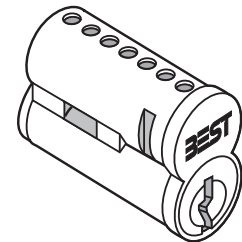

5C  
(Requires long blade key)



6C

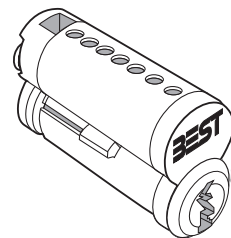

6CP



## BEST Peaks® Cores

### How To Order

| 1CB                                  | 7   | B1                       | 1                              | 626                                |   |
|--------------------------------------|---|--------------------------|--------------------------------|------------------------------------|---|
| Core Type                            | Core Size   | Keyway                   | Combining Code                 | Finish                             | Style   |
| 1CB – 150 Series<br>1CK – 140 Series | 6 – 6-pin (140 & 150 series)<br>7 – 7-pin (150 series only) | B1 B6<br>B2 B7<br>B3 B10 | 1 – Uncombined<br>2 – Combined | 626 – Simulated<br>606 – Simulated | 3840 - BEST I/C 6 pin 140 series<br>See the list below for other options. |

\*If combined, you must specify keymark and number of keys.

#### 1CB SERIES PEAKS CORES

| SERIES STYLE                | DESCRIPTION                     | COMBINED | UNCOMBINED |
|-----------------------------|---------------------------------|----------|------------|
| <b>INTERCHANGEABLE CORE</b> |                                 |          |            |
| 3856                        | BEST I/C 6-pin brass 150 Series | 100.00   | 60.00      |
| 3857                        | BEST I/C 7-pin brass 150 Series | 100.00   | 60.00      |

#### 1CK SERIES PEAKS CORES

| SERIES STYLE                                      | DESCRIPTION  | COMBINED | UNCOMBINED |
|---|--|----------|------------|
| <b>INTERCHANGEABLE CORE</b>                       |  |          |            |
| 3840  | BEST I/C 6-pin brass 140 Series  | 122.00   | 77.00      |
| <b>CONVENTIONAL CYLINDERS (KIK = Key in Knob)</b> |  |          |            |
| 3404  | Corbin Russwin CK4200 grade, 1 knob & UT5200 unit lock   | 122.00   | 77.00      |
| 3406  | Arrow, LSDA, Schlage "06" kit includes 2 security bushings, 3 faced tailpieces   | 122.00   | 77.00      |
| 3408  | Sargent 7, 8 & 9 line knob   | 122.00   | 77.00      |
| 3410  | Sargent Kit for 6,10, 65 line and 2000 exit device line; includes security bushing and 2 fixed tailpieces (Use A and E bottom pins only) | 122.00   | 77.00      |
| 3454  | Yale 5300 grade 2 & 5400 grade 1 knob  | 122.00   | 77.00      |
| 3455  | Corbin Russwin CL3900 & Yale 5400LN grade 1 lever  | 122.00   | 77.00      |
| 3476  | Sargent 7600 Integra Lock  | 122.00   | 77.00      |
| 3495  | Falcon, Sargent & Weiser cyl. kit for small dia. plug faces; 3 fixed & 3 lost motion tailpiece (Use J or K bottom pins only)             | 122.00   | 77.00      |
| 3499*   | Peaks Universal "99" cyl. kit includes 3 fixed & 3 lost motion tailpieces (Use J or K bottom pins only)                                  | 122.00   | 77.00      |

\*The 3499 universal cylinder should be used for all Key in Knob applications except Falcon, Sargent, Weiser Locks and specialty applications listed above. Refer to the BEST Peaks Technical Manual for various KIK Tailpiece Configurations.

| <b>REMOVABLE CORE</b> |                                  |        |       |
|-----------------------|----------------------------------|--------|-------|
| 6140                  | 6-pin Corbin Russwin R/C         | 136.00 | 86.00 |
| 6240-6                | 6-pin Yale R/C                   | 136.00 | 86.00 |
| 6240-7                | 6-pin for 7-pin housing Yale R/C | 136.00 | 86.00 |
| 6340                  | 6-pin Medeco R/C                 | 136.00 | 86.00 |
| 6440                  | 6-pin Schlage R/C                | 141.00 | 96.00 |
| 6540                  | 6-pin Sargent R/C                | 136.00 | 86.00 |



## BEST Preferred Patented Cores

### How To Order

| 1CF  | 7                              | 1P                       | 1                              |  |  | 626  |
|--|--------------------------------|--------------------------|--------------------------------|--|--|--|
| Core Type  | Core Size                      | Keyway                   | Combining Code                 | Style                                    | Options  | Finish   |
| 1CF - 150 Series Patented<br>3CF - Core for 8E Cylinder 150 Series<br>6CF - Core for 4S Cylinders 150 Series | 7 - 7-pin<br>(150 series only) | 1P 2P<br>7P 8P<br>9P 10P | 1 - Uncombined<br>2 - Combined | See list below<br>for style op-<br>tions | (150 Series only)<br><br>B* - Pick & drill resistant<br>(1CDF only)<br>K* - Key trap<br>P* - Pick resistant<br>T* - Key retained (6CF only)<br>W* - Wear resistant<br>D* - Drill Resistant | 626 - Simulated<br>606 - Simulated<br>612 - Simulated<br>613 - Simulated |

\*Indicates extra cost option; see below  
If combined, you must specify keymark and number of keys.

| 1CF, 1CDF, 3CF AND 6CF PREFERRED PATENTED CORES                  |          |            |
|--|----------|------------|
| DESCRIPTION  | COMBINED | UNCOMBINED |
| <b>INTERCHANGEABLE CORE</b>                                      |          |            |
| 1CF - BEST Preferred I/C 7-pin brass 150 series                  | 102.00   | 70.00      |
| 1CDF - BEST Preferred drill resistant I/C 7-pin brass 150 series | 122.00   | 92.00      |
| 3CF - BEST Preferred I/C for 8E cylinder 7-pin brass 150 series  | 120.00   | 75.00      |
| 6CF - BEST Preferred I/C for 4S cylinder 7-pin brass 150 series  | 120.00   | 75.00      |

\*The 3499 universal cylinder should be used for all Key in Knob applications except Falcon, Sargent, Weiser Locks and specialty applications listed above. Refer to the BEST Peaks Technical Manual for various KIK Tailpiece Configurations.

| EXTRA COST OPTIONS          | OPTION CODE | ADD-ON |
|-----------------------------|-------------|--------|
| Pick and/or drill resistant | B, D, P     | 20.00  |
| Key Trap                    | K           | 9.10   |
| Key Retained                | T           | 9.10   |
| Wear Resistant              | W           | 9.10   |





## BEST CORMAX™ Patented Cores

### How To Order - M Series

| 1CM  | 7                      | MJ             | 3   | 1                              |   | 626                                      |
|--|------------------------|----------------|---|--------------------------------|---|--|
| Core Type  | Core Size              | Keyway         | Level   | Combining Code                 | Options   | Finish                                   |
| 1CM – CORMAX Core M Series<br>1CDM – CORMAX Drill resistant<br>5CM** – CORMAX for High security<br>6CM – CORMAX Core for 4S cylinder | 6 – 6-pin<br>7 – 7-pin | MJ MK<br>ML MM | 1 – Non-exclusive<br>2 – Two-digit zip code exclusive<br>3 – One digit zip code exclusive<br>4 – National exclusive | 1 – Uncombined<br>2 – Combined | B* – Pick & drill resistant (1CDM combined core only)<br>K* – Key trap (1CM only)<br>P* – Pick resistant<br>T* – Key retained (6CM only)<br>W* – Wear resistant | 605 606<br>611 612<br>613 625<br>626 690 |

### How To Order - X Series

| 1CX  | 7                      | X1            | W   | 1   |   | 626                                      |
|--|------------------------|---------------|---|---|---|--|
| Core Type  | Core Size              | Keyway        | Level   | Combining Code                            | Options   | Finish                                   |
| 1CX – CORMAX Core X Series<br>1CDX – CORMAX Drill resistant<br>6CX - CORMAX Core for 4S cylinder | 6 – 6-pin<br>7 – 7-pin | X1..X32, etc. | W – Non-exclusive<br>X – Two-digit zip code exclusive<br>Y – One digit zip code exclusive<br>Z – National exclusive | 1 – Uncombined<br>2 – Combined (B Option) | B* – Pick & drill resistant (1CDX combined core only)<br>P* – Pick resistant<br>W* – Wear resistant | 605 606<br>611 612<br>613 625<br>626 690 |

\*Indicates extra cost option; see below

If combined, you must specify keymark and number of keys. \*\*Only compatible with high security mortise cylinder - 1EJ & 1EK

| DESCRIPTION               | COMBINATING CODE | CORMAX |
|---------------------------|------------------|--------|
| <b>1CM / 1CX SERIES</b>   |                  |        |
| Uncombined                | 1                | 60.00  |
| Combined                  | 2                | 82.00  |
| <b>1CDM / 1CDX SERIES</b> |                  |        |
| Uncombined                | 1                | 80.00  |
| Combined                  | 2                | 102.00 |
| <b>5CM SERIES</b>         |                  |        |
| Uncombined                | 1                | 73.00  |
| Combined                  | 2                | 91.00  |
| <b>6CM SERIES</b>         |                  |        |
| Uncombined                | 1                | 63.00  |
| Combined                  | 2                | 83.00  |
| <b>6CX SERIES</b>         |                  |        |
| Uncombined                | 1                | 63.00  |
| Combined                  | 2                | 83.00  |

| EXTRA COST OPTIONS*       | OPTION CODE | ADD-ON |
|---------------------------|-------------|--------|
| Pick &/or drill resistant | P & B       | 20.00  |
| Key trap                  | K           | 9.10   |
| Key retained              | T           | 9.10   |
| Wear resistant            | W           | 9.10   |

#### NOTES

- 1: M Series key ways are backward compatible with Standard key ways of the same letter.
- 2: X Series key ways are NOT backward compatible.
- 3: Please contact factory for information regarding all security levels for the M and X Series. Levels 2, 3 and 4 require Masterkey Department authorization.
- 4: Match key keyways level to core key way level.

| PART DESCRIPTION            | PART NO.     | QUANTITY PER PKG. | PRICE PER PKG. |
|-----------------------------|--------------|-------------------|----------------|
| Standard pin segments       | A0, A1 etc.  | 100               | 9.80           |
| Spool pin segments (Note 1) | A6, A7, etc. | 100               | 12.00          |
| Stainless steel segments    | A0, A1, etc. | 100               | 51.00          |
| Core caps (500 per pkg.)    | 21C          | 500               | 16.00          |
| Core springs (500 per pkg.) | 22S          | 500               | 38.00          |

NOTE: Standard spool pin segments are available in the following sizes: A6; A7; A8; A9; B8; B10; C3; C4; C5; C6; D6; D8; E3; E4; E5; F6; F7; & F8. (B6 spool pin segments should not be used with 5C core.



## D Series Service Equipment

The security items in this series are available only to registered BEST Masterkey System owners. The restriction is for the purpose of avoiding proliferation of equipment that could be used to compromise the security of such systems.

| DESCRIPTION  | CATALOG NO.   | PRICE   |
|--|---------------|---------|
| <b>AD SERIES - KEY EQUIPMENT</b>                           |               |         |
| Key combinator (Standard & CORMAX)                         | AD433*        | 5507.00 |
| Key combinator—Premium                                     | AD433P*       | 6323.00 |
| Key carriage (Standard & CORMAX M Series keyways)          | AD434         | 858.00  |
| Key carriage—Premium                                       | AD434P        | 714.00  |
| Key combinator system conversion                           | Call to Order | 710.00  |
| Key cut indicator (in CD431 Kit)                           | AD501*        | 40.00   |
| Key calibrator (mechanical)                                | AD502         | 882.00  |
| Key calibrator (digital)                                   | AD502D        | 2265.00 |
| Key stamping plate (55 standard keys)                      | AD504A        | 1949.00 |
| <b>BD SERIES - PADLOCK EQUIPMENT</b>                       |               |         |
| Assembly kit complete                                      | BD640         | 462.00  |
| Tweezers—6" (in BD640 Kit)                                 | BD641         | 28.00   |
| Shackle plug tool (in BD640 Kit)                           | BD642         | 332.00  |
| Holding plate (in BD640 Kit)                               | BD643         | 108.00  |
| Rivet flaring tool   | BD650         | 279.00  |
| Storage hook (41B & 61B)                                   | BD651         | 20.00   |
| Padlock disassembly tool (11B, 21B, 41B)                   | BD654         | 195.00  |
| Lockout  | BD655         | 24.00   |
| Lockout ties (pkg. of 50)                                  | BD656A        | 37.00   |
| Lockout name tag   | BD657         | 7.50    |
| Lockout / tagout   | BD658         | 7.50    |
| Corrosion free lubricant - 2 oz Squeeze Bottle             | BD670         | 40.00   |
| Corrosion free lubricant - 28.74 oz Refill                 | BD680         | 91.00   |
| <b>CD SERIES - CORE EQUIPMENT</b>                          |               |         |
| Combinating kit complete                                   | CD431*        | 1096.00 |
| Combinating bin  | CD433         | 440.00  |
| Stamping plate—face only (87 cores)                        | CD504B        | 1949.00 |
| Stamping plate—side only (50 cores)                        | CD504C        | 1949.00 |
| Core capping / decapping press                             | CD517         | 2960.00 |
| Graphite gun   | CD535         | 35.00   |
| Graphite—1 lb. container                                   | CD535A        | 60.00   |
| Capping / decapping block for 1C 150 (in CD431 Kit)        | CD540         | 222.00  |
| Hand capping pin for use with capping block (in CD431 Kit) | CD547         | 29.00   |
| Ejector pin (in CD431 Kit)                                 | CD548         | 20.00   |
| Tweezers—3" (in CD431 Kit)                                 | CD549         | 6.50    |
| Combinating bin kit  | CD435         | 2209.00 |
| <b>DD SERIES - COMBINATING EQUIPMENT</b>                   |               |         |
| Letter dies—1/16" or 3/32"                                 | DD502         | 279.00  |
| Number dies—1/16" or 3/32"                                 | DD503         | 97.00   |
| Core / key marking block (1 core & key)                    | DD513         | 222.00  |
| Core / key marking plate (5 cores & 10 keys)               | DD514         | 571.00  |
| Magnetic strip (2 ea. in DD514)                            | DD514A        | 5.40    |
| Combinating hammer with plastic head                       | DD550         | 134.00  |
| Plastic heads (for DD550)                                  | DD551         | 40.00   |

\*Specify A2, A3 or A4 keying system

| DESCRIPTION                                      | CATALOG NO. | PRICE   |
|--|-------------|---------|
| <b>ED SERIES - CYLINDER EQUIPMENT</b>            |             |         |
| Mortise cylinder wrench                          | ED211       | 50.00   |
| Mortise cylinder assembly tool                   | ED212       | 87.00   |
| Thread repair die 1E cylinder                    | ED221       | 608.00  |
| Cylinder cam testing tool                        | ED222       | 52.00   |
| 3E Cylinder hole tap                             | ED224       | 524.00  |
| 1E Cylinder hole tap                             | ED225       | 524.00  |
| Eurocylinder wrench                              | ED801       | 180.00  |
| 5E Combinating kit complete (Note 1)             | 5ED250      | 1173.00 |
| 5E Thread tap—3/4" x 24                          | 5ED253      | 236.00  |
| 5E Capping block (in 5ED250 Kit)                 | 5ED261      | 344.00  |
| 5E Cap depressor (in 5ED250 Kit)                 | 5ED262      | 94.00   |
| <b>KA SERIES - DOOR ADAPTOR KITS</b>             |             |         |
| Mortise to cylindrical 1" faceplate              | 62KA2A      | 100.00  |
| Mortise to cylindrical 1-1/8" faceplate          | 83KA2A      | 102.00  |
| Wrap-around 2-3/8" backset (160)                 | 62KA2B      | 100.00  |
| Wrap-around 2-3/4" backset (161)                 | 83KA2B      | 102.00  |
| <b>KD SERIES - CYLINDRICAL/TUBULAR EQUIPMENT</b> |             |         |
| 9K Throughbolt drill jig                         | KD303       | 9.10    |
| Boring jig kit complete (Note 3)                 | KD304A      | 1310.00 |
| Drill bit—2-1/8"                                 | KD308       | 440.00  |
| Faceplate marking chisel (160)                   | KD312       | 120.00  |
| Faceplate marking chisel (161) 1-1/8"            | KD315       | 120.00  |
| 8K Spanner wrench                                | KD316       | 9.10    |
| 9K Spanner wrench                                | KD317       | 9.10    |
| Drill bit—1" x 9"                                | KD318       | 97.00   |
| Strike plate locating pin                        | KD325       | 40.00   |
| Return spring loading tool                       | KD340       | 82.00   |
| <b>KNOB ADAPTATION CUT-OFF FIXTURES FOR:</b>     |             |         |
| Schlage D Series                                 | KD352S      | 227.00  |
| Yale #5400                                       | KD351Y      | 227.00  |

### NOTES:

- 1: Specify A2, A3 or A4 keying system.
- 2: Specify door thickness (630 finish only).
- 3: KD304A includes a boring jig and a 3/8" adapter chuck. (The boring jig and 3/8" adaptor chuck are not sold sperately).



## D Series Service Equipment (continued)

The security items in this series are available only to registered BEST Masterkey System owners. The restriction is for the purpose of avoiding proliferation of equipment that could be used to compromise the security of such systems.

| DESCRIPTION  | CATALOG NO.                     | PRICE   |
|--|---------------------------------|---------|
| <b>140 SERIES BOTTOM PINS</b>  |                                 |         |
| A2 Bottom pins (except for 6140, 6440, & 6540 RC, and KIK cylinders)     | A2A0 thru A2A9                  | 20.00   |
| A2 Bottom pins for 6140 & 6540 RC, and KIK cylinders                     | A2J0 thru A2J9                  | 20.00   |
| A4 Bottom pins (except for 6140, 6440, & 6540 RC, and KIK cylinders)     | A4E0 thru A4E5                  | 20.00   |
| A4 Bottom pins for 6140 & 6540 RC, and KIK cylinders                     | A4K0 thru A4K5                  | 20.00   |
| A2 Bottom pins for 6440 removable cores                                  | A2X0 thru A2X9                  | 20.00   |
| <b>140 SERIES TOP PINS</b>   |                                 |         |
| A2 Top pins for all products (except 6440 removable core)                | Use BEST top pins (see page 20) | N/A     |
| A4 Top pins for all products (except 6440 removable core)                | Use BEST top pins (see page 20) | N/A     |
| A2 Top pins for 6440 removable core                                      | A2W2 thru A2W19                 | 20.00   |
| <b>PATENT TOP &amp; BOTTOM PINS</b>                                      |                                 |         |
| Patent top pins for all IC and RC cylinders                              | PT1                             | 56.00   |
| Patent top pins for KIK cylinders  | PT2                             | 56.00   |
| Patent bottom pins (except for 6140, 6440, & 6540 RC, and KIK cylinders) | PB1                             | 56.00   |
| Patent bottom pins for 6140 & 6540 RC, and KIK cylinders                 | PB2                             | 56.00   |
| <b>TIMING PINS</b>   |                                 |         |
| Timing pin for 6340 and 6540 RC cylinders                                | TP6312                          | 57.00   |
| <b>SEGMENT SPRINGS</b>   |                                 |         |
| Springs for all products except Schlage 6440 RC                          | SS4220                          | 77.00   |
| Springs for Schlage 6440 RC  | SS4010                          | 77.00   |
| <b>SPRING SLIDE COVERS</b>   |                                 |         |
| Spring cover for all KIK cylinders and 6440 RC                           | SC2000                          | 57.00   |
| Spring cover for 6140 & 6240 RC, mortise, and rim cylinders              | SC2005                          | 57.00   |
| Spring cover for 6340 and 6540 RC cylinders                              | SC2001                          | 57.00   |
| Caps for 3840 IC core  | Use BEST 21C caps (see page 20) | N/A     |
| <b>CAPPING TOOLS</b>   |                                 |         |
| Staking fixture for KIK, mortise, and rim cylinders                      | CD4000                          | 581.00  |
| Staking fixture for IC, and all RC cylinders (except 6440 RC)            | CD6840                          | 581.00  |
| Staking tool for KIK, and all RC cylinders (except 6440 RC)              | CD4001                          | 273.00  |
| Staking fixture for 6440 RC cylinder                                     | CD6440                          | 292.00  |
| Staking tool for 6440 RC cylinder  | CD6401                          | 273.00  |
| Plug follower  | LT370                           | 48.00   |
| 140 & 150 key gage for both A2 and A4                                    | AD4050                          | 75.00   |
| <b>PIN KITS</b>  |                                 |         |
| Peaks universal A2 pin kit complete (Manufactured by KABA)               | CD5012                          | 1480.00 |
| Peaks universal A4 pin kit complete (Manufactured by KABA)               | CD5004                          | 1480.00 |
| Peaks Schlage 6440 RC A2 pin kit complete (Manufactured by KABA)         | CD5002                          | 1480.00 |
| <b>AD SERIES - KEY EQUIPMENT (You must purchase directly from Best)</b>  |                                 |         |
| Key combinator – Peaks® 6-pin  | AD436*                          | 6705.00 |
| Key combinator – Peaks® 7-pin  | AD437*                          | 6705.00 |
| Key carriage – Peaks® 6-pin  | AD436K                          | 1112.00 |
| Key carriage – Peaks® 7-pin  | AD437K                          | 1112.00 |
| <b>CAPPING TOOLS (You must purchase directly from Best)</b>              |                                 |         |
| 140 Series IC Capper/Decapper press                                      | CD517P                          | 2914.00 |
| 140 IC Capping block only (order CD540 for 150 IC)                       | CD540P                          | 218.00  |
| 140 & 150 Key cut indicator (Peaks equipment)                            | AD4050                          | 75.00   |
| 140 & 150 IC Capping tool (for use with capping block)                   | CD547                           | 29.00   |

All 140 Series keys and 150 Series keys using B3 through B6 keyways require a key milling machine.

\*Specify A2 or A4 keying system.



## KRD Series Key Retaining Devices

### How To Order

| KRD-2       | UL-KRD-2    | S      |
|-------------|-------------|--------|
| Device type | Part number | Option |

| DESCRIPTION                             | CATALOG NUMBER     | PRICE  |
|---|--------------------|--------|
| <b>BEST core models</b>                 |                    |        |
| KRD-2 BEST Core Model                   | UL-KRD-2           | 488.00 |
| KRD-2H Hybrid (Sargent/BEST Model)      | UL-KRD-2H SAR/BEST | 559.00 |
| KRD-2H Hybrid (BEST/Schlage FSIC Model) | UL-KRD-2H BEST/SCH | 559.00 |
| KRD-3 BEST Core Dual Function Model     | UL-KRD-3           | 723.00 |
| <b>Non-BEST Full size core models</b>   |                    |        |
| KRD-2 Corbin Russwin 6-pin IC           | UL-CR6-KRD-2       | 559.00 |
| KRD-2 Corbin Russwin 7-pin IC           | UL-CR7-KRD-2       | 559.00 |
| KRD-2 Medeco IC                         | UL-MED-KRD-2       | 559.00 |
| KRD-2 Sargent RC                        | UL-SAR-KRD-2       | 559.00 |
| KRD-2 Schlage FSIC                      | UL-SCH-KRD-2       | 559.00 |
| KRD-2 Yale 6-pin IC                     | UL-YA6-KRD-2       | 559.00 |
| KRD-2 Yale 7-pin IC                     | UL-YA7-KRD-2       | 559.00 |

| EXTRA COST OPTIONS* | OPTION CODE | ADD-ON |
|---------------------|-------------|--------|
| Switch              | S           | 173.00 |
| Security seal       | SS          | 155.00 |

\*Add option code to part number shown above.



## QU-I.C-SYSTEM Combining Tool Packages

### How To Order

|                  | <b>BQDP</b>   | <b>A2</b>                        | <b>7</b>               | <b>Example: GM 8301836 CTL 4189250</b>                        |
|------------------|---|----------------------------------|------------------------|---|
|                  | Package description   | System Type                      | Core size              | System Code Information REQUIREMENT                           |
| <b>Dedicated</b> | BQDP – Basic QU-I.C-KEY Dedicated Package<br>PQDP – Professional QU-I.C-KEY Dedicated Package | A2 – A2 System<br>A4 – A4 System | 6 – 6-pin<br>7 – 7-pin | YES<br>System Grand Master and Control codes must be supplied |
| <b>Universal</b> | BQUP – Basic QU-I.C-KEY Universal Package<br>PQUP – Professional QU-I.C-KEY Universal Package | A2 – A2 System<br>A4 – A4 System | 6 – 6-pin<br>7 – 7-pin | NO<br>Code information is not necessary.                      |

| DESCRIPTION  | CATALOG NO.               | PRICE |
|--|---------------------------|-------|
| <b>Dedicated Packages</b>  |                           |       |
| These QU-I.C-KEYS are permanently factory built specifically for just one key system. Grand master & Control codes are required. These tools are intended for long-term use by Institutional Locksmiths and others who continuously work with the same key system(s).            |                           |       |
| Basic dedicated package, includes: QKD, QLT-6 or QLT-7, QTT, QCT, QTJ, and QPT (see individual components listed below).   | BQDP-A2/A4-pin/GM & CTL * | 1898  |
| Professional dedicated package, includes all components in the basic package, plus QTA, QPP and CKT-80 (see individual components listed below).   | PQDP-A2/A4-pin/GM & CTL * | 2375  |
| <b>Universal Packages</b>  |                           |       |
| Using a blank QU-I.C-KEY and code strips, you get to custom build a QU-I.C-KEY for any A2 key system that you are working with. These kits are better suited for temporary use and re-use - not for longer term of continuous key system use. A4 System kits are also available. |                           |       |
| Basic universal package, includes: QKD, QLT-6 or QLT-7, QTT, QCT, QTJ, and QPT (see individual components listed below).   | BQUP-A2/A4-pin *          | 2378  |
| Professional universal package, includes all components in the basic package, plus QPP, QTA and CKT-80 (see individual components listed below).   | PQUP-A2/A4-pin *          | 2849  |
| <b>Individual Components</b>   |                           |       |
| Dedicated QU-I.C-KEY with viewing base (system information required)   | QKD-A2/A4-pin/GM & CTL    | 612   |
| Dedicated QU-I.C-KEY tool only (system information required)   | QKDT-A2/A4-pin/GM & CTL   | 463   |
| Universal QU-I.C-KEY with viewing base (specify A2 or A4 system)   | QKU-A2/A4                 | 1132  |
| QU-I.C-LOAD tool (specify 6 or 7-pin cores)  | QLT-6 * or QLT-7 *        | 471   |
| QU-I.C-TEST tool   | QTT *                     | 649   |
| QU-I.C-CHEX Tool   | QCT *                     | 109   |
| QU-I.C-Tweez-jector  | QTJ                       | 175   |
| QU-I.C-Preamer   | QPT                       | 148   |
| QU-I.C-Power preamer   | QPP                       | 109   |
| QU-I.C-TEST Adapter (must be used with QTT)  | QTA                       | 248   |
| 12 Position Core & key tray  | CKT-12                    | 213   |
| 80 Position Core & key tray  | CKT-80                    | 442   |

\*Not compatible with the special 140 Series.



## E Series Cylinders

### How To Order

| 1E           | 7   | 4             |   | C4  | RP3   | 626  |
|--------------|---|---------------|---|---|---|--|
| Series       | Core Housing  | Function Code | Length Code   | Cam or Spindle  | Rings   | Finish   |
| See Below*** | 0 – Dummy<br>6 – 6-pin<br>7 – 7-pin housing; accepts all BEST cores | See below     | Blank – Standard<br>22 – 1-3/8"<br>24 – 1-1/2"<br>up to 6"<br>(See length code below) | C4 – Standard cam<br>C181 – Adams Rite MS cam<br>S2 – Standard spindle<br>For a complete list of cams, see the next page. | RP – Rim cylinder<br>RP1 – Tapered cylinder<br>RP2 – 6-pin mortise<br>RP3 – 7-pin mortise<br>RP4 – 3E mortise<br>RP5 – 7-pin mortise<br>For special rings, see the catalog. | 626 690<br>Satin*<br>606 612<br>613 619<br>Bright*<br>605 611<br>625 |

\*Indicates extra cost; see below.

Must specify keymark and number of keys or designate L/C for less core.

\*\*\*1E Special Lengths only available on 1E4 7-Pin

| SERIES/DESCRIPTION   | FUNCTION OR LENGTH CODE | COMPLETE WITH COMBINATED CORE |         |          | LESS CORE |
|--|-------------------------|-------------------------------|---------|----------|-----------|
|  |                         | PATENTED*                     | PREMIUM | STANDARD |           |
| <b>1-5/32" DIAMETER CYLINDERS</b>                                      |                         |                               |         |          |           |
| 12E Standard rim   | 2                       | 146.00                        | 146.00  | 134.00   | 64.00     |
| 1E Standard mortise  | 4                       | 156.00                        | 156.00  | 144.00   | 74.00     |
| 1E Tapered mortise   | 6                       | 156.00                        | 156.00  | 144.00   | 74.00     |
| Dummy rim / mortise (0-pin**)  | 02/04                   | N/A                           | N/A     | N/A      | 40.00     |
| 1EA Turn knob-rim / mortise (6-pin**)                                  | A2/A4                   | N/A                           | N/A     | N/A      | 55.00     |
| 1EB Rim / mortise with dust cover                                      | B2/B4                   | 194.00                        | 194.00  | 182.00   | 112.00    |
| 1EC Square head mortise  | C4                      | 194.00                        | 194.00  | 182.00   | 112.00    |
| 1ED Slabbed direct motion (7-pin**)                                    | D4                      | 194.00                        | 194.00  | 182.00   | 112.00    |
| 1EE Slabbed lost motion (7-pin**)<br>(Specify RH or LH hand.)          | E4                      | 194.00                        | 194.00  | 182.00   | 112.00    |
| 1EF Standard lost motion (Note 1)                                      | F4                      | 194.00                        | 194.00  | 182.00   | 112.00    |
| 1EG Hotel shifting cam   | G4                      | 194.00                        | 194.00  | 182.00   | 112.00    |
| 1EJ High security—UL-listed (7-pin**)                                  | J4                      | 282.00                        | N/A     | 275.00   | N/A       |
| 1EK High security—Non-UL (7-pin**)                                     | K4                      | 187.00                        | N/A     | 181.00   | 192.00    |
| <b>1E SERIES SPECIAL LENGTH MORTISE CYLINDERS</b>                      |                         |                               |         |          |           |
| 1-3/8"   | 22                      | 181.00                        | 181.00  | 169.00   | 99.00     |
| Each additional 1/8" (1-1/2" to 6") See catalog for lengths available. | 24 to 96                | 4.80                          | 4.80    | 4.80     | 4.80      |
| <b>3E SERIES</b>   |                         |                               |         |          |           |
| Mortise-1-1/2" diameter (7-pin**)                                      | 4                       | 194.00                        | 194.00  | 182.00   | 112.00    |

| LENGTH CODE | CYLINDER LENGTH |
|-------------|-----------------|
| 22          | 1 3/8"          |
| 24          | 1 1/2"          |
| 26          | 1 5/8"          |
| 28          | 1 3/4"          |
| 30          | 1 7/8"          |
| 32          | 2"              |
| 34          | 2 1/8"          |
| 36          | 2 1/4"          |
| 40          | 2 1/2"          |
| 44          | 2 3/4"          |
| 48          | 3"              |
| 56          | 3 1/2"          |
| 64          | 4"              |
| 72          | 4 1/2"          |
| 80          | 5"              |
| 88          | 5 1/2"          |
| 92          | 5 3/4"          |
| 94          | 5 7/8"          |
| 96          | 6"              |

\*Patented pricing shown is for CORMAX patented keying. Add \$20.00 for BEST Preferred patented keying.

\*\*Only Standard and CORMAX M Series keying available on 1EJ and 1EK cylinders.

| *EXTRA COST OPTION                | ADD-ON |
|-----------------------------------|--------|
| Satin finish—606, 612, 613, etc.  | 3.80   |
| Bright finish—605, 611, 625, etc. | 5.40   |

| PART DESCRIPTION                  | PART NUMBER   | PART PRICE | WITH LOCK ADD-ON |
|-----------------------------------|---------------|------------|------------------|
| Standard rings                    | 1ER2, 3, 4, 5 | 4.80       | 0.00             |
| Straight rings (Specify lengths.) | 1ER7          | 18.00      | 7.20             |
| Tapered rings (Specify lengths.)  | 1ER8          | 22.00      | 17.00            |
| Security rings (Specify lengths.) | 1ESR          | 72.00      | 0.00             |
| Spindles                          | 1ES2, 3       | 4.80       | 0.00             |
| Hex nut for 1E                    | A00836        | 4.30       | 0.00             |
| Standard throw pins               | A40095        | 1.10       | 0.00             |
| Throw pins—Adams Rite MS Cam      | A20924        | 1.10       | 0.00             |

NOTE 1: Specify stop pin right or left of cam from back view.



## E Series Cylinders (continued)

Use the following table to determine the kinds of cams available for 1E, 3E and 5E cylinders.

### CAMS LISTING

| Cam Type   | Cams by Cylinder Type  |                                 |   |
|------------|--|---------------------------------|---|
|            | 1E Cyl   | 3E Cyl                          | 5E Cyl  |
| Cabinet    | C224 C225 C228<br>C229 C235 C238 C241<br>C246 C248 C249 C250<br>C253 C500 thru C509 (C500, C501, C502, etc)<br>A04607 A08854 A10281 A14154   |                                 | C2A C245<br>C4A C3<br>C2B C4B<br>A10281<br>A21198<br>A26344 |
| Cloverleaf | C118 C161 C204 C222<br>C243 C254 C256 C258<br>C265 C281  | C118 C161                       |   |
| Roller     | C142 C221 C227<br>C240 C251 A04533   | A04533                          |   |
| Straight   | C101 C103 C110 C115 C121 C123 C124<br>C127 C128 C129 C130 C131 C134 C136<br>C137 C143 C148 C152 C162 C165 C169<br>C171 C173 C177 C178 C179 C181 C182<br>C185 C186 C187 C191 C193 C200 C203<br>C208 C209 C210 C211 C220 C223 C226<br>C231 C233 C234 C239 C242 C247 C252<br>C4 | C127 C136<br>C208 C210<br>C3 C4 |   |
| Thumbturn  | C140 C410 thru (C401, C402, etc)   |                                 |   |
| Two-point  | C102 C114  |                                 |   |

Consult factory for pricing on cams.





## 5E and 8E Series Utility Cylinders (Cam Locks)

### How To Order

| 5E        | 7                      | A  | 1                              | C  | R708   | 4B   | 21   | 12   | R                     | 90                                   | 626      |
|-----------|------------------------|--|--------------------------------|--|--|--|--|--|-----------------------|--------------------------------------|----------|
| Series    | Lock Body              | Keyway                                   | Combining Code                 | Cam Motion   | Ring Length  | Cam Type*  | Cam Length   | Mounting Position  | Cam Direction         | Degree of Rotation                   | Finish   |
| 5E – 3/4" | 6 – 6-pin<br>7 – 7-pin | Designate specific keyway (A, E, etc.)** | 1 – Uncombined<br>2 – Combined | A – Direct<br>B – Limited<br>C – Lost motion<br>D – Throw member drive | R701 – 1/16"<br>R702 – 1/8"<br>R703 – 3/16"<br>R704 – 1/4"<br>R705 – 5/16"<br>R706 – 3/8"<br>R707 – 7/16"<br>R708 – 1/2"<br>etc. | 1 – Fixed Straight<br>2A – Fixed offset in<br>2B – Fixed offset out<br>3 – Lost motion<br>4A – Lost motion offset in<br>4B – Lost motion offset out<br>D – Direct throw member | 10 – 5/8"<br>12 – 3/4"<br>14 – 7/8"<br>16 – 1"<br>and so forth in 16ths of an inch | 3 – 3 o'clock<br>6 – 6 o'clock<br>9 – 9 o'clock<br>12 – 12 o'clock | R – Right<br>L – Left | 90 – 90°<br>180 – 180°<br>360 – 360° | 626 Only |

\*See the previous page for other compatible 5E cams.

If combined, you must specify keymark and number of keys.

\*\*5E cylinders available in Standard and Premium keyways only.

| DESCRIPTION   | COMBINATING CODE | PRICE COMPLETE |
|---------------|------------------|----------------|
| 5E—Uncombined | 1                | 71.00          |
| 5E—Combined   | 2                | 94.00          |

| PART DESCRIPTION        | PART NUMBER | PART PRICE |
|-------------------------|-------------|------------|
| Cams                    | 5EC1, etc.  | 5.70       |
| Slide cap—6-pin         | 5ECP6       | 1.30       |
| Slide cap—7-pin         | 5ECP7       | 1.30       |
| Cam screws              | 5ECS        | 2.50       |
| Hex nut 3/4"            | 5EH         | 4.80       |
| Cam screw lock washer   | 5ELW        | 2.50       |
| Rings (Specify length.) | 5ER7        | 6.60       |
| Springs (box of 500)    | 5ES1        | 39.00      |
| Lock body washer        | 5EW         | 2.50       |

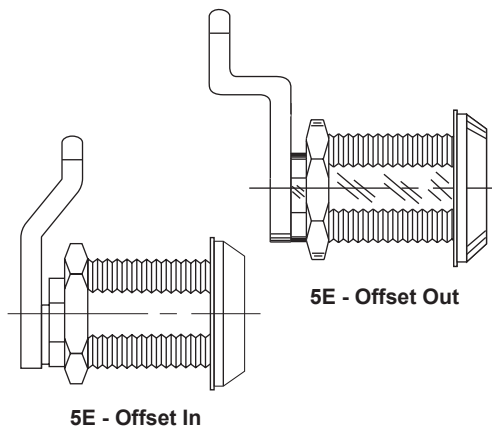

| DESCRIPTION                       | CATALOG NUMBER | COMPLETE WITH COMBINATED CORE |         |          | LESS CORE |
|-----------------------------------|----------------|-------------------------------|---------|----------|-----------|
|                                   |                | PATENTED*                     | PREMIUM | STANDARD |           |
| <b>8E SERIES EUROCYLINDERS</b>    |                |                               |         |          |           |
| Single cylinder—elliptical***     | 8EA7A5         | N/A                           | N/A     | 172.00   | 100.00    |
| Double cylinder—elliptical***     | 8EA7A6         | N/A                           | N/A     | 264.00   | 120.00    |
| Single cylinder—profile****       | 8EE7E4         | N/A                           | N/A     | 264.00   | 192.00    |
| Double cylinder—profile****       | 8EE7E5         | N/A                           | N/A     | 350.00   | 206.00    |
| Cylinder x turn knob—profile***** | 8EE7E8         | N/A                           | N/A     | 264.00   | 192.00    |
| Union single cylinder*****        | 8EH7H5         | 240.00                        | 240.00  | 228.00   | 158.00    |
| Union double cylinder*****        | 8EH7H6         | 367.00                        | 367.00  | 343.00   | 203.00    |
| Union cylinder x turn knob*****   | 8EH7H7         | 260.00                        | 260.00  | 248.00   | 178.00    |
| Union cylinder x lever turn*****  | 8EH7H8         | 325.00                        | 325.00  | 313.00   | 243.00    |

\*To order 8EE7E5, you must specify the ring length and critical dimensions. Refer to the catalog section "Cylinders."

\*\*Patented pricing shown is for CORMAX patented keying system. Add \$20.00 for BEST preferred patented keying.

\*\*\*Available in 605,606,619,625,626 finishes

\*\*\*\*Available in 606,613,619,626 finishes

\*\*\*\*\*Available in 606,625,626 finishes

ATTENTION: Locksets that secure both sides of the door are controlled by building codes and the Life Safety Code. Delay in unlocking for rapid emergency exit could be hazardous or even fatal.



# Keystone® Web

| DESCRIPTION  | PRODUCT NUMBER | LIST PRICE |
|--|----------------|------------|
| Keystone Web – New License   | KSWN           | 4,355.40   |
| Keystone Web – Upgrade (For existing users with Keystone 600 software) | KSWUP          | 2,177.70   |

| DESCRIPTION  | PRODUCT NUMBER | LIST PRICE |
|--|----------------|------------|
| Complete System Import - Importing code files for an entire masterkey system(s)                              | IMPKSW-1       | 871.08     |
| Additions Import * – Importing code files for additions to existing system (Imports of less than 10 masters) | IMPKSW-2       | 217.77     |

\*Any additions import consisting of more than 10 masters will require IMPKSW-1  
 The import pricing is without respect to how many individual masterkey systems or code files are imported  
 Every import order must be accompanied by an import order form. The import form is located on [bestaccess.com](http://bestaccess.com) under Keystone web resources or ask your dormakaba USA sales representatives for a copy.

Notes: Keystone Web software will support both network and standalone installations  
 Keystone Web comes without any information loaded. Code Import files have to be ordered to import code data  
 For existing customers, migration tool is included with the software to migrate data into the new application during upgrade.  
 There is no additional charge for migrating existing user data in older version of Keystone to Keystone Web.  
 All orders will require following information: End User Company/Facility Name, End User Name, End User Email.



# 45H Series Mortise Locks

Federal Spec. 86

ANSI Series 1000

## How To Order

| 45H                         | 7   | R   | 14   | H   | 626  | RH                     |   |
|-----------------------------|---|---|--|---|--|------------------------|---|
| Series                      | Core Housing  | Function Code   | Lever Style  | Trim Style  | Finish   | Door Hand              | Options   |
| 45H – Standard mortise lock | 0** – Less cylinder (non-keyed or dummy trim)<br>7 – 7-pin housing accepts all BEST cores | A – Office<br>D – Storeroom<br>L – Privacy<br>N – Passage<br>R – Classroom<br>T – Dormitory etc.<br>See below | 3 – Solid tube/return<br>12* – Solid tube/no return<br>14 – Curved/return<br>15 – Contour/angle return<br>16 – Curved/no return<br>17R* – Gull wing RH<br>17L* – Gull wing LH<br>Knobs:<br>4 – Round<br>Decorative*<br>50-91<br>OEM - Service (less lever)** | H – 2-3/4" dia.<br>R – 2-3/4" dia.<br>S – 3-1/2" dia<br>J* – wrought<br>M* – forged<br>N* – forged<br>(concealed cylinder;<br>N trim invalid on non-keyed and double keyed functions) | 618 626 630*<br>690 622<br>626AM* 630AM*<br>Satin*<br>606 612<br>613 619<br>Bright*<br>605 611<br>625 629* | RH<br>RHR<br>LH<br>LHR | 7/8"* – 7/8" lip-to-center strike<br>LL* – Lead lined<br>SH* – Security head screws<br>Thick Door* – Specify thickness if other than 1-3/4"<br>TAC/B* – Tactile both levers/knobs<br>TAC/O* – Tactile outside lever/knob<br>TAC/I* – Tactile inside lever/knob<br>VIN* – Visual Keyed Indicator<br>Option<br>VIT* - Visual Thumb-Turn Indicator<br>Option<br>VIB* -Double Visual Indicator<br>Option<br>VT* - Vandal Trim<br>WS – Windstorm Label (NOA Miami-Dade County) |

\*Indicates extra cost option

\*\*Indicates cost deduction. Must specify keymark and number of keys or designate L/C for less core.

NOTE: VIN option only compatible with H, R and J trim styles

VIT options only compatible with H, R, S, J & M trim styles

VIB option only compatible with H, R & J trim styles

OEM option is only compatible with H, R and S Trim Styles.

Decorative levers are considered special order items that may have extended lead times. Consult factory for lead times.

Available decorative levers: 50-53, 55, 60, 62-63, 65, 69, 75, 79-81, and 89

Universal locks can only be ordered with sectional (rose) trim. If escutcheon (J/M/N) trim is needed, order a three-part lock

| FUNCTION DESCRIPTION       | FUNCTION CODE            | COMPLETE WITH COMBINATED CORE |         |          | LESS CORE |
|----------------------------|--------------------------|-------------------------------|---------|----------|-----------|
|                            |                          | PATENTED*                     | PREMIUM | STANDARD |           |
| <b>Single Keyed:</b>       |                          |                               |         |          |           |
| Latch                      | A, AT, D, R              | 978.00                        | 978.00  | 966.00   | 896.00    |
| Deadbolt                   | AB, B, BA, BW, T, TA, TD | 1005.00                       | 1005.00 | 993.00   | 923.00    |
| Holdback                   | RHB                      | 995.00                        | 995.00  | 983.00   | 913.00    |
| Hotel                      | H, HJ                    | N/A                           | N/A     | 1106.00  | 1036.00   |
| Deadlock                   | AD, YD                   | 443.00                        | 443.00  | 431.00   | 361.00    |
| Deadlock-Classroom         | RD                       | 497.00                        | 497.00  | 485.00   | 415.00    |
| <b>Double Keyed:</b>       |                          |                               |         |          |           |
| Latch                      | C, INL, W                | 1140.00                       | 1140.00 | 1116.00  | 976.00    |
| Deadbolt                   | G, IND, S, INA           | 1170.00                       | 1170.00 | 1146.00  | 1006.00   |
| Holdback                   | CHB                      | 1170.00                       | 1170.00 | 1146.00  | 1006.00   |
| Deadlock                   | WD                       | 603.00                        | 603.00  | 579.00   | 439.00    |
| <b>Keyless:</b>            |                          |                               |         |          |           |
| Passage                    | N                        | N/A                           | N/A     | N/A      | 708.00    |
| Privacy (Latch)            | LT                       | N/A                           | N/A     | N/A      | 814.00    |
| Privacy (Deadbolt)         | L, LB                    | N/A                           | N/A     | N/A      | 837.00    |
| Exit                       | NX                       | N/A                           | N/A     | N/A      | 814.00    |
| Single Dummy               | 1DT                      | N/A                           | N/A     | N/A      | 307.00    |
| Double Dummy               | 2DT                      | N/A                           | N/A     | N/A      | 545.00    |
| <b>Universal Functions</b> |                          |                               |         |          |           |
| Latch                      | UNR**                    | 977.00                        | 977.00  | 965.00   | 895.00    |
| Deadbolt                   | UNT, UNAB**              | 995.00                        | 995.00  | 983.00   | 913.00    |

\*Patented pricing show is for CORMAX patented keying. Add \$20.00 for BEST Preferred patented keying.

\*\*Universal function locks can only be ordered with sectional trim.

NOTE: 47H Series must be keyed at the factory unless the K option is ordered.



## 45H Series Mortise Locks (continued)

| EXTRA COST OPTIONS*                               | OPTION CODE             | PER LOCK |
|---|-------------------------|----------|
| Satin finishes (per lock)                         | 606, 612, 613, 619 etc. | 31.00    |
| Bright finishes (per lock)                        | 605, 611, 625, etc.     | 59.00    |
| UltraShield antimicrobial finish                  | 626AM, 630AM            | 61.00    |
| Wrought trim                                      | J                       | 12.00    |
| Thick door  | Specify thickness       | 85.00    |
| Tactile both levers/knobs^                        | TAC/B                   | 120.00   |
| Tactile outside lever/knob^                       | TAC/O                   | 61.00    |
| Tactile inside lever/knob^                        | TAC/I                   | 61.00    |
| Lead lined  | LL                      | 233.00   |
| Forged trim                                       | M, N                    | 94.00    |
| Security head screws                              | SH                      | 22.00    |
| 7/8" Lip-to-center strike                         | 7/8 LTC                 | 22.00    |
| Vandal trim - 630 finish^                         | VT                      | 149.00   |
| Vandal trim - other finishes^                     | VT                      | 114.00   |
| Visual Indicator^                                 | VIN                     | 44.00    |
| Visual Indicator Thumb-Turn                       | VIT                     | 69.00    |
| Double Visual Indicator                           | VIB                     | 113.00   |
| 12, 17 Lever Design                               | 12, 17                  | 66.00    |
| Decorative Lever Design                           | 50-53, 55, 60, etc.     | 211.00   |
| COST DEDUCTIONS**                                 | OPTION CODE             | DEDUCT   |
| Less cylinder option (Deduct from complete price) | 0                       | 61.00    |
| OEM - Service (Less lever/trim)^                  | OEM                     | 28.00    |

\*Indicates extra cost option.

\*\*Indicates cost deduction. Must specify keymark and number of keys or designate L/C for less core.

^NOTE:

TAC/B, TAC/O, TAC/I options not available on #17 levers.

Vandal trim option available only with #14 and #15 levers. Only #14 lever complies with California State Fire Marshal Code.

VIN option only compatible with H, R and J Trim Styles.

OEM Service: The BEST BHMA listed lock with trim from another manufacturer in this price book is not being offered as a BHMA listed product. dormakaba USA cannot ensure the compatibility of our lock with any third party product and such products have not been tested as a combined unit. Please see warranty for further details.



## 47H Series High Security Mortise Lock

Federal Spec. 86

ANSI Series 1000

### How To Order

| 47H  | 7                                      | R   | 14   | M   | 626                            | RH                     |  |
|--|--|---|--|---|--------------------------------|------------------------|--|
| Series   | Core Housing                           | Function Code   | Lever Style  | Trim Style  | Finish                         | Door Hand              | Options  |
| 47H – Lever/ Knob - High Security mortise lock | 7 – 7-pin housing accepts 5C core only | A – Office<br>D – Storeroom<br>R – Classroom<br>T – Dormitory<br>etc. | Levers:<br>3 – Solid tube/return<br>12* – Solid tube/no return<br>14 – Curved/return<br>15 – Contour/angle return<br>16 – Curved/no return<br>17* – Gull wing<br>Knobs:<br>4 – Round<br>Decorative*<br>50–91 | H*** – 2-3/4" dia<br>R*** – 2-3/4" dia<br>S*** – 3-1/2" dia<br>M – Forged | 626<br>630<br>626AM*<br>630AM* | RH<br>RHR<br>LH<br>LHR | 7/8"* – 7/8" Lip-to-center strike<br>K – Non UL cylinder<br>LL* – Lead lined<br>TAC/B* – Tactile both levers/knobs<br>TAC/O* – Tactile outside lever/knob<br>TAC/I* – Tactile inside lever/knob<br>Thick Door* – specify thickness if other than 1 3/4"<br>VT* – Vandal Trim<br>WS – Windstorm Label (NOA Miami-Dade County) |

EXTRA COST OPTIONS\* See 45H section.

\*\* Indicates cost deduction; see 45H section. Must specify keymark and number of keys.

\*\*\*To maintain the UL437 standard for high security locks, order only M trim. Using H, R or S trim does not meet the UL437 standard.

NOTE: Decorative levers are considered special order items that may have extended lead times. Consult factory for lead times.

Available decorative levers: 50-53, 55, 60, 62-63, 65, 69, 75, 79-81, and 89

| FUNCTION DESCRIPTION | FUNCTION CODE            | PATENTED* | STANDARD |
|----------------------|--------------------------|-----------|----------|
| <b>Single Keyed:</b> |                          |           |          |
| Latch                | A, AT, D, R              | 1195.00   | 1188.00  |
| Deadbolt             | AB, B, BA, BW, T, TA, TD | 1230.00   | 1223.00  |
| Deadlock             | AD, YD                   | 746.00    | 739.00   |
| Deadlock-Classroom   | RD                       | 804.00    | 797.00   |
| <b>Double Keyed:</b> |                          |           |          |
| Latch                | C, INL, W                | 1461.00   | 1447.00  |
| Deadbolt             | G, IND, S, INA           | 1503.00   | 1489.00  |
| Deadlock             | WD                       | 1025.00   | 1011.00  |

\*Pricing reflects the 5C high security core for standard, and the 5CM high security CORMAX core for patented.



## 48H and 49H Series Mortise Deadlocks

### How To Order

| 48H                                     | 7   | K             | 626   | Options  |
|---|---|---------------|---|--|
| Series                                  | Core Housing  | Function Code | Finish  |  |
| 48H – Standard<br>49H** – High security | 0 – Less cylinder (48H only)<br>7 – 7-pin housing<br>48H accepts all BEST cores<br><br>49H accepts 5C core only | See below     | 622 626<br>690<br>626AM*<br>Satin*<br>606 612<br>613 619<br>Bright*<br>605 611<br>618 625<br>49H<br>626 630 | K – 1E7K4 high security cylinder (non UL) for 49H only<br>LL* – Lead lined<br>SH* – Security head screws<br>Thick Door* – Specify thickness if other than 1-3/4”<br>WS – Windstorm Label (NOA Miami-Dade County) |

\*Indicates extra cost option; see below.  
 \*\*49H is keyed at the factory unless the K option is ordered.  
 NOTE: Must specify keymark and number of keys or designate L/C for less core.  
 Security Head screws provided standard on 49H.

| FUNCTION DESCRIPTION        | FUNCTION CODE | COMPLETE WITH COMBINATED CORE |         |          | LESS CORE |
|-----------------------------|---------------|-------------------------------|---------|----------|-----------|
|                             |               | PATENTED*                     | PREMIUM | STANDARD |           |
| <b>48H SERIES</b>           |               |                               |         |          |           |
| Single cylinder             | K, L          | 439.00                        | 439.00  | 427.00   | 357.00    |
| Single cylinder - Classroom | R**           | 492.00                        | 492.00  | 480.00   | 410.00    |
| Double cylinder             | M             | 594.00                        | 594.00  | 570.00   | 430.00    |
| <b>49H SERIES</b>           |               |                               |         |          |           |
| Single cylinder             | K, L          | 832.00                        | N/A     | 825.00   | N/A       |
| Single cylinder-Classroom   | R**           | 889.00                        | N/A     | 882.00   | N/A       |
| Double cylinder             | M             | 997.00                        | N/A     | 990.00   | N/A       |

\*For 48H, patented pricing shown is for CORMAX M series patented keying system only. Add \$20.00 for BEST Preferred Keying.  
 For 49H, pricing reflects the 5C high security core for standard and the 5CM high security CORMAX core for patented.  
 \*\*Handing (LH or RH) must be specified when ordering a “R” function. Indicate “LH” for LH/LHR door handing and “RH” for RH/RHR door handing.

| EXTRA COST OPTIONS*              | OPTION CODE         | ADD-ON |
|----------------------------------|---------------------|--------|
| Satin finishes                   | 606, 612, 613, etc. | 31.00  |
| Bright finishes                  | 605, 611, 625, etc. | 59.00  |
| UltraShield antimicrobial finish | 626AM, 630AM        | 61.00  |
| Security head screws (48H)       | SH                  | 22.00  |
| Thick door (48H only)            | Specify thickness   | 85.00  |
| Lead lined                       | LL                  | 233.00 |



## 40H Series Mortise Components

Federal Spec. 86

ANSI Series 1000

### How To Order Case Only

| 45HCA                          | R   | 626  |   |
|--------------------------------|---|--|---|
| Series                         | Function Code   | Finish   | Options   |
| 45HCA - Mortise lock case only | A - Office<br>D - Storeroom<br>R - Classroom<br>T - Dormitory<br>etc. | 626 630<br>622 690<br>626AM*<br>630AM*<br><br>Satin*<br>606 612<br>613 619<br>618<br><br>Bright*<br>605 611<br>625 629 | SH* - Security head screws 7/8" - 7/8"<br>Lip-to-center strike (Handling): RH<br>LH<br>RHR<br>LHR |

\*Indicates extra cost option.

### How To Order Trim Kits

| 40HTK            | OS2  | 14  | H  | 626   |   |
|------------------|--|---|--|---|---|
| Series           | Function Code  | Knob/Lever Style  | Trim Style   | Finish  | Options   |
| 40HTK - Trim Kit | IS1 - inside lever only<br>IS2 - inside lever x turn<br>IS3 - inside lever x cyl<br>IS4 - inside cyl only<br>IS5 - inside turn only***<br>IS6 - inside lever x cylinder x visual indicator<br>OS1 - outside lever only<br>OS2 - outside lever x cyl<br>OS3 - outside lever/ emergency plate<br>OS4 - outside cyl only<br>OS5 - outside lever x visual indicator<br>OS6 - outside lever x cylinder x visual indicator | Levers:<br>3-solid tube/return<br>12* - Solid tube/no return<br>14-curved return<br>15-contour/angle return<br>16-curve/no return<br>17-RH*<br>17-LH*<br>50-91 - Decorative*<br><br>Knobs:<br>4-round | H-2-3/8" dia.<br>R-2-3/4" dia.<br>S-3-1/2" dia<br>J*-wrought<br>M*-forged<br>N*-forged<br>(concealed cylinder) | 605*<br>606*<br>611*<br>612*<br>613*<br>618*<br>619*<br>622<br>625*<br>626<br>629<br>630<br>690<br>626AM*<br>630AM* | Thick Door* (specify thickness if other than 1 3/4")<br>SH* - Security head screws<br>TAC/O* - Tactile outside lever/knob<br>TAC/I* - Tactile inside lever/knob |

\*\*\*Does not include lever - Unavailable with J trim.

| 45HCA CASE ONLY:           |                          |        |
|----------------------------|--------------------------|--------|
| FUNCTION DESCRIPTION       | FUNCTION CODE            | PRICE  |
| <b>Single Keyed:</b>       |                          |        |
| Latch                      | A, AT, D, R              | 382.00 |
| Deadbolt                   | AB, B, BA, BW, T, TA, TD | 414.00 |
| Holdback                   | RHB                      | 390.00 |
| Hotel                      | H, HJ                    | 414.00 |
| Deadlock                   | AD, YD                   | 263.00 |
| Deadlock-Classroom         | RD                       | 241.00 |
| <b>Double Keyed:</b>       |                          |        |
| Latch                      | C, INL, W                | 382.00 |
| Deadbolt                   | G, IND, S, INA           | 414.00 |
| Holdback                   | CHB                      | 390.00 |
| Deadlock                   | WD                       | 263.00 |
| <b>Keyless:</b>            |                          |        |
| Passage                    | N                        | 298.00 |
| Privacy (Latch)            | LT                       | 382.00 |
| Privacy (Deadbolt)         | L, LB                    | 414.00 |
| Exit                       | NX                       | 382.00 |
| <b>Universal Functions</b> |                          |        |
| Latch                      | UNR                      | 382.00 |
| Deadbolt                   | UNT, UNAB                | 414.00 |

Price includes lock case, faceplate and strike package. Refer to 45H for complete mortise cylinder pricing.

### Vandal Trim Retrofit Kit

| SERIES                   | LEVER STYLE  | FINISH  | OPTIONS   |
|--------------------------|--|---|---|
| 45HVTK - Vandal Trim Kit | 14* - curved return<br>15 - contour / angle return | 605, 606, 611, 612, 613, 618, 619, 622, 625, 626, 629, 630, 690 | Thick door (specify thickness if other than 1 3/4") |

| TRIM ONLY:                                       |        |
|--|--------|
| KIT NUMBER                                       | PRICE  |
| IS1 - Inside lever only                          | 210.00 |
| IS2 - Inside lever x turn                        | 278.00 |
| IS3 - Inside lever x cylinder                    | 301.00 |
| IS4 - Inside cylinder only                       | 84.00  |
| IS5 - Inside turn only                           | 74.00  |
| IS6 - Inside lever x cylinder x visual indicator | 345.00 |
| OS1 - Outside lever only                         | 234.00 |
| OS2 - Outside lever x cylinder                   | 312.00 |
| OS3 - Outside lever x emergency plate            | 245.00 |
| OS4-Outside cylinder only                        | 84.00  |
| OS5-Outside lever x Visual Indicator             | 278.00 |
| OS6-Outside lever x cylinder x visual indicator  | 356.00 |

| EXTRA COST OPTIONS*              | OPTION CODE         | ADD-ON |
|----------------------------------|---------------------|--------|
| Satin finishes                   | 606, 612, 613, etc. | 31.00  |
| Bright finishes                  | 605, 611, 625, etc. | 59.00  |
| UltraShield antimicrobial finish | 626AM, 630AM        | 61.00  |
| J Trim                           | J                   | 12.00  |
| Forged trim                      | M, N                | 94.00  |
| Thick Door                       | Specify Thickness   | 85.00  |
| Security head screws             | SH                  | 22.00  |
| 7/8" Lip-to-center strike        | 7/8" LTC            | 22.00  |
| Tactile outside lever/knob**     | TAC/O               | 61.00  |
| Tactile inside lever/knob**      | TAC/I               | 61.00  |
| 12, 17 Lever Design              | 12, 17              | 33.00  |
| Decorative Lever Design          | 50 to 91            | 105.50 |

| VANDAL TRIM KIT FINISH | PRICE  |
|------------------------|--------|
| 630                    | 173.00 |
| All others             | 132.00 |

\*\* Not available on #17 levers.





# 40H Strike Packages

Federal Spec. 86

ANSI Series 1000

## How To Order

| 40HST                  | 1   | 626   |   |
|------------------------|---|---|---|
| Series                 | Kit number  | Finishes  | Options   |
| 40HST – Strike package | 1 – Standard<br>4 - Strike Box Only<br>5 – Latchbolt only<br>6 – Latchbolt/deadbolt | 605 606<br>611 612<br>613 618<br>619 622<br>625 626<br>629 630<br>690 | Thick Door* – (specify thickness if other than 1-3/4")<br>7/8"* – 7/8" lip-to-center strike<br>SH* – Security head screws<br>RH - Handing (required for 5,6 kit)<br>LH - Handing (required for 5,6 kit) |

\*Indicates extra cost option.

| PART DESCRIPTION                  | PART NUMBER    | PARTS PRICE |
|-----------------------------------|----------------|-------------|
| <b>STRIKE PACKAGES</b>            |                |             |
| Standard strike package           | 40HST-1-626    | 40.00       |
| Latchbolt-only strike package     | 40HST-5-626-RH | 45.00       |
| Latchbolt/deadbolt strike package | 40HST-6-626-LH | 45.00       |
| <b>STRIKE PACKAGES</b>            |                |             |
| Plastic strike box                | 40HST-4        | 2.70        |
| Wrought steel strike box          | 3126903        | 7.20        |

| EXTRA COST OPTIONS*       | OPTION CODE       | ADD-ON |
|---------------------------|-------------------|--------|
| Thick door                | Specify thickness | 22.00  |
| 7/8" Lip-to-center strike | 7/8" LTC          | 22.00  |
| Security head screws      | SH                | 22.00  |

# 40H Lever Sets

## How To Order

| 40HLS             | 14  | 626   |  |
|-------------------|---|---|--|
| Series            | Knob/lever style  | Finishes  | Options  |
| 40HLS – Lever set | Levers:<br>3 – Solid tube/return<br>12* – Solid tube/no return<br>14 – Curved/return<br>15 – Contour/angle return<br>16 – Curved/no return<br>17* RH – Gull wing right hand<br>17* LH – Gull wing left hand<br>50-91 – Decorative*<br>Knobs:<br>4 – Round | 605 606<br>611 612<br>613 618<br>619 622<br>625 626<br>629 630<br>690<br>626AM*<br>630AM* | Thick door* – (specify thickness if other than 1-3/4")<br>SH* – Security head screws |

\*Indicates extra cost option.

\*\*Decorative lever design sets are not available.

| PART DESCRIPTION                         | PART NUMBER  | PARTS PRICE |
|--|--------------|-------------|
| <b>LEVER SETS</b>                        |              |             |
| 40H Lever Set #3 design                  | 40HLS -3     | 327.00      |
| 40H Lever Set #12 design                 | 40HLS -12    | 406.00      |
| 40H Lever Set #14 design                 | 40HLS-14     | 327.00      |
| 40H Lever Set #15 design                 | 40HLS-15     | 327.00      |
| 40H Lever Set #16 design                 | 40HLS-16     | 327.00      |
| 40H Lever Set #17 RH design              | 40HLS -17 RH | 406.00      |
| 40H Lever Set #17 LH design              | 40HLS -17 LH | 406.00      |
| 40H Decorative Lever Sets #50-91 designs | 40HLS -XX*   | 569.00      |
| 40H Knob Set #4 design                   | 40HLS-4      | 327.00      |

| EXTRA COST OPTIONS*              | OPTION CODE       | ADD-ON |
|----------------------------------|-------------------|--------|
| Thick Door                       | Specify Thickness | 22.00  |
| Security head screws             | SH                | 22.00  |
| UltraShield antimicrobial finish | 626AM, 630AM      | 61.00  |

\*Choose one decorative lever set design from #50-91



## 40H Replacement Spindles

Federal Spec. 86

ANSI Series 1000

### How To Order

| 40HRS                            | 2  |  |
|----------------------------------|--|--|
| Series                           | Kit number                                       | Options  |
| 40HRS – Replacement spindle kits | 2 – 40H Standard spindle<br>4 – 40H Hook spindle | Thick door* – Specify thickness if other than 1 3/4" |

\*Indicates extra cost option.

| PART DESCRIPTION            | PART NUMBER | PARTS PRICE |
|-----------------------------|-------------|-------------|
| <b>REPLACEMENT SPINDLES</b> |             |             |
| 40H Swivel spindle assembly | 40HRS-2     | 40.00       |
| 40H Hook spindle assembly   | 40HRS-4     | 74.00       |

| EXTRA COST OPTIONS* | OPTION CODE       | ADD-ON |
|---------------------|-------------------|--------|
| Thick door          | Specify Thickness | 22.00  |

## 40H Screw Kits

### How To Order

| 40HSK              | 1   | 626                       |  |
|--------------------|---|---------------------------|--|
| Series             | Kit number  | Finishes                  | Options  |
| 40HSK – Screw kits | 1 – H, R, S, J trim screw kit<br>2 – M, N trim screw kit<br>3 – Special purpose fasteners screw kit<br>4 – Surface-mounted trim screw kit<br>5 – Visual indicator screw kit | 606 612<br>613 622<br>626 | Thick door* – Specify thickness if other than 1 3/4"<br>SH* – Security head screws |

\*Indicates extra cost option.

| PART DESCRIPTION                    | PART NUMBER | PARTS PRICE |
|-------------------------------------|-------------|-------------|
| <b>SCREW KITS</b>                   |             |             |
| H, R, S, J trim screw kit           | 40HSK-1     | 27.00       |
| M, N trim screw kit                 | 40HSK-2     | 27.00       |
| Special purpose fasteners screw kit | 40HSK-3     | 27.00       |
| Surface-mounted trim screw kit      | 40HSK-4     | 27.00       |
| Visual indicator screw kit          | 40HSK-5     | 27.00       |

| EXTRA COST OPTIONS*  | OPTION CODE       | ADD-ON |
|----------------------|-------------------|--------|
| Thick door           | Specify Thickness | 22.00  |
| Security head screws | SH                | 22.00  |

## 40H Faceplate Kits

Federal Spec. 86

ANSI Series 1000

### How To Order

| 40HFP                 | 3   | 626   |                            |
|-----------------------|---|---|----------------------------|
| Series                | Kit number  | Finishes  | Options                    |
| 40HFP – Faceplate kit | 0 – for function: AB<br>1 – for functions: BW, TD, H, HJ<br>2 – for function: A<br>3 – for functions: AT, D, C, INL, NX, R, W<br>4 – for functions: N, LT<br>5 – for functions: AD, RD, YD, WD<br>6 – Blank with logo<br>7 – for functions: BA, S, TA<br>8 – for functions: B, G, IND, L, LB, T<br>9 – for functions: CHB, RHB<br>10 – Blank without logo | 605 606<br>611 612<br>613 618<br>619 622<br>625 626<br>629 630<br>690 | SH* – Security head screws |

\*Indicates extra cost option.

| PART DESCRIPTION       | PARTS PRICE |
|------------------------|-------------|
| <b>FACEPLATE KITS:</b> |             |
| All face plate kits    | 40.00       |

| EXTRA COST OPTIONS*  | OPTION CODE | ADD-ON |
|----------------------|-------------|--------|
| Security head screws | SH          | 22.00  |

## 40H Visual Indicator Thumb-Turn Kit

### How To Order

| 40HVIT | J  | 626   | 1-3/4"   |
|--------|--|---|--|
| Series | Trim Style   | Finishes  | Door Thickness   |
| 40HVIT | H - 2 3/4" Dia.<br>R - 2 3/4" Dia.<br>S - 3 1/2" Dia.<br>M - Forged<br>J - Wrought | 605 606<br>611 612<br>613 618<br>619 622<br>625 626<br>629 630<br>690<br>626AM * 630AM* | 1-3/4"<br>Thick door* - Specify thickness if other than 1-3/4" |

\*Indicates extra cost option.

NOTE: Thick Door option available for doors up to 5" thick

| PART DESCRIPTION                                       | PART NUMBER | PARTS PRICE |
|--|-------------|-------------|
| VISUAL INDICATOR THUMB-TURN                            |             |             |
| Sectional Visual Thumb-Turn Indicator (H, R & S Trims) | 40HVIT      | 124.00      |
| Escutcheon Visual Thumb-Turn Indicator (J & M Trims)   | 40HVIT      | 225.00      |

| EXTRA COST OPTIONS*              | OPTION CODE       | ADD-ON |
|----------------------------------|-------------------|--------|
| Thick door                       | Specify Thickness | 22.00  |
| Ultrashield Antimicrobial Finish | 626AM, 630AM      | 61.00  |

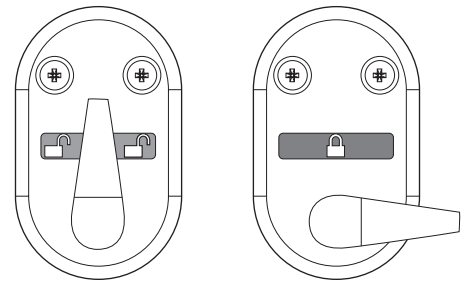

## 40H Indicator Laminate Kit

| PART DESCRIPTION                           | PART NUMBER | PARTS PRICE |
|--|-------------|-------------|
| VISUAL INDICATOR LAMINATE                  |             |             |
| Visual Indicator Laminate (for Thumb-Turn) | 86329       | 21.00       |

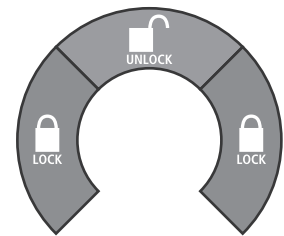



## J Series Semi-Trailer Kingpin Locks

### How To Order

| 2J                 | 7   | L   | 1  | -  |   |
|--------------------|---|---|--|--|---|
| Series             | Core Housing                              | Latch Type  | Head Type                                    | Armored Front                                | Options                                   |
| 2J – Standard body | 7 – 7-pin housing; accepts all BEST cores | L - Latch (Spring Return)<br>D - Deadlocking Bolt | 1 - Single Head Unit<br>2 - Double Head Unit | 1 - Armored Front<br>"- " - No Armored Front | TA* - Extended face without armored front |

| FUNCTION DESCRIPTION | FUNCTION CODE | COMPLETE WITH COMBINATED CORE |           |          | LESS CORE |
|----------------------|---------------|-------------------------------|-----------|----------|-----------|
|                      |               | PATENTED*                     | PREMIUM** | STANDARD |           |
| Single latch         | L1            | 857.00                        | 857.00    | 845.00   | 775.00    |
| Double latch         | L2            | 1259.00                       | 1259.00   | 1235.00  | 1095.00   |
| Single deadbolt      | D1            | 827.00                        | 827.00    | 815.00   | 745.00    |
| Double deadbolt      | D2            | 1217.00                       | 1217.00   | 1193.00  | 1053.00   |

\*If TA option is not included, only CORMAX M Series patented keying system can be used and pricing shown applies. If TA option is included, BEST Preferred keying system can be used and \$20.00 must be added to pricing shown. \*\*Applicable only if TA option is included.

| PART DESCRIPTION       | CATALOG NUMBER | PRICE  |
|------------------------|----------------|--------|
| <b>Accessories:</b>    |                |        |
| Warning flag assembly  | 2JOF1          | 80.00  |
| <b>Storage Racks:</b>  |                |        |
| Three post mount       | 2JOR3          | 509.00 |
| Three post—cad. plated | 2JOR3C         | 637.00 |
| Five post mount        | 2JOR5          | 853.00 |
| Five post—cad. plated  | 2JOR5C         | 951.00 |

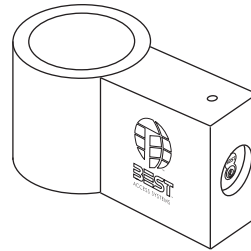

2J7L1

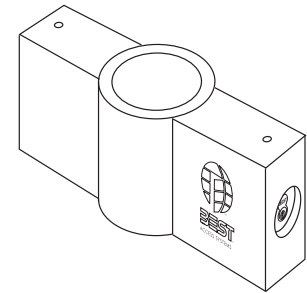

2J7L2

NOTE: Patented or Premium core is available in J Series with the TA option only.



## 6K Series Grade 2 Cylindrical Locks - Knobs

Federal Spec. 160

ANSI Series 4000

### How To Order

| 6K     | 3  | 7  | AB            | 4                      | C                                  | STK   | 626  |   |
|--------|--|--|---------------|------------------------|------------------------------------|---|--|---|
| Series | Backset  | Core Housing   | Function Code | Knob Style             | Trim Style                         | Strike Package                                  | Finish   | Options   |
| 6K     | 2 – 2-3/8"<br>3 – 2-3/4"<br>4* – 3-3/4"<br>5* – 5" | 0 – Keyless<br>7 – 7-pin housing; accepts all BEST cores | See below     | 4 – Round<br>6 – Tulip | C – 2-9/16"<br>D* – 3-3/8"<br>Rose | STK – Standard<br>S3 – ANSI<br>LS – Less strike | 626<br><br>Satin*<br>606<br>612<br>613<br><br>Bright*<br>605<br>611<br>625 | KNL* – Knurled knobs (keyed knob only)<br>L8 – Drive-in latch<br>NF – Narrow face latch (std with 62K)<br>WF – Wide face latch (std with 63K) |

| FUNCTION DESCRIPTION | FUNCTION CODE | COMPLETE WITH COMBINATED CORE |         |          | LESS CORE |
|----------------------|---------------|-------------------------------|---------|----------|-----------|
|                      |               | PATENTED*                     | PREMIUM | STANDARD |           |
| <b>Single Keyed:</b> |               |                               |         |          |           |
| Office               | AB            | 325.00                        | 325.00  | 313.00   | 243.00    |
| Storeroom            | D             | 325.00                        | 325.00  | 313.00   | 243.00    |
| Service station      | E             | 325.00                        | 325.00  | 313.00   | 243.00    |
| Classroom            | R             | 325.00                        | 325.00  | 313.00   | 243.00    |
| <b>Keyless:</b>      |               |                               |         |          |           |
| Passage              | N             | N/A                           | N/A     | N/A      | 147.00    |
| Exit                 | Y             | N/A                           | N/A     | N/A      | 147.00    |
| Privacy              | L             | N/A                           | N/A     | N/A      | 196.00    |
| Hospital privacy     | LL            | N/A                           | N/A     | N/A      | 196.00    |
| Patio                | P             | N/A                           | N/A     | N/A      | 196.00    |
| Single dummy trim    | 1DT           | N/A                           | N/A     | N/A      | 80.00     |
| Double dummy trim    | 2DT           | N/A                           | N/A     | N/A      | 156.00    |

\*Patented pricing shown is for CORMAX patented keying system. Add \$20.00 for BEST Preferred patented keying.

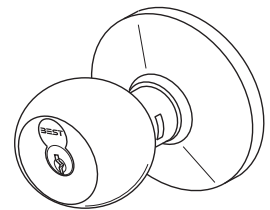

4D\*

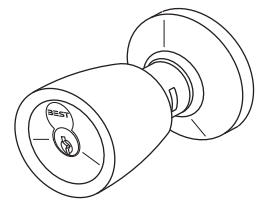

6C

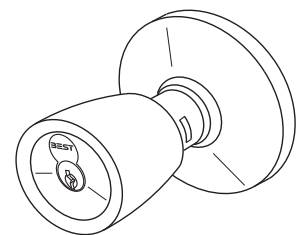

6D\*

| EXTRA COST OPTIONS*        | OPTION CODE         | ADD-ON |
|----------------------------|---------------------|--------|
| Satin finishes (per lock)  | 606, 612, 613, etc. | 19.00  |
| Bright finishes (per lock) | 605, 611, 625, etc. | 43.00  |
| Special backset            | 64K / 65K           | 10.00  |
| Knurled keyed knob         | KNL                 | 24.00  |
| 3-3/8" Rose                | D                   | 19.00  |

| PART DESCRIPTION         | PART NUMBER | PART PRICE |
|--------------------------|-------------|------------|
| 2-3/8" deadlocking latch | 6KL2        | 44.00      |
| 2-3/4" deadlocking latch | 6KL3        | 44.00      |
| 3-3/4" deadlocking latch | 6KL4        | 52.00      |
| 5" deadlocking latch     | 6KL5        | 52.00      |
| 2-3/8" drive-in latch    | 6KL2-8      | 44.00      |
| 2-3/4" drive-in latch    | 6KL3-8      | 44.00      |
| Standard strike package  | 7KCS2       | 7.90       |
| ANSI strike package      | 7KCS3       | 24.00      |
| Standard throw member    | 3125559     | 16.00      |
| Standard strike box      | B25640      | 4.80       |



## 7KC Series Grade 2 Cylindrical Locks - Levers

Federal Spec. 160

ANSI Series 4000

### How To Order

| 7KC    | 3  | 7   | AB            | 15   | D          | STK                         | 626  |   |
|--------|--|---|---------------|--|------------|-----------------------------|--|---|
| Series | Backset  | Core Housing  | Function Code | Lever Style  | Trim Style | Strike Package              | Finish   | Options   |
| 7KC    | 2 – 2-3/8"<br>3 – 2-3/4"<br>4* – 3-3/4"<br>5* – 5" | 0 – Keyless<br>6 – 6-pin non-IC cylinder<br>7 – 7-pin housing; accepts all BEST cores | See below     | 14 – Curved return<br>15 – Contour angle return<br>16 – Curved no return | D – 3-1/2" | STK – Standard<br>S3 – ANSI | 626<br><br>Satin*<br>606<br>612<br>613<br><br>Bright*<br>605 625 | L8 – Drive-in latch (only available on 2-3/8" and 2-3/4" backset).<br>0B** – Zero bitted<br>KA** – Keyed alike<br>KD** – Keyed different<br>OEM*** – Orig equipment mfg<br>ATB – Alternate through-bolt<br>NF – Narrow face latch |

\*Indicates extra cost option

\*\*Six-pin cylinder in Schlage "C" keyway included with 0B, KA, & KD options. Must specify 6 for core housing.

\*\*\*Cylinders not included with OEM option. Must specify "0" for core housing.

| FUNCTION DESCRIPTION | FUNCTION CODE | COMPLETE WITH COMBINATED CORE |         |          | LESS CORE | NON-IC CYLINDER<br>0B, KA, KD |
|----------------------|---------------|-------------------------------|---------|----------|-----------|-------------------------------|
|                      |               | PATENTED*                     | PREMIUM | STANDARD |           |                               |
| <b>Single Keyed:</b> |               |                               |         |          |           |                               |
| Entrance             | AB            | 386.00                        | 386.00  | 374.00   | 304.00    | 355.00                        |
| Storeroom            | D             | 386.00                        | 386.00  | 374.00   | 304.00    | 355.00                        |
| Classroom            | R             | 386.00                        | 386.00  | 374.00   | 304.00    | 355.00                        |
| <b>Keyless:</b>      |               |                               |         |          |           |                               |
| Passage              | N             | N/A                           | N/A     | N/A      | 223.00    | N/A                           |
| Exit                 | Y             | N/A                           | N/A     | N/A      | 216.00    | N/A                           |
| Privacy              | L             | N/A                           | N/A     | N/A      | 245.00    | N/A                           |
| Single dummy trim    | 1DT           | N/A                           | N/A     | N/A      | 100.00    | N/A                           |

\*Patented pricing shown is for CORMAX patented keying system. Add \$20.00 for BEST Preferred patented keying.

| EXTRA COST OPTIONS*        | OPTION CODE    | ADD-ON |
|----------------------------|----------------|--------|
| Satin finishes (per lock)  | 612, 613, etc. | 19.00  |
| Bright finishes (per lock) | 605, 625, etc. | 43.00  |
| Special backset            | 74KC / 75KC    | 10.00  |

| PART DESCRIPTION         | PART NUMBER | PART PRICE |
|--------------------------|-------------|------------|
| 2-3/8" deadlocking latch | 7KCL2       | 44.00      |
| 2-3/4" deadlocking latch | 7KCL3       | 44.00      |
| 3-3/4" deadlocking latch | 6KL4        | 52.00      |
| 5" deadlocking latch     | 6KL5        | 52.00      |
| Standard strike package  | 7KCS2       | 7.90       |
| ANSI strike package      | 7KCS3       | 24.00      |
| Standard strike box      | B25640      | 4.80       |



## 8K Series Grade 1 Cylindrical Locks - Knobs

Federal Spec. 160

ANSI Series 4000

### How To Order

| 8K     | 3                                    | 7   | AB            | 4                      | D  | STK  | 626  |   |
|--------|--------------------------------------|---|---------------|------------------------|--|--|--|---|
| Series | Backset                              | Core Housing  | Function Code | Knob Style             | Rose Style   | Strike Package   | Finish   | Options   |
| 8K     | 3 – 2-3/4"<br>4* – 3-3/4"<br>5* – 5" | 0 – Keyless<br>7 – 7-pin housing; accepts<br>all BEST cores | See below     | 4 – Round<br>6 – Tulip | A – 3-3/8" concave<br>C – 2-9/16" concave<br>D – 3-3/8" convex<br>E – 3-3/8" concave -<br>thick door | STK – Standard<br>S3 – ANSI<br>S3 7/8* – 7/8"<br>lip-to-center<br>strike<br>LS – Less strike<br>S5<br>S6 | 626 690<br>626AM*<br><br>Satin*<br>606 612<br>613 619<br><br>Bright*<br>605 611<br>625 | 3/4* – 3/4" throw<br>BRK – Break-away (keyed only)<br>FRL* – Full radius latch<br>LL* – Lead lined (not available in<br>double keyed functions)<br>SH* – Security head screws<br>SPN – Spin free (D & W only)<br>TAC/B* – Tactile both knobs<br>TAC/O* – Tactile outside knob<br>TAC/I* – Tactile inside knob |

\*Indicates extra cost option; see below. Must specify keymark and number of keys.

| FUNCTION DESCRIPTION | FUNCTION CODE | COMPLETE WITH COMBINATED CORE |         |          | LESS CORE |
|----------------------|---------------|-------------------------------|---------|----------|-----------|
|                      |               | PATENTED*                     | PREMIUM | STANDARD |           |
| <b>Single Keyed:</b> |               |                               |         |          |           |
| Entrance             | AB            | 762.00                        | 762.00  | 750.00   | 680.00    |
| Storeroom            | D             | 762.00                        | 762.00  | 750.00   | 680.00    |
| Service station      | E             | 762.00                        | 762.00  | 750.00   | 680.00    |
| Classroom            | R             | 762.00                        | 762.00  | 750.00   | 680.00    |
| Dormitory            | T             | 762.00                        | 762.00  | 750.00   | 680.00    |
| Special              | Note**        | 762.00                        | 762.00  | 750.00   | 680.00    |
| Hotel (SPN-standard) | H, HJ         | 825.00                        | 825.00  | 813.00   | 743.00    |
| <b>Double Keyed:</b> |               |                               |         |          |           |
| Corridor             | C             | 797.00                        | 797.00  | 773.00   | 633.00    |
| Storeroom            | G             | 797.00                        | 797.00  | 773.00   | 633.00    |
| Communicating        | S             | 797.00                        | 797.00  | 773.00   | 633.00    |
| Institutional        | W             | 797.00                        | 797.00  | 773.00   | 633.00    |
| Special              | DR, RD        | 797.00                        | 797.00  | 773.00   | 633.00    |
| <b>Keyless:</b>      |               |                               |         |          |           |
| Passage              | N, NX         | N/A                           | N/A     | N/A      | 513.00    |
| Exit                 | Y             | N/A                           | N/A     | N/A      | 513.00    |
| Privacy              | L             | N/A                           | N/A     | N/A      | 590.00    |
| Patio                | P             | N/A                           | N/A     | N/A      | 590.00    |
| Special              | LL, M, Q, Z   | N/A                           | N/A     | N/A      | 590.00    |
| Single dummy trim    | 1DT           | N/A                           | N/A     | N/A      | 221.00    |
| Double dummy trim    | 2DT           | N/A                           | N/A     | N/A      | 442.00    |

\*Patented pricing shown is for CORMAX patented keying system. Add \$20.00 for BEST Preferred patented keying.

\*\*Single-keyed special functions include: A, B, DZ, EA, RH, RZ, XD, XR, YD, YR, YRH, YRM and YZ

ATTENTION: Locksets that secure both sides of the door (e.g., G, DR, M, RD, S, W, XD, YD & YR functions) are controlled by building codes and the Life Safety Code. Delay in unlocking for rapid emergency exit could be hazardous or even fatal.

## 8K Series Grade 1 Cylindrical Locks (continued)

| EXTRA COST OPTIONS*              | OPTION CODE         | ADD-ON |
|----------------------------------|---------------------|--------|
| Satin finishes (per lock)        | 606, 612, 613, etc. | 19.00  |
| Bright finishes (per lock)       | 605, 611, 625, etc. | 43.00  |
| UltraShield antimicrobial finish | 626AM               | 60.00  |
| 3/4" throw latch                 | 3/4                 | 31.00  |
| Special backsets                 | 84K / 85K           | 21.00  |
| Lead lined                       | LL                  | 228.00 |
| Security head screws             | SH                  | 22.00  |
| Tactile knob both sides          | TAC/B               | 84.00  |
| Tactile knob outside             | TAC/O               | 43.00  |
| Tactile knob inside              | TAC/I               | 43.00  |
| 7/8" Lip-to-center strike        | S3 7/8              | 22.00  |
| Full radius latch                | FRL                 | 21.00  |

| PARTS DESCRIPTION        | PART NUMBER | PART PRICE |
|--------------------------|-------------|------------|
| 2-3/4" deadlocking latch | 8KL3        | 79.00      |
| 3-3/4" deadlocking latch | 8KL4        | 100.00     |
| 5" deadlocking latch     | 8KL5        | 100.00     |
| Standard strike package  | 8KS2        | 7.80       |
| ANSI strike package      | 8KS3        | 24.00      |
| Throw member 7-pin       | B54200      | 1.80       |
| Breakaway knob driver    | B54856      | 8.60       |

NOTE 1: Other special single keyed functions include: A,B, EA, DZ, RZ, XD, XR, YD & YR. ATTENTION: Locksets that secure both sides of the door (e.g. G, DR, M, RD, S, W, XD, YD & YR functions) are controlled by building codes and the Life Safety Code. Delay in unlocking for rapid emergency exit could be hazardous or even fatal.

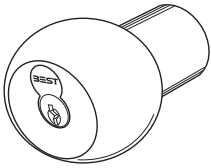

4 – Round

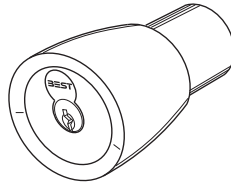

6 – Tulip

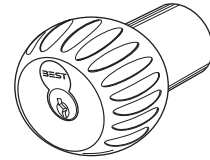

4 – TAC option  
(Blind, safety, & handicapped application)

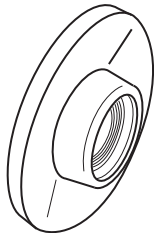

A and C Rose  
(Concave)



D rose  
(Convex)





# 9K Series Grade 1 Cylindrical Locks - Levers

Federal Spec. 160

ANSI Series 4000

## How To Order

| 9K     | 3  | 7  | AB  | 14  | C  | STK   | 626   |   |  |
|--------|--|--|---|---|--|---|---|---|--|
| Series | Backset  | Core Housing   | Function Code   | Lever Style   | Rose Style   | Strike Package  | Finish  | Options   |  |
| 9K     | 3 – 2-3/4"<br>4* – 3-3/4"<br>5* – 5"<br>DT- Dummy Trim | 0 – Keyless functions / or / Non-IC and LFIC competitive cylinder (less core)†<br>6 – 6-pin non-IC cylinder<br>7 – 7-pin housing; accepts all BEST cores | See below (Contact sales support for special functions and pricing.)  | 14 – Curved with return<br>15 – Contour angle with return<br>16 – Curved without return | C – 3" convex<br>D – 3-1/2" convex<br>K – 3" convex no ring<br>L – 3-1/2" convex no ring | STK – Standard<br>S3 – ANSI<br>S3 7/8**<br>STK 7/8***<br>LS – Less strike<br>S3B* - ANSI (Strike w/ Plastic Box)<br>S3B 7/8* - ANSI (Strike w/ Plastic Box) | 626 690<br>622<br>626AM*<br><br>Satin*<br>606 612<br>613 619<br><br>Bright*<br>605 611<br>625 618 | 3/4* – 3/4" throw latch<br>AL/B* – Abrasive lever both sides<br>AL/O* – Abrasive lever outside<br>AL/I* – Abrasive lever inside<br>TL/B* – Tactile lever both sides<br>TL/O* – Tactile lever outside<br>TL/I* – Tactile lever inside<br>ATB - 2-3/4" Through bolt Prep<br>ATB2 - 2-5/8" Through bolt prep<br>FRL* – Full radius latch<br>LL* – Lead lined (N/A for double keyed functions)<br>LM – Lost motion<br>SH* – Security head screws<br>Thin Door* – 1-3/8"<br>OB* – non-IC zero bitted<br>KA* – non-IC keyed alike<br>KD* – non-IC keyed different<br>COR* – non-IC Corbin-Russwin<br>MED* – non-IC Medeco<br>SAR* – non-IC Sargent<br>SCH* – non-IC Schlage<br>YAL* – non-IC Yale<br>SARRC - LFIC Sargent<br>CORRC - LFIC Corbin<br>YALRC - LFIC Yale<br>SCHRC - LFIC Schlage<br>WS – Windstorm Label (NOA Miami-Dade County) |  |
|        |  |  | <p>*Indicates extra cost. Must specify keymark and number of keys.<br/>**S3 7/8 is the ANSI flat lip strike<br/>***STK 7/8 is the standard flat lip strike</p>  |   |  |   |   |   |  |
|        |  |  | <p>COR, MED, SAR, SCH: Chose only one option:<br/>OB, KA, KD; use with core housing option 6<br/>SCHRC, CORRC, SARRC, YALRC: Use with core housing option 0</p> |   |  |   |   |   |  |

| FUNCTION DESCRIPTION | FUNCTION CODE | COMPLETE WITH COMBINATED CORE |         |          | LESS CORE | NON-IC CYLINDER<br>OB, KA, KD |
|----------------------|---------------|-------------------------------|---------|----------|-----------|-------------------------------|
|                      |               | PATENTED*                     | PREMIUM | STANDARD |           |                               |
| <b>Single Keyed:</b> |               |                               |         |          |           |                               |
| Entrance             | AB            | 715.00                        | 715.00  | 703.00   | 633.00    | 684.00                        |
| Storeroom            | D             | 715.00                        | 715.00  | 703.00   | 633.00    | 684.00                        |
| Service station      | E             | 715.00                        | 715.00  | 703.00   | 633.00    | 684.00                        |
| Classroom            | R             | 715.00                        | 715.00  | 703.00   | 633.00    | 684.00                        |
| Dormitory            | T             | 715.00                        | 715.00  | 703.00   | 633.00    | 684.00                        |
| Special**            | Note          | 715.00                        | 715.00  | 703.00   | 633.00    | 684.00                        |
| UA                   | UA            | 715.00                        | 715.00  | 703.00   | 633.00    | 684.00                        |
| Hotel                | H, HJ         | 777.00                        | 777.00  | 765.00   | 695.00    | 746.00                        |
| <b>Double Keyed:</b> |               |                               |         |          |           |                               |
| Corridor             | C             | 857.00                        | 857.00  | 833.00   | 693.00    | 795.00                        |
| Storeroom            | G             | 857.00                        | 857.00  | 833.00   | 693.00    | 795.00                        |
| Intruder***          | IN            | 885.00                        | 885.00  | 861.00   | 721.00    | 823.00                        |
| Communicating        | S             | 885.00                        | 885.00  | 861.00   | 721.00    | 823.00                        |
| Institutional        | W             | 885.00                        | 885.00  | 861.00   | 721.00    | 823.00                        |
| Special              | DR, RD        | 885.00                        | 885.00  | 861.00   | 721.00    | 823.00                        |
| <b>Keyless:</b>      |               |                               |         |          |           |                               |
| Passage              | N, NX         | N/A                           | N/A     | N/A      | 441.00    | N/A                           |
| Exit                 | Y             | N/A                           | N/A     | N/A      | 441.00    | N/A                           |
| Privacy              | L             | N/A                           | N/A     | N/A      | 509.00    | N/A                           |
| Patio                | P             | N/A                           | N/A     | N/A      | 509.00    | N/A                           |
| Special              | LL, M, Q, Z   | N/A                           | N/A     | N/A      | 509.00    | N/A                           |
| Single dummy trim    | 1DT           | N/A                           | N/A     | N/A      | 187.00    | N/A                           |
| Double dummy trim    | 2DT           | N/A                           | N/A     | N/A      | 367.00    | N/A                           |

\*Patented pricing shown is for CORMAX patented keying system.  
Add \$20.00 for BEST Preferred patented keying.

\*\*Single-keyed special functions include: A, B, DZ, EA, RH, RZ, XD, XR, YD, YR, YRH, YRM and YZ  
\*\*\* IN Function includes interior indicator rose standard

## 9K Series Grade 1 Cylindrical Locks (continued)

| EXTRA COST OPTIONS*              | OPTION CODE         | ADD-ON |
|----------------------------------|---------------------|--------|
| Satin finishes (per lock)        | 606, 612, 613, etc. | 19.00  |
| Bright finishes (per lock)       | 605, 625, 629, etc. | 43.00  |
| UltraShield antimicrobial finish | 626AM               | 60.00  |
| Thin door 1-3/8"                 | 1-3/8"              | 80.00  |
| 3/4" throw latch                 | 3/4                 | 31.00  |
| Special backsets                 | 94K / 95K           | 21.00  |
| Lead lined                       | LL                  | 228.00 |
| Security head screws             | SH                  | 22.00  |
| Abrasive lever both sides        | AL/B                | 43.00  |
| Abrasive lever outside           | AL/O                | 22.00  |
| Abrasive lever inside            | AL/I                | 22.00  |
| Tactile lever both sides         | TL/B                | 84.00  |
| Tactile lever outside            | TL/O                | 43.00  |
| Tactile lever inside             | TL/I                | 43.00  |
| 7/8" Lip-to-center strike        | S3 7/8 or STK 7/8   | 22.00  |
| Strike with plastic box          | S3B or S3B 7/8      | 2.20   |
| Full radius latch                | FRL                 | 21.00  |

\*Choose only one option: OB, KA, KD-use with core housing option 6. COR, MED, SAR, SCH, YAL, SCHRC-use with core housing option 0

| *EXTRA COST OPTIONS                  | OPTION CODE | ADD-ON PRICE |
|--------------------------------------|-------------|--------------|
| Non-IC Corbin-Russwin (single keyed) | COR         | 6.60         |
| Non-IC Corbin-Russwin (double keyed) | COR         | 15.00        |
| Non-IC Medeco (single keyed)         | MED         | 6.60         |
| Non-IC Medeco (double keyed)         | MED         | 15.00        |
| Non-IC Sargent (single keyed)        | SAR         | 6.60         |
| Non-IC Sargent (double keyed)        | SAR         | 15.00        |
| Non-IC Schlage (single keyed)        | SCH         | 6.60         |
| Non-IC Schlage (double keyed)        | SCH         | 15.00        |
| Non-IC Yale (single keyed)           | YAL         | 6.60         |
| Non-IC Yale (double keyed)           | YAL         | 15.00        |

NOTE: These options do not come with a cylinder. The lock is just prepped for cylinders of these other manufacturers and comes with a throw member for that manufacturer's cylinder.

| PART DESCRIPTION         | PART NUMBER | PART PRICE |
|--------------------------|-------------|------------|
| 2-3/4" deadlocking latch | 8KL3        | 79.00      |
| 3-3/4" deadlocking latch | 8KL4        | 100.00     |
| 5" deadlocking latch     | 8KL5        | 100.00     |
| Standard strike package  | 8KS2        | 7.80       |
| ANSI strike package      | 8KS3        | 24.00      |
| Throw member 7-pin       | B54200      | 1.80       |

NOTE 1: Other special single keyed functions include: A, B, EA, DZ, RZ, XD, XR, YD & YR. ATTENTION: Locksets that secure both sides of the door (e.g. G, DR, M, RD, S, W, XD, YD & YR 'functions) are controlled by building codes and the Life Safety Code. Delay in unlocking for rapid emergency exit could be hazardous or even fatal.

## Adaptation Kit

| 9KA                  | SCHRCKT                             | 14   | 626                | Price |
|----------------------|-------------------------------------|--|--------------------|-------|
| Family               | Kit Type                            | Lever Style  | Finish             |       |
| 9KA - Adaptation Kit | SCHRCKT - Schlage RC Adaptation Kit | 14 - Curved return<br>15 - Contour angle return<br>16 - Curved no return | 606, 626, 612, 613 | 91.00 |

NOTE: Lever Style 16 is considered a special order item and may have extended lead times. Consult factory for lead times.

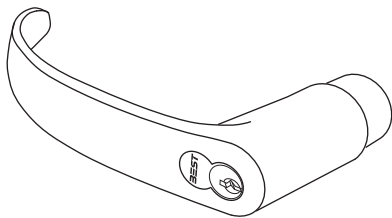

14 - Curved return

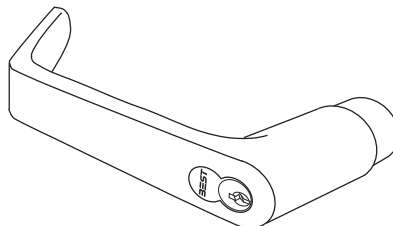

15 - Contour angle return

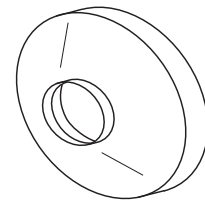

C and D Roses

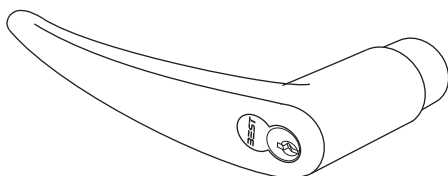

16 - Curved no return

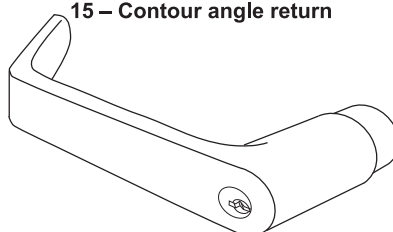

15 - Non IC contour angle return

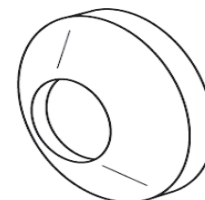

K and L roses



# AK Series Knob Adaptations (formerly KA series)

## How To Order

| Series | Adaptation Kit Number   | Finish |
|--------|---|--------|
| AK     | Please contact BEST for the specific kit number to convert your heavy duty lockset. The name of the manufacturer and model number are required. | 626    |

Must specify keymark and number of keys.

| MANUFACTURER'S NAME | COMPLETE WITH COMBINATED CORE |           |         | LESS CORE PRICE |
|---------------------|-------------------------------|-----------|---------|-----------------|
|                     | PATENTED*                     | PATENTED* | PREMIUM |                 |
| Corbin              | 245.00                        | 245.00    | 233.00  | 163.00          |
| Sargent             | 269.00                        | 269.00    | 257.00  | 187.00          |
| Schlage             | 222.00                        | 222.00    | 210.00  | 140.00          |
| Russwin             | 245.00                        | 245.00    | 233.00  | 163.00          |
| Yale                | 269.00                        | 269.00    | 257.00  | 187.00          |

|                                     |       |
|-------------------------------------|-------|
| <b>INSTALLATION AT BEST FACTORY</b> | 69.00 |
|-------------------------------------|-------|

| KIT COMPONENTS | KNOB ONLY LESS CORE | THROW MEMBER |
|----------------|---------------------|--------------|
| Corbin         | 140.00              | 35.00        |
| Sargent        | 159.00              | 25.00        |
| Schlage        | 117.00              | 22.00        |
| Russwin        | 136.00              | 35.00        |
| Yale           | 159.00              | 29.00        |

\*Patented pricing shown is for CORMAX patented keying system. Add \$20.00 for BEST Preferred patented keying.

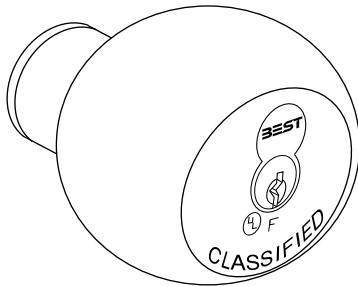

Schlage round

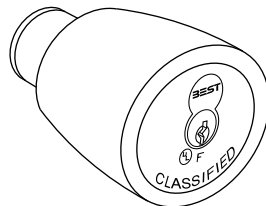

Schlage tulip

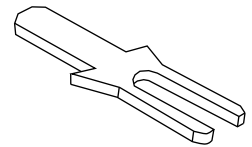

Schlage throw member



## L Series Cabinet Locks

### How To Order

| 5L            | 7   | R                      | D                                 | 2                            | 606   |  |
|---------------|---|------------------------|-----------------------------------|------------------------------|---|--|
| Series        | Core Housing  | Mounting Type          | Latch Type                        | Hand                         | Finish  | Options  |
| 3L – Coin box | 5 – 5-pin housing<br>6 – 6-pin housing<br>7 – 7-pin housing; accepts all BEST cores | R – Rim                | D – Dead-locking                  | 2 – Vertical                 | 626 690<br>Satin*                               | 1-1/8" to 2" – Special cylinder (specify length) |
| 5L – Standard |   | M – Mortise<br>R – Rim | D – Dead-locking<br>L – Latchbolt | 2 – Vertical<br>5 – Inverted | 606 612<br>613 619<br>Bright*<br>605 611<br>625 |  |

\*Indicates extra cost option; see below. Must specify keymark and number of keys.

| DESCRIPTION           | SERIES | COMPLETE WITH COMBINED CORE |         |          | LESS CORE |
|-----------------------|--------|-----------------------------|---------|----------|-----------|
|                       |        | PATENTED*                   | PREMIUM | STANDARD |           |
| <b>CABINET LOCKS</b>  |        |                             |         |          |           |
| Cabinet—mortise & rim | 3L     | 185.00                      | 185.00  | 173.00   | 103.00    |
| Cabinet—mortise & rim | 5L     | 157.00                      | 157.00  | 145.00   | 75.00     |

| EXTRA COST OPTIONS*        | OPTION CODE  | ADD-ON |
|----------------------------|--------------|--------|
| Square latch spl. cylinder | SL           | 20.00  |
| Special cylinders-3L       | 1-1/2" to 2" | 22.00  |
| Special cylinders-5L       | 1-1/8" to 2" | 22.00  |
| Special finishes           | See above    | 5.60   |

| DESCRIPTION                    | CATALOG NO. | COMPLETE WITH COMBINED CORE |         |          | LESS CORE |
|--------------------------------|-------------|-----------------------------|---------|----------|-----------|
|                                |             | PATENTED*                   | PREMIUM | STANDARD |           |
| <b>8L SERIES MAIL BOX LOCK</b> |             |                             |         |          |           |
| Standard mail box lock         | 8L7SPR-627  | 210.00                      | 210.00  | 198.00   | 128.00    |

\*Patented pricing shown is for CORMAX patented keying system. Add \$20.00 for BEST Preferred patented keying.

NOTE: You must specify the name of the manufacturer and the model number.

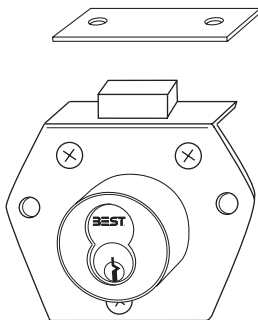

5L7RD2

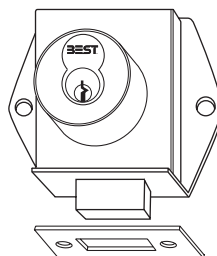

5L7MD

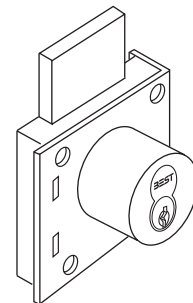

3L7RD2 - Vertical Only



# P Series Push Locks

## How To Order

| 2P                | 7                                 | 3                              | 626        |
|-------------------|-----------------------------------|--------------------------------|------------|
| Series            | Lock Body                         | Mounting slot                  | Finish     |
| 2P – File cabinet | 7 – 7-pin body may be keyed 6-pin | 3 – Vertical<br>4 – Horizontal | 606<br>626 |

| DESCRIPTION              | CATALOG NO. | COMPLETE WITH COMBINATED CORE |         |          | LESS CORE |
|--------------------------|-------------|-------------------------------|---------|----------|-----------|
|                          |             | PATENTED*                     | PREMIUM | STANDARD |           |
| <b>2P SERIES</b>         |             |                               |         |          |           |
| Vertical mounting slot   | 2P73        | 208.00                        | 208.00  | 196.00   | 126.00    |
| Horizontal mounting slot | 2P74        | 208.00                        | 208.00  | 196.00   | 126.00    |

\*Patented pricing shown is for CORMAX patented keying system.  
Add \$20.00 for BEST Preferred patented keying.

NOTE: You must specify the make, model and year of the filing cabinet for the 2P Series.

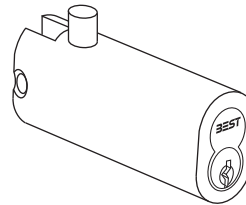

2P73

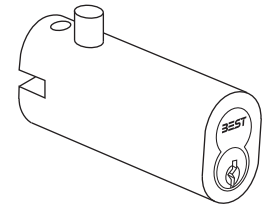

2P74



## S Series Sliding Door Locks

### How To Order

| 3S   | 7  | 5             | 627   |  |
|--|--|---------------|---|--|
| Series   | Core housing   | Function code | Finish  | Options  |
| 2S – Sliding door push<br>3S – Sliding panel<br>4S – Sliding door cyl. | 7 – 7-pin housing; accepts all BEST cores<br>(4S requires 6C core) | See below     | 2S – 626, 605, 606, 622, 625<br>4S – 625, 605, 606, 626<br>3S – 627 | 3S – Strike straps:<br>S1* – 1/4" thick<br>S2* – Standard 1/4"<br>S3 – 5/16" to 1/2"<br>S4 – 1/2" to 11/16"<br>S5 – 3/4" & thicker |

\*Included in the price of the housing.

| FUNCTION DESCRIPTION        | CATALOG NUMBER | COMPLETE WITH COMBINATED CORE |         |          | LESS CORE |
|-----------------------------|----------------|-------------------------------|---------|----------|-----------|
|                             |                | PATENTED*                     | PREMIUM | STANDARD |           |
| <b>2S SERIES</b>            |                |                               |         |          |           |
| Surface mount—1/2" bolt     | 3              | 274.00                        | 274.00  | 262.00   | 192.00    |
| Through bolt—1/2" bolt      | 3TBM           | 331.00                        | 331.00  | 319.00   | 249.00    |
| Through bolt—3/4" bolt      | 4TBM           | 331.00                        | 331.00  | 319.00   | 249.00    |
| Surface mount—bolt pin      | 5              | 331.00                        | 331.00  | 319.00   | 249.00    |
| <b>3 S SERIES</b>           |                |                               |         |          |           |
| Straight housing            | 5              | 232.00                        | 232.00  | 220.00   | 150.00    |
| Captured panel housing      | 7              | 232.00                        | 232.00  | 220.00   | 150.00    |
| Housing with 1" extension   | 8              | 304.00                        | 304.00  | 292.00   | 222.00    |
| <b>4 S SERIES</b>           |                |                               |         |          |           |
| Sliding glass door cylinder | 3              | 162.00                        | 162.00  | 150.00   | 80.00     |
| Sliding wood door cylinder  | 4              | 177.00                        | 177.00  | 165.00   | 95.00     |

\* Patented pricing shown is for CORMAX patented keying system. Add\$20.00 for BEST Preferred patented keying.

\*\* Lock requires 6C core (not available with Peaks or Preferred keying).

| FUNCTION DESCRIPTION            | PAR NUMBER | SEPARATE | WITH LOCK ADD-ON |
|---------------------------------|------------|----------|------------------|
| <b>3S STRIKE STRAPS</b>         |            |          |                  |
| 4-1/4" long for 1/4" panel      | 3SS1       | 25.00    | N/A              |
| 6-1/4" long for 1/4" panel      | 3SS2       | 30.00    | N/A              |
| <b>STANDARD</b>                 |            |          |                  |
| 6-1/4" long for 5/16" to 1/2"   | 3SS3       | 43.00    | 17.00            |
| 6-1/4" long for 1/2" to 11/16"  | 3SS4       | 52.00    | 26.00            |
| 6-1/4" long for 3/4" or thicker | 3SS5       | 39.00    | 7.10             |



## SPSL – Secure Patient Safety Lever

### How To Order - Mortise Safety Levers

| SPSL                               | ML           | R   | 16F   | 630                       | RH                          |                        |
|------------------------------------|--------------|---|---|---------------------------|-----------------------------|------------------------|
| Series                             | Chassis      | Function  | Lever   | Finish                    | Hand                        |                        |
| SPSL – Secure Patient Safety Lever | ML – Mortise | A – Office privacy<br>D – Storeroom<br>IND – Intruder deadbolt<br>IND2 – Intruder storeroom dblt<br>INL – Intruder latch<br>LT – Bathroom privacy<br>LTF – Bedroom privacy (Anti-Lockout)<br>R – Classroom<br>RF – Bedroom privacy<br>T – Dormitory deadbolt<br>W1 – Asylum lever/lever<br>W2 – Asylum double cyl lever/lever | W3 – Asylum deadbolt lever/lever<br>W4 – Asylum deadbolt double cyl lever/lever<br>W10 – Asylum lever/blank<br>W20 – Asylum double cyl lever/blank<br>W30 – Asylum deadbolt lever/blank<br>W40 – Asylum deadbolt double cyl lever/blank | 16F – Anti-ligature lever | 630 – Satin stainless steel | RH<br>LH<br>RHR<br>LHR |

| PRODUCT DESCRIPTION                    | FUNCTION CODE | PRICE*   |
|--|---------------|----------|
| <b>Mortise Safety Lever</b>            |               |          |
| Office privacy                         | A             | 1,718.00 |
| Storeroom                              | D             | 1,583.00 |
| Intruder deadbolt                      | IND           | 1,583.00 |
| Intruder storeroom deadbolt            | IND2          | 1,583.00 |
| Intruder latch                         | INL           | 1,583.00 |
| Bathroom privacy                       | LT            | 1,718.00 |
| Passage                                | ON            | 1,449.00 |
| Bedroom privacy (RF)                   | RF            | 1,718.00 |
| Bedroom privacy Anti-Lockout (LTF)     | LTF           | 1,718.00 |
| Classroom                              | R             | 1,583.00 |
| Dormitory deadbolt                     | T             | 1,583.00 |
| Asylum lever/lever                     | W1            | 1,583.00 |
| Asylum double cyl lever/lever          | W2            | 1,583.00 |
| Asylum deadbolt lever/lever            | W3            | 1,583.00 |
| Asylum deadbolt double cyl lever/lever | W4            | 1,583.00 |
| Asylum lever/blank                     | W10           | 1,583.00 |
| Asylum double cyl lever/blank          | W20           | 1,583.00 |
| Asylum deadbolt lever/blank            | W30           | 1,583.00 |
| Asylum deadbolt double cyl lever/blank | W40           | 1,583.00 |

### How To Order - Cylindrical Safety Levers

| SPSL                               | CL  | ON   | 16F                       | 630                         | RH                     |
|------------------------------------|---|--|---------------------------|-----------------------------|------------------------|
| Series                             | Chassis   | Function   | Lever                     | Finish                      | Hand                   |
| SPSL – Secure Patient Safety Lever | CL – Cylindrical 2 3/4" backset<br>CL5 – Cylindrical 5" backset | ON – Cylindrical passage<br>ONX – Cylindrical passage blank interior | 16F – Anti-ligature lever | 630 – Satin stainless steel | RH<br>LH<br>RHR<br>LHR |

| PRODUCT DESCRIPTION             | FUNCTION CODE | PRICE    |
|---------------------------------|---------------|----------|
| <b>Cylindrical Safety Lever</b> |               |          |
| Passage                         | ON            | 1,259.00 |
| Passage blank interior          | ONX           | 1,259.00 |
| <b>Dummy Trim</b>               |               |          |
| Dummy Trim                      | DT            | 701.00   |

\*Standard offering is less cylinder and less core.

NOTE: Security head screws come standard with SPSL series.



## SPSL – Secure Patient Safety Lever (continued)

| PART DESCRIPTION   | KIT NUMBER  | LIST PRICE |
|--|-------------|------------|
| Cylindrical Security head screw kit                        | SPSL-SH C1  | 19.00      |
| Mortise Security head screw kit                            | SPSL-SH M1  | 19.00      |
| Security head driver kit                                   | SPSL-SH D1  | 19.00      |
| Turnpiece Disable kit for Female Privacy Locks             | SPSL-TD     | 119.00     |
| Cylinder Protector for IC core cylind. SPSL (incl. 2 keys) | SPSL-CP-IC  | 832.00     |
| Cylinder Protector for non-IC cylind. SPSL (incl. 2 keys)  | SPSL-CP-NIC | 832.00     |
| Extra magnetic key for SPSL-CP                             | SPSL-CP-K   | 33.00      |

### How To Order - Electrified Mortise Safety Levers

| SP                        | SE                       |                                     | ML                                  |             | R  | N   | L   | 630  | RH                               |                        |
|---------------------------|--------------------------|-------------------------------------|-------------------------------------|-------------|--|---|---|--|----------------------------------|------------------------|
| Series                    | Electric Release Trim(s) |                                     |                                     | Chassis     | Interior Trim Blank  | Function Group  |   |  | Finish                           | Hand                   |
|                           | Designation              | Exterior                            | Interior                            |             |  | RQE   | DPS   | LPS  |                                  |                        |
| SP- Secure Patient Safety | SE                       | Electric Release Trim (Fail Secure) | Mechanical                          | ML- Mortise | 'leave empty' - if interior trim required (standard) X** - No trim on the interior, just a blank plate (SPSE or SPSF only) | R* - Request to Exit<br>N- Place-holder if RQE not selected | D* - Door Position<br>N- Place-holder if DPS not selected | L* - Latch Position<br>N- Place-holder if LPS not selected | 630- Satin<br>Stainless<br>Steel | RH<br>LH<br>RHR<br>LHR |
|                           | SF                       | Electric Release Trim (Fail Safe)   | Mechanical                          |             |  |   |   |  |                                  |                        |
|                           | S3                       | Electric Release Trim (Fail Secure) | Electric Release Trim (Fail Secure) |             |  |   |   |  |                                  |                        |
|                           | S4                       | Electric Release Trim (Fail Safe)   | Electric Release Trim (Fail Safe)   |             |  |   |   |  |                                  |                        |

\*Indicates extra cost option.

\*\*Option only available for SPSE and SPSF trims. Security hardware comes standard.

| FUNCTION DESCRIPTION                                | FUNCTION CODE | PRICE*   |
|---|---------------|----------|
| SPSE - Exterior Release Trim (Fail Secure)          | NNN†          | 2,497.00 |
| SPSF - Exterior Release Trim (Fail Safe)            | NNN†          | 2,608.00 |
| SPS3 - Exterior/Interior Release Trim (Fail Secure) | NNN†          | 2,560.00 |
| SPS4 - Exterior/Interior Release Trim (Fail Safe)   | NNN†          | 2,608.00 |

| EXTRA COST OPTIONS* | OPTION CODE | ADD-ON |
|---------------------|-------------|--------|
| Function Code (RQE) | R           | 54.00  |
| Function Code (DPS) | D           | 80.00  |
| Function Code (LPS) | L           | 54.00  |

†Indicates extra cost options for RQE, DPS or LPS functions.

\*Standard offering is less cylinder and less core.





**SSRL – Secure Seclusion Room/Time Out Room Locks**

| <b>PRODUCT DESCRIPTION</b>  | <b>PRODUCT NUMBER</b> | <b>PRICE</b> |
|---|-----------------------|--------------|
| 3-Point constant supervision  | SSRLS-3               | 2,014.00     |
| 3-Point unsupervised  | SSRLU-3               | 2,152.00     |
| Alum. angled strike kit for 3 point outswing doors                        | SSRL-SK3              | 501.00       |
| Single point constant supervision   | SSRLS-1               | 1,189.00     |
| Single point constant supervision, includes strike kit for outswing doors | SSRLS-1-SK1           | 1,241.00     |
| Single point unsupervised   | SSRLU-1               | 1,326.00     |
| Single point unsupervised, includes strike kit for outswing doors         | SSRLU-1-SK1           | 1,379.00     |
| Strike kit for single point outswing doors                                | SSRL-SK1              | 54.00        |
| 3-Point constant supervision w/ digital counter                           | SSRLS-3-C             | 2,208.00     |
| 3-Point unsupervised w/ digital counter                                   | SSRLU-3-C             | 2,345.00     |



## SEDA – Secure Emergency Door Alarm

| PRODUCT DESCRIPTION   | PRODUCT NUMBER      | PRICE    |
|---|---------------------|----------|
| Sensor – 36" to 42" wide door                                       | SEDA-DSA-P1         | 881.00   |
| Sensor – 42" to 48" wide door                                       | SEDA-DSA-P2         | 949.00   |
| 12 Door controller/power supply                                     | SEDA-CPS-1A52-12    | 2,740.00 |
| 24 Door controller/power supply                                     | SEDA-CPS-1A52-24    | 4,814.00 |
| 36 Door controller/power supply                                     | SEDA-CPS-1A52-36    | 6,886.00 |
| 48 Door controller/power supply                                     | SEDA-CPS-1A52-48    | 9,654.00 |
| Second console output   | SEDA-CPS-MOD-CONS-2 | 319.00   |
| 12 Door LED console   | SEDA-DCRS-12        | 1,744.00 |
| 24 Door LED console   | SEDA-DCRS-24        | 2,905.00 |
| 36 Door LED console   | SEDA-DCRS-36        | 4,067.00 |
| 48 Door LED console   | SEDA-DCRS-48        | 7,454.00 |
| 12 Door LED Wall Console  | SEDA-WCRS-12        | 2,489.00 |
| 24 Door LED Wall Console  | SEDA-WCRS-24        | 3,817.00 |
| 36 Door LED Wall Console  | SEDA-WCRS-36        | 5,343.00 |
| Wall mounted keyswitch  | SEDA-KS101          | 319.00   |
| Strobe light ceiling mount  | SEDA-SL1            | 151.00   |
| Strobe light ceiling mount w/ steel mounting plate                  | SEDA-SL2            | 185.00   |
| Full surface angled alum. hinge modified for new or existing hinges | SEDA-ECHF5-MH-AL-4  | 1,032.00 |
| Splice box for room w/ multiple doors                               | SEDA-SPLB-1         | 185.00   |



# T Series Tubular Deadbolts

Federal Spec. 180, 181

**NOTE: 8T=ANSI/BHMA Grade 1 • 7T=ANSI/BHMA Grade 2**

## How To Order

| 8T/7T  | 3          | 7   | K             | STK  | 606    |   |
|--------|------------|---|---------------|--|--------|---|
| Series | Backset    | Core Housing                              | Function Code | Strike   | Finish | Options   |
| 8T     | 2 – 2-3/8" | 7 – 7-pin housing; accepts all BEST cores | See below     | STK – Std deadbolt<br>S1 – ANSI deadbolt<br>S4 – Lip deadbolt<br>S5* – High security deadbolt (only available in 630 finish) | 626    | CS* – Concealed screws<br>D5 – Drive-in bolt (8T only)<br>LL* – Lead lined (8T only)<br>NF – Narrow face 1" on 8T3 (std. on 8T2)<br>WF – Wide face 1-1/8" on 8T2 (std. on 8T3)<br>SH* – Security head screws (8T only)<br>Thick Door* – specify thickness (8T only)<br>Thin Door* – specify thickness (8T only) |
| 7T     | 3 – 2-3/4" |   |               |  | 690    |   |
|        |            | 626AM*                                    |               |  |        |   |
|        |            | Satin*                                    |               |  |        |   |
|        |            | 606 612 613                               |               |  |        |   |
|        |            | 619                                       |               |  |        |   |
|        |            | Bright*                                   |               |  |        |   |
|        |            | 605 611 625 (8T only)                     |               |  |        |   |
|        |            | 7T  |               |  |        |   |
|        |            | 626 612                                   |               |  |        |   |

\*Indicates extra cost option; see below.

| DESCRIPTION              | FUNCTION CODE | COMPLETE WITH COMBINATED CORE |         |          | LESS CORE |
|--------------------------|---------------|-------------------------------|---------|----------|-----------|
|                          |               | PATENTED*                     | PREMIUM | STANDARD |           |
| <b>8T DEADBOLTS</b>      |               |                               |         |          |           |
| Single-keyed—turnknob    | K             | 292.00                        | 292.00  | 280.00   | 210.00    |
| Single-keyed—no turnknob | L             | 292.00                        | 292.00  | 280.00   | 210.00    |
| Non-keyed—turnknob       | KL            | N/A                           | N/A     | N/A      | 174.00    |
| Double-keyed—CS-standard | M             | 440.00                        | 440.00  | 416.00   | 276.00    |
| Single-keyed—classroom   | S             | 292.00                        | 292.00  | 280.00   | 210.00    |
| <b>7T DEADBOLTS</b>      |               |                               |         |          |           |
| Single-keyed—turnknob    | K             | 213.00                        | 213.00  | 201.00   | 131.00    |
| Single-keyed—no turnknob | L             | 213.00                        | 213.00  | 201.00   | 131.00    |
| Double-keyed             | M             | 349.00                        | 349.00  | 325.00   | 185.00    |

\* Patented pricing shown is for CORMAX patented keying system. Add \$20.00 for Best Preferred patented keying.

| EXTRA COST OPTIONS*                        | OPTION CODE         | ADD-ON |
|--|---------------------|--------|
| Satin finishes (per lock)                  | 606, 612, 613, etc. | 25.00  |
| Bright finishes (per lock) (8T only)       | 605, 611, 625, etc. | 25.00  |
| UltraShield antimicrobial finish (8T only) | 626AM, 630AM        | 38.00  |
| Concealed screws (8T only)                 | CS                  | 44.00  |
| Lead lined (8T only)                       | LL                  | 162.00 |
| High security strikes                      | S5                  | 35.00  |
| Security head screws (8T only)             | SH                  | 22.00  |
| Thick door (8T only)                       | Specify thickness   | 37.00  |
| Thin door (8T; M function only)            | Specify thickness   | 37.00  |

| PART DESCRIPTION                     | PART NUMBER | PART PRICE |
|--------------------------------------|-------------|------------|
| 2-3/8" Deadbolt tube                 | 8TD2B       | 49.00      |
| 2-3/4" Deadbolt tube                 | 8TD3B       | 49.00      |
| 2-3/8" Drive-in bolt                 | 8TD25       | 49.00      |
| 2-3/4" Drive-in bolt                 | 8TD35       | 49.00      |
| Std. deadbolt strike pkg.            | 8TSSTK      | 8.60       |
| ANSI deadbolt strike pkg.            | 8TS1        | 27.00      |
| Deadbolt lip strike pkg.             | 8TS4        | 8.60       |
| High security strike pkg. / deadbolt | 8TS5*       | 50.00      |

\* 8TS5 only available in 630 finish

ATTENTION: Lockets that secure both sides of the door (e.g., L and M functions) are controlled by building codes and the Life Safety Code. Delay in unlocking for rapid emergency exit could be hazardous or even fatal.



# 9KX SHELTER Cylindrical Locks

Federal Spec. 160

## How To Order

ANSI Series 4000

| 9KX   | 3                                    | 7   | R             | 14  | D                 | STK  | 626   | Options  |  |
|---|--------------------------------------|---|---------------|---|-------------------|--|---|--|--|
| Series  | Backset                              | Core Housing  | Function Code | Lever Style   | Rose Style        | Strike Package   | Finish  |  |  |
| 9KX   | 3 – 2-3/4"<br>4* – 3-3/4"<br>5* – 5" | 0 – Non-IC and LFIC competitive cylinder (less core)†<br>6 – 6-pin non-IC cylinder<br>7 – 7-pin housing; accepts all BEST cores | R             | 14 – Curved with return<br>15 – Contour angle with return<br>16 – Curved without return | D – 3-1/2" convex | STK – Standard<br>S3 – ANSI S3 7/8**<br>STK 7/8***<br>LS – Less strike<br>S3B* - ANSI (Strike w/ Plastic Box)<br>S3B 7/8* - ANSI (Strike w/ Plastic Box) | 626 690<br>622<br>626AM*<br><br>Satin*<br>606 612<br>613 619<br><br>Bright*<br>605 611<br>625 618 | 3/4* – 3/4" throw latch<br>AL/B* – Abrasive lever both sides<br>AL/O* – Abrasive lever outside<br>AL/I* – Abrasive lever inside<br>TL/B* – Tactile lever both sides<br>TL/O* – Tactile lever outside<br>TL/I* – Tactile lever inside<br>ATB - 2-3/4" Through bolt Prep<br>ATB2 - 2-5/8" Through bolt prep<br>FRL* – Full radius latch<br>LM – Lost motion<br>Thin Door* – 1-3/8" | OB* – non-IC zero bitted<br>KA* – non-IC keyed alike<br>KD* – non-IC keyed different<br>COR* – non-IC Corbin-Russwin<br>MED* – non-IC Medeco<br>SAR* – non-IC Sargent<br>SCH* – non-IC Schlage<br>YAL* – non-IC Yale<br>SARRC - LFIC Sargent<br>CORRC - LFIC Corbin<br>YALRC - LFIC Yale<br>SCHRC - LFIC Schlage<br>WS – Windstorm Label (NOA Miami-Dade County) |
| *Indicates extra cost. Must specify keymark and number of keys.<br>**S3 7/8 is the ANSI flat lip strike<br>***STK 7/8 is the standard flat lip strike |                                      |   |               |   |                   | Choose only one option: OB, KA, KD-use with core housing option 6 COR, MED, SAR, SCH, YAL, SCHRC-use with core housing option 0                          |   |  |  |

| FUNCTION DESCRIPTION          | FUNCTION CODE | COMPLETE WITH COMBINATED CORE |         |          | LESS CORE | NON-IC CYLINDER<br>OB, KA, KD |
|-------------------------------|---------------|-------------------------------|---------|----------|-----------|-------------------------------|
|                               |               | PATENTED*                     | PREMIUM | STANDARD |           |                               |
| Electromechanical:            |               |                               |         |          |           |                               |
| 9KX Standard Cylindrical Lock | R             | 817.00                        | 817.00  | 805.00   | 735.00    | 786.00                        |

\*Patented pricing shown is for CORMAX patented keying system. Add \$20.00 for BEST Preferred patented keying.

| EXTRA COST OPTIONS                     | OPTION CODE         | ADD-ON |
|--|---------------------|--------|
| Satin finishes (per lock)*             | 606, 612, 613, etc. | 19.00  |
| Bright finishes (per lock)*            | 605, 625, 629, etc. | 43.00  |
| UltraShield antimicrobial finish*      | 626AM               | 60.00  |
| Thin door 1-3/8"                       | 1-3/8"              | 151.00 |
| 3/4" throw latch*                      | 3/4                 | 31.00  |
| Special backsets*                      | 94K / 95K           | 21.00  |
| Abrasive lever both sides*             | AL/B                | 43.00  |
| Abrasive lever outside*                | AL/O                | 22.00  |
| Abrasive lever inside*                 | AL/I                | 22.00  |
| Tactile lever both sides*              | TL/B                | 84.00  |
| Tactile lever outside*                 | TL/O                | 43.00  |
| Tactile lever inside*                  | TL/I                | 43.00  |
| 7/8" Lip-to-center strike*             | S3 7/8 or STK 7/8   | 22.00  |
| Strike with plastic box*               | S3B or S3B 7/8      | 2.20   |
| Full radius latch*                     | FRL                 | 21.00  |
| Non-IC Corbin-Russwin (single keyed)** | COR                 | 6.60   |
| Non-IC Corbin-Russwin (double keyed)** | COR                 | 15.00  |
| Non-IC Medeco (single keyed)**         | MED                 | 6.60   |
| Non-IC Medeco (double keyed)**         | MED                 | 15.00  |
| Non-IC Sargent (single keyed)**        | SAR                 | 6.60   |
| Non-IC Sargent (double keyed)**        | SAR                 | 15.00  |
| Non-IC Schlage (single keyed)**        | SCH                 | 6.60   |
| Non-IC Schlage (double keyed)**        | SCH                 | 15.00  |
| Non-IC Yale (single keyed)**           | YAL                 | 6.60   |
| Non-IC Yale (double keyed)**           | YAL                 | 15.00  |

| PART DESCRIPTION  | PART NUMBER | PART PRICE |
|---|-------------|------------|
| 2-3/4" deadlocking latch  | 8KL3        | 79.00      |
| 3-3/4" deadlocking latch  | 8KL4        | 100.00     |
| 5" deadlocking latch  | 8KL5        | 100.00     |
| Standard strike package   | 8KS2        | 7.80       |
| ANSI strike package   | 8KS3        | 24.00      |
| Throw member 7-pin  | B54200      | 1.80       |
| SHELTER FOB   | SHX-FOB     | 158.00     |
| SHELTER Gateway   | SHX-GTW     | 3098.00    |
| SHELTER Repeater  | SHX-RPT     | 788.00     |
| SHELTER Repeater Pole Mount   | SHX-PLE     | 158.00     |
| SHELTER Gateway Power Pigtail Plug  | SHX-PTL     | 27.00      |
| SHELTER Omni-directional Gateway antenna with 20' plenum rated, low-loss, 20' cable | SHX-OMNI    | 1260.00    |
| SHELTER Cloud Software License  | SHX-SCS     | 800.00     |

\*Choose only one option: OB, KA, KD-use with core housing option 6. COR, MED, SAR, SCH, YAL, SCHRC-use with core housing option 0

\*\* These options do not come with a cylinder. The lock is just prepped for cylinders of these other manufacturers and comes with a throw member for that manufacturer's cylinder.



## W Series Electric Switch Locks

### How To Order

| 1W     | 7   | B1            | 626  | SWR            |
|--------|---|---------------|--|----------------|
| Series | Core Housing                              | Function code | Finish   | Optional Box** |
| 1W     | 7 – 7-pin housing; accepts all BEST cores | See below     | 626 690<br>Satin*<br>606 612<br>613 619<br>Bright*<br>605 611<br>625 | See below      |

\*Indicates extra cost option; see below.

\*\*Not all boxes are compatible with all switch locks. See the catalog for details.

| FUNCTION DESCRIPTION           | SWITCH TYPE | KEY POSITION 2*** | KEY POSITION 3*** | FUNCTION CODE | COMPLETE WITH COMBINATED CORE |         |          | LESS CORE |
|--------------------------------|-------------|-------------------|-------------------|---------------|-------------------------------|---------|----------|-----------|
|                                |             |                   |                   |               | PATENTED*                     | PREMIUM | STANDARD |           |
| <b>Maintained Switch Locks</b> |             |                   |                   |               |                               |         |          |           |
| Low voltage                    | SPDT        | 3 o'clock         | N/A               | A1            | 265.00                        | 265.00  | 253.00   | 183.00    |
| Single switch                  | SPDT        | 2 o'clock         | N/A               | B1            | 237.00                        | 237.00  | 225.00   | 155.00    |
| Single switch                  | SPDT        | 12 o'clock        | N/A               | B2            | 237.00                        | 237.00  | 225.00   | 155.00    |
| Single switch                  | SPST        | 5 o'clock         | 12 o'clock        | C2**          | 318.00                        | 318.00  | 306.00   | 236.00    |
| Toggle switch                  | DPST        | 2 o'clock         | N/A               | D2            | 292.00                        | 292.00  | 280.00   | 210.00    |
| Toggle switch                  | TPDT        | 3 o'clock         | 9 o'clock         | E2            | 296.00                        | 296.00  | 284.00   | 214.00    |
| Toggle switch                  | SPDT        | 2 o'clock         | 12 o'clock        | L2            | 324.00                        | 324.00  | 312.00   | 242.00    |
| Dual switch                    | 2 SPDT      | 3 o'clock         | N/A               | J1            | 312.00                        | 312.00  | 300.00   | 230.00    |
| Dual switch                    | 2 SPDT      | 12 o'clock        | N/A               | J2            | 350.00                        | 350.00  | 338.00   | 268.00    |
| <b>Momentary Switch Locks</b>  |             |                   |                   |               |                               |         |          |           |
| Single switch                  | SPDT        | 2 o'clock         | 12 o'clock        | B3            | 265.00                        | 265.00  | 253.00   | 183.00    |
| Dual switch                    | 2 SPDT      | 2 o'clock         | 12 o'clock        | J3            | 312.00                        | 312.00  | 300.00   | 230.00    |
| Toggle switch                  | DPDT        | 2 o'clock         | 10 o'clock        | K4            | 312.00                        | 312.00  | 300.00   | 230.00    |
| Dual switch                    | 2 SPDT      | 2 o'clock         | 10 o'clock        | P4            | 292.00                        | 292.00  | 280.00   | 210.00    |
| Quad switch                    | 4 SPDT      | 2 o'clock         | 10 o'clock        | R4            | 306.00                        | 306.00  | 294.00   | 224.00    |

\*Patented pricing shown is for CORMAX patented keying system. Add \$20.00 for BEST Preferred patented keying.

\*\*Supplied with OC1 box only (included in price).

\*\*\*Key position 1 for all switch locks is 12 o'clock except for the C2 function which is at 7 o'clock and the L2 function which is at 10 o'clock position.  
For all switch locks, the key is removable in the 12 o'clock position only.

| EXTRA COST OPTIONS*/OPTIONAL BOXES |                    |        |
|------------------------------------|--------------------|--------|
| DESCRIPTION                        | CODE               | PRICE  |
| Satin finishes                     | 606, 612, 613 etc. | 4.70   |
| Bright finishes                    | 605, 611, 625 etc. | 6.20   |
| Interior box                       | INT                | 55.00  |
| Standard octagon center mount      | OC1                | 54.00  |
| Deep octagon offset mount          | OC2                | 91.00  |
| Standard weather resistant box     | SWR                | 290.00 |

| PARTS                            |                      |       |
|----------------------------------|----------------------|-------|
| FUNCTION CODE                    | REPLACEMENT SWITCH # | PRICE |
| A1                               | S4A                  | 47.00 |
| B1, B2, B3, J1, J2, J3, P4, & R4 | S4B                  | 18.00 |
| C2                               | S4C                  | 83.00 |
| D2                               | S4D                  | 30.00 |
| E2                               | S4E                  | 73.00 |
| K4                               | S4K                  | 73.00 |
| L2                               | S4L                  | 62.00 |



## 45HW Series Electromechanical Mortise Locks

### How To Order

| 45HW   | 7  | DEL   | 14  | H  | 626  | RH                     |  |
|--------|--|---|---|--|--|------------------------|--|
| Series | Core Housing   | Function Code   | Lever Style   | Trim Style   | Finish   | Door Hand              | Options  |
| 45HW   | 0** – Less Core Housing<br>7 – 7-pin housing; accepts all BEST cores | Electrically-locked:***<br>DEL LEL<br>NXEL TDEL<br>TWEL WEL<br>Electrically-un-locked:***<br>DEU LEU<br>NXEU TDEU<br>TWEU WEU | Levers:<br>3 – Solid tube/return<br>12* – Solid tube/no return<br>14 – Curved/return<br>15 – Contour/angle return<br>16 – Curved/no return<br>17* – Gull wing<br>Knobs:<br>4 – Round<br>Decorative****<br>50–91 | H – 2-3/4" dia.<br>R – 2-3/4" dia.<br>S – 3-1/2" dia<br>J* – Wrought<br>M* – Forged<br>N* – Forged<br>(concealed cylinder; N trim invalid on non-keyed and double keyed functions) | 626 630<br>690 622 626AM*<br>630AM*<br>Satin*<br>606 612<br>613 619<br>Bright*<br>605 611<br>625 629 | RH<br>RHR<br>LH<br>LHR | C† - Pre-Terminated Quick Connect Plug<br>DS* – Door status monitor<br>IDH* – Integrated Door Hardware<br>LL* – Lead lined<br>LS* – Latch status monitor<br>RQE* – Request to exit<br>Thick door* – Specify thickness<br>7/8"* – Flat lip strike<br>VT* – Vandal Trim<br>12V – 12V Solenoid (24V is standard)<br>TAC/I* – Tactile Lever Inside<br>TAC/O* – Tactile lever Outside<br>TAC/B* – Tactile Lever Both<br>VIN* – Visual Indicator<br>SH* – Security Head Screws |

\* Indicates extra cost; see below.

†See Stanley Hinges & Door Accessories price book for Wire Harness product

\*\* Indicates cost deduction; see below.

\*\*\* Fail safe functions (EL) and fail secure functions (EU) include a Temperature Control Module (TCM) with the price of the lock.

\*\*\*\* Decorative levers are considered special order items that may have extended lead times. Consult factory for lead times.

Available decorative levers: 50-53, 55, 60, 62-63, 65, 69, 75, 79-81, and 89.

| FUNCTION DESCRIPTION                   | FUNCTION CODE | COMPLETE WITH COMBINATED CORE |         |          | LESS CORE |
|--|---------------|-------------------------------|---------|----------|-----------|
|  |               | PATENTED*                     | PREMIUM | STANDARD |           |
| <b>45HW Electro-mechanical:</b>        |               |                               |         |          |           |
| 45HW Single key, latch, fail secure    | DEU           | 1593.00                       | 1593.00 | 1581.00  | 1511.00   |
| 45HW Single key, latch, fail safe      | DEL           | 1593.00                       | 1593.00 | 1581.00  | 1511.00   |
| 45HW Double key, latch, fail secure    | WEU           | 1736.00                       | 1736.00 | 1712.00  | 1572.00   |
| 45HW Double key, latch, fail safe      | WEL           | 1736.00                       | 1736.00 | 1712.00  | 1572.00   |
| 45HW Keyless, latch, fail secure       | NXEU          | N/A                           | N/A     | N/A      | 1450.00   |
| 45HW Keyless, latch, fail safe         | NXEL          | N/A                           | N/A     | N/A      | 1450.00   |
| 45HW Single key, deadbolt, fail secure | TDEU          | 1624.00                       | 1624.00 | 1612.00  | 1542.00   |
| 45HW Single key, deadbolt, fail safe   | TDEL          | 1624.00                       | 1624.00 | 1612.00  | 1542.00   |
| 45HW Double key, deadbolt, fail secure | TWEU          | 1767.00                       | 1767.00 | 1743.00  | 1603.00   |
| 45HW Double key, deadbolt, fail safe   | TWEL          | 1767.00                       | 1767.00 | 1743.00  | 1603.00   |
| 45HW Keyless, deadbolt, fail secure    | LEU           | N/A                           | N/A     | N/A      | 1481.00   |
| 45HW Keyless, deadbolt, fail safe      | LEL           | N/A                           | N/A     | N/A      | 1481.00   |

\*Patented pricing shown is for CORMAX patented keying system. Add \$20.00 for BEST Preferred patented keying.

| EXTRA COST OPTIONS*              | OPTION CODE             | ADD-ON |
|----------------------------------|-------------------------|--------|
| Satin finishes (per lock)        | 606, 612, 613, 619 etc. | 31.00  |
| Bright finishes (per lock)       | 605, 611, 625, etc.     | 59.00  |
| UltraShield antimicrobial finish | 626AM, 630AM            | 61.00  |
| Wrought trim                     | J                       | 12.00  |
| Thick door                       | Specify thickness       | 85.00  |
| Lead lined                       | LL                      | 233.00 |
| Forged trim                      | M, N                    | 94.00  |
| 7/8" Lip-to-center strike        | 7/8 LTC                 | 22.00  |
| 12, 17 Lever Design              | 12, 17                  | 66.00  |
| Vandal trim - 630 finish***      | VT                      | 149.00 |
| Vandal trim - other finishes***  | VT                      | 114.00 |
| Visual Indicator                 | VIN                     | 44.00  |

\*\*Not available on #17 levers.

\*\*\*Available only with #14 and #15 levers. Only #14 lever complies with California State Fire Marshall Code.

| EXTRA COST OPTIONS*          | OPTION CODE | ADD-ON |
|------------------------------|-------------|--------|
| Request to exit              | RQE         | 43.00  |
| Integrated door hardware     | IDH         | 123.00 |
| Latch status monitor         | LS          | 90.00  |
| Door status monitor          | DS          | 123.00 |
| Tactile both levers/knobs**  | TAC/B       | 120.00 |
| Tactile outside lever/knob** | TAC/O       | 61.00  |
| Tactile inside lever/knob**  | TAC/I       | 61.00  |
| Decorative Lever Design      | 50 to 91    | 211.00 |
| Security Head Screws         | SH          | 22.00  |

| **COST DEDUCTIONS                                 | OPTION CODE | DEDUCT |
|---|-------------|--------|
| Less cylinder option (Deduct from complete price) | 0           | 61.00  |



## 47HW Series High Security Electromechanical Mortise Locks

### How To Order

| 47HW   | 7   | DEL   | 14  | H   | 626                            | RH                     |  |
|--------|---|---|---|---|--------------------------------|------------------------|--|
| Series | Core Housing                              | Function Code   | Lever Style   | Trim Style  | Finish                         | Door Hand              | Options  |
| 47HW   | 7 – 7-pin housing; accepts all BEST cores | Electrically-locked:***<br>DEL<br>TDEL<br>TWEL<br>WEL<br>Electrically-un-locked:***<br>DEU<br>TDEU<br>TWEU<br>WEU | Levers:<br>3 – Solid tube/return<br>12* – Solid tube/no return<br>14 – Curved/return<br>15 – Contour/angle return<br>16 – Curved/no return<br>17* – Gull wing<br>Knobs:<br>4 – Round<br>Decorative****<br>50-91 | M – forged<br>H****<br>– 2-3/4" dia.<br>R****<br>– 2-3/4" dia.<br>S****<br>– 3-1/2" dia | 626<br>630<br>626AM*<br>630AM* | RH<br>RHR<br>LH<br>LHR | C' - Pre-Terminated Quick Connect Plug<br>DS* – Door status monitor<br>IDH* – Integrated Door Hardware<br>LS* – Latch status monitor<br>RQE* – Request to exit<br>Thick door* – (Specify thickness)<br>7/8"* – Flat lip strike<br>VT* – Vandal Trim<br>12V – 12V Solenoid (24V is standard)<br>K – Non-UL Cylinder<br>TAC/I* – Tactile Lever Inside<br>TAC/O* – Tactile lever Outside<br>TAC/B* – Tactile Lever Both<br>LL* – Lead Lined |

\* Indicates extra cost; see below.

\*See Stanley Hinges & Door Accessories price book for Wire Harness product

\*\* Indicates cost deduction; see below.

\*\*\* Fail safe functions (EL) and fail secure functions (EU) include a Temperature Control Module (TCM) with the price of the lock.

\*\*\*\* Decorative levers are considered special order items that may have extended lead times. Consult factory for lead times. Available decorative levers: 50-53, 55, 60, 62-63, 65, 69, 75, 79-81, and 89.

\*\*\*\*\* To maintain the UL437 standard for high security locks, order only M trim. Using H, R or S trim does not meet the UL437 standard.

| FUNCTION DESCRIPTION                   | FUNCTION CODE | COMPLETE WITH COMBINATED CORE |         |          | LESS CORE  |
|--|---------------|-------------------------------|---------|----------|--|
|  |               | PATENTED*                     | PREMIUM | STANDARD |  |
| <b>47HW Electro-mechanical:</b>        |               |                               |         |          |  |
| 47HW Single key, latch, fail secure    | DEU           | 1622.00                       | N/A     | 1615.00  | <b>NOTE: 47HW Series must be keyed at the factory unless the K Option is ordered</b> |
| 47HW Single key, latch, fail safe      | DEL           | 1622.00                       | N/A     | 1615.00  |  |
| 47HW Double key, latch, fail secure    | WEU           | 1853.00                       | N/A     | 1839.00  |  |
| 47HW Double key, latch, fail safe      | WEL           | 1853.00                       | N/A     | 1839.00  |  |
| 47HW Single key, deadbolt, fail secure | TDEU          | 1653.00                       | N/A     | 1646.00  |  |
| 47HW Single key, deadbolt, fail safe   | TDEL          | 1653.00                       | N/A     | 1646.00  |  |
| 47HW Double key, deadbolt, fail secure | TWEU          | 1872.00                       | N/A     | 1858.00  |  |
| 47HW Double key, deadbolt, fail safe   | TWEL          | 1872.00                       | N/A     | 1858.00  |  |

\*Pricing reflects the 5C high security core for standard and the 5CM high security CORMAX core for patented.

| EXTRA COST OPTIONS*              |                   | ADD-ON |
|----------------------------------|-------------------|--------|
| Thick door                       | Specify thickness | 85.00  |
| 7/8" Lip-to-center strike        | 7/8 LTC           | 22.00  |
| 12, 17 Lever Design              | 12, 17            | 66.00  |
| UltraShield antimicrobial finish | 626AM, 630AM      | 61.00  |
| Decorative Lever Design          | 50-91             | 211.00 |
| Vandal trim - 630 finish***      | VT                | 149.00 |
| Vandal trim - other finishes***  | VT                | 114.00 |
| Request to exit                  | RQE               | 43.00  |
| Integrated door hardware         | IDH               | 123.00 |
| Latch status monitor             | LS                | 90.00  |
| Door status monitor              | DS                | 123.00 |
| Lead Lined                       | LL                | 233.00 |

\*\*Not available on #17 levers.

\*\*\*Available only with #14 and #15 levers.

Only #14 lever complies with California State Fire Marshall Code.

| EXTRA COST OPTIONS*          | OPTION CODE | ADD-ON |
|------------------------------|-------------|--------|
| Tactile both levers/knobs**  | TAC/B       | 120.00 |
| Tactile outside lever/knob** | TAC/O       | 61.00  |
| Tactile inside lever/knob**  | TAC/I       | 61.00  |

Security Head Screws provided standard on 47HW

ATTENTION: Locksets that secure both sides of the door (e.g., WEL and WEU) are controlled by building codes and the Life Safety Code. Delay in unlocking for rapid emergency exit could be hazardous or even fatal.



## 8KW/9KW Series Electromechanical Cylindrical Locks

### How To Order

| 8KW    | 3   | 7   | DEL  | 4                      | C  | STK                         | 626   |   |
|--------|---|---|--|------------------------|--|-----------------------------|---|---|
| Series | Backset                                       | Core Housing                              | Function Code  | Knob Style             | Rose Style   | Strike Package              | Finish  | Options   |
| 8KW    | 3 –<br>2-3/4”<br>4* –<br>3-3/4”<br>5* –<br>5” | 7 – 7-pin housing; accepts all BEST cores | DEL** – Electrically locked<br>DEU** – Electrically unlocked | 4 – Round<br>6 – Tulip | C – 3” convex<br>D – 3-1/2” convex<br>K – 3” convex<br>L – 3-1/2” convex | STK – Standard<br>S3 – ANSI | 626 690<br>626AM*<br>Satin*<br>606 612<br>613<br>619 622<br>Bright*<br>605 611<br>625 | BRK – Break-away (keyed only)<br>C* - Pre-Terminated Quick Connect Plug<br>LL* – Lead lined<br>SH* – Security head screws<br>3/4* – 3/4” throw<br>RQE* – Request to Exit<br>Thin Door* – 1-3/8”<br>TAC/I* – Tactile Lever Inside<br>TAC/O* – Tactile lever Outside<br>TAC/B* – Tactile Lever Both<br>12V - Specify 12V System:<br>Standard voltage is 24V |

\* Indicates extra cost; see below.

\*\* Fail safe functions (EL) and fail secure functions (EU) include a Temperature Control Module (TCM) with the price of the lock.

†See Stanley Hinges & Door Accessories price book for Wire Harness product

| 9KW    | 3   | 7  | DEL  | 15  | C  | S3  | 626   |   |
|--------|---|--|--|---|--|---|---|---|
| Series | Backset                                       | Core Housing   | Function Code  | Lever Style   | Rose Style   | Strike Package  | Finish  | Options   |
| 9KW    | 3 –<br>2-3/4”<br>4* –<br>3-3/4”<br>5* –<br>5” | 0*** -<br>Non-IC and<br>LFIC competitive<br>cylinder<br>(less core)<br>6** – 6 pin<br>Non-IC<br>Cylinder<br>7 – 7-pin<br>Housing;<br>accepts all<br>BEST cores | DEL – Electrically locked****<br>DEU – Electrically unlocked**** | 14 – Curved with return<br>15 – Contour with angle return<br>16 – Curved with no return | C – 3” convex<br>D – 3-1/3” convex<br>K – 3” convex no ring<br>L – 3-1/2” convex no ring | STK – Standard<br>S3 – ANSI<br>S3 7/8* – 7/8 Lip to Center strike<br>LS – Less Strike<br>S3B* - ANSI (Stike w/ Plastic Box)<br>S3B 7/8* - ANSI (Stike w/ Plastic Box) | 626 690<br>626AM*<br>Satin*<br>606 612<br>613<br>619 622<br>Bright*<br>605 611<br>625 | 3/4* – 3/4” throw latch<br>ATB - 2-3/4” Through bolt Prep<br>ATB2 - 2-5/8” Through bolt prep<br>C - Pre-Terminated Quick Connect Plug<br>LL* – Lead lined<br>SH* – Security head screws<br>LM – Lost motion<br>RQE* – Request to Exit<br>Thin Door* – 1-3/8”<br>AL/O* – Abrasive Lever Outside<br>AL/I* – Abrasive Lever Inside<br>AL/B* – Abrasive Lever Both<br>TL/O* – Tactile Lever Outside<br>TL/I* – Tactile Lever Inside<br>TL/B* – Tactile Lever Both<br>FRL – Full Radius Latch<br>OB** – Non-IC zero-bitted<br>KA** – Non-IC keyed alike<br>KD** – Non-IC keyed different<br>COR*** – Non-IC Corbin-Russwin<br>MED*** – Non-IC Medeco<br>SAR*** – Non-IC Sargent<br>SCH*** – Non-IC Schlage<br>YAL*** – Non-IC Yale<br>SARRC*** - LFIC Sargent<br>CORRC*** - LFIC Corbin<br>YALRC*** - LFIC Yale<br>SCHRC*** - LFIC Schlage<br>(14 & 15 lever only) 12V - Specify 12V System: Standard voltage is 24V |

\* Indicates extra cost option.

\*\* Six-pin cylinder in Schlage “C” keyway included with OB, KA, and KD options. Must specify “6” for core housing.

\*\*\* Cylinder not included with COR, MED, SAR, SCH, YAL, CORRC, YALRC, SARRC, or SCHRC options. Must specify “0” for core housing.

\*\*\*\* Fail safe functions (EL) and fail secure functions (EU) include a Temperature Control Module (TCM) with the price of the lock.





## 8KW/9KW Series Electromechanical Cylindrical Locks (continued)

| FUNCTION DESCRIPTION         | FUNCTION CODE | COMPLETE WITH COMBINATION CORE |         |          | LESS CORE | NON-IC CYLINDER<br>0B, KA, KD |
|------------------------------|---------------|--------------------------------|---------|----------|-----------|-------------------------------|
|                              |               | PATENTED*                      | PREMIUM | STANDARD |           |                               |
| <b>Electromechanical:</b>    |               |                                |         |          |           |                               |
| 8KW Elect. locked / unlocked | DEL, DEU      | 1170.00                        | 1170.00 | 1158.00  | 1088.00   | N/A                           |
| 9KW Elect. locked / unlocked | DEL, DEU      | 1046.00                        | 1046.00 | 1034.00  | 964.00    | 1015.00                       |

\*Patented pricing shown is for CORMAX patented keying system. Add \$20.00 for BEST Preferred patented keying.

| EXTRA COST OPTIONS*              | OPTION CODE           | ADD-ON |
|----------------------------------|-----------------------|--------|
| Satin finishes (per lock)        | 606, 612, 613, etc.   | 19.00  |
| Bright finishes (per lock)       | 605, 611, 625, etc.   | 43.00  |
| UltraShield antimicrobial finish | 626AM                 | 60.00  |
| Thin door 1-3/8"                 | 1-3/8"                | 80.00  |
| 3/4" throw latch                 | 3/4                   | 31.00  |
| Special backsets                 | 84K / 85K / 94K / 95K | 21.00  |
| Lead lined                       | LL                    | 228.00 |
| Security head screws             | SH                    | 22.00  |
| Tactile knob both sides          | TAC/B                 | 84.00  |
| Tactile knob outside             | TAC/O                 | 43.00  |
| Tactile knob inside              | TAC/I                 | 43.00  |
| Abrasive lever both sides        | AL/B                  | 43.00  |
| Abrasive lever outside           | AL/O                  | 22.00  |
| Abrasive lever inside            | AL/I                  | 22.00  |
| Tactile lever both sides         | TL/B                  | 84.00  |
| Full radius latch                | FRL                   | 21.00  |
| Tactile lever outside            | TL/O                  | 43.00  |
| Tactile lever inside             | TL/I                  | 43.00  |
| 7/8" Lip-to-center strike        | S3 7/8                | 22.00  |
| Strike with plastic box          | S3B or S3B 7/8        | 2.20   |
| Request to exit                  | RQE                   | 166.00 |

| PART DESCRIPTION           | PART NUMBER       | PRICE  |
|----------------------------|-------------------|--------|
| 2-3/4" deadlocking latch   | 8KL3              | 79.00  |
| 3-3/4" deadlocking latch   | 8KL4              | 100.00 |
| 5" deadlocking latch       | 8KL5              | 100.00 |
| Standard strike package    | 8KS2              | 7.80   |
| ANSI strike package        | 8KS3              | 24.00  |
| Throw member 6-pin / 7-pin | 71217417 / B54200 | 1.80   |
| Breakaway knob driver      | B54856            | 8.60   |

## Electromechanical Lock Accessories

| DESCRIPTION                          | CATALOG NO. | PRICE  |
|--------------------------------------|-------------|--------|
| Transformer                          | 8W599       | 163.00 |
| AC to DC converter                   | 8WCON       | 63.00  |
| Narrow plate (push button)           | 8WBU-1-N    | 111.00 |
| Standard plate (push button)         | 8WBU-1-A    | 111.00 |
| Universal temperature control module | B87034      | 179.00 |



## Electric Strikes

| DESCRIPTION   | CATALOG NO.  | PRICE  |
|---|--------------|--------|
| <b>"3/4" Surface Mount Rim Strike"</b>                                  |              |        |
| 3/4" Surface Mount Rim Strike   | BES-0162     | 525.00 |
| Fire-Rated 3/4" Surface Mount Rim Strike                                | BES-F0162    | 694.00 |
| 3/4" Surface Mount Rim Strike with Latch Monitor                        | BES-0162LM   | 594.00 |
| Fire-Rated 3/4" Surface Mount Rim Strike with Latch Monitor             | BES-F0162LM  | 723.00 |
| <b>"1/2" Surface Mount Rim Strike"</b>                                  |              |        |
| 1/2" Surface Mount Rim Strike   | BES-0563     | 550.00 |
| 1/2" Surface Mount Rim Strike with Latch Monitor                        | BES-0563LM   | 634.00 |
| <b>All-In-One-Strike</b>  |              |        |
| Fire-Rated All-In-One-Strike-Fail-Secure                                | BES-F2164    | 634.00 |
| All-In-One-Strike-Fail Safe   | BES-2364     | 634.00 |
| <b>Centerline Strike-4 Series</b>                                       |              |        |
| Fail Secure 12VAC/VDC   | BES-4105U    | 450.00 |
| Fail Secure 24VAC/VDC   | BES-4108U    | 450.00 |
| Fail Safe 12VDC   | BES-4306U    | 450.00 |
| Fail Safe 24VDC   | BES-4309U    | 450.00 |
| Fire-Rated Centerline Strike-Fail Secure 04 Faceplate 12VAC/VDC         | BES-F41045   | 435.00 |
| Fire-Rated Centerline Strike-Fail Secure 04 Faceplate 24VAC/VDC         | BES-F41048   | 435.00 |
| Fire-Rated Centerline Strike-Fail Secure 14 Faceplate 12VAC/VDC         | BES-F41145   | 435.00 |
| Fire-Rated Centerline Strike-Fail Secure 14 Faceplate 24VAC/VDC         | BES-F41148   | 435.00 |
| <b>Centerline Strike-6 Series</b>                                       |              |        |
| Standard Profile Universal-Multiple Faceplates                          | BES-S65U     | 254.00 |
| Low Profile Universal-Multiple Faceplates                               | BES-L65U     | 254.00 |
| Standard Profile Universal-Multiple Faceplates-Latch and Keeper Monitor | BES-S65ULMKM | 311.00 |
| Low Profile Universal-Multiple Faceplates-Latch and Keeper Monitor      | BES-L65ULMKM | 311.00 |

## Electric Strike Accessories

| DESCRIPTION   | CATALOG NO. | PRICE  |
|---|-------------|--------|
| <b>"3/4" Surface Mount Rim Strike"</b>                  |             |        |
| Heat Reducer for Continuous Duty                        | BES-ICEPK   | 99.00  |
| Strike Marking Template Kit                             | BES-SMT01   | 61.00  |
| "Plug-in Latch Monitor Kit (2A @ 24VDC).                | BES-F2LM    | 74.00  |
| Improved Design to Accommodate 1/2" - 3/4" Latch Throw" | BES-LEK01   | 77.00  |
| 1" Lip Extension Kit for Retrofit                       | BES-LEK02   | 89.00  |
| 2" Lip Extension Kit for Retrofit                       | BES-LEK03   | 103.00 |
| 3" Lip Extension Kit for Retrofit                       | BES-LEKL601 | 68.00  |
| 1" Lip Extension Kit for Retrofit (Low Profile)         | BES-LEKL602 | 80.00  |
| 2" Lip Extension Kit for Retrofit (Low Profile)         | BES-LEKL603 | 93.00  |



## Electromagnetic Locks

| DESCRIPTION  | CATALOG NO.    | PRICE    |
|--|----------------|----------|
| <b>Single Mag</b>  |                |          |
| For Outswinging Interior or Perimeter Doors  | BML-8310       | 557.00   |
| For Outswinging Interior or Perimeter Doors with Security Condition Sensor                               | BML-8310SCS    | 680.00   |
| For Outswinging Interior or Perimeter Doors with Door Status Sensor                                      | BML-8310DSS    | 654.00   |
| For Outswinging Interior or Perimeter Doors with Door Status Sensor and Security Condition Sensor        | BML-8310DSSSCS | 759.00   |
| <b>Double Mag</b>  |                |          |
| For Outswinging Interior or Perimeter Doors  | BML-8320       | 1,114.00 |
| For Outswinging Interior or Perimeter Doors with Security Condition Sensor                               | BML-8320SCS    | 1,357.00 |
| For Outswinging Interior or Perimeter Doors with Door Status Sensor                                      | BML-8320DSS    | 1,304.00 |
| For Outswinging Interior or Perimeter Doors with Door Status Sensor and Security Condition Sensor        | BML-8320DSSSCS | 1,520.00 |
| <b>Delayed Egress Mag</b>  |                |          |
| For Single Outswinging Interior or Perimeter Doors   | BML-DE8310     | 1,357.00 |
| For Single Outswinging Interior or Perimeter Doors with Sounder  | BML-DE8310S    | 1,561.00 |
| <b>Mortise MiniMag</b>   |                |          |
| For Sliding Doors  | BML-8360       | 464.00   |
| <b>Surface MiniMag</b>   |                |          |
| For Single Outswinging Interior or Perimeter Doors   | BML-8371       | 416.00   |
| For Single Outswinging Interior or Perimeter Doors with Security Condition Sensor                        | BML-8371SCS    | 486.00   |
| For Single Outswinging Interior or Perimeter Doors with Door Status Sensor                               | BML-8371DSS    | 469.00   |
| For Single Outswinging Interior or Perimeter Doors with Door Status Sensor and Security Condition Sensor | BML-8371DSSSCS | 540.00   |
| <b>Surface MiniMag</b>   |                |          |
| For Double Outswinging Interior or Perimeter Doors   | BML-8372       | 830.00   |
| For Double Outswinging Interior or Perimeter Doors with Security Condition Sensor                        | BML-8372SCS    | 971.00   |
| For Double Outswinging Interior or Perimeter Doors with Door Status Sensor                               | BML-8372DSS    | 937.00   |
| For Double Outswinging Interior or Perimeter Doors with Door Status Sensor and Security Condition Sensor | BML-8372DSSSCS | 1,080.00 |
| <b>GateMag</b>   |                |          |
| For Interior or Exterior Perimeter Gates   | BML-8380       | 570.00   |

## Electromagnetic Lock Accessories

| DESCRIPTION                            | CATALOG NO. | PRICE  |
|--|-------------|--------|
| 8310 Z Bracket Kit                     | BML-TJ10    | 170.00 |
| 8320 Z Bracket Bit                     | BML-TJ20    | 340.00 |
| 8371 Z Bracket Bit                     | BML-TJ71    | 170.00 |
| 8372 Z Bracket Kit                     | BML-TJ72    | 340.00 |
| 8380 Z Bracket Kit                     | BML-TJ80    | 137.00 |
| 1/2" (13mm) 32 8310 Glass Door Bracket | BML-GB8112  | 195.00 |
| 3/4" (19mm) 32 8310 Glass Door Bracket | BML-GB8134  | 195.00 |
| 1/2" (13mm) 32 8320 Glass Door Bracket | BML-GB8212  | 388.00 |
| 3/4" (19mm) 32 8320 Glass Door Bracket | BML-GB8234  | 381.00 |
| 1/2" (13mm) 32 8371 Glass Door Bracket | BML-GB7112  | 195.00 |
| 3/4" (19mm) 32 8371 Glass Door Bracket | BML-GB7134  | 195.00 |



## Electromagnetic Lock Accessories (continued)

| DESCRIPTION                                      | CATALOG NO. | PRICE  |
|--|-------------|--------|
| 1/2" (13mm) 32 8372 Glass Door Bracket           | BML-GB7212  | 388.00 |
| 3/4" (19mm) 32 8372 Glass Door Bracket           | BML-GB7234  | 388.00 |
| 3/8" (9.5mm) Steel Split Armature Plate for 8310 | BML-SA138   | 91.00  |
| 5/8" (16mm) Steel Split Armature Plate for 8310  | BML-SA158   | 91.00  |
| Armature Plate Holder for 8310                   | BML-AH10    | 96.00  |
| Armature Plate Holder for 8310xDSS               | BML-AH15    | 38.00  |
| Armature Plate Holder for 8320                   | BML-AH20    | 190.00 |
| Armature Plate Holder for 8320xDSS               | BML-AH25    | 74.00  |
| Armature Plate Holder for 8371                   | BML-AH71    | 96.00  |
| Armature Plate Holder for 8372                   | BML-AH72    | 190.00 |

## Electronic Lock Software & Accessories

For Wi-Q Technology Wireless software, accessories and locks, see pages 89-94

| DESCRIPTION  | PART NUMBER | PRICE    |
|--|-------------|----------|
| <b>Readers</b>   |             |          |
| Magnetic card access reader – 12VDC, track 2, weatherized (no keypad), black (MR-5)                                      | 360120WBK   | 537.00   |
| Dual validation (magnetic stripe & keypad) reader – 12VDC, track 2, weatherized, black case (MR-20), with tamper contact | 310120WBKOT | 1029.00  |
| <b>Cards</b>   |             |          |
| <b>MAGNETIC STRIPE CARDS Non-Encoded:</b>  |             |          |
| PVC (box of 500)   | VPA-PVC     | 2,200.00 |
| <b>Electronic Lock Accessories (Continued)</b>   |             |          |
| <b>REPLACEMENT PARTS:</b>  |             |          |
| Shrink wrap battery pack & foam*   | VPD-BATT    | 23.00    |
| Replacement battery pack   | VPD-BB      | 39.00    |
| 4 Cell Battery holder for new style 2 piece I/S escutcheon offline products  | C83511      | 46.00    |
| 8 Cell Battery holder for new style 2 piece I/S escutcheon offline products  | C83522      | 80.00    |
| Extended life battery door cover   | B62129      | 30.00    |
| <b>SERVICE EQUIPMENT:</b>  |             |          |
| Offline lock programming cable   | BASDCAB     | 198.00   |
| Magnetic Card Encoder  | MSR20633BA  | 3820.00  |
| Transport Programming Device   | SES-NetBook | 2237.00  |
| Transport Memory Drive   | SES-MEM     | 88.00    |
| Transport USB to Serial Adapter  | SES-USB     | 108.00   |
| Transport connector/adaptor (no cable, used to connect SES-USB to BASDCAB)   | SES-DB9CON  | 25.00    |
| Transport cable adaptor (6' Cable adaptor)   | SES-DB9CAB  | 46.00    |
| Power supply – 12 or 24 VDC, 2.5A output, 120 VAC input, UL  | AL300ULX    | 645.00   |
| Backup battery for power supply, 12 VDC, 12 AH   | NP12A12V    | 207.00   |
| Standard driver bit  | VPD-T15     | 30.00    |
| McGard driver bit  | VPD-HS-DRVR | 38.00    |
| McGard battery door screw (specify finish)   | VPD-HS-SCRW | 38.00    |
| Cleaning cards (box of 50)   | VPDCLN      | 188.00   |

| Offline G | Offline V | Keypad EZ | IDH MAX |
|-----------|-----------|-----------|---------|
| G         | BV        | Z         | M       |
|           |           |           |         |
|           |           |           |         |
|           |           |           |         |
|           |           |           |         |
| X         | X         |           | X       |
|           |           |           |         |
|           |           |           |         |
|           |           |           |         |
| X         | X         | X         |         |
| X         | X         | X         |         |
| X         | X         | X         |         |
| X         | X         | X         |         |
|           |           |           |         |
|           |           |           |         |
| X         | X         |           |         |
| X         | X         |           | X       |
| X         | X         |           |         |
| X         | X         |           |         |
| X         | X         |           |         |
| X         | X         |           |         |
| X         | X         | X         | X       |
| X         | X         | X         | X       |
| X         | X         | X         | X       |
| X         | X         |           | X       |

\*VPD-BATT used with legacy V Series locks only



## 45HZ Keypad EZ Mortise Locks

### How To Order

| 45HZ   | 7  | TV   | 15  | KP          | 626   | RH                       |  |
|--------|--|--|---|-------------|---|--------------------------|--|
| Series | Core Housing   | Function Code  | Lever Style   | Trim Style  | Finish  | Door Hand                | Options  |
| 45HZ   | 0** – Less Core Housing<br>7 – 7-pin housing; accepts all BEST cores | DV – Latch with key<br>TV – Deadbolt with key<br>NV – Latch without key<br>LV – Deadbolt without key | Levers:<br>3 – Solid tube/return<br>12* – Solid tube/no return<br>14 – Curved/return<br>15 – Contour/angle return<br>16 – Curved/no return<br>17* – Gull wing<br>4 – Round Knob<br>Decorative*<br>50-91 | KP – Keypad | 626 690 626AM*<br>– Antimicrobial<br><br>Satin*<br>606 612<br>613 619<br>622<br><br>Bright*<br>605 611<br>618 625 | RH<br>RHRB<br>LH<br>LHRB | 8CE* – 8-cell battery holder assy with batteries<br>4SW – 4-cell shrink wrap battery<br>P2*** – Phillips head screws<br>Thick Door* – Specify thickness<br>7/8"* – Flat lip strike<br>TAC/I* – Tactile Lever Inside<br>TAC/O* – Tactile lever Outside<br>TAC/B* – Tactile Lever Both<br>WS – Windstorm Label (NOA Miami-Dade County) |

\* Indicates extra cost; see below.

\*\* Indicates cost deduction.

\*\*\* T15 Torx security screws are supplied standard.

| DESCRIPTION                     | FUNCTION CODE | COMPLETE WITH COMBINATED CORE |         |          | LESS CORE |
|---------------------------------|---------------|-------------------------------|---------|----------|-----------|
|                                 |               | PATENTED*                     | PREMIUM | STANDARD |           |
| <b>KEYPAD EZ MORTISE LOCKS:</b> |               |                               |         |          |           |
| 45HZ - Single Keyed Latch       | DV            | 1391.00                       | 1391.00 | 1379.00  | 1309.00   |
| 45HZ - Single Keyed Deadbolt    | TV            | 1420.00                       | 1420.00 | 1408.00  | 1338.00   |
| 45HZ - Non-keyed Latch          | NV            | N/A                           | N/A     | N/A      | 1248.00   |
| 45HZ - Non-keyed Deadbolt       | LV            | N/A                           | N/A     | N/A      | 1277.00   |

\*Patented pricing shown is for CORMAX patented keying system. Add \$20.00 for BEST Preferred patented keying.

| EXTRA COST OPTIONS*              | OPTION CODE             | ADD-ON |
|----------------------------------|-------------------------|--------|
| Satin finishes (per lock)        | 606, 612, 613, 619 etc. | 59.00  |
| Bright finishes (per lock)       | 605, 611, 625, etc.     | 115.00 |
| UltraShield antimicrobial finish | 626AM                   | 127.00 |
| Thick door                       | Specify thickness       | 85.00  |
| Tactile both levers/knobs**      | TAC/B                   | 120.00 |
| Tactile outside lever/knob**     | TAC/O                   | 61.00  |
| Tactile inside lever/knob**      | TAC/I                   | 61.00  |
| 7/8" Lip-to-center strike        | 7/8 LTC                 | 22.00  |
| 12, 17 Lever Design              | 12, 17                  | 66.00  |
| Decorative Lever Design          | 50-91                   | 211.00 |
| Extended Life Battery            | 8CE                     | 68.00  |

\*\* Not available on #17 levers.

| **COST DEDUCTIONS                                 | OPTION CODE | DEDUCT |
|---|-------------|--------|
| Less cylinder option (Deduct from complete price) | 0           | 61.00  |



## 9KZ Keypad EZ Cylindrical Locks

### How To Order

| 9KZ    | 3                                    | 7   | DV            | 15   | KP          | STK   | 626   |  |
|--------|--------------------------------------|---|---------------|--|-------------|---|---|--|
| Series | Backset                              | Core Housing  | Function Code | Lever Style  | Trim Style  | Strike Package  | Finish  | Options  |
| 9KZ    | 3 – 2-3/4"<br>4* – 3-3/4"<br>5* – 5" | 0*** – Non-IC and LFIC competitive cylinder (less core)<br>6** – 6 pin non-IC cylinder<br>7 – 7-pin housing; accepts all BEST cores | DV - With Key | 14 – Curved with return<br>15 – Contour angle return<br>16 – Curved with no return<br>4 – Round Knob | KP – Keypad | STK - Standard<br>S3 - ANSI<br>S3 - 7/8" Lip to Center Strike<br>S3B* - ANSI (Strike w/ Plastic Box)<br>S3B 7/8* - ANSI (Strike w/ Plastic Box) | 626 690<br>626AM*<br><br>Satin*<br>606 612<br>613 619<br>622<br><br>Bright*<br>605 611<br>618 625 | 8CE* – 8 cell battery holder assy with batteries<br>4SW – 4 cell shrink wrap battery<br>P2**** – Phillips head screws<br>LM – Lost motion<br>3/4* – 3/4" throw latch<br>FRL – Full Radius Latch<br>OB* – non-IC zero-bitted<br>KA* – non-IC keyed alike<br>KD* – non-IC keyed different<br>COR*** – Non IC Corbin-Russwin<br>MED*** – Non IC Medeco<br>SAR*** – Non IC Sargent<br>SCH*** – Non IC Schlage<br>YAL*** – Non IC Yale<br>SARRC*** - LFIC Sargent<br>CORRC*** - LFIC Corbin<br>YALRC*** - LFIC Yale<br>SCHRC*** - LFIC Schlage<br>AL/O* – Abrasive Lever Outside<br>AL/I* – Abrasive Lever Inside<br>AL/B* – Abrasive Lever Both<br>TL/O* – Tactile Lever Outside<br>TL/I* – Tactile Lever Inside<br>TL/B* – Tactile Lever Both<br>WS – Windstorm Label (NOA Miami-Dade County) |

\* Indicates extra cost option.

\*\* Six-pin cylinder in Schlage "C" keyway included with OB, KA, and KD options. Must specify "6" for core housing.

\*\*\* Cylinder not included with COR, MED, SAR, SCH, YAL, CORRC, YALRC, SARRC, or SCHRC options. Must specify "0" for core housing.

\*\*\*\* T15 Torx security screws are supplied standard.

| FUNCTION DESCRIPTION               | FUNCTION CODE | COMPLETE WITH COMBINED CORE |         |          | LESS CORE | NON-IC CYLINDER<br>OB, KA, KD |
|------------------------------------|---------------|-----------------------------|---------|----------|-----------|-------------------------------|
|                                    |               | PATENTED*                   | PREMIUM | STANDARD |           |                               |
| <b>KEYPAD EZ CYLINDRICAL LOCK:</b> |               |                             |         |          |           |                               |
| 9KZ - Single keyed lock            | DV            | 1193.00                     | 1193.00 | 1181.00  | 1111.00   | 1162.00                       |

\*Patented pricing shown is for CORMAX patented keying system. Add \$20.00 for BEST Preferred patented keying.

| EXTRA COST OPTIONS*              | OPTION CODE         | ADD-ON |
|----------------------------------|---------------------|--------|
| Satin finishes (per lock)        | 606, 612, 613, etc. | 59.00  |
| Bright finishes (per lock)       | 605, 625, 629, etc. | 115.00 |
| UltraShield antimicrobial finish | 626AM               | 127.00 |
| 3/4" throw latch                 | 3/4                 | 31.00  |
| Special backsets                 | 94KZ / 95KZ         | 21.00  |
| Abrasive lever both sides        | AL/B                | 43.00  |
| Abrasive lever outside           | AL/O                | 22.00  |
| Abrasive lever inside            | AL/I                | 22.00  |
| Tactile lever both sides         | TL/B                | 84.00  |
| Tactile lever outside            | TL/O                | 43.00  |
| Tactile lever inside             | TL/I                | 43.00  |
| 7/8" Lip-to-center strike        | S3 7/8              | 22.00  |
| Strike with plastic box          | S3B or S3B 7/8      | 2.20   |
| Extended Life Battery            | 8CE                 | 68.00  |
| Full radius latch                | FRL                 | 21.00  |

| PART DESCRIPTION           | PART NUMBER       | PRICE  |
|----------------------------|-------------------|--------|
| 2-3/4" deadlocking latch   | 8KL3              | 79.00  |
| 3-3/4" deadlocking latch   | 8KL4              | 100.00 |
| 5" deadlocking latch       | 8KL5              | 100.00 |
| Standard strike package    | 8KS2              | 7.80   |
| ANSI strike package        | 8KS3              | 24.00  |
| Throw member 6-pin / 7-pin | 71217417 / B54200 | 1.80   |



# EXZ Keypad EZ Exit Trim

## How To Order

| EXZ    | 7  | EV                                  | 15  | KP           | 626  | RHR        | PH2   | RM   |                            |
|--------|--|-------------------------------------|---|--------------|--|------------|---|--|----------------------------|
| Series | Core Housing   | Function Code                       | Lever Style   | Trim Style   | Finish                                     | Door Hand  | Manf.   | Locking Type   | Options                    |
| EXZ    | 0 – Less Core Housing<br>7 – 7-pin housing; accepts all BEST cores | EV – With key**<br>NV – Without key | 14 – Curved w/ return<br>15 – Contour w/ angle return | KP - Key Pad | 626 690<br>626AM*<br><br>Satin*<br>606 613 | RHR<br>LHR | VD9** – Von Duprin 98/99 series<br>PH2 – Precision Hardware 2000 series<br>SA8 – Sargent 8000 Series*** | RM – Rim<br>MO – Mortise<br>RD – Surface and concealed vertical rods | SH* – Security head screws |

\*Indicates extra cost option; see below.

\*\*The EV function (key override) is not available on the Von Duprin Mortise type.

\*\*\*SA8 Only available with Rim Type device. SA8 does not work with EV function (Key Override).

| FUNCTION DESCRIPTION              | FUNCTION CODE | COMPLETE WITH COMBINATED CORE |         |          | LESS CORE |
|-----------------------------------|---------------|-------------------------------|---------|----------|-----------|
|                                   |               | PATENTED*                     | PREMIUM | STANDARD |           |
| <b>KEYPAD EZ EXIT TRIM LOCKS:</b> |               |                               |         |          |           |
| EXZ - Exit Trim - single keyed    | EV            | 1819.00                       | 1819.00 | 1807.00  | 1737.00   |
| EXZ - Exit Trim - non keyed       | NV            | N/A                           | N/A     | N/A      | 1676.00   |

\*Patented pricing shown is for CORMAX patented keying system. Add \$20.00 for BEST Preferred patented keying.

| EXTRA COST OPTIONS*              | OPTION CODE    | ADD-ON |
|----------------------------------|----------------|--------|
| Satin finishes (per lock)        | 606, 613, etc. | 59.00  |
| UltraShield antimicrobial finish | 626AM          | 127.00 |
| Security head screws             | SH             | 22.00  |



## 45HG Offline G Series Mortise Locks

### How To Order

| 45HG   | 7  | TV   | 14   | MS  | 626  | RH                     |  |
|--------|--|--|--|---|--|------------------------|--|
| Series | Core Housing   | Function Code  | Lever Style  | Trim Style  | Finish   | Door Hand              | Options  |
| 45HG   | 0** – Less Core Housing<br>7 – 7-pin housing; accepts all BEST cores | DV – Latch w/key<br>TV – Deadbolt w/key<br>LV – Deadbolt w/o key<br>NV – Latch w/o key | Levers:<br>3 – Solid tube/return<br>12* – Solid tube/no return<br>14 – Curved/return<br>15 – Contour/angle return<br>16 – Curved/no return<br>17* – Gull wing<br>Knobs:<br>4 – Round<br>Decorative*<br>50-91 | MS**** – Magnetic stripe<br>DV**** – Dual validation (magstripe and keypad)<br>DVA**** – Other cylinder<br>MSA**** – Other cylinder | 626 690<br>626AM*<br><br>Satin*<br>606 612<br>613 619<br><br>Bright*<br>605 611<br>625 | RH<br>RHR<br>LH<br>LHR | 8CE* – 8 cell battery holder assy with batteries<br>4SW – 4 cell shrink wrap battery<br>P2*** – Phillips head screws<br>KOS* – Key override sensor<br>Thick Door* – Specify thickness<br>7/8** – Flat lip strike<br>TAC/I* – Tactile Lever Inside<br>TAC/O* – Tactile lever Outside<br>TAC/B* – Tactile Lever Both<br>TRK1**** – Track 1<br>TRK2**** – Track 2<br>TRK3**** – Track 3<br>WS – Windstorm Label (NOA Miami-Dade County) |

\*Indicates extra cost option.

\*\*Indicates cost deduction.

\*\*\*T15 Torx security screws are supplied standard.

\*\*\*\*Must specify track number.

| FUNCTION DESCRIPTION                             | FUNCTION CODE | COMPLETE WITH COMBINED CORE |         |          | LESS CORE |
|--|---------------|-----------------------------|---------|----------|-----------|
|  |               | PATENTED*                   | PREMIUM | STANDARD |           |
| <b>MAGNETIC STRIPE READER:</b>                   |               |                             |         |          |           |
| 45HG - Single Keyed Latch                        | DV            | 1609.00                     | 1609.00 | 1597.00  | 1527.00   |
| 45HG - Single Keyed Deadbolt                     | TV            | 1639.00                     | 1639.00 | 1627.00  | 1557.00   |
| 45HG - Non-keyed Latch                           | NV            | N/A                         | N/A     | N/A      | 1466.00   |
| 45HG - Non-keyed Deadbolt                        | LV            | N/A                         | N/A     | N/A      | 1496.00   |
| <b>MAG STRIPE/KEYPAD DUAL VALIDATION READER:</b> |               |                             |         |          |           |
| 45HG - Single Keyed Latch                        | DV            | 1806.00                     | 1806.00 | 1794.00  | 1724.00   |
| 45HG - Single Keyed Deadbolt                     | TV            | 1841.00                     | 1841.00 | 1829.00  | 1759.00   |
| 45HG - Non-keyed Latch                           | NV            | N/A                         | N/A     | N/A      | 1663.00   |
| 45HG - Non-keyed Deadbolt                        | LV            | N/A                         | N/A     | N/A      | 1698.00   |

\*Patented pricing shown is for CORMAX patented keying system. Add \$20.00 for BEST Preferred patented keying.

| EXTRA COST OPTIONS*              | OPTION CODE             | ADD-ON |
|----------------------------------|-------------------------|--------|
| Satin finishes (per lock)        | 606, 612, 613, 619 etc. | 59.00  |
| Bright finishes (per lock)       | 605, 611, 625, etc.     | 115.00 |
| UltraShield antimicrobial finish | 626AM                   | 127.00 |
| Thick door                       | Specify thickness       | 85.00  |
| Tactile both levers/knobs**      | TAC/B                   | 120.00 |
| Tactile outside lever/knob**     | TAC/O                   | 61.00  |
| Tactile inside lever/knob**      | TAC/I                   | 61.00  |
| 7/8" Lip-to-center strike        | 7/8 LTC                 | 22.00  |
| 12, 17 Lever Design              | 12, 17                  | 66.00  |
| Decorative Lever Design          | 50-91                   | 211.00 |
| Extended Life Battery            | 8CE                     | 68.00  |
| Key Override Sensor              | KOS                     | 36.00  |

\*\*Not available on #17 levers.

| **COST DEDUCTIONS                                 | OPTION CODE | DEDUCT |
|---|-------------|--------|
| Less cylinder option (Deduct from complete price) | 0           | 61.00  |





## 9KG Offline G Series Cylindrical Locks

### How To Order

| 9KG    | 3                                    | 7   | DV            | 14  | MS  | STK   | 626  |  |
|--------|--------------------------------------|---|---------------|---|---|---|--|--|
| Series | Backset                              | Core Housing  | Function Code | Lever Style   | Rose Style  | Strike Package  | Finish   | Options  |
| 9KG    | 3 – 2-3/4"<br>4* – 3-3/4"<br>5* – 5" | 0*** – Non-IC and LFIC competitive cylinder (less core)<br>6** – 6 pin non-IC cylinder<br>7 – 7-pin housing; accepts all BEST cores | DV – with key | 4 – Round knob<br>14 – Curved with return<br>15 – Contour with angle return<br>16 – Curved without return | MS***** – Magnetic stripe<br>DV***** – Dual validation (magstripe and keypad) | STK - Standard<br>S3 - ANSI<br>S3 - 7/8" Lip to Center Strike<br>S3B* - ANSI (Strike w/ Plastic Box)<br>S3B 7/8* - ANSI (Strike w/ Plastic Box) | 626 690<br>626AM*<br><br>Satin*<br>606 612<br><br>Bright*<br>605 625 | 8CE* – 8 cell battery holder assy with batteries<br>4SW – 4 cell shrink wrap battery<br>P2**** – Phillips head screws<br>FM – Free Motion<br>3/4* – 3/4" throw latch<br>0B** – non-IC zero-bitted<br>KA** – non-IC keyed alike<br>KD** – non-IC keyed different<br>COR*** – Non IC Corbin-Russwin<br>MED*** – Non IC Medeco<br>SAR*** – Non IC Sargent<br>SCH*** – Non IC Schlage<br>YAL*** – Non IC Yale<br>SARRC*** – LFIC Sargent<br>CORRC*** – LFIC Corbin<br>YALRC*** – LFIC Yale<br>SCHRC*** – LFIC Schlage<br>AL/O* – Abrasive Lever Outside<br>AL/I* – Abrasive Lever Inside<br>AL/B* – Abrasive Lever Both<br>TL/O* – Tactile Lever Outside<br>TL/I* – Tactile Lever Inside<br>TL/B* – Tactile Lever Both<br>FRL – Full Radius Latch<br>TRK1***** – Track 1<br>TRK2***** – Track 2<br>TRK3***** – Track 3<br>WS – Windstorm Label (NOA Miami-Dade County) |

\* Indicates extra cost option.  
 \*\* Six-pin cylinder in Schlage "C" keyway included with 0B, KA, KD options. Must specify "6" for core housing.  
 \*\*\* Cylinder not included with COR, MED, SAR, SCH, YAL, CORRC, YALRC, SARRC, or SCHRC options. Must specify "0" for core housing.  
 \*\*\*\* T15 Torx security screws are supplied standard.  
 \*\*\*\*\* Must specify track number.

| FUNCTION DESCRIPTION                             | FUNCTION CODE | COMPLETE WITH COMBINATED CORE |         |          | LESS CORE | NON-IC CYLINDER 0B, KA, KD |
|--|---------------|-------------------------------|---------|----------|-----------|----------------------------|
|  |               | PATENTED*                     | PREMIUM | STANDARD |           |                            |
| <b>MAGNETIC STRIPE READER:</b>                   |               |                               |         |          |           |                            |
| 9KG - Single keyed lock                          | DV            | 1466.00                       | 1466.00 | 1454.00  | 1384.00   | 1435.00                    |
| <b>MAG STRIPE/KEYPAD DUAL VALIDATION READER:</b> |               |                               |         |          |           |                            |
| 9KG - Single keyed lock                          | DV            | 1674.00                       | 1674.00 | 1662.00  | 1592.00   | 1643.00                    |

| EXTRA COST OPTIONS*              | OPTION CODE         | ADD-ON |
|----------------------------------|---------------------|--------|
| Satin finishes (per lock)        | 606, 612, 613, etc. | 59.00  |
| Bright finishes (per lock)       | 605, 625, 629, etc. | 115.00 |
| UltraShield antimicrobial finish | 626AM               | 127.00 |
| 3/4" throw latch                 | 3/4                 | 31.00  |
| Special backsets                 | 94KG / 95KG         | 21.00  |
| Abrasive lever both sides        | AL/B                | 43.00  |
| Abrasive lever outside           | AL/O                | 22.00  |
| Abrasive lever inside            | AL/I                | 22.00  |
| Tactile lever both sides         | TL/B                | 84.00  |
| Tactile lever outside            | TL/O                | 43.00  |
| Tactile lever inside             | TL/I                | 43.00  |
| 7/8" Lip-to-center strike        | S3 7/8              | 22.00  |
| Strike with plastic box          | S3B or S3B 7/8      | 2.20   |
| Extended Life Battery            | 8CE                 | 68.00  |
| Full radius latch                | FRL                 | 21.00  |

\* Patented pricing shown is for CORMAX patented keying system. Add \$20.00 for BEST Preferred patented keying.

| PART DESCRIPTION         | PART NUMBER | PART PRICE |
|--------------------------|-------------|------------|
| 2-3/4" deadlocking latch | 8KL3        | 79.00      |
| 3-3/4" deadlocking latch | 8KL4        | 100.00     |
| 5" deadlocking latch     | 8KL5        | 100.00     |
| Standard strike package  | 8KS2        | 7.80       |
| ANSI strike package      | 8KS3        | 24.00      |
| Throw member 7-pin       | B54200      | 1.80       |



## EXG Offline G Series Exit Trim

### How To Order

| EXG    | 7  | EV                                  | 15  | MS  | 626  | RHR        | PH2   | RM  |  |
|--------|--|-------------------------------------|---|---|--|------------|---|---|--|
| Series | Core Housing   | Function Code                       | Lever Style   | Trim Style  | Finish                                     | Door Hand  | Manf.   | Locking Type  | Options  |
| EXG    | 0 – Less Core Housing<br>7 – 7-pin housing; accepts all BEST cores | EV – With key**<br>NV – Without key | 14 – Curved w/ return<br>15 – Contour w/ angle return | MS**** – Magnetic stripe<br>DV**** – Dual validation (magstripe and keypad) | 626 690<br>626AM*<br><br>Satin*<br>606 613 | RHR<br>LHR | VD9** – Von Duprin 98/99 series<br>PH2 – Precision Hardware 2000 series<br>SA8 – Sargent 8000 Series*** | RM – Rim***<br>MO – Mortise<br>RD – Surface and concealed vertical rods | SH* – Security head screws<br>TRK1**** – Track 1<br>TRK2**** – Track 2<br>TRK3**** – Track 3 |

\*Indicates extra cost option; see below.

\*\*The EV function (key override) is not available on the Von Duprin Mortise type.

\*\*\*SA8 Only available with Rim Type device. SA8 does not work with EV function (Key Override).

\*\*\*\*Must specify track number.

| FUNCTION DESCRIPTION                             | FUNCTION CODE | COMPLETE WITH CORE |         |          | LESS CORE LIST PRICE |
|--|---------------|--------------------|---------|----------|----------------------|
|  |               | PATENTED*          | PREMIUM | STANDARD |                      |
| <b>MAGNETIC STRIPE READER:</b>                   |               |                    |         |          |                      |
| EXG - Exit Trim - single keyed                   | EV            | 1961.00            | 1961.00 | 1949.00  | 1879.00              |
| EXG - Exit Trim - non keyed                      | NV            | N/A                | N/A     | N/A      | 1818.00              |
| <b>MAG STRIPE/KEYPAD DUAL VALIDATION READER:</b> |               |                    |         |          |                      |
| EXG - Exit Trim - single keyed                   | EV            | 2168.00            | 2168.00 | 2156.00  | 2086.00              |
| EXG - Exit Trim - non keyed                      | NV            | N/A                | N/A     | N/A      | 2025.00              |

| EXTRA COST OPTIONS*              | OPTION CODE    | ADD-ON |
|----------------------------------|----------------|--------|
| Satin finishes (per lock)        | 606, 613, etc. | 59.00  |
| UltraShield antimicrobial finish | 626AM          | 127.00 |
| Security head screws             | SH             | 22.00  |

\*Patented pricing shown is for CORMAX patented keying system. Add \$20.00 for BEST Preferred patented keying.



## 45HBV Offline V Series Mortise Locks

### How To Order

| 45HBV  | 7  | TV   | 14   | MS  | 626   | RH                     |  |
|--------|--|--|--|---|---|------------------------|--|
| Series | Core Housing   | Function Code  | Lever Style  | Trim Style  | Finish  | Door Hand              | Options  |
| 45HBV  | 0** – Less Core Housing<br>7 – 7-pin housing; accepts all BEST cores | DV – Latch w/key<br>TV – Deadbolt w/key<br>LV – Deadbolt w/o key<br>NV – Latch w/o key | Levers:<br>3 – Solid tube/return<br>12* – Solid tube/no return<br>14 – Curved/return<br>15 – Contour/angle return<br>16 – Curved/no return<br>17* – Gull wing<br>Knobs:<br>4 – Round<br>Decorative*<br>50-91 | MS**** – Magnetic stripe<br>DV**** – Dual validation (magstripe and keypad)<br>PH – Proximity HID®<br>PKP – Proximity + Keypad<br>SE – HID® iClass® Smart Card<br>DVA**** – Dual Validation Adaptation<br>MSA**** – Magstripe<br>Adaptation<br>PHA – Prox HID® Adaptation<br>PKPA – Proximity + Keypad Adaptation<br>SEA – HID® iClass® Smart Card Adaptation | 626 630<br>690<br>626AM*<br>630AM*<br>Satin*<br>606 612<br>613 619<br>Bright*<br>605 611<br>625 629 | RH<br>RHR<br>LH<br>LHR | 8CE* – 8 cell battery holder assy with batteries<br>4SW – 4 cell shrink wrap battery<br>P2*** – Phillips head screws<br>KOS* – Key override sensor<br>Thick Door* – Specify thickness<br>7/8"* – Flat lip strike<br>TAC/I* – Tactile Lever Inside<br>TAC/O* – Tactile lever Outside<br>TAC/B* – Tactile Lever Both<br>TRK1**** – Track 1<br>TRK2**** – Track 2<br>TRK3**** – Track 3<br>MWIE – Motorola 26 bit Wiegand<br>H26B – HID 26 bit Wiegand<br>H37B – HID 37 bit Wiegand<br>WS – Windstorm Label (NOA Miami-Dade County) |

\*Indicates extra cost option.

\*\*Indicates cost deduction.

\*\*\*T15 Torx security screws are supplied standard.

\*\*\*\*Must specify track number.

| FUNCTION DESCRIPTION                             | FUNCTION CODE | COMPLETE WITH COMBINED CORE |         |          | LESS CORE |
|--|---------------|-----------------------------|---------|----------|-----------|
|  |               | PATENTED*                   | PREMIUM | STANDARD |           |
| <b>MAGNETIC STRIPE READER:</b>                   |               |                             |         |          |           |
| 45HBV - Single Keyed Latch                       | DV            | 1859.00                     | 1859.00 | 1847.00  | 1777.00   |
| 45HBV - Single Keyed Deadbolt                    | TV            | 1877.00                     | 1877.00 | 1865.00  | 1795.00   |
| 45HBV - Non-keyed Latch                          | NV            | N/A                         | N/A     | N/A      | 1716.00   |
| 45HBV - Non-keyed Deadbolt                       | LV            | N/A                         | N/A     | N/A      | 1734.00   |
| <b>MAG STRIPE/KEYPAD DUAL VALIDATION READER:</b> |               |                             |         |          |           |
| 45HBV - Single Keyed Latch                       | DV            | 2054.00                     | 2054.00 | 2042.00  | 1972.00   |
| 45HBV - Single Keyed Deadbolt                    | TV            | 2056.00                     | 2056.00 | 2044.00  | 1974.00   |
| 45HBV - Non-keyed Latch                          | NV            | N/A                         | N/A     | N/A      | 1911.00   |
| 45HBV - Non-keyed Deadbolt                       | LV            | N/A                         | N/A     | N/A      | 1913.00   |
| <b>HID PROXIMITY READER:</b>                     |               |                             |         |          |           |
| 45HBV - Single Keyed Latch                       | DV            | 2499.00                     | 2499.00 | 2487.00  | 2417.00   |
| 45HBV - Single Keyed Deadbolt                    | TV            | 2522.00                     | 2522.00 | 2510.00  | 2440.00   |
| 45HBV - Non-keyed Latch                          | NV            | N/A                         | N/A     | N/A      | 2356.00   |
| 45HBV - Non-keyed Deadbolt                       | LV            | N/A                         | N/A     | N/A      | 2379.00   |
| <b>PKP – PROXIMITY + KEYPAD READER:</b>          |               |                             |         |          |           |
| 45HBV - Single Keyed Latch                       | DV            | 2309.00                     | 2309.00 | 2297.00  | 2227.00   |
| 45HBV - Single Keyed Deadbolt                    | TV            | 2327.00                     | 2327.00 | 2315.00  | 2245.00   |
| 45HBV - Non-keyed Latch                          | NV            | N/A                         | N/A     | N/A      | 2162.00   |
| 45HBV - Non-keyed Deadbolt                       | LV            | N/A                         | N/A     | N/A      | 2180.00   |
| <b>SE – HID® ICLASS® SMART CARD READER:</b>      |               |                             |         |          |           |
| 45HBV - Single Keyed Latch                       | DV            | 2454.00                     | 2454.00 | 2442.00  | 2372.00   |
| 45HBV - Single Keyed Deadbolt                    | TV            | 2456.00                     | 2456.00 | 2444.00  | 2374.00   |
| 45HBV - Non-keyed Latch                          | NV            | N/A                         | N/A     | N/A      | 2307.00   |
| 45HBV - Non-keyed Deadbolt                       | LV            | N/A                         | N/A     | N/A      | 2309.00   |

\*Patented pricing shown is for CORMAX patented keying system. Add \$20.00 for BEST Preferred patented keying.



## 45HBV Offline V Series Mortise Locks (continued)

| EXTRA COST OPTIONS*              | OPTION CODE             | ADD-ON |
|----------------------------------|-------------------------|--------|
| Satin finishes (per lock)        | 606, 612, 613, 619 etc. | 59.00  |
| Bright finishes (per lock)       | 605, 611, 625, etc.     | 115.00 |
| UltraShield antimicrobial finish | 626AM, 630AM            | 127.00 |
| Thick door                       | Specify thickness       | 85.00  |
| Tactile both levers/knobs**      | TAC/B                   | 120.00 |
| Tactile outside lever/knob**     | TAC/O                   | 61.00  |
| Tactile inside lever/knob**      | TAC/I                   | 61.00  |
| Security head screws             | SH                      | 22.00  |
| 7/8" Lip-to-center strike        | 7/8 LTC                 | 22.00  |
| 12, 17 Lever Design              | 12, 17                  | 66.00  |
| Decorative Lever Design          | 50-91                   | 211.00 |
| Extended Life Battery            | 8CE                     | 68.00  |
| Key Override Sensor              | KOS                     | 36.00  |

\*\*Not available on #17 levers.

| **COST DEDUCTIONS                                 | OPTION CODE | DEDUCT |
|---|-------------|--------|
| Less cylinder option (Deduct from complete price) | 0           | 61.00  |

\*Patented pricing shown is for CORMAX patented keying system. Add \$20.00 for BEST Preferred patented keying.

## 9KBV Offline V Series Cylindrical Locks

### How To Order

| 9KBV   | 3                                    | 7   | DV            | 14  | MS   | STK   | 626  |  |
|--------|--------------------------------------|---|---------------|---|--|---|--|--|
| Series | Backset                              | Core Housing  | Function Code | Lever Style   | Rose Style   | Strike Package  | Finish   | Options  |
| 9KBV   | 3 – 2-3/4"<br>4* – 3-3/4"<br>5* – 5" | 0*** – Non-IC and LFIC competitive cylinder (less core)<br>6** – 6 pin non-IC cylinder<br>7 – 7-pin housing; accepts all BEST cores | DV – with key | 4 – Round knob<br>14 – Curved with return<br>15 – Contour with angle return<br>16 – Curved without return | MS***** – Magnetic stripe<br>DV***** – Dual validation (magstripe and keypad)<br>PH – Proximity HID®<br>PKP – Proximity + Keypad<br>SE – HID® iClass® Smart Card | STK – Standard<br>S3 – ANSI<br>S3 7/8* – Lip to center strike<br>S3B* - ANSI (Strike w/ Plastic Box)<br>S3B 7/8* - ANSI (Strike w/ Plastic Box) | 626 690<br>626AM*<br><br>Satin*<br>606 612<br><br>Bright*<br>605 625 | 8CE* – 8 cell battery holder assy with batteries<br>4SW – 4 cell shrink wrap battery<br>P2**** – Phillips head screws<br>FM – Free Motion<br>3/4* – 3/4" throw latch<br>OB** – non-IC zero-bitted<br>KA** – non-IC keyed alike<br>KD** – non-IC keyed different<br>COR*** – Non IC Corbin-Russwin<br>MED*** – Non IC Medeco<br>SAR*** – Non IC Sargent<br>SCH*** – Non IC Schlage<br>YAL*** – Non IC Yale<br>SARRC*** – LFIC Sargent<br>CORRC*** – LFIC Corbin<br>YALRC*** – LFIC Yale<br>SCHRC*** – LFIC Schlage<br>AL/O* – Abrasive Lever Outside<br>AL/I* – Abrasive Lever Inside<br>AL/B* – Abrasive Lever Both<br>TL/O* – Tactile Lever Outside<br>TL/I* – Tactile Lever Inside<br>TL/B* – Tactile Lever Both<br>FRL – Full Radius Latch<br>TRK1***** – Track 1<br>TRK2***** – Track 2<br>TRK3***** – Track 3<br>MWIE – Motorola 26 bit Wiegand<br>H26B – HID 26 bit Wiegand<br>H37B – HID 37 bit Wiegand<br>WS – Windstorm Label (NOA Miami-Dade County) |

\* Indicates extra cost option.

\*\* Six-pin cylinder in Schlage "C" keyway included with OB, KA, KD options. Must specify "6" for core housing.

\*\*\* Cylinder not included with COR, MED, SAR, SCH, YAL, CORRC, YALRC, SARRC, or SCHRC options. Must specify "0" for core housing.

\*\*\*\*T15 Torx security screws are supplied standard.

\*\*\*\*\* Must specify track number.



## 9KBV Offline V Series Cylindrical Locks (continued)

| DESCRIPTION                                      | FUNCTION CODE | COMPLETE WITH COMBINATED CORE |         |          | LESS CORE | NON-IC CYLINDER<br>0B, KA, KD |
|--|---------------|-------------------------------|---------|----------|-----------|-------------------------------|
|  |               | PATENTED*                     | PREMIUM | STANDARD |           |                               |
| <b>MAGNETIC STRIPE READER:</b>                   |               |                               |         |          |           |                               |
| 9KBV - Single keyed lock                         | DV            | 1691.00                       | 1691.00 | 1679.00  | 1609.00   | 1660.00                       |
| <b>MAG STRIPE/KEYPAD DUAL VALIDATION READER:</b> |               |                               |         |          |           |                               |
| 9KBV - Single keyed lock                         | DV            | 1887.00                       | 1887.00 | 1875.00  | 1805.00   | 1856.00                       |
| <b>HID PROXIMITY READER:</b>                     |               |                               |         |          |           |                               |
| 9KBV - Single keyed lock                         | DV            | 2337.00                       | 2337.00 | 2325.00  | 2255.00   | 2306.00                       |
| <b>PKP – PROXIMITY + KEYPAD READER:</b>          |               |                               |         |          |           |                               |
| 9KBV - Single keyed lock                         | DV            | 2141.00                       | 2141.00 | 2129.00  | 2059.00   | 2110.00                       |
| <b>SE – HID® ICLASS® SMART CARD READER:</b>      |               |                               |         |          |           |                               |
| 9KBV - Single keyed lock                         | DV            | 2091.00                       | 2091.00 | 2079.00  | 2009.00   | 2060.00                       |

| EXTRA COST OPTIONS*              | OPTION CODE         | ADD-ON |
|----------------------------------|---------------------|--------|
| Satin finishes (per lock)        | 606, 612, 613, etc. | 59.00  |
| Bright finishes (per lock)       | 605, 625, 629, etc. | 115.00 |
| UltraShield antimicrobial finish | 626AM               | 127.00 |
| 3/4" throw latch                 | 3/4                 | 31.00  |
| Special backsets                 | 94KBV / 95KBV       | 21.00  |
| Abrasive lever both sides        | AL/B                | 43.00  |
| Abrasive lever outside           | AL/O                | 22.00  |
| Abrasive lever inside            | AL/I                | 22.00  |
| Tactile lever both sides         | TL/B                | 84.00  |
| Tactile lever outside            | TL/O                | 43.00  |
| Tactile lever inside             | TL/I                | 43.00  |
| 7/8" Lip-to-center strike        | S3 7/8              | 22.00  |
| Strike with plastic box          | S3B or S3B 7/8      | 2.20   |
| Extended Life Battery            | 8CE                 | 68.00  |
| Full radius latch                | FRL                 | 21.00  |

\*Patented pricing shown is for CORMAX patented keying system. Add \$20.00 for BEST Preferred patented keying.

| PART DESCRIPTION           | PART NUMBER       | PART PRICE |
|----------------------------|-------------------|------------|
| 2-3/4" deadlocking latch   | 8KL3              | 79.00      |
| 3-3/4" deadlocking latch   | 8KL4              | 100.00     |
| 5" deadlocking latch       | 8KL5              | 100.00     |
| Standard strike package    | 8KS2              | 7.80       |
| ANSI strike package        | 8KS3              | 24.00      |
| Throw member 6-pin / 7-pin | 71217417 / B54200 | 1.80       |



## EXBV Offline V Series Exit Trim

### How To Order

| EXBV   | 7  | EV                                  | 15  | MS   | 626  | RHR        | PH2   | RM   |  |
|--------|--|-------------------------------------|---|--|--|------------|---|--|--|
| Series | Core Housing   | Function Code                       | Lever Style   | Trim Style   | Finish                                     | Door Hand  | Manf.   | Locking Type   | Options  |
| EXBV   | 0 – Less Core Housing<br>7 – 7-pin housing; accepts all BEST cores | EV – With key**<br>NV – Without key | 14 – Curved w/ return<br>15 – Contour w/ angle return | MS**** – Magnetic stripe<br>DV**** – Dual validation (magstripe and keypad)<br>PH – Proximity HID®<br>PKP – Proximity + Keypad<br>SE – HID® iClass® Smart Card | 626 690<br>626AM*<br><br>Satin*<br>606 613 | RHR<br>LHR | PH2 – Precision Hardware 2000 series<br>VD9** – Von Duprin 98/99 series<br>SA8 – Sargent 8000 Series*** | RM – Rim<br>MO – Mortise<br>RD – Surface and concealed vertical rods | SH* – Security head screws<br>TRK1**** – Track 1<br>TRK2**** – Track 2<br>TRK3**** – Track 3<br>MWIE – Motorola 26 bit Wiegand<br>H26B – HID 26 bit Wiegand<br>H37B – HID 37 bit Wiegand |

\*Indicates extra cost option; see below.

\*\*The EV function (key override) is not available on the Von Duprin Mortise type.

\*\*\*SA8 Only available with Rim Type device. SA8 does not work with EV function (Key Override).

\*\*\*\*Must specify track number.

| DESCRIPTION                                      | FUNCTION CODE | COMPLETE WITH COMBINATED CORE |         |          | LESS CORE |
|--|---------------|-------------------------------|---------|----------|-----------|
|  |               | PATENTED*                     | PREMIUM | STANDARD |           |
| <b>MAGNETIC STRIPE READER:</b>                   |               |                               |         |          |           |
| EXBV - Exit Trim - single keyed                  | EV            | 2026.00                       | 2026.00 | 2015.00  | 1948.00   |
| EXBV - Exit Trim - non keyed                     | NV            | N/A                           | N/A     | N/A      | 1887.00   |
| <b>MAG STRIPE/KEYPAD DUAL VALIDATION READER:</b> |               |                               |         |          |           |
| EXBV - Exit Trim - single keyed                  | EV            | 2223.00                       | 2223.00 | 2212.00  | 2145.00   |
| EXBV - Exit Trim - non keyed                     | NV            | N/A                           | N/A     | N/A      | 2084.00   |
| <b>HID PROXIMITY READER:</b>                     |               |                               |         |          |           |
| EXBV - Exit Trim - single keyed                  | EV            | 2669.00                       | 2669.00 | 2658.00  | 2591.00   |
| EXBV - Exit Trim - non keyed                     | NV            | N/A                           | N/A     | N/A      | 2530.00   |
| <b>PKP – PROXIMITY + KEYPAD READER:</b>          |               |                               |         |          |           |
| EXBV - Exit Trim - single keyed                  | EV            | 2553.00                       | 2553.00 | 2541.00  | 2471.00   |
| EXBV - Exit Trim - non keyed                     | NV            | N/A                           | N/A     | N/A      | 2406.00   |
| <b>SE – HID® ICLASS® SMART CARD READER:</b>      |               |                               |         |          |           |
| EXBV - Exit Trim - single keyed                  | EV            | 2503.00                       | 2503.00 | 2491.00  | 2421.00   |
| EXBV - Exit Trim - non keyed                     | NV            | N/A                           | N/A     | N/A      | 2356.00   |

\*Patented pricing shown is for CORMAX patented keying system. Add \$20.00 for BEST Preferred patented keying.

| EXTRA COST OPTIONS*              | OPTION CODE    | ADD-ON |
|----------------------------------|----------------|--------|
| Satin finishes (per lock)        | 606, 613, etc. | 59.00  |
| UltraShield antimicrobial finish | 626AM          | 127.00 |
| Security head screws             | SH             | 22.00  |



## 45HM IDH MAX™ Mortise Locks

### How To Order

| 45HM   | 7  | DEU  | 14   | MS   | 626   | RH                       |   |
|--------|--|--|--|--|---|--------------------------|---|
| Series | Core Housing   | Function Code  | Lever Style  | Trim Style   | Finish  | Door Hand                | Options   |
| 45HM   | 0** – Less Core Housing<br>7 – 7-pin housing; accepts all BEST cores | DEU – Electrically unlocked<br>DEL – Electrically locked<br>NXEU – Electrically unlocked<br>NXEL – Electrically Locked<br>TDEU – Electrically Unlocked<br>TDEL – Electrically Locked<br>LEU – Electrically unlocked<br>LEL – Electrically locked | Levers:<br>3 – Solid tube/return<br>4 – Round<br>12* – Solid tube/no return<br>14 – Curved/return<br>15 – Contour/angle return<br>16 – Curved/no return<br>17* – Gull wing<br><br>Decorative*<br>50-91 | MS**** – Magnetic stripe<br>PH – Proximity HID®<br>SE – HID® iClass® Smart Card<br>MSA**** – Magstripe Adaptation<br>PHA – Proximity HID Adaptation<br>SE – HID® iClass® Smart Card Adaptation | 626 630<br>690<br>626AM*<br>630AM*<br>Satin*<br>606 612<br>613<br>Bright*<br>605 611<br>625 629 | RH<br>RHRB<br>LH<br>LHRB | P2*** – Phillips head screws<br>Thick Door* – Specify thickness<br>7/8*** – Flat lip strike<br>1300* – Mercury Direct Connect<br>TAC/1* – Tactile Lever Inside<br>TAC/O* – Tactile lever Outside<br>TAC/B* – Tactile Lever Both<br>MWIE – Motorola 26 bit Wiegand<br>H26B – HID 26 bit Wiegand<br>H37B – HID 37 bit Wiegand<br>TRK2**** - Track 2<br>TRK3**** - Track 3 |

\* Indicates extra cost; see below.

\*\* Indicates cost deduction; see below.

\*\*\*T15 Torx security screws are supplied standard.

\*\*\*\*Must specify track number.

| DESCRIPTION                                 | FUNCTION CODE | COMPLETE WITH COMBINED CORE |         |          | LESS CORE |
|---|---------------|-----------------------------|---------|----------|-----------|
|   |               | PATENTED*                   | PREMIUM | STANDARD |           |
| <b>MAGNETIC STRIPE READER:</b>              |               |                             |         |          |           |
| 45HM - Single Keyed Latch                   | DEU, DEL      | 2312.00                     | 2312.00 | 2300.00  | 2230.00   |
| 45HM - Non-keyed Latch                      | NXEU, NXEL    | N/A                         | N/A     | N/A      | 2169.00   |
| 45HM - Single Keyed Deadbolt                | TDEU, TDEL    | 2335.00                     | 2335.00 | 2323.00  | 2253.00   |
| 45HM - Non-keyed Deadbolt                   | LEU, LEL      | N/A                         | N/A     | N/A      | 2192.00   |
| <b>HID PROXIMITY READER:</b>                |               |                             |         |          |           |
| 45HM - Single Keyed Latch                   | DEU, DEL      | 2979.00                     | 2979.00 | 2967.00  | 2897.00   |
| 45HM - Non-keyed Latch                      | NXEU, NXEL    | N/A                         | N/A     | N/A      | 2836.00   |
| 45HM - Single Keyed Deadbolt                | TDEU, TDEL    | 2984.00                     | 2984.00 | 2972.00  | 2902.00   |
| 45HM - Non-keyed Deadbolt                   | LEU, LEL      | N/A                         | N/A     | N/A      | 2841.00   |
| <b>SE – HID® ICLASS® SMART CARD READER:</b> |               |                             |         |          |           |
| 45HM - Single keyed latch                   | DEU, DEL      | 2712.00                     | 2712.00 | 2700.00  | 2630.00   |
| 45HM - Non-Keyed Latch                      | NXEU, NXEL    | N/A                         | N/A     | N/A      | 2565.00   |
| 45HM - Single Keyed Deadbolt                | TDEU, TDEL    | 2735.00                     | 2735.00 | 2723.00  | 2653.00   |
| 45HM - Non-keyed Deadbolt                   | LEU, LEL      | N/A                         | N/A     | N/A      | 2588.00   |

\*Patented pricing shown is for CORMAX patented keying system. Add \$20.00 for BEST Preferred patented keying.



## 45HM IDH MAX™ Mortise Locks (continued)

| EXTRA COST OPTIONS*                              | OPTION CODE             | ADD-ON |
|--|-------------------------|--------|
| Satin finishes (per lock)                        | 606, 612, 613, 619 etc. | 59.00  |
| Bright finishes (per lock)                       | 605, 611, 625, etc.     | 115.00 |
| UltraShield antimicrobial finish                 | 626AM, 630AM            | 127.00 |
| Thick door                                       | Specify thickness       | 85.00  |
| Tactile both levers/knobs**                      | TAC/B                   | 120.00 |
| Tactile outside lever/knob**                     | TAC/O                   | 61.00  |
| Tactile inside lever/knob**                      | TAC/I                   | 61.00  |
| 7/8" Lip-to-center strike                        | 7/8 LTC                 | 22.00  |
| 12, 17 Lever Design                              | 12, 17                  | 66.00  |
| Decorative Lever Design                          | 50-91                   | 211.00 |
| Integrated Mercury Single Reader Interface board | 1300                    | 642.00 |

\*\*Not available on #17 levers.

1300 Option - Integrated reader electronics board embedded behind the escutcheon, secured and out of sight. This option functions with B.A.S.I.S. / LENEL On Guard on-line equipment only.

| ** COST DEDUCTIONS                                | OPTION CODE | DEDUCT |
|---|-------------|--------|
| Less cylinder option (Deduct from complete price) | 0           | 61 .00 |





# 9KM IDH MAX™ Cylindrical Locks

## How To Order

| 9KM  | 3                                    | 7   | DDEU   | 14  | MS   | STK   | 626   |  |
|--|--------------------------------------|---|--|---|--|---|---|--|
| Series   | Back-set                             | Core Housing  | Function Code  | Lever Style   | Rose Style   | Strike Package  | Finish  | Options  |
| 9KM  | 3 – 2-3/4"<br>4* – 3-3/4"<br>5* – 5" | 0*** – Non-IC and LFIC competitive cylinder (less core)<br>6** – 6 pin non-IC cylinder<br>7 – 7-pin housing; accepts all BEST cores | DDEU – Electrically unlocked<br>DDEL**** – Electrically locked | 14 – Curved with return<br>15 – Contour with angle return<br>16 – Curved without return | MS***** – Magnetic stripe<br>PH – Proximity<br>HID@<br>SE – HID® iClass®<br>Smart Card | STK – Standard<br>S3 – ANSI<br>S3 7/8* – Lip to center strike<br>LS – Less Strike<br>S3B* - ANSI (Stike w/ Plastic Box)<br>S3B 7/8* - ANSI (Stike w/ Plastic Box) | 626 690<br>626AM*<br>Satin*<br>606 612<br>613 619<br>622<br>Bright*<br>605 611<br>625 | LM – Lost motion<br>P2**** – Phillips head screws<br>3/4* – 3/4" throw latch<br>1300* – Mercury Direct Connect<br>COR*** – Non IC Corbin-Russwin<br>MED*** – Non IC Medeco<br>SAR*** – Non IC Sargent<br>SCH*** – Non IC Schlage<br>YAL*** – Non IC Yale<br>SARRC*** - LFIC Sargent<br>CORRC*** - LFIC Corbin<br>YALRC*** - LFIC Yale<br>SCHRC*** - LFIC Schlage<br>AL/O* – Abrasive Lever Outside<br>AL/I* – Abrasive Lever Inside<br>AL/B* – Abrasive Lever Both<br>TL/O* – Tactile Lever Outside<br>TL/I* – Tactile Lever Inside<br>TL/B* – Tactile Lever Both<br>FRL – Full Radius Latch<br>MWIE – Motorola 26 bit Wiegand<br>H26B – HID 26 bit Wiegand<br>H37B – HID 37 bit Wiegand<br>TRK2***** - Track 2<br>TRK3***** - Track 3<br>C-PRE† – Terminated Quick Connect Plug |
| <p>* Indicates extra cost option.<br/>           ** Six-pin cylinder in Schlage "C" keyway included with 0B, KA, KD options. Must specify "6" for core housing.<br/>           *** Cylinder not included with COR, MED, SAR, SCH, YAL, CORRC, YALRC, SARRC, or SCHRC options. Must specify "0" for core housing.<br/>           ****T15 Torx security screws are supplied standard.<br/>           *****DDEL is not available when using 1300 option.<br/>           *****Must specify track number.<br/>           †See Stanley Hinges &amp; Door Accessories price book for Wire Harness product</p> |                                      |   |  |   |  |   |   |  |

| FUNCTION DESCRIPTION                       | FUNCTION CODE | COMPLETE WITH COMBINATED CORE |         |          | LESS CORE | NON-IC CYLINDER 0B, KA, KD |
|--|---------------|-------------------------------|---------|----------|-----------|----------------------------|
|  |               | PATENTED*                     | PREMIUM | STANDARD |           |                            |
| <b>MAGNETIC STRIPE READER</b>              |               |                               |         |          |           |                            |
| 9KM - Single keyed lock                    | DDEU, DDEL    | 2208.00                       | 2208.00 | 2196.00  | 2126.00   | 2177.00                    |
| <b>HID PROXIMITY READER</b>                |               |                               |         |          |           |                            |
| 9KM - Single keyed lock                    | DDEU, DDEL    | 2869.00                       | 2869.00 | 2857.00  | 2787.00   | 2838.00                    |
| <b>SE – HID@ ICLASS@ SMART CARD READER</b> |               |                               |         |          |           |                            |
| 9KM - Single keyed latch                   | DDEU, DDEL    | 2608.00                       | 2608.00 | 2596.00  | 2526.00   | 2577.00                    |

\*Patented pricing shown is for CORMAX patented keying system. Add \$20.00 for BEST Preferred patented keying.

| EXTRA COST OPTIONS*                              | OPTION CODE         | ADD-ON |
|--|---------------------|--------|
| Satin finishes (per lock)                        | 606, 612, 613, etc. | 59.00  |
| Bright finishes (per lock)                       | 605, 625, 629, etc. | 115.00 |
| UltraShield antimicrobial finish                 | 626AM               | 127.00 |
| 3/4" throw latch                                 | 3/4                 | 31.00  |
| Special backsets                                 | 94KM / 95KM         | 21.00  |
| Abrasive lever both sides                        | AL/B                | 43.00  |
| Abrasive lever outside                           | AL/O                | 22.00  |
| Abrasive lever inside                            | AL/I                | 22.00  |
| Tactile lever both sides                         | TL/B                | 84.00  |
| Tactile lever outside                            | TL/O                | 43.00  |
| Tactile lever inside                             | TL/I                | 43.00  |
| 7/8" Lip-to-center strike                        | S3 7/8              | 22.00  |
| Strike with plastic box                          | S3B or S3B 7/8      | 2.20   |
| Integrated Mercury Single Reader Interface board | 1300                | 642.00 |
| Full radius latch                                | FRL                 | 21.00  |

1300 Option - Integrated reader electronics board embedded behind the escutcheon, secured and out of sight. This option functions with B.A.S.I.S. / LENEL On Guard on-line equipment only.

| PARTS                      | PART NUMBER       | PART PRICE |
|----------------------------|-------------------|------------|
| 2-3/4" deadlocking latch   | 8KL3              | 79.00      |
| 3-3/4" deadlocking latch   | 8KL4              | 100.00     |
| 5" deadlocking latch       | 8KL5              | 100.00     |
| Standard strike package    | 8KS2              | 7.80       |
| ANSI strike package        | 8KS3              | 24.00      |
| Throw member 6-pin / 7-pin | 71217417 / B54200 | 1.80       |



## Wi-Q™ Technology Wireless Access Management Software & Accessories

| DESCRIPTION                      | PART NUMBER | PRICE  |
|----------------------------------|-------------|--------|
| <b>Software</b>                  |             |        |
| Offline Series / Wi-Q™ Interface | WQS-BAS-INT | 243.00 |

| DESCRIPTION   | PART NUMBER | PRICE   |
|---|-------------|---------|
| <b>Portal Gateways (PG)</b>   |             |         |
| Portal Gateway for up to 64 Readers/Locks* with half wave dipole omnidirectional antenna (should only be used where PG is mounted in an open area, not in a ceiling or restricted signal area). | WQX-PG      | 1454.00 |
| Portal Gateway for up to 64 Readers/Locks* with ceiling mount omnidirectional antenna.  | WQX-PG-C    | 1694.00 |
| Portal Gateway with enclosure, power supply and ceiling mount omnidirectional antenna   | WQX-PG-C-B  | 2127.00 |
| Portal Gateway in a mounting enclosure, without Power Supply. This would be used with Power Over Ethernet (POE) devices (not included)  | WQX-PG-BP   | 1652.00 |
| Portal Gateway in a mounting enclosure, with ceiling mount omnidirectional antenna, without Power Supply. This would be used with Power Over Ethernet (POE) devices (not included)              | WQX-PG-C-BP | 1892.00 |
| Portal Gateway for up to 64 Readers/Locks* with wall mount directional antenna  | WQX-PG-W    | 1910.00 |
| Portal Gateway with enclosure, power supply and wall mount directional antenna  | WQX-PG-W-B  | 2342.00 |

\*Does not imply that 64 readers/locks will be within distance/RF range to connect. Total number of portal gateways required is based on individual system survey and requirements.

|  |               |         |
|--|---------------|---------|
| <b>Wireless Access Controllers (WAC)</b>   |               |         |
| Wireless Access Controller with half wave dipole omnidirectional antenna (should only be used where WAC is mounted in an open area, not in a ceiling or restricted signal area). | WQX-WAC       | 983.00  |
| Wireless Access Controller with ceiling mount omni directional antenn  | WQX-WAC-C     | 1226.00 |
| Wireless Access Controller in enclosure with power supply and ceiling mount omnidirectional antenna  | WQX-WAC-C-B   | 1658.00 |
| Wireless Access Controller with wall mount directional antenna   | WQX-WAC-W     | 1440.00 |
| Wireless Access Controller in enclosure with power supply and wall mount directional antenna   | WQX-WAC-W-B   | 1872.00 |
| Wireless Access Controller in Nema enclosure with power supply and exterior directional antenna  | WQX-WAC-D-BW  | 2308.00 |
| Wireless Access Controller in Nema enclosure with power supply and exterior omni-directional antenna   | WQX-WAC-O-BW  | 2219.00 |
| Wireless Access Controller sign-on keypad  | WQD-WACPAD    | 518.00  |
| Wireless Access Controller Survey Kit  | WQD-Survey    | 5790.00 |
| <b>Power and adapters</b>  |               |         |
| Sealed battery pack  | VPD-BB        | 41.00   |
| Plug-in Transformer (wall-mount) with 6' of cable  | WQD-12827     | 41.00   |
| Power over Ethernet Power Supply/Inserter  | WQD-12927-001 | 148.00  |
| Power over Ethernet Active Splitter with Isolation   | WQD-12928-001 | 143.00  |
| <b>Wi-Q™ Antennas &amp; Accessories</b>  |               |         |
| 2.4 GHz Interior Ceiling Mount Omni-directional Antenna kit*   | WQD-ACMO      | 311.00  |
| 2.4 GHz Interior/Exterior Wall mount directional antenna kit*  | WQD-AWMD      | 523.00  |
| 2.4GHZ Exterior directional antenna**  | WQD-AEMD      | 713.00  |
| 2.4GHZ Exterior omnidirectional mast mount kit**   | WQD-AEMO      | 565.00  |
| Exterior Antenna Grounding kit***  | WQD-AGT       | 423.00  |
| Surge Protection Kit   | WQD-SURG      | 318.00  |
| Cleaning Cards (box of 50)   | VPDCLN        | 195.00  |
| HID Proximity Card Enrollment Reader   | RDR6081AKU    | 987.00  |

\*Antenna Kit include antenna, standard mount and 20' cable to connect to PG or WAC.

\*\*Antenna Kit includes antenna, wall and post mounts and 20' cable to connect to PG or WAC.

\*\*\*Grounding Kit includes coax grounding kit and lightning arrester.



# BEST 45HQ Wireless Mortise Locks with Wi-Q™ Technology

## How To Order

| 45HQ   | 7  | TV                                      | 14   | MS   | 626   | RH                       |  |
|--------|--|---|--|--|---|--------------------------|--|
| Series | Core Housing   | Function Code                           | Lever Style  | Trim Style   | Finish  | Door Hand                | Options  |
| 45HQ   | 0** – Less Core Housing<br>7 – 7-pin housing; accepts all BEST cores | DV – Latch w/key<br>TV – Deadbolt w/key | Levers:<br>3 – Solid tube/return<br>12* – Solid tube/no return<br>14 – Curved/return<br>15 – Contour/angle return<br>16 – Curved/no return<br>17* – Gull wing<br>Knobs:<br>4 – Round<br><br>Decorative*<br>50-91 | MS**** – Magnetic stripe<br>DV**** – Dual validation (magstripe and keypad)<br>PH – Proximity HID®<br>PKP – Proximity + Keypad<br>SE – HID® iClass® Smart Card<br>DVA**** – Other cyl<br>MSA**** – Other cyl<br>PHA – Other cyl<br>PKPA – Proximity + Keypad – Other cyl<br>SEA – HID® iClass®<br>Smart Card – Other cyl | 626 630<br>690<br>626AM*<br>630AM*<br>Satin*<br>606 612<br>613<br>Bright*<br>605 611<br>625 629 | RH<br>RHRB<br>LH<br>LHRB | 8CE* – 8 cell battery holder assy with batteries<br>4SW – 4 cell shrink wrap battery<br>P2*** – Phillips head screws<br>Thick Door* – Specify thickness<br>7/8"* – Flat lip strike<br>TAC/I* – Tactile Lever Inside<br>TAC/O* – Tactile lever Outside<br>TAC/B* – Tactile Lever Both<br>TRK1**** – Track 1<br>TRK2**** – Track 2<br>TRK3**** – Track 3<br>WS – Windstorm Label (NOA Miami-Dade County) |

NOTE: Wireless locks come with Integrated Door Hardware (IDH) as standard -Request to Exit (RQE), door position switch (DS), latch bolt monitor switch (LS) and key-override switch (KOS) on DV Function.

\*Indicates extra cost option.

\*\*Indicates cost deduction.

\*\*\*T15 Torx security screws are supplied standard.

\*\*\*\*Must specify track number.

| FUNCTION DESCRIPTION                                 | FUNCTION CODE | COMPLETE WITH COMBINED CORE |         |          | LESS CORE |
|--|---------------|-----------------------------|---------|----------|-----------|
|  |               | PATENTED*                   | PREMIUM | STANDARD |           |
| <b>MAGNETIC STRIPE READER</b>                        |               |                             |         |          |           |
| 45HQ- Single Keyed Latch                             | DV            | 2202.00                     | 2202.00 | 2190.00  | 2120.00   |
| 45HQ- Single Keyed Deadbolt                          | TV            | 2224.00                     | 2224.00 | 2212.00  | 2142.00   |
| <b>MAGNETIC STRIPE/KEYPAD DUAL VALIDATION READER</b> |               |                             |         |          |           |
| 45HQ- Single Keyed Latch                             | DV            | 2427.00                     | 2427.00 | 2415.00  | 2345.00   |
| 45HQ- Single Keyed Deadbolt                          | TV            | 2450.00                     | 2450.00 | 2438.00  | 2368.00   |
| <b>HID® PROXIMITY READER</b>                         |               |                             |         |          |           |
| 45HQ- Single Keyed Latch                             | DV            | 2581.00                     | 2581.00 | 2569.00  | 2499.00   |
| 45HQ- Single Keyed Deadbolt                          | TV            | 2718.00                     | 2718.00 | 2706.00  | 2636.00   |
| <b>PKP – PROXIMITY + KEYPAD READER</b>               |               |                             |         |          |           |
| 45HQ- Single Keyed Latch                             | DV            | 2652.00                     | 2652.00 | 2640.00  | 2570.00   |
| 45HQ- Single Keyed Deadbolt                          | TV            | 2674.00                     | 2674.00 | 2662.00  | 2592.00   |
| <b>SE – HID® ICLASS® SMART CARD READER</b>           |               |                             |         |          |           |
| 45HQ- Single Keyed Latch                             | DV            | 2602.00                     | 2602.00 | 2590.00  | 2520.00   |
| 45HQ- Single Keyed Deadbolt                          | TV            | 2624.00                     | 2624.00 | 2612.00  | 2542.00   |

\*Patented pricing shown is for CORMAX patented keying system. Add \$20.00 for Best Preferred patented keying.



**BEST 45HQ Wireless Mortise Locks with Wi-Q™ Technology (continued)**

| <b>EXTRA COST OPTIONS*</b>       | <b>OPTION CODE</b> | <b>ADD-ON</b> |
|----------------------------------|--------------------|---------------|
| Satin finishes (per lock)        | 606, 612, 613 etc. | 59.00         |
| Bright finishes (per lock)       | 605, 611, 625 etc. | 115.00        |
| UltraShield antimicrobial finish | 626AM, 630AM       | 127.00        |
| Thick door                       | Specify thickness  | 85.00         |
| Tactile both levers/knobs**      | TAC/B              | 120.00        |
| Tactile outside lever/knob**     | TAC/O              | 61.00         |
| Tactile inside lever/knob**      | TAC/I              | 61.00         |
| 7/8" Lip-to-center strike        | 7/8 LTC            | 22.00         |
| 12, 17 Lever Design              | 12, 17             | 66.00         |
| Decorative Lever Design          | 50-91              | 211.00        |
| Extended Life Battery            | 8CE                | 68.00         |

\*\*Not available on #17 levers.

| <b>**COST DEDUCTIONS</b>                          | <b>OPTION CODE</b> | <b>DEDUCT</b> |
|---|--------------------|---------------|
| Less cylinder option (Deduct from complete price) | 0                  | 61 .00        |



## BEST 9KQ Wireless Cylindrical Locks with Wi-Q™ Technology

### How To Order

| 9KQ   | 3                                    | 7   | DV            | 14  | MS   | STK   | 626  |  |
|---|--------------------------------------|---|---------------|---|--|---|--|--|
| Series  | Backset                              | Core Housing  | Function Code | Lever Style   | Rose Style   | Strike Package  | Finish   | Options  |
| 9KQ   | 3 – 2-3/4"<br>4* – 3-3/4"<br>5* – 5" | 0*** – Non-IC and LFIC competitive cylinder (less core)<br>6** – 6 pin non-IC cylinder<br>7 – 7-pin housing; accepts all BEST cores | DV – with key | 14 – Curved with return<br>15 – Contour with angle return<br>16 – Curved without return<br>4 – Round knob | MS***** – Magnetic stripe<br>DV***** – Dual validation (magstripe and keypad)<br>PH – Proximity<br>HID®<br>PKP – Proximity + Keypad<br>SE – HID®<br>iClass® Smart Card | STK – Standard<br>S3 – ANSI<br>S3 7/8* – Lip to center strike<br>S3B* - ANSI (Stike w/ Plastic Box)<br>S3B 7/8* - ANSI (Stike w/ Plastic Box) | 626 690<br>626AM*<br><br>Satin*<br>606 612<br><br>Bright*<br>605 625 | 8CE* – 8 cell battery holder assy with batteries<br>4SW – 4 cell shrink wrap battery<br>P2**** – Phillips head screws<br>LM – Lost motion<br>3/4* – 3/4" throw latch<br>0B** – non-IC zero-bitted<br>COR*** – non IC Corbin Russwin<br>MED*** – non IC Medeco<br>SAR*** – non IC Sargent<br>SCH*** – non IC Schlage<br>YAL*** – non IC Yale<br>SARRC*** - LFIC Sargent<br>CORRC*** - LFIC Corbin<br>YALRC*** - LFIC Yale<br>SCHRC*** - LFIC Schlage<br>AL/O* – Abrasive Lever Outside<br>AL/I* – Abrasive Lever Inside<br>AL/B* – Abrasive Lever Both<br>TL/O* – Tactile Lever Outside<br>TL/I* – Tactile Lever Inside<br>TL/B* – Tactile Lever Both<br>FRL – Full Radius Latch<br>TRK1***** – Track 1<br>TRK2***** – Track 2<br>TRK3***** – Track 3<br>WS – Windstorm Label (NOA Miami-Dade County) |
| <p>NOTE: Wireless locks come with Integrated Door Hardware (IDH) as standard -Request to Exit (RQE), Door Position Switch (DS)</p> <p>* Indicates extra cost option.<br/>           ** Six-pin cylinder in Schlage "C" keyway included with 0B, KA, KD options. Must specify "6" for core housing.<br/>           *** Cylinder not included with COR, MED, SAR, SCH, YAL, CORRC, YALRC, SARRC, or SCHRC options. Must specify "0" for core housing.<br/>           ****T15 Torx security screws are supplied standard.<br/>           *****Must specify track number.</p> |                                      |   |               |   |  |   |  |  |

| FUNCTION DESCRIPTION                            | FUNCTION CODE | COMPLETE WITH COMBINATED CORE |         |          | LESS CORE | NON-IC CYLINDER 0B, KA, KD |
|---|---------------|-------------------------------|---------|----------|-----------|----------------------------|
|   |               | PATENTED*                     | PREMIUM | STANDARD |           |                            |
| <b>MAGNETIC STRIPE READER</b>                   |               |                               |         |          |           |                            |
| 9KQ - Single keyed lock                         | DV            | 2081.00                       | 2081.00 | 2069.00  | 1999.00   | 2050.00                    |
| <b>MAG STRIPE KEYPAD DUAL VALIDATION READER</b> |               |                               |         |          |           |                            |
| 9KQ - Single keyed lock                         | DV            | 2315.00                       | 2315.00 | 2303.00  | 2233.00   | 2284.00                    |
| <b>HID® PROXIMITY READER</b>                    |               |                               |         |          |           |                            |
| 9KQ - Single keyed lock                         | DV            | 2686.00                       | 2686.00 | 2674.00  | 2604.00   | 2655.00                    |
| <b>PKP – PROXIMITY + KEYPAD READER</b>          |               |                               |         |          |           |                            |
| 9KQ - Single keyed lock                         | DV            | 2531.00                       | 2531.00 | 2519.00  | 2449.00   | 2500.00                    |
| <b>SE – HID® ICLASS® SMART CARD READER</b>      |               |                               |         |          |           |                            |
| 9KQ - Single keyed lock                         | DV            | 2481.00                       | 2481.00 | 2469.00  | 2399.00   | 2450.00                    |

| EXTRA COST OPTIONS*              | OPTION CODE         | ADD-ON |
|----------------------------------|---------------------|--------|
| Satin finishes (per lock)        | 606, 612, 613, etc. | 59.00  |
| Bright finishes (per lock)       | 605, 625, 629, etc. | 115.00 |
| UltraShield antimicrobial finish | 626AM               | 127.00 |
| 3/4" throw latch                 | 3/4                 | 31.00  |
| Special backsets                 | 94KQ / 95KQ         | 21.00  |
| Abrasive lever both sides        | AL/B                | 43.00  |
| Abrasive lever outside           | AL/O                | 22.00  |
| Abrasive lever inside            | AL/I                | 22.00  |
| Tactile lever both sides         | TL/B                | 84.00  |
| Tactile lever outside            | TL/O                | 43.00  |
| Tactile lever inside             | TL/I                | 43.00  |
| 7/8" Lip-to-center strike        | 3S 7/8              | 22.00  |
| Strike with plastic box          | S3B or S3B 7/8      | 2.20   |
| Extended Life Battery            | 8CE                 | 68.00  |
| Full radius latch                | FRL                 | 21.00  |

\*Patented pricing shown is for CORMAX patented keying system. Add \$20.00 for Best Preferred patented keying.

| PART DESCRIPTION           | PART NUMBER       | PRICE  |
|----------------------------|-------------------|--------|
| 2-3/4" deadlocking latch   | 8KL3              | 79.00  |
| 3-3/4" deadlocking latch   | 8KL4              | 100.00 |
| 5" deadlocking latch       | 8KL5              | 100.00 |
| Standard strike package    | 8KS2 / 9KS2       | 7.80   |
| ANSI strike package        | 8KS3 / 9KS3       | 24.00  |
| Throw member 6-pin / 7-pin | 71217417 / B54200 | 1.80   |



## BEST EXQ Wireless Exit Trim with Wi-Q™ Technology

### How To Order

| EXQ    | 7  | EV                                  | 15  | MS   | 626   | RHR        | PH2   | RM   |  |
|--------|--|-------------------------------------|---|--|---|------------|---|--|--|
| Series | Core housing   | Function code                       | Lever style   | Trim style   | Finish  | Door hand  | Mfg   | Locking type   | Options  |
| EXQ    | 0 – Less Core Housing<br>7 – 7-pin housing; accepts all BEST cores | EV – With key**<br>NV – Without key | 14 – Curved w/ return<br>15 – Contour w/ angle return | MS*** – Magnetic stripe<br>DV*** – Dual validation (magstripe and keypad)<br>PH – Proximity HID®<br>PKP – Proximity + Keypad<br>SE – HID® iClass® Smart Card | 626 690<br>626AM*<br><br>Satin*<br>606 612<br>613 | RHR<br>LHR | PH2 – Precision Hardware 2000 series<br>VD9** – Von Duprin 98/99 series | RM – Rim<br>MO – Mortise<br>RD – Surface and concealed vertical rods | SH* – Security head screws<br>MT1*** – Track 1<br>MT2*** – Track 2<br>MT3*** – Track 3 |

NOTE: Wireless locks come standard with door position switch (DS), connector/input to connect to a RQE switch inside exit device. (RQE switch must be purchased separately for exit device brand and model).

NOTE: Latch Switch connector is also included for use with a latch switch indicator only on Precision exit devices.

\*Indicates extra cost option; see below.

\*\*The EV function (key override) is not available on the Von Duprin Mortise type.

\*\*\*Must specify track number.

| FUNCTION DESCRIPTION                            | FUNCTION CODE | COMPLETE WITH COMBINATED CORE |         |          | LESS CORE |
|---|---------------|-------------------------------|---------|----------|-----------|
|   |               | PATENTED*                     | PREMIUM | STANDARD |           |
| <b>MAGNETIC STRIPE READER</b>                   |               |                               |         |          |           |
| EXQ - Exit Trim - single keyed                  | EV            | 2533.00                       | 2533.00 | 2521.00  | 2451.00   |
| EXQ - Exit Trim - non keyed                     | NV            | N/A                           | N/A     | N/A      | 2390.00   |
| <b>MAG STRIPE KEYPAD DUAL VALIDATION READER</b> |               |                               |         |          |           |
| EXQ - Exit Trim - single keyed                  | EV            | 2770.00                       | 2770.00 | 2758.00  | 2688.00   |
| EXQ - Exit Trim - non keyed                     | NV            | N/A                           | N/A     | N/A      | 2627.00   |
| <b>HID® PROXIMITY READER</b>                    |               |                               |         |          |           |
| EXQ - Exit Trim - single keyed                  | EV            | 3228.00                       | 3228.00 | 3216.00  | 3146.00   |
| EXQ - Exit Trim - non keyed                     | NV            | N/A                           | N/A     | N/A      | 3085.00   |
| <b>PKP – PROXIMITY + KEYPAD READER</b>          |               |                               |         |          |           |
| EXQ - Exit Trim - single keyed                  | EV            | 2983.00                       | 2983.00 | 2971.00  | 2901.00   |
| EXQ - Exit Trim - non keyed                     | NV            | N/A                           | N/A     | N/A      | 2836.00   |
| <b>SE – HID® ICLASS® SMART CARD READER</b>      |               |                               |         |          |           |
| EXQ - Exit Trim - single keyed                  | EV            | 2933.00                       | 2933.00 | 2921.00  | 2851.00   |
| EXQ - Exit Trim - non keyed                     | NV            | N/A                           | N/A     | N/A      | 2786.00   |

\*Patented pricing shown is for CORMAX patented keying system. Add \$20.00 for Best Preferred patented keying.

| EXTRA COST OPTIONS*              | OPTION CODE   | ADD-ON |
|----------------------------------|---------------|--------|
| Satin finishes (per lock)        | 606, 612, 613 | 59.00  |
| UltraShield antimicrobial finish | 626AM         | 127.00 |
| Security head screws             | SH            | 22.00  |



**BEST Wireless Conversion Kits with Wi-Q™ Technology**

**How To Order**

**Kit works on Offline G and V 9K and 40H Platforms  
Works on Magnetic Stripe, Dual Validation, HID® Proximity will not work on 30H Mortise Platforms.**

| SERIES STYLE   | DESCRIPTION  | PRICE   |
|--|--|---------|
| <b>WQCNKT-1 Cylindrical wireless upgrade kit</b>   |  |         |
| WQCNKT-1<br>Cylindrical wireless upgrade kit   | Kit to convert an Offline 9K V/G standalone lockset to a Wi-Q™ Wireless Lockset.<br>Notes:<br>1) Kit includes a new 9K chassis with new motor, RQE hub and door position switch.<br>2) If the conversion kit will be used on a pre-2009 standalone lock with a HID Proximity Reader, it is highly recommended that a new HID Proximity reader is also purchased. The new style reader will provide better battery life than the pre-2009 HID Proximity Readers. (Part # 731328545---B82399 45HQ HID PROX BEZEL SUB-ASSY HID)   | 1448.00 |
| WQCNKT-2<br>Mortise DV function (without deadbolt) wireless upgrade kit with alarm functionality | Kit to convert an Offline 45H V/G standalone lockset to a Wi-Q™ Wireless Lockset.<br>Notes:<br>1) Kit also contains a new 45H DV mortise case which includes RQE, door position switch, latch position switch and key-override sensor to provide for full alarm functionality.<br>2) If the conversion kit will be used on a pre-2009 standalone lock with a HID Proximity Reader, it is highly recommended that a new HID Proximity reader is also purchased. The new style reader will provide better battery life than the pre-2009 HID Proximity Readers. (Part # 731328545---B82399 45HQ HID PROX BEZEL SUB-ASSY HID)     | 1483.00 |
| WQCNKT-3<br>Mortise TV function (with deadbolt) wireless upgrade kit with alarm functionality    | Kit to convert an Offline 45H V/G standalone lockset to a Wi-Q™ Wireless Lockset.<br>Notes:<br>1) Kit also contains a new 45H TV mortise case which includes RQE, door position switch, deadbolt position switch, and key-override sensor to provide for full alarm functionality.<br>2) If the conversion kit will be used on a pre-2009 standalone lock with a HID Proximity Reader, it is highly recommended that a new HID Proximity reader is also purchased. The new style reader will provide better battery life than the pre-2009 HID Proximity Readers. (Part # 731328545---B82399 45HQ HID PROX BEZEL SUB-ASSY HID) | 1553.00 |

**Upgrade kits must be installed by a BEST Certified Technician for warranty purposes.**



## STANLEY ID Express Station™

### Remote Card Encoding System

The Stanley ID Express Station™ system provides the ability for cardholders to conduct self-managed transactions via a simple and user-friendly interface at a kiosk station. Existing cards can be updated, or temporary cards can be issued. The Stanley ID Express Station™ is only compatible with the B.A.S.I.S. Access Control Software.

| PART NUMBER        | DESCRIPTION  | PRICE    |
|--------------------|--|----------|
| SSK-IDEXPRESS-K    | Stanley ID Express Station™ - Kiosk configuration with 17" Touchscreen monitor, magnetic stripe card dispenser/enrollment station, verification CCTV and Uninterruptible Power Supply, (see note regarding shipping/crating costs)*  | 44411.00 |
| SSK-IDEXPRESS-DC   | Stanley ID Express Station™ - Desktop Complete Configuration with Touchscreen monitor, magnetic stripe card dispenser/enrollment station and verification CCTV. Uninterruptible Power Supply is not included. An exterior placed UPS is recommended. (see note regarding shipping/crating costs)** | 35831.00 |
| SSK-IDEXPRESS-PROX | Additional Proximity card enrollment station for the K option Kiosk configuration  | 1274.00  |
| SSK-IDEXPRESS-Logo | Placement of Customers LOGO on top of Kiosk. Customer must provide art-ready graphic in electronic format  | 673.00   |

**Shipping/crating Charges:**

\*The above unit pricing does not include the crating charge of \$350 and the shipping cost of \$375 per Kiosk purchase. These amounts are in addition to the per unit pricing. (additional rates apply outside of Contiguous United States)

\*\*The above unit pricing does not include the crating charge of \$250 and the shipping cost of \$275 per Desktop purchase. These amounts are in addition to the per unit pricing. (additional rates apply outside of Contiguous United States)

\*\*\*Applications utilizing dual validation locks (Card and Pin) will also require the OpenIT software module for the B.A.S.I.S management system. Refer to the Technical Support Group section for installation pricing.

**Installation Requirement:**

(Provided by Others) Electrical: Requires one (1) standard duplex 110VAC 30 amp circuit located within 2' of the equipment. Communications: Data Connection: Ethernet terminated with a RJ45 located within 2' of the equipment





## Electronic Lock Inside Escutcheon Conversion Kits

### How To Order

**Kit works on Keypad EZ, Offline G, Offline V, NT500, and Wi-Q products.  
Kits do not work on IDH Max products.**

### Cylindrical Conversion Kits

| 9KEKT                              |   | DV               | 626  |  |
|------------------------------------|---|------------------|--|--|
| Series                             | Wireless or non-wireless                  | Function Code    | Finish   | Options  |
| 9KEKT – Cylindrical conversion kit | Q – Wi-Q Wireless<br>Blank – Non-wireless | DV – Latch w/key | 626<br>626AM*<br>Satin*<br>606 612 613<br>Bright*<br>605 625 629 | 8CE* – 8 cell battery holder assy with batteries<br>4SW – 4 cell shrink wrap battery pack<br>P2** – Phillips head screws |

\*Indicates extra cost option; see below.

\*\*T15 Torx security screws are supplied standard.

### Mortise Conversion Kits

| 45HEKT                          | Q   | TV   | 606  |   |
|---------------------------------|---|--|--|---|
| Series                          | Wireless or non-wireless                  | Function Code  | Finish   | Options   |
| 45HEKT – Mortise conversion kit | Q – Wi-Q Wireless<br>Blank – Non-wireless | DV – Latch w/key<br>TV – Deadbolt w/key<br>LV – Deadbolt w/o key<br>NV – Latch w/o key | 626<br>626AM*<br>Satin*<br>606 612 613<br>Bright*<br>605 625 629 | 8CE* – 8 cell battery holder assy with batteries<br>Thick Door* – Specify thickness<br>P2** – Phillips head screws<br>4SW – 4 cell shrink wrap battery pack |

\*Indicates extra cost option; see below.

\*\*T15 Torx security screws are supplied standard.

| CONVERSION KIT                          | PRICE  |
|---|--------|
| <b>9KEKT CYLINDRICAL CONVERSION KIT</b> |        |
| Wi-Q Wireless                           | 254.00 |
| Non-wireless                            | 121.00 |
| <b>45HEKT MORTISE CONVERSION KIT</b>    |        |
| Wi-Q Wireless                           | 254.00 |
| Non-wireless                            | 121.00 |

| EXTRA COST OPTIONS*              | OPTION CODE       | ADD-ON |
|----------------------------------|-------------------|--------|
| Satin finish                     | 606 612 613       | 59.00  |
| Bright finish                    | 605 625 629       | 115.00 |
| UltraShield antimicrobial finish | 626AM             | 127.00 |
| Thick door                       | Specify thickness | 85.00  |
| Extended Life Battery            | 8CE               | 68.00  |

# OMNILOCK®

## WIRELESS

### 45HOM OMNILOCK Wireless Mortise Locks

#### How To Order

| 45HOM  | 7  | DV                                      | 15  | MDVW  | H    | B                     | 626                                | RH                     |  |
|--------|--|---|---|---|------|-----------------------|------------------------------------|------------------------|--|
| Series | Core Housing   | Function Code                           | Lever Style   | Trim Style  | Rose | Housing Finish        | Finish                             | Door Hand              | Options  |
| 45HOM  | 0 – Dummy Cylinder<br>7 – With IC Cylinder (core not included) | DV – Latch w/key<br>TV – Deadbolt w/key | Levers:<br>3 – Tubular/return<br>14 – Curved/return<br>15 – Contour/angle return<br>16 – Curved/no return | MDVW – Dual validation (magstripe and keypad)<br>KW - Keypad Reader<br>MSW – Magnetic stripe<br>PDVW - Dual Validation (HID Proximity and keypad)<br>PHW – Proximity HID® | H    | G - Grey<br>B - Black | 613<br>626<br>690<br>Satin<br>612* | RH<br>RHR<br>LH<br>LHR | DSR* - Door Switch Monitor & RQE<br>RQE* - Request to Exit<br>KOS* - Key override bypass switch<br>LSM* - Latch Switch Monitor<br>Thick Door* - Specify Thickness<br>W* - Weatherized Version (-4°F to +129°F)<br>7/8 LTC* - Flat Lip Strike<br>WS – Windstorm Label (NOA Miami-Dade County) |

Standard Trim is for indoor use only. (W) option is for -4°F to +129°F.

\*Indicates extra cost option

| FUNCTION DESCRIPTION                                     | FUNCTION CODE | WITH CYLINDER | LESS CYLINDER |
|--|---------------|---------------|---------------|
| <b>DUAL VALIDATION READER MAGNETIC STRIPE AND KEYPAD</b> |               |               |               |
| 45HOM- Single Keyed Latch                                | DV            | 3,263.00      | 3,181.00      |
| 45HOM- Single Keyed Deadbolt                             | TV            | 3,294.00      | 3,212.00      |
| <b>KEYPAD READER</b>                                     |               |               |               |
| 45HOM- Single Keyed Latch                                | DV            | 3,224.00      | 3,142.00      |
| 45HOM- Single Keyed Deadbolt                             | TV            | 3,258.00      | 3,176.00      |
| <b>MAGNETIC STRIPE READER</b>                            |               |               |               |
| 45HOM- Single Keyed Latch                                | DV            | 3,224.00      | 3,142.00      |
| 45HOM- Single Keyed Deadbolt                             | TV            | 3,258.00      | 3,176.00      |
| <b>HID PROXIMITY DUAL VALIDATION READER</b>              |               |               |               |
| 45HOM- Single Keyed Latch                                | DV            | 3,516.00      | 3,434.00      |
| 45HOM- Single Keyed Deadbolt                             | TV            | 3,545.00      | 3,463.00      |
| <b>HID® PROXIMITY READER</b>                             |               |               |               |
| 45HOM- Single Keyed Latch                                | DV            | 3,476.00      | 3,394.00      |
| 45HOM- Single Keyed Deadbolt                             | TV            | 3,510.00      | 3,428.00      |

| EXTRA COST OPTIONS*       | OPTION CODE       | ADD-ON |
|---------------------------|-------------------|--------|
| Satin finishes (per lock) | 612               | 65.00  |
| Thick door                | Specify thickness | 70.00  |
| Key Override Sensor       | KOS               | 169.00 |
| Door Switch Monitor & RQE | DSR               | 169.00 |
| Latch Switch Monitor      | LSM               | 58.00  |
| Weather Option            | W                 | 169.00 |
| Request to Exit           | RQE               | 166.00 |

# OMNILOCK®

## WIRELESS

### 9KOM OMNILOCK Wireless Cylindrical Locks

#### How To Order

| 9KOM   | 3                                    | 7   | DV            | 15  | MDVW   | B                     | S3   | 626                                 |   |
|--------|--------------------------------------|---|---------------|---|--|-----------------------|--|-------------------------------------|---|
| Series | Backset                              | Core Housing                                      | Function Code | Lever Style   | Trim Style   | Housing Finish        | Strike Package   | Finish                              | Options   |
| 9KOM   | 3 – 2-3/4"<br>4* – 3-3/4"<br>5* – 5" | 0** – Non-IC Prep<br>7 - BEST IC Handle (no core) | DV – with key | 4 – Knob<br>14 – Curved with return<br>15 – Contour with angle return<br>16 – Curved without return | MDVW – Dual validation (mag-stripe and keypad)<br>KW - Keypad Reader<br>MSW – Magnetic stripe<br>PDVW - Dual Validation (HID Proximity and keypad)<br>PHW – Proximity HID® | G - Grey<br>B - Black | STK – Standard<br>S3 – ANSI<br>7/8 LTC*<br>- Flat Lip Strike | 613*<br>626<br>690<br>Satin<br>612* | ATB - Alternate through-bolt mounting<br>DSR* - Door Switch Monitor & RQE<br>RQE* - Request to Exit<br>W* - Weatherized Version (-4°F to +129°F)<br>FRL – Full Radius Latch<br>COR** - non IC Corbin Russwin<br>MED** - non IC Medeco<br>SAR** - non IC Sargent<br>SCH** - non IC Schlage<br>YAL** - non IC Yale<br>SCHRC** - Schlage large format removable core (14 & 15 lever only)<br>WS – Windstorm<br>Label (NOA Miami-Dade County) |

Standard Trim is for indoor use only. (W) option is for -4°F to +129°F.

\* Indicates extra cost option.

\*\* Cylinder/core not included with COR, MED, SAR, SCH, YAL, or SCHRC options. Must specify "0" for core housing.

| FUNCTION DESCRIPTION                                   | TRIM STYLE | PRICE    |
|--|------------|----------|
| <b>DUAL VALIDATION MAGSTRIPE AND KEYPAD READER</b>     |            |          |
| 9KOM Dual validation reader                            | MDVW       | 2,693.00 |
| <b>KEYPAD READER</b>                                   |            |          |
| 9KOM - Keypad reader                                   | KW         | 2,693.00 |
| <b>MAGNETIC STRIPE READER</b>                          |            |          |
| 9KOM - Magnetic Stripe Reader                          | MSW        | 2,693.00 |
| <b>DUAL VALIDATION HID PROXIMITY AND KEYPAD READER</b> |            |          |
| 9KOM - Proximity dual validation reader                | PDVW       | 2,989.00 |
| <b>HID PROXIMITY CARD READER</b>                       |            |          |
| 9KOM - Proximity card reader                           | PHW        | 2,989.00 |

| EXTRA COST OPTIONS*       | OPTION CODE    | ADD-ON |
|---------------------------|----------------|--------|
| Satin finishes (per lock) | 612, 613       | 65.00  |
| Door Switch Monitor & RQE | DSR            | 169.00 |
| Weather Option            | W              | 169.00 |
| 2-3/4" deadlocking latch  | 8KL3           | 76.00  |
| 3-3/4" deadlocking latch  | 8KL4           | 96.00  |
| 5" deadlocking latch      | 8KL5           | 96.00  |
| Request to Exit           | RQE            | 166.00 |
| 7/8" Lip-to-center strike | 3S 7/8         | 22.00  |
| Strike with plastic box   | S3B or S3B 7/8 | 2.20   |
| Full radius latch         | FRL            | 21.00  |

# OMNILOCK®

## WIRELESS

### OMEM OMNILOCK Electric Modules

#### How To Order

| OMEM    | C                              | MDVW   | B                     |                          |
|---------|--------------------------------|--|-----------------------|--------------------------|
| Backset | Lockset Type                   | Trim Style   | Housing Finish        | Options                  |
| OMEM    | C – Cylindrical<br>M – Mortise | MDVW – Dual validation (magstripe and keypad)<br>PDVW – Dual validation (HID Proximity and keypad)<br>NOTE: Proximity Only and Keypad only are not available | G – Grey<br>B – Black | W* – Weatherized Version |

Standard Trim is for indoor use only. (W) option is for -4°F to +129°F.

\* Indicates extra cost option.

NOTE: Lock Chassis with levers is NOT included

| FUNCTION DESCRIPTION   | FUNCTION CODE | OMNILOCK TRIM ONLY |
|--|---------------|--------------------|
| <b>Cylindrical Dual Validation magstripe and keypad reader</b>     |               |                    |
| OMEMC Cylindrical reader   | MDVW          | 1,847.00           |
| <b>Mortise Dual Validation magstripe and keypad reader</b>         |               |                    |
| OMEMM Mortise reader   | MDVW          | 1,867.00           |
| <b>Cylindrical Dual Validation HID Proximity and keypad reader</b> |               |                    |
| OMEMC - Cylindrical reader   | PDVW          | 2,076.00           |
| <b>Mortise Dual Validation HID Proximity and keypad reader</b>     |               |                    |
| OMEMM - Mortise reader   | PDVW          | 2,093.00           |
| <b>EXTRA COST OPTIONS*</b>   |               |                    |
| Weather Option   | W             | 169.00             |

# OMNILOCK®

## WIRELESS

### OMWMS OMNILOCK Wall Mount Systems

#### How To Order

| OMWMS   | BE   | MDVW   | B                     |                          |
|---------|--|--|-----------------------|--------------------------|
| Backset | Core Housing   | Trim Style   | Housing Finish        | Options                  |
| OMWMS   | BE –<br>(5E Cylinder is included, keyed independently with 2 keys)** | MDVW – Dual validation (magstripe and keypad)<br>PDVW - Dual Validation (HID Proximity and keypad) | G - Grey<br>B - Black | W* - Weatherized Version |

Standard Trim is for indoor use only. (W) option is for -4°F to +129°F.

\* Indicates extra cost option.

\*\*5E Included with Price of Wall Mount Unit

NOTE: Each lock is keyed differently. Must special order to key alike. (Additional Net \$52.50 per order for keyed alike options)

| FUNCTION DESCRIPTION                                   | FUNCTION CODE | PRICE    |
|--|---------------|----------|
| <b>Dual Validation magstripe and keypad reader</b>     |               |          |
| OMWMS Dual validation reader                           | MDVW          | 2,282.00 |
| <b>Dual Validation HID Proximity and keypad reader</b> |               |          |
| OMWMS – Proximity dual validation reader               | PDVW          | 2,561.00 |

| EXTRA COST OPTIONS*             | OPTION CODE | ADD-ON |
|---------------------------------|-------------|--------|
| Weather Option (-4°F to +129°F) | W           | 169.00 |

# OMNILOCK<sup>®</sup>

## WIRELESS

### QASOM Quick Adapter for Pre-2004 Cylindrical Schlage D Lever Locks

#### How To Order

| QASOM         | DVW  | G                     | W                        |
|---------------|--|-----------------------|--------------------------|
| Quick Adaptor | Trim Style   | Housing Finish        | Options                  |
| QASOM         | MDVW – Dual validation (magstripe and keypad)<br>PDVW – Dual Validation (HID Proximity and keypad) | G – Grey<br>B – Black | W* – Weatherized Version |

Standard Trim is for indoor use only. (W) option is for -4°F to +129°F.

\* Indicates extra cost option.

| FUNCTION DESCRIPTION  | FUNCTION CODE | PRICE    |
|---|---------------|----------|
| <b>Dual Validation Reader (magnetic stripe and keypad)</b>    |               |          |
| QASOM Quick adapter with DV                                   | MDVW          | 2,438.00 |
| <b>HID Proximity Dual Validation reader (prox and keypad)</b> |               |          |
| QASOM Quick adapter with proximity and keypad                 | PDVW          | 2,741.00 |

| EXTRA COST OPTIONS*                 | OPTION CODE | ADD-ON |
|-------------------------------------|-------------|--------|
| Weatherized Option (-4°F to +129°F) | W           | 169.00 |

# OMNILOCK®

## WIRELESS

### QAXOM OMNILOCK Wireless Quick Adapter for Exit Devices

#### How To Order

| QAXOM         | 7   | 15  | MDVW  | B                     | 626               | PH2  | RHRB       |                  |
|---------------|---|---|---|-----------------------|-------------------|--|------------|------------------|
| Quick Adapter | Cylinder Housing  | Lever Style                                     | Trim Style  | Housing Finish        | Lever Finish      | Adaptor Plate  | Hand       | Options          |
| QAXOM         | 0 - Non-IC Handle (core not included)<br>7 BEST IC Handle (core not included) | 14 – Curved/return<br>15 – Contour/angle return | MDVW – Dual validation (magstripe and keypad)<br>KW – Keypad Reader<br>MSW – Magnetic stripe<br>PDVW - Dual Validation (HID Proximity and keypad)<br>PHW – Proximity HID® | G – Grey<br>B – Black | 626<br>612<br>613 | CY1 – Corbin/Russwin Yale Series**<br>PH2 – Precision Hardware series**<br>SA7 – Sargent 88 Series**<br>SA8 – Sargent 88 Series**<br>SA9 – Sargent 98 Series**<br>VD9 – Von Duprin 98/99F series** | RHR<br>LHR | W* – Weatherized |

Standard Trim is for indoor use only. (W) option is for -4°F to +129°F.

\* Indicates extra cost option.

\*\* Adapter Plate ships same color as housing finish

| FUNCTION DESCRIPTION  | FUNCTION CODE | PRICE*   |
|---|---------------|----------|
| <b>Dual Validation Reader (magnetic stripe and keypad)</b>    |               |          |
| QAXOM Quick adapter with DV                                   | MDVW          | 3,082.00 |
| <b>Keypad Reader only</b>                                     |               |          |
| QAXOM Quick adapter with keypad only                          | KW            | 3,040.00 |
| <b>Magnetic Stripe Reader</b>                                 |               |          |
| QAXOM Quick adapter with Magnetic stripe reader               | MSW           | 3,040.00 |
| <b>HID Proximity Dual Validation reader (prox and keypad)</b> |               |          |
| QAXOM Quick adapter with proximity and keypad                 | PDVW          | 3,397.00 |
| <b>HID Proximity card reader</b>                              |               |          |
| QAXOM Quick adapter with proximity card reader                | PHW           | 3,397.00 |

\*Core not included

| EXTRA COST OPTIONS*                 | OPTION CODE | ADD-ON |
|-------------------------------------|-------------|--------|
| Weatherized Option (-4°F to +129°F) | W           | 169.00 |
| Thick Door - Specify Thickness      | Thick Door  | 70.00  |

| ADAPTER PLATE CONVERSION CHART |  |  |
|--------------------------------|--|--|
| Adapter Plate                  | VON DUPRIN EXIT DEVICE MODEL #                           | VON DUPRIN TRIM MODEL #  |
| VD9                            | 98F, 99F, 9827-F, 9927-F, 9847-F, 9947-F, 9848-F, 9948-F | 990 DT, 990 NL, 110 NL, 990 TP, 991 K, 992 L, 696 NL, 697 NL, 696 TP, 697 TP, 996 DT, 997 DT |
|                                | PRECISION EXIT DEVICE MODEL #                            | PRECISION TRIM MODEL #   |
| <b>PH2</b>                     | <b>FL-1100 or 2100</b>                                   | <b>1700</b>  |
| PH2                            | FL-1200 or 2200  | 2000   |
| PH2                            | FL-1700 or 2700  | 3900   |
| PH2                            | FL-1800 or 2800  | 1700 / 3900  |
|                                | CORBIN RUSSWIN/YALE EXIT DEVICE MODEL #                  | CORBIN RUSSWIN/YALE TRIM MODEL #   |
| <b>CY1</b>                     | <b>ED5200A / 7100F</b>                                   | <b>755, 759 / 526F, 526F</b>   |
| CY1                            | ED5470B / 7170F90  | 955, 957 / 626F, 627F  |
| CY1                            | ED5860B / 7160F90  | 1310, 1355, 1357 / 535F, 533F, 532F  |
|                                | SARGENT/ARROW EXIT DEVICE MODEL #                        | SARGENT/ARROW TRIM MODEL #   |
| <b>SA7</b>                     | <b>12-8800</b>   | <b>ET, 88C-L, 88D-L, 88K-L, 88L-L, FLL, FLW, MAL, PTB</b>                                    |
| SA8                            | 12-8888  | STS  |
| SA9                            | 12-9800  | ET, FLL, FLW, MAL, PTB, STS  |

# OMNILOCK®

## WIRELESS

### Access Control System Parts and Accessories

| DESCRIPTION  | PART NUMBER   | LIST PRICE |
|--|---------------|------------|
| <b>Magnetic Card and Proximity Card Encoders and enrollment stations</b>                                       |               |            |
| Track 2 magnetic stripe enrollment reader  | OMD-11274     | 566.00     |
| Tracks 1,2 and 3 magnetic stripe encoder   | MSR20633BA    | 3,962.00   |
| Proximity Card enrollment reader   | OMD-11507-002 | 987.00     |
| <b>Magnetic Cards, Proximity Cards, Fobs and Prox Tags</b>   |               |            |
| Track-2 Magnetic-Stripe Card, pre-programmed   | OMD-10983-002 | 27.00      |
| Track-2,3 Magnetic Stripe Card, non-programmed   | OMD-10983-001 | 27.00      |
| Track-2 Default Master ID Card   | OMD-10983-003 | 24.00      |
| Track-3 Magnetic-Stripe Card, pre-programmed   | OMD-10983-004 | 24.00      |
| Track-3 Default Master ID Card   | OMD-10983-005 | 24.00      |
| Cleaning Cards - Box of 50   | VDPCLN        | 195.00     |
| Prox Card II Card, Default Programmer Card   | OMD-11879     | 17.00      |
| <b>Replacement Batteries</b>   |               |            |
| Battery Pack, twin 'AA', Weatherized, set of two battery packs, For Option W only (-20 to +58 degrees Celsius) | OMD-12000     | 53.00      |
| <b>Weather covers and plates</b>   |               |            |
| Weatherized Shroud, Stainless  | OMD-12911     | 427.00     |
| Steel Gate Adapter   | OMD-12293     | 157.00     |
| Stainless Steel Flat Adapter Plate for cylindrical locks (1 each)  | OMD-12061     | 79.00      |
| Locknetics Cover Plate (626) covers CM-series cylindrical holes  | OMD-11586     | 31.00      |

### OMNILOCK WAMS Demo Kit

| NAME                | DESCRIPTION  | PART NUMBER | LIST PRICE |
|---------------------|--|-------------|------------|
| Wireless Survey Kit | Portal Gateway, telescopic mast with Omnidirectional antenna, 802.11 Wireless Router, 3 Wireless Door Beacons, Pelican Case. | WQD-Survey  | 5,790.00   |



# OMNILOCK®

## WIRELESS

### Non-Best Chassis for OMEM

| Schlage ND Series |               | RHO   | L  |  | List Price<br>626, 605, 606,<br>613, 612 | List Price<br>KOS      |        |
|-------------------|---------------|---|--|--|--|------------------------|--------|
| Series            | Function Code | Lever Style   | PREMIUM  |  |  | (Key Over-ride Sensor) |        |
| OMSCH             | ND80          | ATH – Athens<br>OME – Omega<br>RHO – Rhodes<br>SPA – Sparta | P – Standard Schlage C Keyway uncombined core<br>J – Schlage large format IC handle - NO CORE<br>L – LESS Standard core<br>B – BEST format IC handle - NO CORE |  |  | 2,259.00               | 166.00 |

| Schlage L Series |  | 06   | A   | L  | RH  | KOS   | List Price<br>626, 605, 606,<br>613, 612 | List Price<br>KOS |
|------------------|--|--|---|--|---|---|--|-------------------|
| Series           | Function Code                            | Lever Style  | Rose  | Cylinder Prefix  | Door Hand   | Options                                     | (Key Over-ride Sensor)                   |                   |
| OMSCH            | L9070 – Mortise with latch               | 03 – Tubular<br>06 – Contour/angle return<br>07 – Curved/no return<br>17 – Curved/return | A – 2 1/8" Diameter<br>B – 2 9/16" Diameter | P – Standard Schlage Cylinder C Keyway uncombined<br>L – LESS cylinder | RH – Right hand<br>LH – Left hand<br>RHR – Right hand reverse<br>LHR – Right hand reverse | KOS – Key override bypass switch by Stanley | 2,769.00                                 | 72.00             |
|                  | L9453 – Storeroom Mortise with Dead-bolt | 03 – Tubular<br>06 – Contour/angle return<br>07 – Curved/no return<br>17 – Curved/return | A – 2 1/8" Diameter<br>B – 2 9/16" Diameter | P – Standard Schlage Cylinder C Keyway uncombined<br>L – LESS cylinder | RH – Right hand<br>LH – Left hand<br>RHR – Right hand reverse<br>LHR – Right hand reverse | KOS – Key override bypass switch by Stanley | 2,827.00                                 | 72.00             |

| Schlage Mortise Cases Only for Omnilock - NO TRIM IS SUPPLIED (3-4 Week Delivery) |                 |   | List Price             | List Price<br>KOS |
|---|-----------------|---|------------------------|-------------------|
| Part #  | Hand            | Description   | (Key Over-ride Sensor) |                   |
| L9070S  | RH – Right hand | Schlage L9070 Omnilock Style Case without deadbolt - This is the body only, no trim is supplied | 2,360.00               | 72.00             |
| L9453S  | RH – Right hand | Schlage L9453 Omnilock Style Case with deadbolt - This is the body only, no trim is supplied    | 2,720.00               | 72.00             |

# OMNILOCK®

## WIRELESS

### OMNILOCK Software

| DESCRIPTION                                       | PART NUMBER   | PRICE  |
|---|---------------|--------|
| Omnilock Wireless Access Management Software-WAMS | QMS-12418-001 | 849.00 |

\*\* Current maximum capacity of Card Holders at any one wireless reader is 14,000 unique ID's

\*\*Systems sizes above 1024 Wireless Readers are supported. Host may require larger hard drive support for effective data base / file management.

\*\* Windows 7 is acceptable for small systems, mid to large systems may require Windows Server 2008

### Wireless Components

| DESCRIPTION   | PART NUMBER | PRICE  |
|---|-------------|--------|
| <b>Single Door Controllers</b>                                    |             |        |
| Single Door Controller sign-on keypad (required to sign-on a SDC) | WQD-WACPAD  | 518.00 |
| <b>Portal Gateway and Single Door Controller Antennas</b>         |             |        |
| 2.4 GHz Interior Ceiling Mount Omni directional Antenna kit*      | WQD-ACMO    | 311.00 |
| 2.4 GHz Interior/Exterior Wall mount directional antenna kit*     | WQD-AWMD    | 523.00 |
| 2.4GHZ Exterior omni directional mast mount kit**                 | WQD-AEMO    | 565.00 |
| Backside Antenna Kit  | 731142855   | 237.00 |

\* Antenna Kit include antenna, standard mount and 20' cable to connect to Gateway.

\*\* Antenna Kit includes antenna, wall and post mounts and 20' cable to connect to SDC or PG's

|   |               |        |
|---|---------------|--------|
| <b>Conversion Kit (converts Omnilock non-wireless to wireless)</b>                          |               |        |
| Kits consist of Wireless Circuit Board and an RF Transceiver antenna Kit. (non-weatherized) | OMD-12657-01  | 871.00 |
| <b>Transformer - POE Devices - Modem</b>  |               |        |
| Plug in Transformer (wall-mount) with 6' of cable   | OMD-12827     | 44.00  |
| Power over Ethernet Power Supply/Inserter   | OMD-12927-001 | 148.00 |
| Power over Ethernet Active Splitter with Isolation  | OMD-12928-001 | 143.00 |



## QUOTING & ORDERING

Price quotations are based on one (1) shipment to one (1) location, and are valid as identified in the quote but in no case longer than one year from the date of the quote. All exceptions will be evaluated on an individual basis.

All quotation requests will be provided by the dormakaba USA Inc. ("dormakaba USA") Representative where the project is located.

**QUOTING PROCESS AND PROCEDURES:** The following information is necessary to secure a price quotation from dormakaba USA.

- Distributor Name
- Distributor Location
- Distributor Contact Name and Phone Number
- Distributor e-mail contact
- Project Name
- Project Location
- Bid Date
- Architects Name, Phone Number and Architects Location
- Specification Writer Name, Phone Number and Location
- Competitive Influence / Specification
- List of materials to be quoted

Every attempt will be made by dormakaba USA to provide the price quotation in a timely manner. Upon completion, you will receive a copy of the quotation which will also include a valid quotation number. Once the project is secured, a copy of the quotation must accompany your purchase order and be forwarded to dormakaba USA Customer Service Department in Indianapolis for processing.

**NON-STANDARD PRODUCT REQUEST:** Please contact your dormakaba USA Representative to complete a Non-Standard Product Request Form.

All requests should be submitted to the following email address:  
**Email: [product.request.us@dormakaba.com](mailto:product.request.us@dormakaba.com)**

Upon receipt of a special order request, dormakaba USA will review the configuration and determine if dormakaba USA is capable of making the special order product and will provide a response to the customer. If dormakaba USA is able to make the special order product, dormakaba USA will provide a specific sku/configuration to the customer for the special order product. This sku/configuration must be identified on all Purchase Orders. In addition, the Purchase Order must be marked as a "Special Order".

**ORDERING:** The following information is required for dormakaba USA to successfully process any order:

- Itemized Purchase Order (PO)
- dormakaba USA Approved Quote

Please send all orders to [BAS-orderentry.us@dormakaba.com](mailto:BAS-orderentry.us@dormakaba.com) or by fax to 877-835-1030

**NOTE:** For detailed information on how to place an order for dormakaba USA products as well as BEST masterkey services please see the detailed section regarding "Best Ordering".

**ADD ON ORDERS FOR QUOTED PROJECTS:** To place an add-on order from a quoted project the Distributor must include the original quote, PO number and/or dormakaba USA's original order number. Add-On orders will be accepted for a period one (1) year from the original order date. Add-On orders received that are outside of the aforementioned period will be forwarded to the dormakaba USA Representative for re-quote.

**STOCKING ORDERS:** All orders for stock replenishment should be marked as "Stock" and indicate a "Ship To" address that coincides with

the stocking Distributor warehouse location.

**INCOMPLETE ORDER PROCESS:** All orders are screened upon receipt for complete information. If an order is received incomplete, dormakaba USA Customer Service will make one (1) attempt to contact a Distributor directly for the missing requirements. If the information is not made available to dormakaba USA at that time the order will be referred to the local dormakaba USA Representative for resolution. All incomplete orders will be cancelled if not resolved after fourteen (14) calendar days.

**PRICE DISCREPANCY PROCESS:** All entered orders are reviewed by dormakaba USA Customer Service for accuracy and pricing consistency between the Distributor and dormakaba USA. Any order determined by dormakaba USA, in its sole and absolute discretion, to have a value greater than the Total Price shown on the Distributor purchase order will be held by dormakaba USA for a Price Discrepancy. dormakaba USA quotes are also reviewed to ensure that they are complete, approved, and match the PO. Due to pricing sensitivity, all price discrepancies must be resolved exclusively by your dormakaba USA Representative.

**ORDER CANCELLATION/CHANGES:** All requests for Order Cancellations and Changes (Quantity, Shipping, Finish, Function, etc) should be sent directly to dormakaba USA Customer Service. Requests via phone will be accepted, but must be accompanied by a written request. Factory Order Number, PO Number, Account Info, and Detailed Changes must be clearly indicated. Change requests can be submitted via the following methods:

**Email: [BAS-cshelp.us@dormakaba.com](mailto:BAS-cshelp.us@dormakaba.com)**  
**Fax: 1-877-835-1030**

All order cancellations or changes will be subject to a cancellation fee as defined in dormakaba USA's Terms and Conditions of Sale.

**PRODUCTION SCHEDULING AND "DO NOT SHIP BEFORE" REQUESTS:** All orders are scheduled for production and shipping based on current production lead times and availability. Scheduling is completed only when an order is released from both credit and pricing review.

Exceptions to this policy are made only when the PO is clearly marked: "Do Not Ship Before" followed by the date. (*Required Date, Expected Date, etc. do not apply*) These orders will be scheduled to ship on or after the date listed.

Changes to "Do Not Ship Before" dates are required in writing and should be sent to: [BAS-cshelp.us@dormakaba.com](mailto:BAS-cshelp.us@dormakaba.com).

Be advised, orders not clearly marked with a "Do Not Ship Before" designation will be payable within normal terms from the actual shipment date.

**EXPEDITE REQUESTS:**

- Expedite requests will be reviewed and accommodated by dormakaba USA based on production lead times and availability.

**Email: [BAS-expediterequest.us@dormakaba.com](mailto:BAS-expediterequest.us@dormakaba.com)**

- See the then current dormakaba USA Quick Ship Program for details.

**WHOLESALE PURCHASE:** Distributors are also free to utilize dormakaba USA's Authorized Wholesalers to purchase product. dormakaba USA does not make any guarantee of availability or pricing for purchases from an Authorized Wholesaler and the discounts afforded to Distributor by dormakaba USA shall not apply to purchases from an Authorized Wholesaler. The terms and conditions and price of product shall be as mutually agreed between Distributor and Wholesaler.



## BEST ORDERING

**ORDER ENTRY REQUIREMENTS:** The following information is required for dormakaba USA Inc. ("dormakaba USA") to successfully process an order for dormakaba USA Best Products:

**Orders Requiring Factory Master Key Services:**

- Itemized Purchase Order (PO)
- Completed **Keying Request Information Form**
- Hardware Schedule in support of a construction project
- dormakaba USA Approved Quote

**Orders NOT Requiring Factory Master Key Services:**

- Purchase Order
- General Contractor information (City/State/Zip)
- dormakaba USA Approved Quote

**KEYING SYSTEM ORDERS:** All orders of keying systems specifying delayed fulfillment must be fulfilled within twelve (12) months of the order date. Said request for fulfillment must include complete keying instructions for the order to be acknowledged with an estimated delivery date. Failure to properly request fulfillment of the order within twelve (12) months of the order date will make the order void and nonrefundable.

Pricing for all new construction key operated locks include the following:

- Combined or uncombined permanent cores will be provided with 2 keys per core.
- "Core only" orders will be provided with 2 keys per core.

Pricing for all retrofit key operated locks include the following:

- Combined cores will be provided with 1 key per core.
- Uncombined cores will be provided with 0 keys. All keys will need to be purchased separately.

All new purchase orders should be e-mailed to your local dormakaba USA Representative or [BAS-orderentry.us@dormakaba.com](mailto:BAS-orderentry.us@dormakaba.com).

**HARDWARE SCHEDULE & NEW CONSTRUCTION PROJECT ORDERS:** A hardware schedule should be submitted for all new construction projects. A hardware schedule is a listing of all builders hardware items related to a particular construction job. It is approved by the architect (or an entity performing that function). A hardware schedule of Best products is one in which the material ordered is compatible for installation as required in the schedule. Remember complete door schedules include door number, door location, and type of hardware. An example of a preferred hardware schedule format is illustrated below:

| Project Sample  |                   |                                 |            |
|-----------------|-------------------|---------------------------------|------------|
| Hardware Set 01 |                   |                                 |            |
| 1               | SGL DOOR 101A     | CORRIDOR 100 FROM CLASSROOM 101 | 90 DEG RHR |
|                 |                   | 3/0 x 7/0 x 1-3/4 HME x SWD     |            |
| 3               | HINGES            | FBB179 4.5 x 4.5                | 652        |
| 1               | CLASSROOM LOCKSET | 93K 7 R 14D S3 STD              | 626        |
| 1               | CLOSER            | D-4551 CS                       | 689        |
| 1               | KICKPLATE         | 8" x 34" x .050                 | 630        |
| 3               | MUTES             |                                 | GREY       |

**COMBINATED CORE ONLY ORDERS:** All Core-Only orders, in an amount of 25 cores or more, require a Hardware Schedule, Keying Request Information Form, and Itemized Purchase Order (PO).

**LESS CORE LOCK ORDERS PURCHASED DIRECTLY FROM dormakaba USA:** Less core lock orders generally apply to orders where the end user is providing their own permanent cores.

**CABINET LOCK ORDERS:**

The following information must be provided for Cabinet Lock Orders:

- End User Name
- End User Address Information (*Street/City/State/Zip*)
- End User Phone
- End User Fax and/or e-mail

## DISTRIBUTOR PERMANENT KEYING

**POLICY:** Locks when ordered for construction projects to include "Final Keying" will be provided to Distributor with construction core access, whereby plastic thumb turns are supplied for use during construction. Additionally, brass construction cores can be purchased by the Distributor, upon request, to secure exterior doors or special interior doors.

The permanent masterkeyed cores are shipped directly to the end user upon written approval of the final keying. It is the responsibility of the Distributor to collect all temporary construction cores after use.

**PROCESS:**

- 1) Distributor places complete order with dormakaba USA Customer Service, Indianapolis
- 2) Distributor, KSS, and End User Consultant (EUC) receive acknowledgement of order with expected ship date.
- 3) KSS/Distributor contacts the end user within a reasonable period of time after receipt of purchase order or acknowledgment to begin the permanent keying process.
- 4) KSS/Distributor works with end user to define keying requirements.
- 5) Once keying requirements are finalized and approved, production of cores and keys begins.
- 6) Cores and keys are shipped to end user or end user delegate (*NOTE: Unless special arrangements are made the end user is responsible for permanent core installation*).

**Complete Order Checklist**

- PO Number
- Hardware Schedule
- Completed **Keying Request Information Form**

The KSS/Distributor works directly with the end user to acquire keying instructions for the permanent masterkeyed cores and keys, including both new system design and existing system expansion, according to the project requirements. The KSS/Distributor also manages the process from keying instructions to delivery and can serve as a point of contact for information on the progress of permanent core/key delivery completion.



## BEST ORDERING (continued)

### SERVICE DELIVERY:

Permanent Core delivery is contingent upon several factors such as:

- The negotiated delivery dates as determined between the end user, Distributor and dormakaba USA during the keying review and design processes;
- End user's written approval of the keying instructions;
- Size and complexity of the keying system being produced; and
- dormakaba USA's receipt of payment from the Distributor.

### GENERAL:

- Remember to furnish door and location information for all "tag-in" orders (add-ons to initial project orders).
- If you have advanced knowledge that your project will be phased and require multiple orders from dormakaba USA, please include these in your order.
- A master hardware schedule for phased projects is always preferred.

## CONSTRUCTION CORE ORDERS

All keyed locks shipped from dormakaba USA for new construction projects in which cores have been ordered will receive disposable black plastic (non-keyed) construction cores at no additional charge.

Disposable black plastic cores for less-core orders may be purchased separately for \$1.50 net.

Standard brass (keyed-alike) construction cores may be purchased for a net price of \$8.00 each.

No further discount will be applied.

Brass construction cores shall be 7-pin, A keyway and have a GREEN face.

Brass construction cores are shipped with one operating key per ten (10) cores and one control key per twenty (20) cores; additional keys may be purchased for \$4.40 list.

**Construction cores do not have the degree of security that the owner's permanent masterkeyed cores provide. Construction cores are used for controlling access to premises during construction and ARE NOT INTENDED FOR USE WHEN PREMISES ARE OCCUPIED OR FURNISHED IN ANY MANNER.**

| CONSTRUCTION CORES AND KEYS |   |  |
|-----------------------------|---|--|
| Part Number:                | Description   | Net price each (if purchased separately) |
| 7181139                     | Disposable Core (Black Plastic)                                 | \$1.50 Net                               |
| 7190246 (5c)                | Standard Brass Keyed Alike 5c construction Core - Green Face    | \$8.00 Net                               |
| 7186163 (6p)                | Standard Brass Keyed Alike 6 pin construction Core - Green Face | \$8.00 Net                               |
| 7190224 (7p)                | Standard Brass Keyed Alike 7 pin construction Core - Green Face | \$8.00 Net                               |
| 7148872                     | Additional Operating Key  | \$6.00 List                              |
| 7147449                     | Additional Control Key  | \$6.00 List                              |

\*No further discounting on Construction Core Net Pricing

**RETURN OF CONSTRUCTION CORES:** Brass construction cores may be returned for \$2.50 credit per re-usable core to be applied toward the next purchase. A Returned Goods Authorization (RGA) must be obtained and accompany the returned material.

**dormakaba USA is not responsible for collection or return of construction cores.**

**BEST PINS:** Best pins shall be used solely in combination with Best Core products. Use of other pins may void any associated product warranty and may result in termination of the Distributor's agreement with dormakaba USA, in dormakaba USA's sole discretion.



## RETURNED AUTHORIZATION (RA)

**RA REQUESTS:** A Return Authorization Form ("RA") must be utilized to return defective products **still under warranty** or products deemed repairable by dormakaba USA Inc. ("dormakaba USA"). All products returned to dormakaba USA must have a correct Return Authorization (RA) number applied to the outside of the shipping carton. All products must be returned within sixty (60) calendar days of RA issue date. This process can take up to seven (7) days after product is received at dormakaba USA's factory. If a defective product presents a security risk, an advance replacement may be requested.

**RA PROCESS:** Requests for warranty related returns can be initiated by submitting an e-mail to **BAS-rgacreditgrp.us@dormakaba.com**.

The RA Request Form must be completed entirely to process an RA. The following information will be needed:

- End User Name
- Account Number
- Contact Name
- Phone Number
- Purchaser Order Number
- Sales Order Number
- Item Number
- Item Quantity
- Description of the Problem

1. Upon review and approval of the submitted RA request, a claim number is logged and provided back to the requestor by a dormakaba USA Team member.
2. Once a claim number is issued, this number should be noted on all references and communications regarding the applicable situation to ensure a claim is easily identified.
3. Defective product should be returned to the address below. The shipment must be marked with the approved RA claim number to ensure prompt processing and attention. All shipping charges prepaid by customer.

dormakaba USA Inc.  
Attn: Returns Department  
6161 East 75<sup>th</sup> Street  
Indianapolis, IN 46250

4. When material is received at dormakaba USA's factory, dormakaba USA will assess and determine the nature of the defect.
5. Defective goods are replaced upon dormakaba USA's determination.
6. Credit for material and freight is issued only if deemed appropriate by dormakaba USA. If approved, credit is initiated and a credit memo is mailed to the Distributor within fifteen (15) business days.

### **PURCHASE ORDERS:**

A Purchase Order (PO) will be required if the Product is:

1. Defective and not under warranty, or
2. An advance replacement is required without verification of whether the product is defective and under warranty.

Please send Purchase Orders to the following:

- Preferred Method e-mail:  
**BAS-rgacreditgrp.us@dormakaba.com**
- Fax: 1-877-835-1030

May 2018



## RETURNED AUTHORIZATION (RA) NON-WARRANTY

**RA POLICY:** A Return Authorization Form ("RA") must be utilized to return products that are not defective and otherwise in a resalable condition. Only goods with an invoice date of less than one (1) year will be considered for a non-warranty related return. All materials returned to dormakaba USA Inc. ("dormakaba USA") for any reason (other than warranty), must have a correct RA number applied to the outside of the shipping carton. A thirty percent (30%) re-stocking charge (of the purchase price) will be applied to the Distributor's account for orders returned, including orders that were placed by customer in error. Transportation charges of returned goods must be prepaid by the Distributor. All goods must be returned within sixty (60) calendar days of RA issue date. All goods must be returned in original packaging and be in resalable condition. Product not returned in saleable condition is subject to disposal by dormakaba USA with no credit issued. Commercial Hardware items that are special made to order items will not be returned under any circumstances.

**RA PROCESS:** Requests for non-warranty related returns can be initiated by submitting an e-mail to **BAS-rgacreditgrp.us@dormakaba.com**.

The RA Request Form must be completed entirely to process an RA. The following information will be needed:

- Company Name
- Account Number
- Contact Name
- Phone Number
- Purchaser Order Number
- Sales Order Number
- Item Number
- Item Quantity
- Description of the Problem

1. Upon review and approval of the submitted RA request, a claim number is logged and provided back to the requestor by a dormakaba USA Team member:
2. Once a claim number is issued, this number should be noted on all references and communications concerning said RA.
3. Product should be returned to the address below. The shipment must be marked with the approved RA claim number to ensure prompt processing and attention. All shipping charges prepaid by customer.

dormakaba USA Inc.  
 Attn: Returns Department  
 6161 East 75<sup>th</sup> Street  
 Indianapolis, IN 46250

4. The RA will be processed once material is received at dormakaba USA's factory provided it is received in its original packaging and is in saleable condition.
5. Credit is issued to the Distributor account and a credit memo is mailed to the Distributor.

## FULFILLMENT ISSUES

Any quality issues (missing parts, wrong parts, handling, finish, etc) should be submitted electronically to: [BAS-rgacreditgrp.us@dormakaba.com](mailto:BAS-rgacreditgrp.us@dormakaba.com) or your Local dormakaba USA Representative.

Please reference your original Purchase Order (PO) Number, Factory Order Number, Distributor Account, Contact Information (E-mail/Fax), and include a detailed description of the issue.

**1) ITEMS MISSING FROM A SHIPMENT:** If you have signed your shipment short, dormakaba USA Customer Service will promptly issue a No Charge replacement order for the missing products.

If the shipment was not signed short but after review, dormakaba USA Customer Service determines (based on shipping weights, packing lists, etc) that the order was indeed shipped short, a No Charge replacement will be issued.

If dormakaba USA Customer Service cannot verify a shipping error, an advance replacement order will be entered, charged, and expedited to the Distributor. The quality issue will be forwarded to the Return Authorization Credit Group for resolution.

If it is determined that the item was omitted from the order due to a dormakaba USA order entry error, a change order will be entered and expedited for the missing products.

Please see price book for further detail.

**2) WRONG ITEMS RECEIVED** (parts, handling, function, finish, etc): Advanced replacements will be issued for any wrong items received. **Such orders will be charged based on pricing/ discounts from the original order.** The issue will be forwarded to dormakaba USA's Return Authorization Credit Group for resolution.

Any quality issue that is determined to be either a dormakaba USA order entry and/or manufacturing error will have an advanced replacement order entered and will be expedited. An RA will be issued to return the incorrect products. No re-stock fee will apply for dormakaba USA order entry and/or manufacturing errors.





## KEYING REQUEST INFORMATION FORM

**MUST BE SUBMITTED WITH COMPLETE INFORMATION,  
INCLUDING P.O. & HARDWARE SCHEDULE**

**CUSTOMER  
NUMBER:**

Quote #: \_\_\_\_\_  
If received

Discount %: \_\_\_\_\_

P.O. #: \_\_\_\_\_

Price List: \_\_\_\_\_

### **REQUIRED INFORMATION REGARDING dormakaba USA Inc. DISTRIBUTOR**

Distributor: \_\_\_\_\_

Distributor P.O. #: \_\_\_\_\_

Distributor Account #: \_\_\_\_\_

Project Manager: \_\_\_\_\_

Project Manager Mobile: \_\_\_\_\_

Project Manager E-mail: \_\_\_\_\_

Address: \_\_\_\_\_

City, State, Zip: \_\_\_\_\_

Phone: \_\_\_\_\_

Fax: \_\_\_\_\_

### **REQUIRED INFORMATION REGARDING PROJECT CONTRACTOR**

Contractor: \_\_\_\_\_

Job Name\*: \_\_\_\_\_

Contact Person: \_\_\_\_\_

Contact Mobile: \_\_\_\_\_

Contact E-mail: \_\_\_\_\_

### **REQUIRED INFORMATION REGARDING THE END USER**

Company\*: \_\_\_\_\_

Contact Person\*: \_\_\_\_\_

Contact E-mail: \_\_\_\_\_

Contact Phone #: \_\_\_\_\_

School Name (if applicable): \_\_\_\_\_

School District (if applicable): \_\_\_\_\_

Permanent Core Due Date\*: \_\_\_\_\_

Building Turnover Date: \_\_\_\_\_

Project Address\*: \_\_\_\_\_

City, State, Zip\*: \_\_\_\_\_

Phone\*: \_\_\_\_\_

Fax: \_\_\_\_\_

End User Customer #: \_\_\_\_\_

Masterkey Account #: \_\_\_\_\_

Keyway: \_\_\_\_\_

NOTE: Failure to provide complete and accurate end user information will result in delays in processing and supply of permanent core and key orders.  
Failure to include this form with your order and the hardware schedule may result in the order being processed "less core".

\*REQUIRED Field





**BEST ACCESS SOLUTIONS, INC ("Best") PATENTED MASTERKEY SYSTEM SECURITY AUTHORIZATION FORM**

The purpose of this form is for the end user to designate representatives who are authorized to place an order for Best patented cores or keys and to confirm the correct shipping address for Best Patented product. It is the responsibility of the Distributor to ensure that the end user completes a Security Authorization Form and submits it to dormakaba USA with each order.

The Best Patented Masterkey System provides a higher level of protection against unauthorized key duplication and crossovers. To help ensure that Best patented cores and keys do not end up in the possession of unauthorized personnel, dormakaba USA will only authorize sales and shipment of Best patented cores and keys to the individuals noted on this form. Please complete this form carefully as dormakaba USA and/or its Authorized Distributor will strictly adhere to this information.

**END USER:**

\_\_\_\_\_  
End User Name

\_\_\_\_\_  
Account Number

**SECURITY AUTHORIZED PERSONNEL:** Please provide the names of all security personnel who are authorized to place purchase orders for End User's Best Patented Masterkey Systems.

**1.**

\_\_\_\_\_  
Name

\_\_\_\_\_  
Street Address

\_\_\_\_\_  
Title

\_\_\_\_\_  
City, State, Zip

\_\_\_\_\_  
Phone Number

\_\_\_\_\_  
E-mail Address

\_\_\_\_\_  
Fax Number

\_\_\_\_\_  
Signature/Date

**2.**

\_\_\_\_\_  
Name

\_\_\_\_\_  
Street Address

\_\_\_\_\_  
Title

\_\_\_\_\_  
City, State, Zip

\_\_\_\_\_  
Phone Number

\_\_\_\_\_  
E-mail Address

\_\_\_\_\_  
Fax Number

\_\_\_\_\_  
Signature/Date

**3.**

\_\_\_\_\_  
Name

\_\_\_\_\_  
Street Address

\_\_\_\_\_  
Title

\_\_\_\_\_  
City, State, Zip

\_\_\_\_\_  
Phone Number

\_\_\_\_\_  
E-mail Address

\_\_\_\_\_  
Fax Number

\_\_\_\_\_  
Signature/Date



**BEST PATENTED MASTERKEY SYSTEM SECURITY AUTHORIZATION FORM (continued)**

**AUTHORIZED DISTRIBUTOR:** Please insert the name below of the Authorized Distributor that you assign and authorize to place orders for Best Patented Product on your behalf.

1. \_\_\_\_\_

|           |                               |
|-----------|-------------------------------|
| _____     | _____                         |
| Name      | Street Address                |
| _____     | _____                         |
| Title     | City, State, Zip              |
| _____     | _____                         |
| Signature | Phone Number / E-mail Address |
| _____     |                               |
| Date      |                               |

**SHIPPING ADDRESS:** Please provide the address where you would like all Best Patented Product shipped.

\_\_\_\_\_

Department

\_\_\_\_\_

Street Address

\_\_\_\_\_

City, State, Zip

**ACCEPTABLE METHOD FOR PLACING ORDERS:** please identify below the method that you authorize for placement of orders for Best Patented Product.

**Signature Verification** – dormakaba USA may only accept purchase orders that have been signed by one of the individuals designated on this form by the End User. Best will verify that the signatures match before initiating activity on the order. dormakaba USA will not initiate activity until the original P.O. has been received.

**Email Verification** – dormakaba USA may accept electronic purchase orders from the email accounts designated on this form by the End User. dormakaba USA will verify that the email account sending the purchase order has been designated as an authorized purchaser. Purchase orders received from accounts not listed will not be accepted.

**Fax Verification** – dormakaba USA may accept purchase orders via fax from one of the individuals designated on this form by the End User. dormakaba USA will verify that the individual placing the order has been designated as an authorized purchaser.

**BEST MASTERKEY CODE & MASTERKEY SERVICE POLICY:** In accordance with the Best Masterkey Code and Masterkey Service Policy, all Best Patented Masterkey Codes and combinations are available for distribution solely to end users and select Authorized Distributors. To assist in reducing the possibility of duplication within a Best Patented Masterkey System and ensure security, all Best Patented Masterkey Code extensions and next in series codes should be made or approved by Best Masterkey personnel and/or the Distributors that have been authorized by dormakaba USA to have access to Best Patented Masterkey Codes, un-combinated cores and key blanks. Duplication or release of Best Patented Masterkey Codes to non-authorized people or organizations, including, but not limited to, unauthorized distributors, wholesalers, private locksmiths, other lock manufacturers, architects, or contractors violates dormakaba USA’s ownership rights and is strictly prohibited.

By signing below, End User acknowledges that 1) the information provided above is accurate and correct and 2) that any unauthorized use including, but not limited to, the transmission or dissemination of Best Patented Masterkey Codes, without the express written consent of dormakaba USA is strictly prohibited.

End User Signature: \_\_\_\_\_

Title: \_\_\_\_\_ Date: \_\_\_\_\_



**RETURN AUTHORIZATION FORM REQUEST**

- Return for Replacement**       **Return for Credit**

Date of Request: \_\_\_\_\_  
 Original Order: \_\_\_\_\_  
 Date of Request: \_\_\_\_\_  
 Original P.O.: \_\_\_\_\_  
 Invoice #: \_\_\_\_\_  
 Customer Name: \_\_\_\_\_  
 Account Number: \_\_\_\_\_  
 Address: \_\_\_\_\_  
 City: \_\_\_\_\_  
 State: \_\_\_\_\_ Zip: \_\_\_\_\_  
 Contact Name: \_\_\_\_\_  
 E-mail: \_\_\_\_\_  
 Phone: \_\_\_\_\_

**NATURE OF PROBLEM**

- Manufacturing Defect  
 Warranty Evaluation  
 Missing Parts  
 Wrong Material Received  
 Wrong Material Ordered  
 Wrong Quantity  
 Return Inventory  
 Other: \_\_\_\_\_

**NOTE:** All returns shall be subject to dormakaba USA Inc.'s current Terms of Sale and Warranty as outlined in the price catalog.

- Ship Replacement Material to Address Above**       **Ship Replacement Material to Address on Order**

**DETAILED DESCRIPTION OF DEFECT OR REASON FOR RETURN**

\_\_\_\_\_  
 \_\_\_\_\_  
 \_\_\_\_\_

| RETURN MATERIAL |          |                      |                     |
|-----------------|----------|----------------------|---------------------|
| Line Item #     | Quantity | Product Nomenclature | Product Description |
|                 |          |                      |                     |
|                 |          |                      |                     |
|                 |          |                      |                     |
|                 |          |                      |                     |
|                 |          |                      |                     |
|                 |          |                      |                     |
|                 |          |                      |                     |
|                 |          |                      |                     |
|                 |          |                      |                     |
|                 |          |                      |                     |

Please e-mail completed form to [BAS-rgacreditgrp.us@dormakaba.com](mailto:BAS-rgacreditgrp.us@dormakaba.com) or Fax to 1-877-835-1030



6161 East 75th Street  
Indianapolis, IN 46250 USA

Phone 855-365-2407

[bestaccess.com](http://bestaccess.com)