



DOOR HARDWARE

PRICE BOOK #14

PART # 5-500-2021

EFFECTIVE 1/1/2021

CONTACT INFO

Address

Hager Companies
139 Victor Street
Saint Louis, MO 63104

Phone & Fax

Toll Free: 800 325 9995
Headquarters: 314 772 4400
Main Fax: 800 782 0149

Online

webmaster@hagerco.com
orders@hagerco.com
www.hagerco.com

CONTACT INFORMATION

Corporate Office

139 Victor Street
St. Louis, Missouri 63104

800-325-9995 (Sales and Service)
800-255-3590 (Main Office)
314-772-4400 (Local Main Office)
800-782-0149 (Fax)

webmaster@hagerco.com
orders@hagerco.com
www.hagerco.com

Montgomery Operations

150 Folmar Parkway
Montgomery, AL 36105
Tel: 334-284-4700 (Main Phone)

Southwest Office

14241 Firestone Blvd, Suite 400
La Mirada, CA 90638
Tel: 562-652-9135(Main Phone)

Dubai Office

PO Box 17967 / FZS1-AB05
Jebel Ali Free Zone, South 1
Dubai – UAE
Tel: +971-4 886-0360

China Office

North Region, 3/F, No.5-2 Building, Zhuhai Park,
Zhuhai Macau Cross Border Industrial Zone,
Zhuhai Guangdong Province China



General Information

TERMS AND CONDITIONS

General

Prices indicated will be in effect from the date on the cover and are subject to change without notice. If, under any law now or hereafter passed, the seller is required to pay a tax on sales or an excise tax, the amount of these taxes will be added to the invoice value. We shall not be responsible for any loss or damage resulting from delay in filling orders caused by fire, flood, strikes, differences with workmen, government regulations, accidents, transportation delays, shortages of materials, or other causes beyond our control. Should raw material prices rise substantially, it may become necessary to add a surcharge by material type at the time of shipment. Orders are processed in order of receipt, but lead times will vary in relation to production specifications. Errors or omissions in published prices are subject to correction.

Payments

Accounts are net cash 30 days, or 1% for cash if paid within 15 days following the date of invoice. Accounts unpaid at expiration of 60 days from the date of invoice will be subject to a late payment charge of 1-1/2% per month of the total balance. Also, accounts unpaid after 60 days will be subject to C.O.D. shipments. Accounts unpaid after 90 days will be placed for collection. All collection charges, attorney fees, and court costs will be added to the amount due. An NSF (insufficient fund) check fee in the amount of \$30.00 will be added to the account.

Minimum Order Charges

Orders with a net value of less than \$50.00 will be invoiced at \$50.00.

Minimum Annual Purchase Requirement

A minimum annual amount of \$15,000.00 is required to maintain open account status with Hager Companies.

Packaging

- A charge of \$100.00 net will be made when requested to itemize and special package in accordance with such schedules.
- A charge of \$50.00 net will be made when requested to make changes on itemized jobs after the orders have been processed.
- A charge of \$16.40 net for crating certain products will be added to invoices at time of shipment.

Quick Ship

The items throughout this price book that have prices in **bold and red** are items included in the Hager Quick Ship Program - they will ship in three days or less. When ordering these products, please visit www.hagerco.com and click on 'Quick Ship' in the footer. You will be prompted to log in with your My Hager account name and password and then you may begin ordering.

Shipments and Freight Charges

All shipments are F.O.B. Point of Origin. Freight prepaid on shipments having a value of \$2,000.00 net or more, route of our selection. Less than \$2,000.00 net shipped prepay and add. Shipments by Express, Air Freight, or United Parcel Service are F.O.B. Point of Origin, without any freight allowance. Any request for shipments not falling under these guidelines may be subject to a handling charge. Hager will not provide consignee or third party freight billing.

There will be a \$25.00 net charge for furnishing proof of delivery receipt. This charge will be canceled if delivery was not made. Proof of delivery may be obtained by visiting www.hagerco.com and establishing an account with "My Hager." Due to size limitations by certain carriers, some orders may require LTL shipment.

Please note that for next day air shipments, written consent with an authorized signature must be sent via fax or e-mail to Hager Companies before an order will be released for overnight delivery. Next day air requests must be received prior to 1:00 p.m. CDT.



Cancellations and Make-to-Order Items

Orders for non-stock goods, accepted by Hager, are non-cancelable except with prior written consent, and then subject to a service charge based on the manufacturing expenses incurred. Under no circumstances will non-stock, make-to-order or discontinued product be accepted for return unless it is due to a Hager error.

A. Rights of Return:

1. **Restrictions:** Unless the Customer has a separate written agreement with Hager Companies, the return of product purchased from Hager is subject to the following restrictions:
 - a. **Authorized Returns Only:** No credit will be issued for returned goods unless such return is authorized by our St. Louis office. All returns are subject to review and approval by Sales Management and will be handled on an account by account basis.
 - b. **Return Goods Authorization Document:** Product will not be accepted unless it is accompanied by a Return Goods Authorization (RGA). No RGA will be issued for less than \$25.00.
 - c. **35% Restocking Fee:** All returns are subject to a minimum 35% handling and restocking fee at Hager Companies sole discretion.
 - d. **Timeline for Product Returns:** The timeline for returns is as follows:
 - i. **North American Shipments** (U.S., Canada, Mexico, Puerto Rico)
 1. Notification to Hager – within 6 months from date of shipment.
 2. Receipt of return by Hager – within 60 days of notification to Hager.
 - ii. **International Shipments**
 1. Notification to Hager - within 6 months from date of shipment.
 2. Receipt of return by Hager - within 120 days from notification.
 - e. **Condition:** Return goods, and packaging, must be in sellable condition or no credit will be issued, and goods will be destroyed.
 - f. **Direct Returns Only:** Return goods authorization must be requested directly by the Hager Companies customer. Third party customers will not be allowed to return product and all unauthorized merchandise will be returned to the sender and the Hager customer will be invoiced for additional shipping charges incurred.
2. **Return Shipping:** Freight terms will be specified on the RGA. The Customer is responsible for shipping charges and risk of loss and damage on all return shipments.
3. **Replacement Order and Credit:** The Customer may return product and Hager Companies will assist in its replacement or grant credit against future purchases in an amount equal to the original purchase price and freight paid for the product less any applicable restocking fees.
4. **Non-Returnable Merchandise:** Returns are also subject to the additional policies below. If the Customer fails to return Product within the applicable return policy period or if the Product does not meet the criteria under this Return Policy, the Product is considered accepted by the Customer and not returnable.

B. Freight Damaged Products: In the event that packages are damaged during transit to customer, please follow the guidelines in the Hager Freight Policy.

1. If damaged products (noted and/or concealed) are accepted from the Carrier, contact Hager Companies Customer service within 5 calendar days after receipt of shipment to arrange for carrier inspection and a pickup of the damaged products.
2. As per the Hager Companies' Freight Policy, all damages must be noted on the carrier delivery record prior to the driver leaving the Customer premises. Please save the Product and all original packaging. Timely notification of the damage is necessary to file a damage claim with the freight carrier and avoid delays in returns and replacements.



General Information

C. Order Quantity Discrepancies: All order discrepancies (shortages or overages) must be reported to the Hager Companies Customer Service Department within 5 calendar days of receipt of shipment.

1. Defective Product: Report defective product to the Hager Companies Customer Service for processing.
2. Non-Returnable Product (not all inclusive): The following Products cannot be returned to Hager Companies:
 - a. Discontinued Items
 - b. Special Order Items
 - c. Open items, and/or items needing re-packaging
 - d. Items in an unsuitable resale condition

D. Process:

All items being returned must have a Hager Companies Return Goods Authorization Number. If the return meets the Hager Companies return guidelines, you may obtain an RGA # by contacting:

Hager Companies Customer Service

Phone: 800-325-9995

E-Mail: customerconnect@hagerco.com

Warranty Returns

A credit in the amount of the original purchase order will be issued after the returned product is inspected and the defect is found to be valid.

Inspection and Delivery

Customer will inspect all product deliveries immediately upon receipt. Hager will assume acceptance of delivered product if not notified within 5 days of receipt of product.

Claims

All claims should be submitted to Hager as follows:

- All claims for pricing adjustments must be submitted within 30 days of invoice date
- All claims for order quantity discrepancies must be submitted within 5 days
- All claims for damaged material prior to acceptance by customer must be submitted within 5 days

Limited Warranty

Subject to the limitations of liability set forth below, Hager Companies (the "Company") warrants to purchasers that the products which the Company sells under the "Hager" trademark or trade name are free from defects in workmanship and materials under normal use and regular service and maintenance from date of delivery.

This is the sole and exclusive warranty given by the company with respect to the products and is in lieu of any and all other warranties, express or implied, arising by operation of law or otherwise. All implied warranties, including but not limited to the warranties of merchantability, non-infringement and fitness for a particular purpose, are hereby excluded.

This warranty does not cover defects or damage arising from improper installation, incorrect application, lack of or improper maintenance, improper storage, shipping and handling, excessive wear and tear, misuse, abuse, accident, unauthorized service, or use with unauthorized products or parts.

DISCOUNTS

Customer Number

Architectural Hinges

Residential Hinges

Roton Continuous Geared Hinges

Stainless Steel Continuous Hinges

Trim & Auxiliary

Thresholds & Weatherstripping

Sliding Door Hardware

Locks

Door Closers

Exit Devices

Electrified Products

Notes





H **HAGER**[®]
COMPANIES

TABLE OF CONTENTS

A
 Architectural Finish Symbols 3-4

B
 Back Plate 12
 Bearings 5

E
 ECCO 66-68
 Emergency Stop Release..... 14

F
 Fasteners..... 9-10

D
 Detention Food Pass Through Hinge..... 31
 Detention Hinge (IHT) 22, 28, 31
 Detention Utility Hinge..... 31

H
 Hinge Additions/Modifications 5-11
 Hinges - Electric 6-7
 Hinge Pins 8, 62
 Hinge Tips..... 11, 61-62

Hinges – Brass or Stainless Steel

BALL BEARING FIVE KNUCKLE
 Anchor 44
 Full Mortise 39-41, 61
 Half Mortise 31
 Half Surface 62
 Swing Clear 60-61
 Wide Throw 42-44, 47-48
CONCEALED BEARING THREE KNUCKLE
 Full Mortise 24, 26-27
 Wide Throw 25-28
PLAIN BEARING FIVE KNUCKLE
 Full Mortise..... 37-38
PLAIN BEARING THREE KNUCKLE
 Full Mortise 23
CONCEALED BEARING FIVE KNUCKLE
 Full Mortise..... 7
CONCEALED BEARING TWO KNUCKLE
 Full Mortise..... 30
 Drop Leaf..... 69
 Short Leaf..... 69-70
 Unequal Leaf 70

Hinges – Steel

BALL BEARING FIVE KNUCKLE
 Full Mortise 33-34, 52, 55-57
 Full Surface 63
 Half Surface 36
 Swing Clear 51-52
 Wide Throw 35-36, 58-59
CONCEALED BEARING THREE KNUCKLE
 Anchor 64-66
 Full Mortise 17-18, 20
 Swing Clear 63-64
 Wide Throw 19-22
PLAIN BEARING FIVE KNUCKLE
 Full Mortise 32, 52-54
 Full Surface 62
 Half Mortise 31
 Half Surface 36
 Swing Clear 51
 Welding 62
PLAIN BEARING THREE KNUCKLE
 Full Mortise 15-16
CONCEALED BEARING TWO KNUCKLE
 Full Mortise 29-30
PLAIN BEARING TWO KNUCKLE
 Full Mortise 29
 Drop Leaf..... 69
 Short Leaf..... 69
 Unequal Leaf 70

Hinges – Spring

Double Acting 60
 Full Mortise 48-49
 Full Mortise - Stainless Steel..... 32
 Half Surface 49
 Reverse Action..... 50
 Spring Hinge Sets..... 50

L

Lead Times 2

M

Molly Jack Nut 12
 Mortar Box..... 12



Commercial Hinges

P

Pivots.....	13-15
Pivots Rack & Pinion	14
Pivot Reinforcing	12

Q

Quick Ship	2
------------------	---

R

Reinforcement Plate	12
---------------------------	----

S

Set Screws (Set).....	12
Sleeve Bolt.....	12
Strike - Combination Rescue	13
Strike - Double Lip.....	12

T

Tip Kits.....	61-62
---------------	-------

LEAD TIMES

Stock items will typically ship in five working days or less from the order entry date. Made-to-order items will typically ship in 15 working days depending on seasonal volume and order complexity. Special orders including industrials, special machining, and large quantities may need to be scheduled. The anticipated ship date will be included with each order acknowledgement. Please contact Customer Service if product availability is in question.

QUICK SHIP

Products denoted with **red and bold** pricing are available to order through the Quick Ship program and ship within 24 hours. When ordering these products please visit www.hagerco.com and log in to MyHager to access the 'Quick Ship' portal. Due to the promptness of the fulfillment process, Quick Ship orders are non-cancellable.

CANCELLATION NOTIFICATION

Cancellation for made-to-order items must be communicated within 48 hours of order placement.

ARCHITECTURAL FINISH SYMBOLS

These additions apply to the BASE HINGE LIST PRICE as listed in the book. Not all products are available in all finishes. Contact Hager Companies Sales and Service (1-800-325-9995) for more specific information.

BHMA Symbol Base Material

*if not listed in pricing sections

US & HAGER	DESCRIPTION	PRICING INSTRUCTIONS	STEEL	BRASS & BRONZE	STAINLESS STEEL
2C	Plain Zinc Plate	20% above US10A or US10B price	603	N/A	N/A
H2H x BP	Mechanical Galvanized; Steel Only	25% above US10A price	N/A	N/A	N/A
3	Bright Brass	Use price of US10B	632	605	N/A
3A	Bright Brass - Unlacquered	Use price of US3	N/A	N/A	N/A
4	Satin Brass	Use price of US10	633	606	N/A
5	Satin Brass, Oxidized	Use price of 10A/10B	638	609	N/A
9	Bright Bronze	20% above US10A or US10B price	637	611	N/A
10	Satin Bronze	As listed	639	612	N/A
10A (US11)	Antique Bronze, Lacquered	As listed (steel only)	641/643	N/A	N/A
10B	Antique Bronze, Oiled	Use price of US10A	640	613	N/A
10Z	Antiqued Bronze-SPL	Use price of US10A/US10B	N/A	N/A	N/A
10D	Black Nickel, Oiled	Use price of US10B	640	613	N/A
SS/10Z	Antique Bronze, Stainless Steel	30% above 32D	N/A	N/A	N/A
13P	White	20% above US10			
14	Bright Nickel	20% above US10A or US10B	645	618	N/A
15	Satin Nickel	Use price of US10A or US10B	646	619	N/A
15A	Satin Nickel, Nickel Oxidized & Highlighted	20% above US10A or US10B	647	620	N/A
17A	Black Nickel, Dull	20% above US10A or US10B	648	621	N/A
26	Bright Chromium Plated	Use price of US10A or US10B	651	625	N/A
26D	Satin Chromium Plated	As listed	652	626	N/A
32	Stainless Steel Metal, Bright	Use price of US32D	N/A	N/A	629
32D	Stainless Steel Metal, Satin (304)	As listed	N/A	N/A	630
32D (316)	Stainless Steel Metal, Satin (316)	POA	N/A	N/A	630
32D (CLR)	Stainless Steel Metal, Satin (Clear Coat)	30% above US32D	N/A	N/A	630
83P	Semi Bright Black	20% above US10			
P	Prime Coat	Use price of US10	600	600	N/A
PS	Plain Steel	Use price of US4 or USP	N/A	N/A	N/A
L1	Flat Black	Use price of US10	693	693	N/A
L2 (90P)	Dark Bronze	Use price of US10	695	695	N/A
L3	Medium Bronze	Use price of US10	694	694	N/A
LS	Luma Sheen®	Use price of US10	689	689	N/A



Commercial Hinges

Whenever possible, Hager Companies employs the latest technologies in metal finishing to provide the best long-term performance for our customers. Some finishes may not comply completely with BHMA (Builders Hardware Manufacturing Association) Standard A156.18 specifications with regard to plating process. However, they match BHMA color standards and exceed all BHMA performance criteria with regard to such tests as salt spray corrosion resistance, ultraviolet light deterioration resistance, solvent resistance, perspiration resistance, and finish hardness. For the convenience of our customers, we refer to the most appropriate finish symbols to indicate similarity of appearance using BHMA standard nomenclature including the "US" and numerical designation. Dissimilar metals are plated to match or be compatible to the finishes indicated. Finish numbers indicated on each product are the most equivalent to the old "US" symbol numbers and carry the BHMA finish symbol in parenthesis adjacent to the finish: Example — US3 (605) - Bright Brass or US26D (626) - Satin Chrome.

Hager's finishes are durable, high quality finishes obtained by careful processing of steel, brass, and stainless steel materials. It is important to consider usage and climatic conditions when selecting finishes. This is especially true in areas subjected to strong corrosive chemical conditions, humid climate or salt air which may have a damaging effect on metal finishes in a very short period of time. The longevity and preservation of the finish appearance are determined by base metal and finish process.

Care and maintenance of clear protective coatings or other organic finishing applications may require different methods of cleaning and care. As an example, all hardware finishes should not be cleaned with solvents or abrasives; surfaces should periodically be cleaned with a mild, non-abrasive soap and dried lightly with a soft, clean cloth. The type of base material and finishing techniques must be considered when applying any cleaning or preservative method. Contact Hager's Sales and Service Department for further information on the care of hardware finishes.

Note: Hager only warrants US10B finish over brass or bronze base material. If steel base material is necessary, Hager recommends US10A lacquer finish.



HINGE ADDITIONS/MODIFICATIONS

These additions apply to the BASE HINGE LIST PRICE as listed in the book. They do not apply to the price of any hinges listed with additions in this book. If the hinge to be priced has additions, START WITH THE PRICE OF THE BASE HINGE, THEN ADD "FOR ADDITIONS WHERE NOT LISTED."

Antimicrobial powder coat protection - Symbol is 'MV5' (use as suffix). List price is \$23.40

Bearings

Ball bearings (symbol 'BB') and anti-friction bearings (symbol 'AB') regularly furnished. Oilite bearings (symbol 'OB') and CB (concealed bearing) available at same price as ball bearings.

*To maximize hinge life and assist in achieving ADA compliance, Hager recommends the use of anti-friction or ball bearing hinges with door closer products.



Commercial Hinges

Concealed Electric Hinge Modification

Swing clear, wide throw, raised barrel – add \$164.80; Available on Heavy weight only.

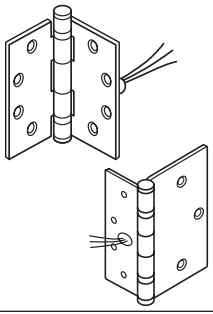
	CONCEALED ELECTRIC MONITOR		
	Description	Steel/Brass List	Stainless Steel List
	Miniature snap action switch is incorporated into the frame leaf. Available in 4" through 8". Full mortise ball bearing hinges. Concealed electric monitor, per hinge.	\$362.95	\$474.00
NRP not necessary as hinges are cross pinned and are not field removable. To order, use symbol 'EMN' as suffix.			

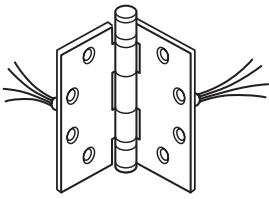
	CONCEALED ELECTRIC THROUGH-WIRE		
	Description	Steel/Brass List	Stainless Steel List
Four continuous electric conductors (28 gauge wire). Available in 4" through 8". Full mortise ball bearing, standard weight and heavy weight in steel and brass material. NRP not necessary as hinges are cross pinned and are not field removable. To order, use symbol 'ETW' as suffix.			
<u>Extra charges (each)</u>			
ETW-4 (4 wire)	\$323.50	\$404.35	
ETW-8 (8 wire)	\$358.70	\$448.40	
ETW-12 (12 wire)	\$502.10	\$627.65	
ETW-2 (18 GA)**	\$427.00	\$532.55	
ETW-6-1828 (2-18 GA, 4-28 GA)*/**	\$473.45	\$591.85	
ETW-8-1828(2-18 GA, 6-28 GA)*/**	\$523.70	\$653.50	

* Not available on three knuckle hinges. ** Not available on swing clear.

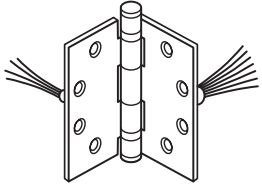

CONCEALED ELECTRIC THROUGH-WIRE & MONITOR			
Description		Steel/Brass List	Stainless Steel List
	This combines the 4, 8, or 10 continuous electrical conductors and the miniature snap action switch to provide continuous circuit and monitor capabilities. Available in 4" through 8". Full mortise ball bearing or anti-friction bearing, standard weight and heavy weight in steel and brass material. NRP not necessary as hinges are cross pinned and are not field removable. To order, use symbol 'ETM' as suffix.		
	<u>Extra charges (each)</u>		
	ETM-4 (4 wire)	\$686.40	\$858.00
	ETM-8 (8 wire)	\$718.70	\$898.40
	ETM-10 (10 wire)	\$787.60	\$984.45
\$764.66. The hospital tip feature is available on concealed electric hinges.			

STANDARD WIRE LEAD - 8" per side: 18 or 28 gauge wire
 Additional wire leads - must be bought in 4, 8, and 12 feet lengths. Price includes both sides.

Description	List
4-wire hinge; per foot	\$7.70
6-wire hinge; per foot	\$7.70
8-, 12-wire hinge; per foot	\$7.70

Quick Connect

Extra charge \$44.75 per hinge (available on ETW 4, 8, and 12 wire. Not available with 18g wire.).

QUICK CONNECT HARNESS CABLES - connectors installed on one end, pigtails on the other for easy install in the field

Part Number	Description	List Price
1-479-0007	3" Wire Harness Assembly	\$57.60
1-479-0008	6" Wire Harness Assembly	\$60.05
1-479-0012	12" Wire Harness Assembly	\$74.20
1-479-0026	26" Wire Harness Assembly	\$88.30
1-479-0032	32" Wire Harness Assembly	\$89.40
1-479-0038	38" Wire Harness Assembly	\$91.95
1-479-0044	44" Wire Harness Assembly	\$95.40
1-479-0400	50" Wire Harness Assembly	\$97.15
1-479-1500	15'2 Wire Harness Assembly	\$173.05

Five Knuckle Concealed Bearing Hinges (CB)

Available on standard weight, heavy weight full mortise 3-1/2", 4", 4-1/2", and 5". Price same as Ball Bearing (BB).



Commercial Hinges

Prices and Part Numbers for Hinge Pins (Boxes of 10 Each)

Contract Grade Pins Size 4-1/2"

STANDARD WEIGHT		
STEEL - FINISH	PART NUMBER	LIST (10/BOX)
US3	1-890-7550	\$65.40 per box
US4	1-890-7619	\$65.40 per box
US10	1-890-7695	\$65.40 per box
US10A/US10B	1-890-7733	\$65.40 per box
US26	1-890-7625	\$65.40 per box
US26D	1-890-7657	\$65.40 per box
USP	1-890-7771	\$65.40 per box
L1	1-890-7772	\$65.40 per box

HEAVY WEIGHT		
STEEL - FINISH	PART NUMBER	LIST (10/BOX)
US3	1-890-8269	\$79.95 per box
US10	1-890-8270	\$79.95 per box
US10A/US10B	1-890-8267	\$79.95 per box
US26D	1-890-8305	\$79.95 per box
USP	1-890-8268	\$79.95 per box

Non-Removable Pins (Medium Security)

Symbol	Description	List
NRP*	Set screw in barrel	\$5.00 ea.

*This modification is intended as a deterrent only. It is not to be considered suitable for high-security applications or abusive environments.

Raised Barrel Hinges

- Specify handing and door thickness.
- Not available on 8" x 6" or 8" x 8" hinges.
- Prices apply to both standard and heavyweight hinges.
- Prices listed for 1-3/8" and 1-3/4" doors only.
- For 2" or greater doors add 30%.

Symbol	Description	List
RBB	Raised Barrel for Mortised Jamb Leaf, Beveled Edge Door Leaves Equal	\$46.10 ea.
RBS	Raised Barrel for Mortised Jamb Leaf, Square Edge Door Leaves Equal	\$46.10 ea.
ISM	Raised Barrel for Jamb Surface Mount, Leaves Equal	\$46.10 ea.



Clear Coat

Not available on all finishes.

<u>Symbol</u>	<u>List</u>
CLR	Add 30% to list price of hinge

Round Corners

Round corners (1/4" and 5/8" radius). Specify radius desired; standard radius 1/4".

<u>Symbol</u>	<u>List</u>
RC	\$8.25 ea.

Safety Stud

Security offered to prevent slipping leaves past one another when hinge is closed. Stud attached to one leaf projects into hole in matching leaf.

<u>Symbol</u>	<u>List</u>
SH*	\$19.65 ea.

This feature not necessary on anchor hinges

* This modification is intended as a deterrent only. It is not to be considered suitable for high-security applications or abusive environments.

Reverse Safety Stud - Heavy Weight Only

Reverse safety studs extend into reinforcing plate of door & frame to help prevent screw shearing.

<u>Symbol</u>	<u>List</u>
RSS	\$30.30 ea.

Note: Available on steel, stainless steel detention or institutional tip hinges only. Not available on solid brass hinges.

Special Applications

In the event you do not find the particular hinge which will meet your requirements, we recommend that you contact Hager Companies Sales and Service and provide us with your specification.

Special Screws

All butt hinges are regularly packed with flat Phillips head wood or machine screws or bolts. All other types are special.

Extra for tamper proof torx screws

<u>Description</u>	<u>List</u>
Steel	\$1.55 per screw \$12.40 hinge
Stainless steel	\$2.05 per screw \$16.10 hinge

Boxed Screws

Machine Torx (12-24 x1/2 - for 4", 4.5", 5" hinges)

<u>Description</u>	<u>List</u>
1-804-3212 (26D)	\$154.50 per box-torx (100/box)
1-803-3205 (32D)	\$180.25 per box-torx (100/box)

Wood Torx (1-1/4x12 - for 4", 4.5", 5" hinges)

<u>Description</u>	<u>List</u>
1-810-9920 (26D)	\$154.50 per box-torx (100/box)
1-813-9910 (32D)	\$180.25 per box-torx (100/box)



Commercial Hinges

Standard Screw Packs for Full Mortise Architectural Hinges

PART NUMBER	SIZE	FINISH	SCREWS
700, AB700, 1279, BB1279, EC1100, EC1105, 1250 (with or without NRP), ECBB1100	4-1/2" x 4-1/2" 4-1/2" x 4	US3, US4, US5, US10, US10A (US11), US10B, US15, US15A, US26, US26D, USP	AMS & AWS
Other than listed above	4-1/2"	Other than listed above	AMS & 1/2 WS
All	3-1/2"	All	AWS & 1/2 MS
All	4"	All	AWS & 1/2 MS
All	5"	All	AMS & 1/2 WS
All hinges with decorative tips	All	All	AWS

Note: Hinge additions listed on pages 5-9 will affect standard screw packaging.

Prices and Part Numbers for Bulk Packed Screws Contract grade hinges size 4", 4-1/2", and 5"

WOOD SCREWS 1-1/4" x 12 FPHW - STEEL			MACHINE SCREWS 12-24 x 1/2" FPHM - STEEL		
PART NUMBER	FINISH	LIST (100/BOX)	PART NUMBER	FINISH	LIST (100/BOX)
1-810-5824	US3	\$112.10 per box	1-800-7225	US3	\$55.85 per box
1-810-5952	US4	\$112.10 per box	1-810-7275	US4	\$55.85 per box
1-810-6208	US10	\$112.10 per box	1-800-7375	US10	\$55.85 per box
1-810-6336	US10A/US10B	\$112.10 per box	1-800-7425	US10A (US11)/US10B	\$55.85 per box
1-810-6848	US26	\$112.10 per box	1-800-7575	US26	\$55.85 per box
1-810-5696	US26D	\$112.10 per box	1-800-7175	US26D	\$55.85 per box
1-810-6976	USP	\$112.10 per box	1-800-7625	USP	\$55.85 per box
1-810-7232	L1	\$112.10 per box	1-800-7725	L1	\$55.85 per box

WOOD SCREWS 1-1/4" x 12 FPHW - BRASS			MACHINE SCREWS 12-24 x 1/2" FPHM - BRASS		
PART NUMBER	FINISH	LIST (100/BOX)	PART NUMBER	FINISH	LIST (100/BOX)
1-811-5824	US3	\$222.30 per box	1-801-7225	US3	\$111.30 per box
1-811-5952	US4	\$222.30 per box	1-801-7275	US4	\$111.30 per box
1-811-6208	US10	\$222.30 per box	1-801-7375	US10	\$111.30 per box
1-811-6336	US10A/US10B	\$222.30 per box	1-801-7425	US10A (US11)/US10B	\$111.30 per box
1-811-6848	US26	\$222.30 per box	1-801-7575	US26	\$111.30 per box
1-811-5696	US26D	\$222.30 per box	1-801-7175	US26D	\$111.30 per box
1-811-6976	USP	\$222.30 per box	1-801-7625	USP	\$111.30 per box
1-811-7232	L1	\$223.30 per box	1-801-7725	L1	\$111.30 per box

WOOD SCREWS 1-1/4" x 12 FPHW - STAINLESS STEEL			MACHINE SCREWS 12-24 x 1/2" FPHM - STAINLESS STEEL		
PART NUMBER	FINISH	LIST (100/BOX)	PART NUMBER	FINISH	LIST (100/BOX)
1-813-2500	US32	\$222.30 per box	1-803-2500	US32	\$111.30 per box
1-813-2499	US32D	\$222.30 per box	1-803-2499	US32D	\$111.30 per box

Stainless Steel Balls and Raceways

Furnished if desired on steel or brass ball bearing hinges.

<u>Description</u>	<u>List</u>
Standard weight two ball bearing hinge	\$24.10 ea.
Heavy weight four ball bearing hinge	\$29.10ea.

Swaging

Swaging, no holes or flat surface, add 30% to list price of hinge.

Tips - Exposed

<u>Symbol</u>	<u>Description</u>	<u>List</u>
ET*	Button tip for three knuckle hinges only.....	N/C
*Exposed Tip	(ET standard on 5 knuckle)	





Tips - Hospital

<u>Symbol</u>	<u>Description</u>	<u>List</u>
HT*	Standard Weight and Heavy Weight Hinges.....	\$31.05
*Hospital Tip		

Tips - Decorator

Regular decorator tips are available on brass or steel hinges, three and five knuckle, for the type and size shown below. To order hinges with regular decorator tips, give the catalog number of the hinge, the size, the finish and the tip style.

Regular Decorator Tips:
 For example: BB1199 – 5" x 5" US3 Ball Tip
 BB1279 – 4-1/2" x 4-1/2" US10A Steeple Tip
 AB700 – 4-1/2" x 4-1/2" US3 Ball Tip

REGULAR DECORATOR TIPS (Supplied with all wood screws unless otherwise specified)			LIST
Acorn Tip		Standard Weight - 3-1/2", 4", 4-1/2", 5", and 6" Heavy Weight - 4-1/2", 5", 6", and 8"	\$48.40 \$48.40
Ball Tip		Standard Weight - 3", 3-1/2", 4", 4-1/2", 5", and 6" Heavy Weight - 4-1/2", 5", 6", and 8"	\$30.30 \$30.30
Steeple Tip		Standard Weight - 3", 3-1/2", 4", 4-1/2", 5", and 6" Heavy Weight - 4-1/2", 5", 6", and 8"	\$30.30 \$30.30
Urn Tip		Standard Weight - 3-1/2", 4", 4-1/2", 5", and 6" Heavy Weight - 4-1/2", 5", 6", and 8"	\$48.40 \$48.40

Note: Certain hinge additions/modifications may not be applicable. Please contact Hager Companies Customer Service before ordering.

Commercial Hinges

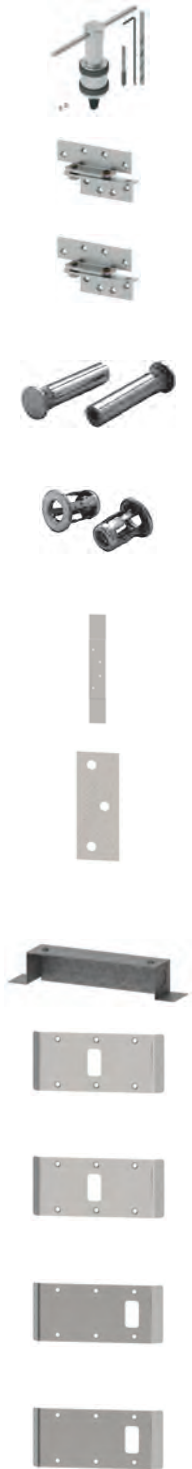

Description		Finish	2021 List	Stock No.	Box Qty.	Case Qty.
100 Set Screw Set		PS	370.90	001076		10
252 Full Surface Reinforcing Pivot for 4" (102 mm) wide hinges, non-handed.		US2C	193.95	121579		10
253 Full Surface Reinforcing Pivot for 4-1/2" (114 mm) wide hinges, non-handed.		US2C	193.95	121571	1	
263 Thru Bolts for reinforcing 1-3/4" (45 mm) doors. Pack of 100		US2C	264.80	001141	1 pack	
265 Molly Jack Nuts (8S JN) for Reinforcing Pivot Pack of 100		US2C	141.15	001143	1 pack of 100	
305 Hinge Reinforcement Plate	4-1/2" (114 mm)	PS	8.85	001153		50
417 Back Plate for Wood Doors Half Surface Hinges or Full Surface Hinges	4-5/8" (117 mm)	USP	31.90	001195	10	100
		US10	31.90	001187		
		US26D	31.90	001190		
	5" (127 mm)	USP	33.85	001203	10	100
		US10	33.85	-		
		US26D	33.85	001199		
430 Mortar Box		H2H	64.55	001206	1	
451 Double Lipped Strike Center Hung <i>*Other sizes available</i>	5-3/4" (146 mm)	US26D	204.05	001208	1	
452 Double Lipped Strike Center Hung <i>*Other sizes available</i>	6-3/4" (172 mm)	US26D	204.05	001209	1	
453 Double Lipped Strike 1/8" Inset <i>*Other sizes available</i>	5-3/4 (146 mm)	US26D	204.05	001210	1	
454 Double Lipped Strike 1/8" Inset <i>*Other sizes available</i>	6-3/4" (172 mm)	US26D	204.05	001211	1	

	Description	Finish	2021 List	Stock No.	Box Qty.	Case Qty.
	455 Center Hung Combination Rescue Door Stop and Two Way Strike Plates Specify Handing *Other sizes available	5-3/4	LH US26D 583.15	001218	1	
		(146 mm)	RH US26D 583.15	001219		
	456 Center Hung Combination Rescue Door Stop and Two Way Strike Plates Specify Handing *Other sizes available	6-3/4"	LH US26D 588.00	001222	1	
		(172 mm)	RH US26D 588.00	001223		
	457 1/8" Inset Combination Rescue Door Stop and Two Way Strike Plates Specify Handing *Other sizes available	5-3/4	LH US26D 583.15	001224	1	
		(146 mm)	RH US26D 583.15	001225		
	458 1/8" Inset Combination Rescue Door Stop and Two Way Strike Plates Specify Handing *Other sizes available	6-3/4"	LH US26D 612.25	001226	1	
		(172 mm)	RH US26D 612.25	001227		
	*Other sizes available	4 3/4" thru 8 3/4" greater than 8 3/4"		add \$82.40 to list of 6 3/4" size add \$128.75 to list of 6 3/4" size		
	495 Forged Bronze - Full Mortise Ball Bearing Adjustable Top Pivot Hinge		US26D 254.05	001236	1	
	496 Forged Bronze - Full Mortise Ball Bearing Adjustable Intermediate Pivot Hinge Specify Handing		LH US26D 342.30	001250	1	
			RH US26D 342.30	001251		
	497 Forged Bronze - Full Mortise Ball Bearing Adjustable Bottom Pivot Hinge Specify Handing		LH US26D 576.15	001265	1	
			RH US26D 576.15	001266		
	500 Brass - Full Mortise Standard Weight Rack and Pinion Pivot		US26D 534.60	001274	1	16

1. Items with the price in **bold and red** are Quick Ship items and ship in 24 hours.
Please use stock number when ordering. 2. U/M is each unless otherwise noted.



Commercial Hinges



Description	Finish	2021 List	Stock No.	Box Qty.	Case Qty.
510 Mortise Application - Hospital Set Wood Floor - Less Release	US26D	360.60	001278	1	10
511 Mortise Application - Hospital Set Masonry Floor - Less Release	US26D	430.00	001281	1	10
512 Surface Application - Hospital Set Masonry Floor - Less Release	US26D	430.00	001283	1	10
550 Brass - Full Mortise Heavy Weight Rack and Pinion Pivot	US26D	641.45	001288	1	10
551 Brass - Full Mortise Extra Heavy Weight Rack and Pinion Pivot	US26D	704.30	113311	1	10
610 Emergency Stop Release	US26D	277.00	001296	1	10
611 Mortise Application - Hospital Set Masonry Floor	US26D	712.75	001298	1	10
612 Surface Application - Hospital Set Masonry Floor	US26D	712.75	001301	1	10

1. Items with the price in **bold and red** are Quick Ship items and ship in 24 hours.
Please use stock number when ordering. 2. U/M is each unless otherwise noted.



Description	Finish	2021 List	Stock No.	Box Qty.	Case Qty.
615 Steel - Heavy Weight Pivot Set for Frameless Opening	US26D	152.60	042688	1	10
700 Steel - Full Mortise Standard Weight Plain Bearing Three Knuckle	3-1/2" x 3-1/2" (89 mm x 89 mm)	LS 12.30 USP 9.15 US3 18.30 US4 12.30 US10 12.30 US10A (US11) 18.30 US10B 18.30 US26 18.30 US26D 15.30	- 000926 001311 001312 001303 001304 069448 001308 001309	2	100
	4" x 4" (102 mm x 102 mm)	LS 14.50 USP 11.25 US3 20.75 US4 14.50 US10 14.50 US10A (US11) 20.75 US10B 20.75 US26 20.75 US26D 18.70	- 001326 001323 005175 001317 001318 046652 001320 001321	3	48
	4-1/2" x 4" (114 mm x 102 mm)	LS 13.85 USP 11.85 US3 23.70 US4 13.85 US10 13.85 US10A (US11) 23.70 US10B 23.70 US26 23.70 US26D 15.05	085393 001350 001343 001344 001328 001329 001332 001336 001340	3	48

1. Items with the price in **bold and red** are Quick Ship items and ship in 24 hours.
Please use stock number when ordering. 2. U/M is each unless otherwise noted.



Commercial Hinges



Description	Finish	2021 List	Stock No.	Box Qty.	Case Qty.	
700 - Cont. Continued	4-1/2" x 4-1/2" (114 mm x 114 mm)	LS	13.85	-	3	48
		USP	11.85	001390		
		US3	23.70	001372		
		US4	13.85	001376		
		US10	13.85	001352		
		US10A (US11)	23.70	001355		
		US10B	23.70	001360		
		US26	23.70	001364		
		US26D	15.05	001367		
	5" x 4" (127 mm x 102 mm)	LS	47.65	-	3	24
USP		39.20	001399			
US3		64.40	-			
US4		47.65	-			
US10		47.65	-			
US10A (US11)		64.40	-			
US10B		64.40	109332			
US26		64.40	-			
US26D		44.15	104223			
5" x 4-1/2" (127 mm x 114 mm)	LS	47.65	-	3	24	
	USP	39.20	067157			
	US3	64.40	-			
	US4	47.65	-			
	US10	47.65	038706			
	US10A (US11)	64.40	-			
	US10B	64.40	-			
	US26	64.40	065399			
	US26D	44.15	001403			
5" x 5" (127 mm x 127 mm)	LS	47.65	-	3	24	
	USP	39.20	042507			
	US3	64.40	-			
	US4	47.65	-			
	US10	47.65	041251			
	US10A (US11)	64.40	115621			
	US10B	64.40	038084			
	US26	64.40	-			
	US26D	44.15	068632			





Description	Finish	2021 List	Stock No.	Box Qty.	Case Qty.	
AB700 Steel - Full Mortise Standard Weight Concealed Anti-Friction Bearing Three Knuckle	3-1/2" x 3-1/2" (89 mm x 89 mm)	LS	36.55	124088	2	100
		USP	32.05	045449		
		US3	44.30	044765		
		US4	32.05	016859		
		US10	36.65	029909		
		US10A (US11)	44.30	012038		
		US10B	44.30	033999		
		US26	44.30	053130		
		US26D	38.05	091472		
	4" x 4" (102 mm x 102 mm)	LS	36.65	-	3	48
		USP	32.05	001501		
		US3	44.30	001497		
US4		32.05	001499			
US10		36.65	098013			
US10A (US11)		44.30	068298			
US10B		44.30	034156			
US26		44.30	022969			
	US26D	38.05	001495			

1. Items with the price in **bold and red** are Quick Ship items and ship in 24 hours.
Please use stock number when ordering. 2. U/M is each unless otherwise noted.



Commercial Hinges



Description	Finish	2021 List	Stock No.	Box Qty.	Case Qty.	
AB700 - Cont. Continued	4-1/2" x 4" (114 mm x 102 mm)	LS	30.55	085392	3	48
		USP	21.55	001559		
		US3	36.90	001543		
		US4	30.55	095580		
		US10	30.55	001502		
		US10A (US11)	36.90	001507		
		US10B	36.90	001515		
		US26	36.90	001526		
		US26D	20.75	001533		
	4-1/2" x 4-1/2" (114 mm x 114 mm)	LS	30.55	122473	3	48
USP		21.55	001682			
US3		36.90	001645			
US4		30.55	001654			
US10		30.55	001574			
US10A (US11)		36.90	001585			
US10B		36.90	001597			
US26		36.90	001607			
US26D		20.75	001620			
5" x 4" (127 mm x 102 mm)		LS	59.65	-	3	24
	USP	59.65	069644			
	US3	75.50	046335			
	US4	59.65	017201			
	US10	59.65	047777			
	US10A (US11)	75.50	033653			
	US10B	75.50	047266			
	US26	75.50	001706			
	US26D	58.35	001709			
	5" x 4-1/2" (127 mm x 114 mm)	LS	59.65	-	3	24
USP		59.65	001748			
US3		75.50	001738			
US4		59.65	091318			
US10		59.65	098518			
US10A (US11)		75.50	097200			
US10B		75.50	028451			
US26		75.50	019133			
US26D		58.35	001727			
5" x 5" (127 mm x 127 mm)		LS	59.65	-	3	24
	USP	59.65	001773			
	US3	75.50	020279			
	US4	59.65	017173			
	US10	59.65	001758			
	US10A (US11)	75.50	008276			
	US10B	75.50	048588			
	US26	75.50	016080			
	US26D	58.35	025276			





Description	Finish	2021 List	Stock No.	Box Qty.	Case Qty.
WTAB700 Wide Throw Hinge Steel - Full Mortise Standard Weight Concealed Anti-Friction Bearing Three Knuckle	4-1/2" x 5" (114 mm x 127 mm)	LS	114.95	-	3 24
		USP	112.45	065577	
		US3	128.75	069940	
		US10	114.95	043251	
		US10A (US11)	128.75	030958	
		US10B	128.75	007941	
		US26	128.75	069304	
		US26D	120.50	001446	
	4-1/2" x 6" (114 mm x 152 mm)	LS	114.95	-	3 24
		USP	112.45	023667	
US3		128.75	026730		
US10		114.95	065978		
US10A (US11)		128.75	065835		
US10B		128.75	075797		
US26		128.75	062172		
US26D		120.50	001458		
4-1/2" x 7" (114 mm x 178 mm)	LS	124.00	-	3 24	
	USP	124.00	032001		
	US3	141.40	-		
	US10	126.35	091490		
	US10A (US11)	141.40	047357		
	US10B	141.40	104122		
	US26	141.40	001467		
	US26D	132.45	039039		
4-1/2" x 8" (114 mm x 203 mm)	LS	124.00	-	3 24	
	USP	124.00	046359		
	US3	141.40	011806		
	US10	126.35	-		
	US10A (US11)	141.40	063050		
	US10B	141.40	104121		
	US26	141.40	081758		
	US26D	132.45	001469		
5" x 6" (127 mm x 152 mm)	LS	164.70	-	3 24	
	USP	156.80	110219		
	US3	196.00	054746		
	US10	164.70	077240		
	US10A (US11)	196.00	-		
	US10B	196.00	030049		
	US26	196.00	-		
	US26D	180.35	047936		
5" x 7" (127 mm x 178 mm)	LS	164.70	-	3 24	
	USP	156.80	134948		
	US3	196.00	-		
	US10	164.70	-		
	US10A (US11)	196.00	044063		
	US10B	196.00	045970		
	US26	196.00	-		
	US26D	180.35	088534		

1. Items with the price in **bold and red** are Quick Ship items and ship in 24 hours.
Please use stock number when ordering. 2. U/M is each unless otherwise noted.



Commercial Hinges



Description	Finish	2021 List	Stock No.	Box Qty.	Case Qty.	
WTAB700 - Cont. Continued	5" x 8" (127 mm x 203 mm)	LS	164.70	-	3	24
		USP	156.80	-		
		US3	196.00	-		
		US10	164.70	-		
		US10A (US11)	196.00	085769		
		US10B	196.00	104124		
		US26	196.00	-		
		US26D	180.35	040817		
AB750 Steel - Full Mortise Heavy Weight Concealed Anti-Friction Bearing Three Knuckle	4-1/2" x 4" (114 mm x 102 mm)	LS	66.90	-	3	24
		USP	66.90	096935		
		US3	79.40	073827		
		US4	66.90	071658		
		US10	66.90	001909		
		US10A (US11)	79.40	001911		
		US10B	79.40	065832		
		US26	79.40	001914		
	US26D	57.25	092641			
	4-1/2" x 4-1/2" (114 mm x 114 mm)	LS	66.90	114475	3	24
		USP	66.90	002006		
		US3	79.40	001982		
		US4	66.90	001987		
		US10	66.90	001936		
		US10A (US11)	79.40	001944		
		US10B	79.40	001956		
US26		79.40	001965			
US26D	57.25	001970				
5" x 4-1/2" (127 mm x 114 mm)	LS	86.05	-	3	24	
	USP	86.05	002093			
	US3	89.60	002078			
	US4	86.05	002081			
	US10	86.05	092589			
	US10A (US11)	89.60	002044			
	US10B	89.60	002055			
	US26	89.60	016351			
US26D	73.75	002064				
5" x 5" (127 mm x 127 mm)	LS	86.05	-	3	24	
	USP	86.05	023577			
	US3	89.60	030368			
	US4	86.05	002131			
	US10	86.05	002109			
	US10A (US11)	89.60	002113			
	US10B	89.60	017886			
	US26	89.60	006052			
US26D	73.75	002125				





Description	Finish	2021 List	Stock No.	Box Qty.	Case Qty.
WTAB750					
Wide Throw	4-1/2" x 5"	LS	166.15	-	3 24
Steel - Full Mortise	(114 x 127 mm)	USP	180.15	115754	
Heavy Weight		US3	202.50	-	
Concealed Anti-Friction Bearing		US10	166.15	065696	
Three Knuckle		US10A (US11)	202.50	093406	
		US10B	202.50	076857	
		US26	202.50	092976	
		US26D	167.20	022959	
<hr/>					
	4-1/2" x 6"	LS	166.95	-	3 24
	(114 mm x 152 mm)	USP	180.95	063855	
		US3	203.55	043920	
		US10	166.95	045850	
		US10A (US11)	203.55	090251	
		US10B	203.55	086471	
		US26	203.55	089046	
		US26D	174.70	097881	
<hr/>					
	4-1/2" x 7"	LS	224.55	-	3 24
	(114 mm x 178 mm)	USP	243.60	-	
		US3	274.10	-	
		US10	224.55	071083	
		US10A (US11)	274.10	100602	
		US10B	274.10	008253	
		US26	274.10	-	
		US26D	235.15	067308	
<hr/>					
	4-1/2" x 8"	LS	230.00	-	3 24
	(114 mm x 203 mm)	USP	249.25	130101	
		US3	280.40	116852	
		US10	230.00	-	
		US10A (US11)	280.40	-	
		US10B	280.40	106119	
		US26	280.40	-	
		US26D	240.70	003472	

1. Items with the price in **bold and red** are Quick Ship items and ship in 24 hours.
 Please use stock number when ordering. 2. U/M is each unless otherwise noted.



Commercial Hinges



Description	Finish	2021 List	Stock No.	Box Qty.	Case Qty.
WTAB750 - Cont.	5" x 6"	LS	224.30	-	3 24
Continued	(127 mm x 152 mm)	USP	243.00	082907	
		US3	272.05	010751	
		US10	224.30	021555	
		US10A (US11)	272.05	010915	
		US10B	272.05	099390	
		US26	272.05	-	
		US26D	232.60	001905	
	5" x 7"	LS	227.70	-	3 24
	(127 mm x 178 mm)	USP	246.60	082905	
		US3	227.70	055700	
		US10	275.95	107846	
		US10A (US11)	275.95	-	
		US10B	275.95	141294	
		US26	275.95	-	
		US26D	236.00	045843	
	5" x 8"	LS	237.55	-	3 24
	(127 mm x 203 mm)	USP	257.25	069579	
		US3	288.15	-	
		US10	237.55	-	
		US10A (US11)	288.15	109588	
		US10B	288.15	000774	
		US26	288.15	-	
		US26D	246.10	020835	
IHTAB750	4-1/2" x 4-1/2"	LS	118.75	082386	3 24
MADE IN USA	(114 mm x 114 mm)	USP	140.20	081222	
Steel - Full Mortise		US26D	124.35	081223	
Concealed Anti-Friction Bearing	5" x 4-1/2"	LS	129.90	-	3 24
Heavy Weight	(127 x 114 mm)	USP	149.00	005416	
Institutional or Prison;		US26D	136.30	089127	
Welded Hospital Tip					
Three Knuckle					
TORX Screws - add \$12 to list					





Description	Finish	2021 List	Stock No.	Box Qty.	Case Qty.	
300 Brass or Stainless Full Mortise Standard Weight Plain Bearing Three Knuckle	3-1/2" x 3-1/2" (89 mm x 89 mm)	US3	89.10	002239	2	100
		US10	69.80	125628		
		US10B	89.10	002236		
		US26	89.10	018814		
		US26D	79.80	017876		
		US32D	84.20	002240		
4" x 4" (102 mm x 102 mm)		US3	86.10	002247	3	48
		US10	66.70	-		
		US10B	85.90	013109		
		US26	85.90	032743		
		US26D	79.20	002246		
		US32D	91.30	002249		
4-1/2" x 4" (114 mm x 102 mm)		US3	77.05	024497	3	48
		US10	65.80	-		
		US10B	77.05	023835		
		US26	77.05	-		
		US26D	69.60	032689		
		US32D	78.75	071727		
4-1/2" x 4-1/2" (114 mm x 114 mm)		US3	77.05	002279	3	48
		US10	65.80	005530		
		US10B	77.05	002268		
		US26	77.05	002271		
		US26D	69.60	002274		
		US32D	78.75	002284		
5" x 4" (127 mm x 102 mm)		US3	121.60	-	3	24
		US10	97.10	-		
		US10B	121.60	061899		
		US26	121.60	-		
		US26D	108.05	092717		
		US32D	123.05	097552		
5" x 4-1/2" (127 x 114 mm)		US3	121.60	019910	3	24
		US10	97.10	-		
		US10B	121.60	067358		
		US26	121.60	-		
		US26D	108.05	107933		
		US32D	123.05	006935		
5" x 5" (127 mm x 127 mm)		US3	121.60	016629	3	24
		US10	97.10	-		
		US10B	121.60	126436		
		US26	121.60	103826		
		US26D	108.05	085018		
		US32D	123.05	019417		

1. Items with the price in **bold and red** are Quick Ship items and ship in 24 hours.
Please use stock number when ordering. 2. U/M is each unless otherwise noted.



Commercial Hinges



Description	Finish	2021 List	Stock No.	Box Qty.	Case Qty.	
AB800 Brass or stainless Full Mortise Standard Weight Concealed Anti-Friction Bearing Three Knuckle	4-1/2" x 4" (114 mm x 102 mm)	US3	88.30	002371	3	48
		US10	73.40	002353		
		US10B	88.30	002354		
		US26	88.30	031110		
		US26D	75.00	002366		
		US32D	76.15	002379		
4-1/2" x 4-1/2" (114 mm x 114 mm)		US3	88.30	002430	3	48
		US10	73.40	002390		
		US10B	88.30	002397		
		US26	88.30	095263		
		US26D	75.00	002416		
		US32D	76.15	002441		
5" x 4" (127 mm x 102 mm)		US3	145.30	138239	3	24
		US10	113.15	014350		
		US10B	145.30	053030		
		US26	145.30	174125		
		US26D	115.80	041703		
		US32D	119.10	002477		
5" x 4-1/2" (127 mm x 114 mm)		US3	145.30	-	3	24
		US10	113.15	178861		
		US10B	145.30	037911		
		US26	145.30	187217		
		US26D	115.80	096274		
		US32D	119.10	002500		
5" x 5" (127 mm x 127 mm)		US3	145.30	032238	3	24
		US10	113.15	129222		
		US10B	145.30	021424		
		US26	145.30	065762		
		US26D	115.80	009938		
		US32D	119.10	095163		





Description	Finish	2021 List	Stock No.	Box Qty.	Case Qty.
WTAB800					
Wide Throw	4-1/2" x 5" (114 mm x 127 mm)	LS 168.50	-	3	24
Brass or Stainless	US3 235.50	051926			
Full Mortise	US10 168.50	074633			
Standard Weight	US10B 222.50	002306			
Concealed Anti-Friction Bearing	US26 222.50	-			
Three Knuckle	US26D 191.10	081811			
	US32 235.50	-			
	US32D 235.50	022382			
<hr/>					
	4-1/2" x 6" (114 mm x 152 mm)	LS 184.60	-	3	24
	US3 240.45	016264			
	US10 184.60	-			
	US10B 240.45	047131			
	US26 240.45	-			
	US26D 190.65	015281			
	US32 253.10	065657			
	US32D 253.10	078170			
<hr/>					
	4-1/2" x 7" (114 mm x 178 mm)	LS 193.90	-	3	24
	US3 252.60	121348			
	US10 193.90	-			
	US10B 252.60	021385			
	US26 252.60	-			
	US26D 228.75	121347			
	US32 265.80	-			
	US32D 265.80	017222			
<hr/>					
	4-1/2" x 8" (114 mm x 203 mm)	LS 196.30	-	3	24
	US3 252.85	-			
	US10 196.30	-			
	US10B 252.85	-			
	US26 252.85	-			
	US26D 220.65	037781			
	US32 265.55	048269			
	US32D 265.55	113887			
<hr/>					
	5" x 6" (127 mm x 152 mm)	LS 358.00	-	3	24
	US3 468.85	-			
	US10 358.00	-			
	US10B 468.85	043722			
	US26 468.85	055820			
	US26D 414.30	122338			
	US32 497.60	-			
	US32D 497.60	045622			
<hr/>					
	5" x 7" (127 mm x 178 mm)	LS 375.85	-	3	24
	US3 492.40	-			
	US10 375.85	140083			
	US10B 492.40	-			
	US26 492.40	-			
	US26D 427.00	154976			
	US32 521.75	-			
	US32D 521.75	140540			

1. Items with the price in **bold and red** are Quick Ship items and ship in 24 hours.
Please use stock number when ordering. 2. U/M is each unless otherwise noted.



Commercial Hinges



Description	Finish	2021 List	Stock No.	Box Qty.	Case Qty.	
WTAB800 - Cont.	5" x 8"	LS	415.05	-	3	24
Continued	(127 mm x 203 mm)	US3	512.50	-		
		US10	415.05	-		
		US10B	512.50	-		
		US26	512.50	-		
		US26D	447.75	-		
		US32	535.00	-		
		US32D	535.00	088291		
AB850	4-1/2" x 4"	US3	136.30	046338	3	24
Brass or Stainless	(114 mm x 102 mm)	US10	125.75	045488		
Full Mortise		US10B	136.30	001714		
Heavy Weight		US26	136.30	156069		
Concealed Anti-Friction Bearing		US26D	107.95	002599		
Three Knuckle		US32D	110.15	093039		
	4-1/2" x 4-1/2"	US3	136.30	098711	3	24
	(114 mm x 114 mm)	US10	125.75	002615		
		US10B	136.30	094812		
		US26	136.30	002631		
		US26D	107.95	002638		
		US32D	110.15	002654		
	5" x 4"	US3	173.95	153153	3	24
	(127 mm x 102 mm)	US10	146.45	014351		
		US10B	173.95	100720		
		US26	173.95	081818		
		US26D	146.50	057422		
		US32D	149.10	002683		



Description	Finish	2021 List	Stock No.	Box Qty.	Case Qty.	
AB850 - Cont. Continued	5" x 4-1/2" (127 mm x 114 mm)	US3	173.95	091548	3	24
		US10	146.45	008334		
		US10B	173.95	002691		
		US26	173.95	002700		
		US26D	146.50	002704		
		US32D	149.10	002721		
5" x 5" (127 mm x 127 mm)	US3	173.95	032239	3	24	
	US10	146.45	033916			
	US10B	173.95	095231			
	US26	173.95	112488			
	US26D	146.50	002743			
	US32D	149.10	024905			
6" x 4-1/2" (152 mm x 114 mm)	US3	404.80	072875	3	24	
	US10	263.00	025004			
	US10B	404.80	043245			
	US26	404.80	-			
	US26D	285.45	074191			
	US32D	386.10	002758			
6" x 5" (152 mm x 127 mm)	US3	404.80	187952	3	24	
	US10	263.00	-			
	US10B	404.80	034166			
	US26	404.80	-			
	US26D	285.45	022892			
	US32D	386.10	001925			
6" x 6" (152 mm x 152 mm)	US26D	285.45	026100	3	24	
	US32D	386.10	002771			
WTAB850 Wide Throw Brass or Stainless Full Mortise Heavy Weight Concealed Anti-Friction Bearing Three Knuckle	4-1/2" x 5" (114 mm x 127 mm)	LS	252.30	-	3	24
		US3	319.70	119032		
		US10	252.30	089830		
		US10B	319.70	041693		
		US26	319.70	-		
		US26D	277.20	014202		
4-1/2" x 6" (114 mm x 152 mm)	LS	261.05	-	3	24	
	US3	329.05	119033			
	US10	261.05	163644			
	US10B	329.05	030057			
	US26	329.05	-			
	US26D	295.80	004168			
4-1/2" x 7" (114 mm x 178 mm)	LS	289.15	-	3	24	
	US3	347.50	-			
	US10	289.15	-			
	US10B	347.50	062830			
	US26	347.50	-			
	US26D	333.65	147246			
	US32	375.30	-			
	US32D	375.30	-			



1. Items with the price in **bold and red** are Quick Ship items and ship in 24 hours.
Please use stock number when ordering. 2. U/M is each unless otherwise noted.



Commercial Hinges



Description	Finish	2021 List	Stock No.	Box Qty.	Case Qty.	
WTAB850 - Cont. Continued	4-1/2" x 8" (114 mm x 203 mm)	LS	319.75	-	3	24
		US3	375.30	-		
		US10	319.75	-		
		US10B	375.30	113225		
		US26	375.30	-		
		US26D	347.50	025417		
		US32	405.90	-		
		US32D	405.90	035073		
5" x 6" (127 mm x 152 mm)	LS	333.65	095930	3	24	
	US3	389.20	158474			
	US10	333.65	125209			
	US10B	389.20	011469			
	US26	389.20	-			
	US26D	358.65	-			
	US32	433.70	099689			
	US32D	433.70	045352			
5" x 7" (127 mm x 178 mm)	LS	333.65	-	3	24	
	US3	403.15	-			
	US10	333.65	-			
	US10B	403.15	104539			
	US26	403.15	-			
	US26D	361.35	-			
	US32	439.25	-			
	US32D	439.25	081554			
5" x 8" (127 mm x 203 mm)	LS	358.65	-	3	24	
	US3	419.80	106302			
	US10	358.65	-			
	US10B	419.80	019906			
	US26	419.80	-			
	US26D	375.30	-			
	US32	458.70	133633			
	US32D	458.70	015599			
IHTAB850 MADE IN USA Stainless - Full Mortise Heavy Weight Concealed Anti-Friction Bearing Institutional or Prison Welded Hospital Tip Three Knuckle TORX Screws - add \$16.50 to list	4-1/2" x 4-1/2" (114 x 114 mm)	US32D	200.05	079272	3	24
	5" x 4-1/2" (127 mm x 114 mm)	US32D	252.60	095240	3	24





Description	Finish	2021 List	Stock No.	Box Qty.	Case Qty.	
920 Steel Full Mortise Standard Weight Plain Bearing Two Knuckle Specify Handing	4-1/2" x 4" (114 mm x 102 mm)	LH USP	12.15	002850	3 48	
		RH USP	12.15	002851		
		LH US10	16.75	002828		
		RH US10	16.75	002830		
		LH US10A (US11)	32.45	074625		
		RH US10A (US11)	32.45	002833		
		LH US10B	32.45	073260		
		RH US10B	32.45	073258		
		LH US26D	23.25	002836		
		RH US26D	23.25	002837		
	4-1/2" x 4-1/2" (114 mm x 114 mm)	LH USP	13.40	002888		3 48
		RH USP	13.40	002889		
		LH US10	16.75	002852		
		RH US10	16.75	002853		
LH US10A (US11)		32.45	002854			
RH US10A (US11)		32.45	002856			
LHUS10B		32.45	002858			
RH US10B		32.45	002859			
LH US26D		23.70	002867			
RH US26D		23.70	002869			
AB920 Steel Full Mortise Standard Weight Concealed Anti-Friction Bearing Two Knuckle Specify Handing	4-1/2" x 4" (114 mm x 102 mm)	LH USP	33.45	002914	3 48	
		RH USP	33.45	002915		
		LH US10	29.05	002890		
		RH US10	29.05	002892		
		LH US10A (US11)	45.45	002894		
		RH US10A (US11)	45.45	002895		
		LHUS10B	45.45	017887		
		RH US10B	45.45	017888		
		LH US26D	38.00	002900		
		RH US26D	38.00	002901		
	Available with ETW 4-1/2" x 4-1/2" (114 mm x 114 mm)	LH USP	33.45	002958		3 48
		RH USP	33.45	002963		
		LH US10	29.05	002918		
		RH US10	29.05	002919		
LH US10A (US11)		45.45	002921			
RH US10A (US11)		45.45	002924			
LHUS10B		45.45	002926			
RH US10B		45.45	002927			
LH US26D		38.00	002936			
RH US26D		38.00	002937			



1. Items with the price in **bold and red** are Quick Ship items and ship in 24 hours.
Please use stock number when ordering. 2. U/M is each unless otherwise noted.



Commercial Hinges



Description	Finish	2021 List	Stock No.	Box Qty.	Case Qty.
AB923					
4-1/2" x 4"	LH US3	94.95	037373	3	48
Brass or Stainless	RH US3	94.95	037374		
(114 mm x 102 mm)	LH US4	74.40	017474		
Full Mortise	RH US4	74.40	-		
Standard Weight	LH US10	74.40	053643		
Concealed Anti-Friction Bearing	RH US10	74.40	053640		
Two Knuckle	LH US10B	94.95	064730		
Specify Handing	RH US10B	94.95	064731		
	LH US26	94.95	048404		
Available with ETW	RH US26	94.95	048405		
	LH US26D	84.40	057100		
	RH US26D	84.40	057102		
	LH US32	110.60	039538		
	RH US32	110.60	085667		
	LH US32D	110.60	040225		
	RH US32D	110.60	031930		
<hr/>					
4-1/2" x 4-1/2"	LH US3	94.95	048410	3	48
(114 mm x 114 mm)	RH US3	94.95	048411		
	LH US4	74.40	063272		
	RH US4	74.40	050767		
	LH US10	74.40	041925		
	RH US10	74.40	041924		
	LH US10B	94.95	027478		
	RH US10B	94.95	027479		
	LH US26	94.95	020180		
	RH US26	94.95	035847		
	LH US26D	84.40	039586		
	RH US26D	84.40	027480		
	LH US32	110.60	030201		
	RH US32	110.60	030202		
	LH US32D	110.60	021425		
	RH US32D	110.60	021427		

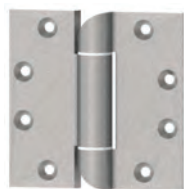

Description	Finish	2021 List	Stock No.	Box Qty.	Case Qty.	
IHTHB953 Stainless Steel Full Mortise Heavy Weight Concealed Bearing Institutional or Prison Welded Hospital Tip Standard with RSS and Torx Screws	US32D	132.35	051344	3	24	
990 Steel Detention Utility Hinge Full Surface Welded Tip	USP	176.60	079393	2	10	
992 Steel Detention Food Pass Through Hinge Full Surface With Stop Welded Tip Set of 2 hinges with 2 stops	USP	378.05	079398	1	12	
BB1109 Brass or Stainless Half Mortise Standard Weight Ball Bearing	4-1/2" (114 mm)	US10	150.25	004145	3	48
		US10B	185.05	085217		
		US26D	160.90	004149		
		US32D	214.15	004154		
	5" (127 mm)	US10	193.45	045318	3	24
	US10B	217.30	-			
	US26D	189.00	004165			
	US32D	256.35	004170			
1129 Steel Half Mortise Standard Weight Plain Bearing	4-1/2" (114 mm)	USP	28.05	004186	3	48
		US10	32.35	004175		
		US10A (US11)	48.05	007852		
		US10B	48.05	065372		
	US26D	36.70	004180			

1. Items with the price in **bold and red** are Quick Ship items and ship in 24 hours.
Please use stock number when ordering. 2. U/M is each unless otherwise noted.



Commercial Hinges



Description		Finish	2021 List	Stock No.	Box Qty.	Case Qty.
BB1129	4-1/2" (114 mm)	USP	72.40	004209	3	48
Steel		US10B	107.80	004193		
Half Mortise		US26D	85.15	004197		
Standard Weight						
Plain Bearing						
	5" (127 mm)	USP	97.55	004254	3	24
		US10B	140.05	-		
		US26D	122.05	004250		



1150	4-1/2" x 4"	US32	154.60	047217	3	48
Stainless Steel	(114 mm x 102 mm)	US32D	132.90	023378		
Full Mortise		US10Z	174.15	177119	3	48
Standard Weight						
Spring Hinge	4-1/2" x 4-1/2"	US32	154.60	028073	3	48
	(114 mm x 114 mm)	US32D	132.90	023379		
		US10Z	169.05	177118	3	48

Note: Hager does not recommend using spring hinges on doors over 7'0"





Description	Finish	2021 List	Stock No.	Box Qty.	Case Qty.
BB1168 Steel Full Mortise Heavy Weight Ball Bearing	4-1/2" x 4" (114 mm x 102 mm)	LS	58.15	-	3 24
		USP	58.15	004540	
		US3	69.05	004529	
		US10	58.15	004501	
		US10A (US11)	69.05	004505	
		US10B	69.05	004510	
		US15	69.05	084310	
		US26	69.05	004512	
		US26D	49.75	004517	
	4-1/2" x 4-1/2" (114 mm x 114 mm)	LS	58.15	004735	3
USP		58.15	004744		
US3		69.05	004671		
US10		58.15	004547		
US10A (US11)		69.05	004564		
US10B		69.05	004585		
US15		69.05	004592		
US26		69.05	004601		
US26D		49.75	004616		
5" x 4" (127 mm x 102 mm)		LS	74.80	-	3
	USP	73.70	004794		
	US3	77.90	010504		
	US10	74.80	071777		
	US10A (US11)	77.90	004779		
	US10B	77.90	059153		
	US15	77.90	035760		
	US26	77.90	047535		
	US26D	64.15	004785		
	5" x 4-1/2" (127 mm x 114 mm)	LS	74.80	128700	3
USP		73.70	004922		
US3		77.90	004881		
US10		74.80	004802		
US10A (US11)		77.90	004813		
US10B		77.90	004826		
US15		77.90	004830		
US26		77.90	004836		
US26D		64.15	004850		

1. Items with the price in **bold and red** are Quick Ship items and ship in 24 hours.
Please use stock number when ordering. 2. U/M is each unless otherwise noted.



Commercial Hinges



Description	Finish	2021 List	Stock No.	Box Qty.	Case Qty.	
BB1168 - Cont. Continued	5" x 5" (127 mm x 127 mm)	LS	74.80	-	3	24
		USP	73.70	005029		
		US3	77.90	004998		
		US10	74.80	004947		
		US10A (US11)	77.90	004956		
		US10B	77.90	004974		
		US15	77.90	022614		
		US26	77.90	004975		
		US26D	64.15	004981		
6" x 4-1/2" (152 mm x 114 mm)	LS	207.05	-	3	12	
	USP	200.35	005069			
	US3	255.30	005064			
	US10	207.05	035454			
	US10A (US11)	255.30	057799			
	US10B	255.40	068270			
	US15	255.30	033562			
	US26	255.40	005054			
	US26D	192.60	005057			
6" x 5" (152 mm x 127 mm)	USP	200.35	005102	3	12	
	US10	207.05	007229			
	US10A (US11)	255.30	020131			
	US10B	255.40	078457			
	US15	255.30	030967			
	US26D	192.60	005086			
6" x 6" (152 mm x 152 mm)	USP	200.35	005128	3	12	
	US10	207.05	030639			
	US10A (US11)	255.30	011627			
	US10B	255.40	065303			
	US15	255.30	016874			
	US26D	192.60	005113			
8" x 6" (203 mm x 152 mm)	USP	462.65	005145	3	12	
	US10	478.20	026481			
	US10A (US11)	589.65	-			
	US10B	589.65	039286			
	US15	589.65	-			
	US26D	500.95	064840			
8" x 8" (203 mm x 203 mm)	USP	462.65	005158	3	12	
	US10	487.20	-			
	US10A (US11)	589.65	005148			
	US10B	589.65	017141			
	US15	589.65	-			
	US26D	500.95	005151			



Description	Finish	2021 List	Stock No.	Box Qty.	Case Qty.
WTBB1168					
Wide Throw	4-1/2" x 5"	LS	135.45	-	3 24
Steel	(114 mm x 127 mm)	USP	146.85	097956	
Full Mortise		US3	165.20	004408	
Heavy Weight		US10	135.45	012221	
Ball Bearing		US10A (US11)	165.20	004403	
		US10B	165.20	007916	
		US26	165.20	015160	
		US26D	139.75	092594	
<hr/>					
	4-1/2" x 6"	LS	136.10	-	3 24
	(114 mm x 152 mm)	USP	147.60	004427	
		US3	166.05	004422	
		US10	136.10	099482	
		US10A (US11)	166.05	098167	
		US10B	166.05	004417	
		US26	166.05	004419	
		US26D	142.45	004420	
<hr/>					
	4-1/2" x 7"	LS	179.70	-	3 24
	(114 mm x 178 mm)	USP	194.95	040653	
		US3	219.20	015930	
		US10	179.70	003123	
		US10A (US11)	219.20	010920	
		US10B	219.20	058190	
		US26	219.20	050632	
		US26D	188.15	004435	
<hr/>					
	4-1/2" x 8"	LS	187.55	-	3 24
	(114 mm x 203 mm)	USP	203.40	004450	
		US3	228.80	078934	
		US10	187.55	045774	
		US10A (US11)	228.00	019132	
		US10B	228.00	062081	
		US26	228.00	066672	
		US26D	196.35	004446	
<hr/>					
	5" x 6"	LS	183.05	-	3 24
	(127 mm x 152 mm)	USP	198.30	008259	
		US3	222.05	004463	
		US10	183.05	020214	
		US10A (US11)	222.05	031197	
		US10B	222.05	019659	
		US26	222.05	004459	
		US26D	189.75	004461	

1. Items with the price in **bold and red** are Quick Ship items and ship in 24 hours.
 Please use stock number when ordering. 2. U/M is each unless otherwise noted.



Commercial Hinges



Description	Finish	2021 List	Stock No.	Box Qty.	Case Qty.
WTBB1168 - Cont. Continued	5" x 7" (127 mm x 203 mm)	LS	185.75	-	3 24
		USP	201.30	066742	
		US3	225.15	067657	
		US10	185.75	023928	
		US10A (US11)	225.15	020805	
		US10B	225.15	073756	
		US26	225.15	143181	
		US26D	192.55	004475	
5" x 8" (127 mm x 203 mm)	LS	193.70	-	3 24	
	USP	209.95	004495		
	US3	235.00	008357		
	US10	193.70	034739		
	US10A (US11)	235.00	015855		
	US10B	235.00	026651		
	US26	235.00	057245		
	US26D	200.75	098271		
1173 Steel Half Surface Standard Weight Plain Bearing	3-1/2" (89 mm)	USP	40.10	005304	3 48
		US10	44.70	005292	
		US10A (US11)	53.30	005293	
		US10B	53.30	024439	
		US26D	46.90	005295	
4" (102 mm)	USP	61.35	005319	3 48	
	US10	64.55	005306		
	US10A (US11)	76.15	046712		
	US10B	76.15	044390		
	US26D	66.40	005309		
4-1/2" (114 mm)	USP	41.30	005337	3 48	
	US10	44.20	005321		
	US10A (US11)	60.70	005323		
	US10B	60.70	001848		
	US26D	46.65	005326		
BB1173 Steel Half Surface Standard Weight Ball Bearing	4" (102 mm)	USP	78.25	005356	3 48
		US10	93.85	005349	
		US10A (US11)	117.80	001845	
		US10B	117.80	091863	
		US26D	102.85	005351	
4-1/2" (114 mm)	USP	63.05	005389	3 48	
	US10	70.50	005358		
	US10A (US11)	98.25	005360		
	US10B	98.25	005364		
	US26D	73.90	005367		
5" (127 mm)	USP	89.10	005410	3 36	
	US10	108.95	005395		
	US10A (US11)	134.60	005397		
	US10B	134.60	015735		
	US26D	100.30	005401		





Description	Finish	2021 List	Stock No.	Box Qty.	Case Qty.	
1191 Brass or Stainless Full Mortise Standard Weight Plain Bearing Specify if all wood screws are required.	3" x 3" (76 mm x 76 mm)	US3	179.90	005484	2	100
		US4	141.15	005496		
		US10	141.15	065549		
		US10B	179.90	005475		
		US15	179.90	005478		
		US26	179.90	005479		
		US26D	159.40	005481		
		US32	200.10	005490		
		US32D	197.85	005491		
	3-1/2" x 3-1/2" (89 mm x 89 mm)	US3	74.30	006934		
US4		58.15	006952			
US10		58.15	006911			
US10B		74.30	006913			
US15		74.30	006920			
US26		74.30	006923			
US26D		66.50	006929			
US32		74.45	006943			
US32D		70.15	006945			
4" x 3-1/2" (102 mm x 89 mm)	US3	92.90	097274	3	48	
	US4	70.95	005502			
	US10	70.95	121560			
	US10B	92.90	069063			
	US15	92.90	035011			
	US26	92.90	011778			
	US26D	81.00	029852			
	US32	91.45	132157			
	US32D	84.80	088102			
4" x 4" (102 mm x 102 mm)	US3	71.50	005535	3	48	
	US4	55.60	005562			
	US10	55.60	005503			
	US10B	71.50	005508			
	US15	71.50	052318			
	US26	71.50	005522			
	US26D	66.00	005528			
	US32	76.05	005549			
	US32D	68.40	005552			

1. Items with the price in **bold and red** are Quick Ship items and ship in 24 hours.
Please use stock number when ordering. 2. U/M is each unless otherwise noted.



Commercial Hinges



Description	Finish	2021 List	Stock No.	Box Qty.	Case Qty.	
1191 - Cont. Continued	4-1/2" x 4"	US3	72.65	005597	3	48
	(114 mm x 102 mm)	US4	57.20	005620		
		US10	57.20	052272		
		US10B	72.65	005582		
		US15	72.65	005586		
		US26	72.65	005590		
		US26D	60.70	005592		
		US32	73.15	005611		
		US32D	68.00	005614		
4-1/2" x 4-1/2"	US3	72.65	005690	3	48	
	(114 mm x 114 mm)	US4	57.20			005724
		US10	57.20			005629
		US10B	72.65			005640
		US15	72.65			005652
		US26	72.65			005664
		US26D	60.70			005673
		US32	73.15			005709
		US32D	68.00			005713
5" x 4"	US3	101.40	005752	3	24	
	(127 mm x 102 mm)	US4	80.95			110512
		US10	80.95			-
		US10B	101.40			012964
		US15	101.40			047207
		US26	101.40			043361
		US26D	90.05			033877
		US32	112.75			046989
		US32D	102.60			005755
5" x 4-1/2"	US3	101.40	005771	3	24	
	(127 mm x 114 mm)	US4	80.95			005783
		US10	80.95			105329
		US10B	101.40			005763
		US15	101.40			032825
		US26	101.40			068935
		US26D	90.05			005768
		US32	112.75			125488
		US32D	102.60			005779
5" x 5"	US3	101.40	005803	3	24	
	(127 mm x 127 mm)	US4	80.95			027281
		US10	80.95			128170
		US10B	101.40			005791
		US15	101.40			030280
		US26	101.40			005799
		US26D	90.05			005800
		US32	112.75			009578
		US32D	102.60			005815





Description	Finish	2021 List	Stock No.	Box Qty.	Case Qty.	
BB1191 Brass or Stainless Full Mortise Standard Weight Ball Bearing Specify if all wood screws are required.	3-1/2" x 3-1/2" (89 mm x 89 mm)	US3	88.15	007012	2	100
		US4	82.10	007026		
		US10	82.10	006997		
		US10B	88.15	007000		
		US15	88.15	039663		
		US26	88.15	007006		
		US26D	86.30	007008		
		US32	121.95	007020		
		US32D	107.75	007021		
	4" x 3-1/2" (102 mm x 89 mm)	US3	133.45	080659	3	48
		US4	102.35	-		
		US10	102.35	-		
		US10B	133.45	091160		
US15		133.45	095215			
US26		133.45	-			
US26D		128.70	072201			
US32		161.35	085839			
4" x 4" (102 mm x 102 mm)	US3	101.80	006246	3	48	
	US4	89.35	006269			
	US10	89.35	006221			
	US10B	101.80	006225			
	US15	101.80	006232			
	US26	101.80	006235			
	US26D	95.55	006240			
	US32	120.50	006261			
4-1/2" x 4" (114 mm x 102 mm)	US3	86.75	006321	3	48	
	US4	66.75	006343			
	US10	66.75	006286			
	US10B	86.75	006289			
	US15	86.75	006302			
	US26	86.75	006306			
	US26D	67.65	006311			
	US32	81.05	006332			
	US32D	68.65	006335			

1. Items with the price in **bold and red** are Quick Ship items and ship in 24 hours.
Please use stock number when ordering. 2. U/M is each unless otherwise noted.



Commercial Hinges



Description	Finish	2021 List	Stock No.	Box Qty.	Case Qty.	
BB1191 - Cont. Continued	4-1/2" x 4-1/2" (114 mm x 114 mm)	US3	86.75	006489	3	48
		US4	66.75	006562		
		US10	66.75	006373		
		US10B	86.75	006393		
		US15	86.75	006426		
		US26	86.75	006446		
		US26D	67.65	006462		
		US32	81.05	006528		
		US32D	68.65	006537		
5" x 4" (127 mm x 102 mm)		US3	118.65	006630	3	24
		US4	92.40	069057		
		US10	92.40	020761		
		US10B	118.65	006621		
		US15	118.65	043259		
		US26	118.65	006623		
		US26D	96.55	006627		
		US32	116.30	047877		
		US32D	98.70	006636		
5" x 4-1/2" (127 mm x 114 mm)		US3	118.65	006681	3	24
		US4	92.40	006707		
		US10	92.40	006644		
		US10B	118.65	006655		
		US15	118.65	006665		
		US26	118.65	065277		
		US26D	96.55	006672		
		US32	116.30	006693		
		US32D	98.70	006696		
5" x 5" (127 mm x 127 mm)		US3	118.65	006761	3	24
		US4	92.40	006791		
		US10	92.40	006727		
		US10B	118.65	006733		
		US15	118.65	068939		
		US26	118.65	006746		
		US26D	96.55	006752		
		US32	116.30	006779		
		US32D	98.70	006784		



Description	Finish	2021 List	Stock No.	Box Qty.	Case Qty.	
BB1191 - Cont. 2 Continued	6" x 4-1/2" (152 mm x 114 mm)	US3	371.30	006813	3	24
		US4	291.75	030956		
		US10	291.75	010566		
		US10B	371.30	007519		
		US15	371.30	-		
		US26	371.30	099318		
		US26D	333.90	006811		
		US32	405.85	084160		
		US32D	405.85	006817		
	6" x 5" (152 mm x 127 mm)	US3	371.30	006830		
US4		291.75	081058			
US10		291.75	031360			
US10B		371.30	069067			
US15		371.30	117950			
US26		371.30	-			
US26D		333.90	019124			
US32		405.85	-			
US32D		405.85	006832			
6" x 6" (152 mm x 152 mm)		US3	371.30	006843	3	24
	US4	291.75	046772			
	US10	291.75	012558			
	US10B	371.30	006838			
	US15	371.30	070946			
	US26	371.30	147729			
	US26D	333.90	006842			
	US32	405.85	106911			
	US32D	405.85	006850			

1. Items with the price in **bold and red** are Quick Ship items and ship in 24 hours.
Please use stock number when ordering. 2. U/M is each unless otherwise noted.



Commercial Hinges



Description	Finish	2021 List	Stock No.	Box Qty.	Case Qty.		
WTBB1191 Wide Throw Brass or Stainless Full Mortise Standard Weight Ball Bearing	3-1/2" x 5" (89 mm x 127 mm)	US3	158.75	067005	3	24	
		US4	123.40	026605			
		US10	123.40	121849			
		US10B	158.75	075305			
		US26	158.75	129251			
		US26D	139.30	118052			
		US32	190.80	000080			
		US32D	190.80	032663			
		3-1/2" x 6" (89 mm x 152 mm)	US3	159.40	040163	3	24
		US4	127.85	-			
	US10	127.85	-				
	US10B	159.40	113815				
	US26	159.40	-				
	US26D	143.65	130243				
	US32	198.00	138152				
	US32D	198.00	076662				
	4" x 5" (102 mm x 127 mm)	US3	199.30	010124	3	24	
		US4	156.90	037602			
		US10	156.90	086104			
		US10B	199.30	070966			
		US26	199.30	041818			
		US26D	175.35	038964			
		US32	214.10	-			
		US32D	214.10	075139			
	4" x 6" (102 mm x 152 mm)	US3	207.15	006119	3	24	
		US4	163.80	012392			
		US10	163.80	146501			
		US10B	207.15	006117			
		US26	207.15	096937			
		US26D	181.90	009831			
		US32	221.70	114550			
		US32D	221.70	006121			



Description	Finish	2021 List	Stock No.	Box Qty.	Case Qty.	
WTBB1191 - Cont. Continued	4" x 7"	US3	216.20	092349	3	24
	(102 mm x 178 mm)	US4	172.35	089839		
		US10	172.35	-		
		US10B	216.20	039719		
		US26	216.20	069207		
		US26D	189.45	088865		
		US32	230.85	099920		
		US32D	230.85	048155		
4-1/2" x 5"	(114 mm x 127 mm)	US3	178.00	094007	3	24
		US4	134.75	101381		
		US10	134.75	046401		
		US10B	178.00	025650		
		US26	178.00	001393		
		US26D	152.85	092728		
		US32	188.20	121467		
		US32D	188.20	006144		
4-1/2" x 6"	(114 mm x 152 mm)	US3	196.10	095253	3	24
		US4	150.55	036949		
		US10	150.55	024066		
		US10B	196.10	006152		
		US26	196.10	020291		
		US26D	177.75	065373		
		US32	206.40	052335		
		US32D	206.40	092901		
4-1/2" x 7"	(114 mm x 178 mm)	US3	190.80	080909	3	24
		US4	154.35	041505		
		US10	154.35	-		
		US10B	190.80	024545		
		US26	190.80	049886		
		US26D	178.85	069011		
		US32	212.10	076444		
		US32D	212.10	099811		
4-1/2" x 8"	(114 mm x 203 mm)	US3	206.35	072567	3	24
		US4	160.00	116184		
		US10	160.00	048605		
		US10B	206.35	034770		
		US26	206.35	060370		
		US26D	180.00	008143		
		US32	216.75	-		
		US32D	216.75	098630		
5" x 6"	(127 mm x 152 mm)	US3	382.30	006199	3	24
		US4	292.05	067616		
		US10	292.05	028304		
		US10B	382.30	046882		
		US26	382.30	-		
		US26D	338.10	033730		
		US32	406.05	046097		
		US32D	406.05	040909		

1. Items with the price in **bold and red** are Quick Ship items and ship in 24 hours.
Please use stock number when ordering. 2. U/M is each unless otherwise noted.



Commercial Hinges



Description	Finish	2021 List	Stock No.	Box Qty.	Case Qty.
WTBB1191 - Cont. 2 Continued	5" x 7" (127 mm x 178 mm)	US3	401.80	067159	3 24
		US4	306.75	-	
		US10	306.75	-	
		US10B	401.80	035145	
		US26	401.80	-	
		US26D	348.40	065278	
		US32	425.70	-	
		US32D	425.70	036859	
	5" x 8" (127 mm x 203 mm)	US3	418.35	074194	3 24
		US4	338.70	-	
US10		338.70	038873		
US10B		418.35	020027		
US26		418.35	-		
US26D		365.35	025454		
US32		436.45	-		
US32D		436.45	072530		
BB1195 Brass or Stainless Full Mortise Heavy Weight Ball Bearing Anchor Hinge Specify Handing	5" x 4-1/2" (127 mm x 114 mm)	LH US10	380.40	037675	1 10
		RH US10	380.40	037676	
		LH US10B	454.75	079470	
		RH US10B	454.75	079471	
		LH US26D	427.10	065411	
		RH US26D	427.10	065412	
		LH US32D	490.65	062056	
		RH US32D	490.65	062057	
BB1196 Brass or Stainless Full Mortise Heavy Weight Ball Bearing Anchor Hinge for Beveled Edge Doors Specify Handing	5" x 4-1/2" (127 mm x 114 mm)	LH US10	380.40	085583	1 10
		RH US10	380.40	085582	
		LH US10B	454.75	065640	
		RH US10B	454.75	065641	
		LH US26D	427.10	073416	
		RH US26D	427.10	073415	
		LH US32D	490.65	063230	
		RH US32D	490.65	063231	
BB1197 Brass or Stainless Full Mortise Heavy Weight Ball Bearing Anchor Hinge Beveled Edge Doors Specify Handing	5" x 4-1/2" (127 mm x 114 mm)	LH US10	380.40	003650	1 10
		RH US10	380.40	088543	
		LH US10B	454.75	067686	
		RH US10B	454.75	067687	
		LH US26D	427.10	074907	
		RH US26D	427.10	074908	
		LH US32D	490.65	079648	
		RH US32D	490.65	079649	





Description	Finish	2021 List	Stock No.	Box Qty.	Case Qty.
BB1199 Brass or Stainless Full Mortise Heavy Weight Ball Bearing	4-1/2" x 4" (114 mm x 102 mm)	US3 129.80	007369	3	24
		US4 119.75	007381		
		US10 119.75	019651		
		US10B 129.80	007354		
		US15 129.80	035768		
		US26 129.80	007362		
		US26D 102.80	007364		
		US32 104.95	007376		
		US32D 104.05	007378		
	4-1/2" x 4-1/2" (114 mm x 114 mm)	US3 129.80	007469		
US4 119.75		007520			
US10 119.75		007390			
US10B 129.80		007406			
US15 129.80		007424			
US26 129.80		007437			
US26D 102.80		007445			
US32 104.95		007496			
5" x 4" (127 mm x 102 mm)	US3 165.70	007564	3	24	
	US4 139.45	069122			
	US10 139.45	064950			
	US10B 165.70	007557			
	US15 165.70	087838			
	US26 165.70	091928			
	US26D 139.55	007561			
	US32 142.00	199969			
5" x 4-1/2" (127 mm x 114 mm)	US3 165.70	007619	3	24	
	US4 139.45	007651			
	US10 139.45	007576			
	US10B 165.70	007585			
	US15 165.70	065583			
	US26 165.70	007601			
	US26D 139.55	007607			
	US32 142.00	007634			
5" x 5" (127 mm x 127 mm)	US3 165.70	007717	3	24	
	US4 139.45	007752			
	US10 139.45	007678			
	US10B 165.70	007689			
	US15 165.70	040362			
	US26 165.70	007703			
	US26D 139.55	007707			
	US32 142.00	007738			
	US32D 142.00	007742			

1. Items with the price in **bold and red** are Quick Ship items and ship in 24 hours.
Please use stock number when ordering. 2. U/M is each unless otherwise noted.



Commercial Hinges



Description	Finish	2021 List	Stock No.	Box Qty.	Case Qty.	
BB1199 - Cont. Continued	6" x 4-1/2" (152 mm x 114 mm)	US3	385.55	011566	3	12
		US4	250.44	018196		
		US10	250.44	099882		
		US10B	385.55	094854		
		US15	385.55	031525		
		US26	385.55	-		
		US26D	271.85	007775		
		US32	367.75	058406		
		US32D	367.75	007783		
6" x 5" (152 mm x 127 mm)	US3	385.55	007803	3	12	
	US4	250.45	013028			
	US10	250.45	019745			
	US10B	385.55	007792			
	US15	385.55	055244			
	US26	385.55	-			
	US26D	271.85	007800			
	US32	367.75	048380			
	US32D	367.75	007807			
6" x 6" (152 mm x 152 mm)	US3	385.55	007827	3	12	
	US4	250.45	007838			
	US10	250.45	007816			
	US10B	385.55	007820			
	US15	385.55	040565			
	US26	385.55	116381			
	US26D	271.85	007825			
	US32	367.75	073209			
	US32D	367.75	007832			
8" x 6" (203 mm x 152 mm)	USP	616.40	054124	3	12	
	US3	874.75	017553			
	US10	647.05	071278			
	US10B	874.75	072364			
	US15	874.75	095022			
	US26D	760.80	003819			
	US32D	1,014.15	007853			
8" x 8" (203 mm x 203 mm)	USP	616.40	046441	3	12	
	US3	874.75	073590			
	US10	647.05	025171			
	US10B	874.75	007857			
	US15	874.75	124169			
	US26D	760.80	032486			
	US32D	1,014.15	007863			



Description	Finish	2021 List	Stock No.	Box Qty.	Case Qty.		
WTBB1199 Wide Throw Brass or Stainless Full Mortise Heavy Weight Ball Bearing	4-1/2" x 5" (114 mm x 127 mm)	US3	304.45	007267	3	24	
		US4	240.40	065299			
		US10	240.40	031727			
		US10B	304.45	021314			
		US26	304.45	017632			
		US26D	264.00	007274			
		US32	326.60	089866			
		US32D	326.60	098011			
		4-1/2" x 6" (114 mm x 152 mm)	US3	313.40	023840	3	24
		US4	248.60	068984			
	US10	248.60	048525				
	US10B	313.40	055190				
	US26	313.40	033508				
	US26D	281.80	076837				
	US32	335.30	015353				
	US32D	335.30	007302				
	4-1/2" x 7" (114 mm x 178 mm)	US3	330.95	103595	3	24	
	US4	275.40	051679				
	US10	275.40	013416				
	US10B	330.95	007306				
	US26	330.95	-				
	US26D	317.75	018563				
	US32	357.50	-				
	US32D	357.50	099677				
	4-1/2" x 8" (114 mm x 203 mm)	US3	357.50	028182	3	24	
	US4	304.50	091502				
	US10	304.50	087891				
	US10B	357.50	039213				
	US26	357.50	069204				
	US26D	330.95	105127				
	US32	386.60	051771				
	US32D	386.60	020980				
	5" x 6" (127 mm x 152 mm)	US3	370.70	048922	3	24	
	US4	317.75	021718				
	US10	317.75	125775				
	US10B	370.70	032471				
	US26	370.70	-				
	US26D	341.55	030677				
	US32	413.05	095695				
	US32D	413.05	007332				
	5" x 7" (127 mm x 178 mm)	US3	383.95	046417	3	24	
	US4	317.75	-				
	US10	317.75	102105				
	US10B	383.95	065989				
	US26	383.95	-				
	US26D	344.25	048069				
	US32	418.35	074499				
	US32D	418.35	030561				

1. Items with the price in **bold and red** are Quick Ship items and ship in 24 hours.
Please use stock number when ordering. 2. U/M is each unless otherwise noted.



Commercial Hinges



Description	Finish	2021 List	Stock No.	Box Qty.	Case Qty.	
WTBB1199 - Cont. Continued	5" x 8" (127 mm x 203 mm)	US3	399.80	084305	3	24
		US4	341.55	142606		
		US10	341.55	-		
		US10B	399.80	005340		
		US26	399.80	-		
		US26D	357.50	034917		
		US32	436.90	-		
	US32D	436.90	019520			



1250 Steel Full Mortise Standard Weight Spring Hinge Available with Raised Barrel Available with hospital tip (voids UL)	3-1/2" x 3-1/2" (89 mm x 89 mm)	USP	31.20	007989	2	80
		US3	41.30	007984		
		US4	31.20	007986		
		US10	31.20	007974		
		US10A (US11)	41.30	007975		
		US10B	41.30	007977		
		US26D	42.15	007981		



Note: Hager does not recommend using spring hinges on doors over 7'0"

4" x 4" (102 mm x 102 mm)	USP	39.75	008006	3	48
	US3	55.30	008001		
	US4	39.75	008003		
	US10	39.75	007991		
	US10A (US11)	55.30	007992		
	US10B	55.30	007994		
	US26D	48.85	007999		

4-1/2" x 4" (114 mm x 102 mm)	USP	71.00	008020	3	48
	US3	67.35	008014		
	US4	71.00	008015		
	US10	71.00	008008		
	US10A (US11)	67.35	008009		
	US10B	67.35	008010		
	US26D	64.15	008013		

4-1/2" x 4-1/2" (114 mm x 114 mm)	USP	71.00	008050	3	48
	US3	67.35	008039		
	US4	71.00	008041		
	US10	71.00	008021		
	US10A (US11)	67.35	008023		
	US10B	67.35	008025		
	US26	67.35	008034		
	US26D	64.15	008037		



1251 Steel 1/4" Round Corner Radius, Full Mortise Standard Weight Spring Hinge	4" x 4" (102 mm x 102 mm)	USP	39.75	008079	3	48
		US3	55.30	008073		
		US4	39.75	008074		
		US10	39.75	008067		
		US10A (US11)	55.30	008069		
		US10B	55.30	067122		
		US26D	48.85	008072		



Note: Hager does not recommend using spring hinges on doors over 7'0"



Description	Finish	2021 List	Stock No.	Box Qty.	Case Qty.
1251 - Cont. Continued	4-1/2" x 4" (114 mm x 102 mm)	USP	69.05	008086	3 48
		US3	95.70	003696	
		US4	85.10	008084	
		US10	85.10	012636	
		US10A (US11)	95.70	072921	
		US10B	95.70	038047	
		US26D	92.25	008082	
4-1/2" x 4-1/2" (114 mm x 114 mm)	USP	69.05	008093	3 48	
	US3	95.70	008091		
	US4	85.10	008092		
	US10	85.10	008087		
	US10A (US11)	95.70	008088		
	US10B	95.70	020899		
	US26D	92.25	008090		



1252 Steel 5/8" Round Corner Radius Full Mortise Standard Weight Spring Hinge	4" x 4" (102 mm x 102 mm)	USP	39.75	008111	3 48
		US3	55.30	008106	
		US4	39.75	008107	
		US10	39.75	008102	
		US10A (US11)	55.30	008103	
		US10B	55.30	079680	
		US26D	48.85	008105	
Note: Hager does not recommend using spring hinges on doors over 7'0"	4-1/2" x 4" (114 mm x 102 mm)	USP	69.05	094477	3 48
		US3	95.70	131917	
		US4	85.10	128797	
		US10	85.10	-	
		US10A (US11)	95.70	-	
		US10B	95.70	066475	
		US26D	92.25	008112	



1253 Steel Half Surface Standard Weight Spring Hinge	4-1/2" (114 mm)	USP	105.30	008126	3 48
		US3	145.70	008122	
		US4	126.65	008123	
		US10	126.65	068449	
		US10A (US11)	145.70	040132	
		US10B	145.70	029321	
	US26D	149.60	008121		



1. Items with the price in **bold and red** are Quick Ship items and ship in 24 hours.
Please use stock number when ordering. 2. U/M is each unless otherwise noted.



Commercial Hinges



Description	Finish	2021 List	Stock No.	Box Qty.	Case Qty.
1255	USP	179.95	059982	1	16
Steel, Full Mortise	US3	188.60	069391		
Standard Weight	US4	189.75	072216		
Spring Hinge Set	US10B	188.60	015725		
2 ea. 1250 and 1 ea. AB700	US26D	165.15	050862		

Note: Hager does not recommend using spring hinges on doors over 7'0"



1256	USP	175.90	066379	1	16
Steel	US3	181.85	066381		
Full Mortise	US4	184.15	066382		
Standard Weight	US10B	181.85	078188		
Spring Hinge Set	US26D	161.30	066380		
2 ea. 1250 and 1 ea. BB1279					

Note: Hager does not recommend using spring hinges on doors over 7'0"



1257	USP	80.15	028435	3	48
Steel	US3	113.20	043734		
Reverse Action (opens door)	US4	98.55	031889		
Spring Hinge	US10	98.55	025898		
Full Mortise	US10A (US11)	113.20	053642		
Standard Weight	US10B	113.20	028288		
	US26D	108.75	023280		

Note: Hager does not recommend using spring hinges on doors over 7'0"





Description	Finish	2021 List	Stock No.	Box Qty.	Case Qty.
1260					
Steel	USP	74.00	008132	3	48
Full Mortise	US3	110.70	008130		
Standard Weight	US4	80.75	008131		
Swing Clear	US10	91.65	008127		
	US10A (US11)	110.70	057903		
	US10B	110.70	019620		
	US26	110.70	008128		
	US26D	87.75	008129		
<hr/>					
	4" (102 mm)	USP	87.75	008134	3 36
		US3	113.15	051811	
		US4	90.25	051756	
		US10	94.70	052043	
		US10A (US11)	113.15	097783	
		US10B	113.15	018275	
		US26	113.15	008133	
		US26D	90.25	053701	
<hr/>					
BB1260					
Steel	USP	156.65	008150	3	36
Full Mortise	US10	163.05	008137		
Standard Weight	US10A (US11)	192.60	008140		
Ball Bearing	US10B	192.60	062238		
Swing Clear	US26D	167.00	008142		
RH Standard (Reversible to LH)					
<hr/>					
	5" (127 mm)	USP	156.65	008157	3 36
		US10	163.05	016025	
		US10A (US11)	192.60	008154	
		US10B	192.60	061702	
		US26D	167.00	008156	
<hr/>					
BB1261					
Steel	USP	156.65	008174	3	36
Full Mortise	US10	163.05	008161		
Standard Weight	US10A (US11)	192.60	008163		
Ball Bearing	US10B	192.60	098270		
Swing Clear	US26D	167.00	008166		
Beveled Edge Doors					
RH Standard (Reversible to LH)					
<hr/>					
	5" (127 mm)	USP	156.65	032933	3 36
		US10	163.05	083843	
		US10A (US11)	192.60	008175	
		US10B	192.60	073019	
		US26D	167.00	008177	
<hr/>					
BB1262					
Steel	USP	193.75	008193	3	24
Full Mortise	US10	196.55	008181		
Heavy Weight	US10A (US11)	236.05	008182		
Ball Bearing	US10B	236.05	080232		
Swing Clear	US26D	182.80	008186		
RH Standard (Reversible to LH)					
<hr/>					
	5" (127 mm)	USP	193.75	008205	3 24
		US10	196.55	008195	
		US10A (US11)	236.05	007128	
		US10B	236.05	022873	
		US26D	182.80	008199	



1. Items with the price in **bold and red** are Quick Ship items and ship in 24 hours.
 Please use stock number when ordering. 2. U/M is each unless otherwise noted.



Commercial Hinges



Description	Finish	2021 List	Stock No.	Box Qty.	Case Qty.
BB1263					
4-1/2" (114 mm)	USP	193.75	008223	3	24
Steel	US10	196.55	008212		
Full Mortise	US10A (US11)	236.05	008214		
Heavy Weight	US10B	236.05	008216		
Ball Bearing	US26D	182.80	008218		
Swing Clear					
5" (127 mm)	USP	193.75	008236	3	24
Beveled Edge Doors	US10	196.55	008225		
RH Standard (Reversible to LH)	US10A (US11)	236.05	008227		
	US10B	236.05	018189		
	US26D	182.80	008229		



BB1266					
5" (127 mm)	USP	379.45	008266	3	12
Steel	US10	398.20	071003		
Full Surface	US10A (US11)	598.15	026077		
Heavy Weight	US10B	598.15	060302		
Ball Bearing	US26D	474.15	008261		
Swing Clear					



1267					
4-1/2" (114 mm)	USP	195.70	135773	3	36
Steel	US3	227.95	121383		
Full Mortise	US10	205.90	-		
Swing Clear Spring Hinge	US10A (US11)	227.95	-		
Square Edge Doors	US10B	227.95	-		
Use with BB1260/AB7001	US26	227.95	-		
	US26D	216.55	113387		



Note: Hager does not recommend using spring hinges on doors over 7'0"



BB1277		109.40*	-	3	48
Made to Order		*Add to price of			
Steel		BB1279			
Full Mortise					
Standard Weight					
Ball Bearing					
Both Leaves Tapped					

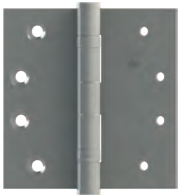

BB1278		109.40*	-	3	48
Steel		*Add to price of			
Full Mortise		BB1279			
Standard Weight					
Ball Bearing					
One Leaf Tapped					
Specify Handing					



1279					
3" x 3"	LS	27.80	008460	2	100
(76 mm x 76 mm)	H2H	56.20	008448		
Steel	USP	23.70	008461		
Full Mortise	US3	51.90	008449		
Standard Weight	US4	27.80	008454		
Plain Bearing	US10	27.80	008427		
	US10A (US11)	51.90	008429		
	US10B	51.90	064052		
	US15	51.90	008435		
	US26	51.90	008439		
	US26D	43.15	008442		





Description	Finish	2021 List	Stock No.	Box Qty.	Case Qty.			
1279 - Cont. Continued	3-1/2" x 3-1/2" (89 mm x 89 mm)	LS	9.70	010919	2	100		
		H2H	19.65	010881				
		USP	7.60	010923				
		US3	15.25	010886				
		US4	9.70	010897				
		US10	9.70	010819				
		US10A (US11)	15.25	010829				
		US10B	15.25	010839				
		US15	15.25	010850				
		US26	15.25	010859				
		US26D	12.75	010870				
	4" x 3-1/2" (102 x 89 mm)	LS	17.90	-			3	48
		H2H	29.05	-				
USP		13.80	000695					
US3		25.25	008469					
US4		16.20	096337					
US10		16.20	015158					
US10A (US11)		25.25	063165					
US10B		25.25	025812					
US15		25.25	041310					
US26		25.25	056835					
US26D		21.95	088103					
4" x 4" (102 mm x 102 mm)	LS	11.95	008583	3	48			
	H2H	21.45	008532					
	USP	9.40	008585					
	US3	17.15	008540					
	US4	11.95	008555					
	US10	11.95	008470					
	US10A (US11)	17.15	008477					
	US10B	17.15	008488					
	US15	17.15	008496					
	US26	17.15	008507					
	US26D	15.65	008517					
4-1/2" x 4" (114 mm x 102 mm)	LS	11.50	008648	3	48			
	H2H	24.70	067471					
	USP	9.90	008650					
	US3	19.80	008629					
	US4	11.50	008637					
	US10	11.50	008599					
	US10A (US11)	19.80	008602					
	US10B	19.80	008608					
	US15	19.80	008612					
	US26	19.80	008617					
	US26D	12.40	008622					

1. Items with the price in **bold and red** are Quick Ship items and ship in 24 hours.
Please use stock number when ordering. 2. U/M is each unless otherwise noted.



Commercial Hinges



Description	Finish	2021 List	Stock No.	Box Qty.	Case Qty.	
1279 - Cont. 2 Continued	4-1/2" x 4-1/2" (114 mm x 114 mm)	LS	11.50	008826	3	48
		H2H	24.70	008748		
		USP	9.90	008833		
		US3	19.80	008762		
		US4	11.50	008785		
		US10	11.50	008657		
		US10A (US11)	19.80	008671		
		US10B	19.80	008687		
		US15	19.80	008698		
		US26	19.80	008709		
		US26D	12.40	008720		
	5" x 4" (127 mm x 102 mm)	LS	39.75	-	3	24
		H2H	67.15	038234		
USP		32.70	008871			
US3		53.75	008863			
US4		39.75	008865			
US10		39.75	088473			
US10A (US11)		53.75	009784			
US10B		53.75	008536			
US15		53.75	068578			
US26		53.75	064843			
US26D		36.80	008862			
5" x 4-1/2" (127 mm x 114 mm)	LS	39.75	-	3	24	
	H2H	67.15	031063			
	USP	32.70	008911			
	US3	53.75	008895			
	US4	39.75	008900			
	US10	39.75	008875			
	US10A (US11)	53.75	008879			
	US10B	53.75	008882			
	US15	53.75	083724			
	US26	53.75	008884			
	US26D	36.80	008887			
5" x 5" (127 mm x 127 mm)	LS	39.75	081132	3	24	
	H2H	67.15	019652			
	USP	32.70	008963			
	US3	53.75	008944			
	US4	39.75	008956			
	US10	39.75	008923			
	US10A (US11)	53.75	008925			
	US10B	53.75	008929			
	US15	53.75	067162			
	US26	53.75	008934			
	US26D	36.80	008938			



Description	Finish	2021 List	Stock No.	Box Qty.	Case Qty.	
BB1279 Steel Full Mortise Standard Weight Ball Bearing	3-1/2" x 3-1/2" (89 mm x 89 mm)	LS	36.65	019111	2	100
		H2H	59.35	-		
		USP	36.65	011038		
		US3	47.50	011013		
		US4	36.65	011021		
		US10	36.65	010983		
		US10A (US11)	47.50	010988		
		US10B	47.50	010995		
		US15	47.50	060839		
		US26	47.50	010998		
		US26D	37.00	011003		
	4" x 3-1/2" (102 mm x 89 mm)	LS	43.20	-	3	48
		H2H	64.25	-		
		USP	39.45	072989		
US3		57.05	009726			
US4		39.45	028772			
US10		43.20	006898			
US10A (US11)		57.05	070929			
US10B		57.05	014742			
US15		57.05	029388			
US26		57.05	000728			
US26D		49.10	009725			
4" x 4" (102 mm x 102 mm)	LS	30.55	009805	3	48	
	H2H	46.15	020230			
	USP	26.75	009808			
	US3	36.95	009778			
	US4	26.75	009792			
	US10	30.55	009727			
	US10A (US11)	36.95	009731			
	US10B	36.95	009738			
	US15	36.95	009747			
	US26	36.95	009755			
	US26D	31.70	009763			
4-1/2" x 4" (114 mm x 102 mm)	LS	25.45	009933	3	48	
	H2H	38.45	045582			
	USP	17.95	009937			
	US3	30.75	009888			
	US4	25.45	009900			
	US10	25.45	009817			
	US10A (US11)	30.75	009825			
	US10B	30.75	009841			
	US15	30.75	009849			
	US26	30.75	009857			
	US26D	17.30	009868			

1. Items with the price in **bold and red** are Quick Ship items and ship in 24 hours.
Please use stock number when ordering. 2. U/M is each unless otherwise noted.



Commercial Hinges



Description	Finish	2021 List	Stock No.	Box Qty.	Case Qty.	
BB1279 - Cont. Continued	4-1/2" x 4-1/2" (114 mm x 114 mm)	LS	25.45	010310	3	48
		H2H	38.45	010172		
		USP	17.95	010322		
		US3	30.75	010189		
		US4	25.45	010230		
		US10	25.45	009957		
		US10A (US11)	30.75	009990		
		US10B	30.75	010029		
		US15	30.75	010048		
		US26	30.75	010073		
		US26D	16.75	010108		
	<hr/>					
	5" x 4" (127 mm x 102 mm)		LS	49.70	-	3
		H2H	78.70	-		
		USP	49.70	010411		
		US3	62.95	010397		
		US4	49.70	010403		
		US10	49.70	010377		
		US10A (US11)	62.95	010380		
		US10B	62.95	071584		
		US15	62.95	035721		
		US26	62.95	010385		
		US26D	48.70	010390		
<hr/>						
5" x 4-1/2" (127 mm x 114 mm)			LS	49.70	055246	3
		H2H	78.70	-		
		USP	49.70	010515		
		US3	62.95	010479		
		US4	49.70	010493		
		US10	49.70	010416		
		US10A (US11)	62.95	010429		
		US10B	62.95	010438		
		US15	62.95	010444		
		US26	62.95	010447		
		US26D	48.70	010457		
	<hr/>					
	5" x 5" (127 mm x 127 mm)		LS	49.70	-	3
		H2H	78.70	105812		
		USP	49.70	010620		
		US3	62.93	010586		
		US4	49.70	010602		
		US10	49.70	010537		
		US10A (US11)	62.95	010546		
		US10B	62.95	010556		
		US15	62.95	010559		
		US26	62.95	010564		
		US26D	48.70	010570		





Description	Finish	2021 List	Stock No.	Box Qty.	Case Qty.
BB1279 - Cont. 2	6" x 4-1/2"	LS	118.15	-	3 24
Continued	(152 mm x 114 mm)	H2H	180.05	-	
		USP	118.15	010651	
		US3	158.90	010644	
		US4	118.15	010649	
		US10	118.15	010632	
		US10A (US11)	158.90	009996	
		US10B	158.90	010638	
		US15	158.90	093744	
		US26	158.90	113396	
		US26D	136.45	010641	
<hr/>					
	6" x 5"	LS	118.15	-	3 24
	(152 mm x 127 mm)	H2H	180.05	-	
		USP	118.15	065930	
		US3	158.90	017680	
		US4	118.15	014005	
		US10	118.15	010656	
		US10A (US11)	158.90	010658	
		US10B	158.90	020934	
		US15	158.90	108871	
		US26	158.90	-	
		US26D	136.45	010660	
<hr/>					
	6" x 6"	LS	118.15	-	3 24
	(152 mm x 152 mm)	H2H	180.05	-	
		USP	118.15	010696	
		US3	158.90	010685	
		US4	118.15	010689	
		US10	118.15	010674	
		US10A (US11)	158.90	010677	
		US10B	158.90	068156	
		US15	158.90	043949	
		US26	158.90	010679	
		US26D	136.45	010681	

1. Items with the price in **bold and red** are Quick Ship items and ship in 24 hours.
 Please use stock number when ordering. 2. U/M is each unless otherwise noted.



Commercial Hinges



Description	Finish	2021 List	Stock No.	Box Qty.	Case Qty.
WTBB1279					
Wide Throw	LS	70.20	-	3	24
Steel	USP	67.40	010918		
Full Mortise	US3	85.95	009518		
Standard Weight	US10	70.20	101108		
Ball Bearing	US10A (US11)	85.95	009516		
	US10B	85.95	023424		
	US26	85.95	065499		
	US26D	76.50	011178		
<hr/>					
3-1/2" x 5"	LS	70.20	-	3	24
(89 mm x 127 mm)	USP	67.40	066581		
	US3	85.95	047525		
	US10	70.20	121608		
	US10A (US11)	85.95	132395		
	US10B	85.95	098415		
	US26	85.95	117331		
	US26D	76.50	009523		
<hr/>					
4" x 5"	LS	98.00	-	3	24
(102 mm x 127 mm)	USP	94.65	009537		
	US3	114.20	009531		
	US10	98.00	011977		
	US10A (US11)	114.20	009527		
	US10B	114.20	031902		
	US26	114.20	009684		
	US26D	104.85	092731		
<hr/>					
4" x 6"	LS	98.00	-	3	24
(102 mm x 152 mm)	USP	94.65	009547		
	US3	114.20	009545		
	US10	98.00	014811		
	US10A (US11)	114.20	009540		
	US10B	114.20	006722		
	US26	114.20	022988		
	US26D	104.85	009543		
<hr/>					
4" x 7"	LS	98.00	130408	3	24
(102 mm x 178 mm)	USP	94.65	093245		
	US3	114.20	009552		
	US10	98.00	146515		
	US10A (US11)	114.20	049316		
	US10B	114.20	015456		
	US26	114.20	002586		
	US26D	104.85	009551		



Description	Finish	2021 List	Stock No.	Box Qty.	Case Qty.
WTBB1279 - Cont. Continued	4-1/2" x 5" (114 mm x 127 mm)	LS	93.80	-	3 24
		USP	91.80	009587	
		US3	105.00	009573	
		US10	93.80	009557	
		US10A (US11)	105.00	009559	
		US10B	105.00	009564	
		US26	105.00	009566	
		US26D	98.20	009567	
4-1/2" x 6" (114 mm x 152 mm)	LS	93.80	-	3 24	
	USP	91.80	009629		
	US3	105.00	009613		
	US10	93.80	009591		
	US10A (US11)	105.00	009596		
	US10B	105.00	009600		
	US26	105.00	009601		
	US26D	98.20	009607		
4-1/2" x 7" (114 mm x 178 mm)	USP	98.80	009654	3 24	
	US3	112.85	009644		
	US10	100.95	009636		
	US10A (US11)	112.85	097139		
	US10B	112.85	034974		
	US26D	105.70	009642		
4-1/2" x 8" (114 mm x 203 mm)	USP	98.80	009671	3 24	
	US3	112.85	093992		
	US10	100.95	066950		
	US10A (US11)	112.85	028232		
	US10B	112.85	019076		
	US26D	105.70	009663		
5" x 6" (127 mm x 152 mm)	USP	125.45	049054	3 24	
	US3	156.70	097745		
	US10	131.65	009676		
	US10A (US11)	156.70	019102		
	US10B	156.70	028233		
	US26D	144.20	009683		
5" x 7" (127 mm x 178 mm)	USP	125.45	033635	3 24	
	US3	156.70	021386		
	US10	131.65	009694		
	US10A (US11)	156.70	050575		
	US10B	156.70	030684		
	US26D	144.20	036924		
5" x 8" (127 mm x 203 mm)	USP	125.45	027044	3 24	
	US3	156.70	047665		
	US10	131.65	042602		
	US10A (US11)	156.70	034328		
	US10B	156.70	011281		
	US26D	144.20	094856		

1. Items with the price in **bold and red** are Quick Ship items and ship in 24 hours.
Please use stock number when ordering. 2. U/M is each unless otherwise noted.



Commercial Hinges



Description	Finish	2021 List	Stock No.	Box Qty.	Case Qty.	
1303 Double Acting Spring Hinge	3" (76 mm)	USP	45.30	126803	1	10
		US3	59.75	126804		
		US4	54.80	126805		
		US26D	74.00	126807		
	4" (102 mm)	USP	51.35	126808	1	10
		US3	67.55	126809		
		US4	66.50	126810		
		US26D	83.10	126811		
	5" (127 mm)	USP	73.50	126812	1	10
		US3	99.15	126813		
		US4	109.05	126814		
		US26D	121.50	126815		
6" (152 mm)	USP	73.50	126816	1	10	
	US3	99.15	126817			
	US4	109.05	126818			
	US26D	121.50	126819			
BB1360 Stainless Steel Full Mortise Standard Weight Ball Bearing Swing Clear RH Standard (reversible to LH)	4-1/2" (114 mm)	US32D	228.50	060909	3	36
	5" (127 mm)	US32D	228.50	097565	3	36
BB1361 Stainless Steel Full Mortise Standard Weight Ball Bearing Swing Clear Beveled Edge Doors RH Standard (reversible to LH)	4-1/2" (114 mm)	US32D	228.50	044728	3	36
	5" (127 mm)	US32D	228.50	094295	3	36
BB1362 Stainless Steel Full Mortise Heavy Weight Ball Bearing Swing Clear RH Standard (reversible to LH)	4-1/2" (114 mm)	US32D	256.10	045163	3	24
	5" (127 mm)	US32D	256.10	041420	3	24





Description	Finish	2021 List	Stock No.	Box Qty.	Case Qty.
BB1363					
Stainless Steel	US32D	256.10	042414	3	24
Full Mortise					
Heavy Weight					
Ball Bearing					
Swing Clear					
Beveled Edge Doors					
RH Standard (reversible to LH)					



BB1577		108.55*	-	3	48
Brass or stainless		*Add to price of			
Full Mortise		BB1191			
Standard Weight					
Ball Bearing					
Both Leaves Tapped					



BB1578		108.55*	-	3	48
Brass or stainless		*Add to price of			
Full Mortise		BB1191			
Standard Weight					
Ball Bearing					
One Leaf Tapped					
Specify Handing					



1712	3-1/2" (89 mm)	ALL	59.70	-	10	100
Ball Tip Hinge Kit	4" (102 mm)	ALL	59.70	-	10	100
Standard Weight	4-1/2" (114 mm)	ALL	60.15	-	10	100
	5" (127 mm)	ALL	60.15	-	10	100
	6" (152 mm)	ALL	60.15	-	10	100



1713	4-1/2" (114 mm)	ALL	65.70	-	10	100
Ball Tip Hinge Kit	5" (127 mm)	ALL	65.70	-	10	100
Heavy Weight	6" (152 mm)	ALL	65.70	-	10	100



1716	3-1/2" (89 mm)	ALL	60.15	-	10	100
Acorn Tip Hinge Kit	4" (102 mm)	ALL	60.15	-	10	100
Standard Weight	4-1/2" (114 mm)	ALL	60.15	-	10	100
	5" (127 mm)	ALL	60.15	-	10	100
	6" (152 mm)	ALL	60.15	-	10	100



1717	4-1/2" (114 mm)	ALL	65.70	-	10	100
Acorn Tip Hinge Kit	5" (127 mm)	ALL	65.70	-	10	100
Heavy Weight	6" (152 mm)	ALL	65.70	-	10	100

1. Items with the price in **bold and red** are Quick Ship items and ship in 24 hours.
Please use stock number when ordering. 2. U/M is each unless otherwise noted.



Commercial Hinges



Description	Finish	2021 List	Stock No.	Box Qty.	Case Qty.
1722 Steeple Tip Hinge Kit Standard Weight	3-1/2" (89 mm)	ALL	60.15	-	10 100
	4" (102 mm)	ALL	60.15	-	10 100
	4-1/2" (114 mm)	ALL	60.15	-	10 100
	5" (127 mm)	ALL	60.15	-	10 100
	6" (152 mm)	ALL	60.15	-	10 100



1723 Steeple Tip Hinge Kit Heavy Weight	4-1/2" (114 mm)	ALL	65.70	-	10 100
	5" (127 mm)	ALL	65.70	-	10 100
	6" (152 mm)	ALL	65.70	-	10 100



1728 Urn Tip Hinge Kit Standard Weight	3-1/2" (89 mm)	ALL	60.15	-	10 100
	4" (102 mm)	ALL	60.15	-	10 100
	4-1/2" (114 mm)	ALL	60.15	-	10 100
	5" (127 mm)	ALL	60.15	-	10 100
	6" (152 mm)	ALL	60.15	-	10 100



1729 Urn Tip Hinge Kit Heavy Weight	4-1/2" (114 mm)	ALL	65.70	-	10 100
	5" (127 mm)	ALL	65.70	-	10 100
	6" (152 mm)	ALL	65.70	-	10 100



1850 Steel - Full Surface Heavy Weight Plain Bearing No Holes	4" x 4" (102 mm x 102 mm)	PS	57.60	042562	10 40
	4-1/2" x 4-1/2" (114 mm x 114 mm)	PS	75.45	042564	10 40
	5" x 5" (127 mm x 127 mm)	PS	96.95	042596	1 10
	6" x 6" (152 mm x 152 mm)	PS	144.75	042597	1 10

1850 LP Loose Oval Pin	6" x 6" (152 mm x 152 mm)	PS	144.75	-	1 10
----------------------------------	------------------------------	----	--------	---	------



BB2112 Brass or Stainless Half Surface Standard Weight Ball Bearing	4" (102 mm)	US10	413.30	-	3 48	
		US10B	520.45	028766		
		US26D	447.70	026917		
		US32D	607.05	006867		
	4-1/2" (114 mm)	US10	199.20	012824	3 48	
		US10B	249.00	002499		
		US26D	214.35	012828		
		US32D	290.45	012833		
		5" (127 mm)	US10	210.35	012838	3 36
			US10B	273.45	133233	
US26D	237.85		012839			
US32D	309.20		004041			





Description	Finish	2021 List	Stock No.	Box Qty.	Case Qty.
BB2168					
4-1/2" (114 mm)	USP	314.40	012899	3	36
Steel	US10	327.55	-		
Full Surface	US10A (US11)	383.50	-		
Heavy Weight	US10B	383.50	089570		
Ball Bearing	US26D	343.70	012898		
<hr/>					
5" (127 mm)	USP	379.55	012902	3	24
	US10	398.55	-		
	US10A (US11)	519.35	-		
	US10B	519.35	-		
	US26D	451.65	011313		



BB2169					
4-1/2" (114 mm)	USP	219.90	012914	3	36
Steel	US10	327.60	042983		
Full Surface	US10A (US11)	383.50	061635		
Heavy Weight	US10B	343.70	115013		
Ball Bearing	US26D	338.90	012911		
<hr/>					
5" (127 mm)	USP	338.90	012923	3	24
	US10	355.80	-		
	US10A (US11)	474.75	-		
	US10B	474.75	080993		
	US26D	412.80	012920		



BB2171					
4-1/2" (114 mm)	USP	85.95	012946	3	48
Steel	US10	101.50	012934		
Full Surface	US10A (US11)	129.40	-		
Standard Weight	US10B	129.40	143435		
Ball Bearing	US26D	113.85	012940		
<hr/>					
5" (127 mm)	USP	102.95	012956	3	36
	US10	135.45	026071		
	US10A (US11)	168.10	-		
	US10B	168.10	-		
	US26D	146.15	012952		



AB7001					
4-1/2" (114 mm)	LS	192.00	-	3	36
Steel	USP	192.00	122842		
Full Mortise	US3	236.00	028735		
Standard Weight	US10	199.80	-		
Concealed Anti-Friction Bearing	US10A (US11)	236.00	077050		
Swing Clear	US10B	236.00	008284		
	US26	236.00	-		
	US26D	187.10	024377		
<hr/>					
5" (127 mm)	LS	192.00	-	3	36
	USP	192.00	-		
	US3	236.00	102769		
	US10	199.80	-		
	US10A (US11)	236.00	-		
	US10B	236.00	-		
	US26	236.00	079631		
	US26D	187.10	087869		

1. Items with the price in **bold and red** are Quick Ship items and ship in 24 hours.
Please use stock number when ordering. 2. U/M is each unless otherwise noted.



Commercial Hinges



Description	Finish	2021 List	Stock No.	Box Qty.	Case Qty.
AB7002					
4-1/2" (114 mm)	LS	192.00	-	3	36
Steel	USP	192.00	065541		
Full Mortise	US3	236.00	024690		
Standard Weight	US10	199.80	-		
Concealed Anti-Friction Bearing	US10A (US11)	236.00	103793		
Swing Clear	US10B	236.00	008287		
Beveled Edge Doors	US26	236.00	068502		
	US26D	187.10	094245		
<hr/>					
5" (127 mm)	LS	192.00	-	3	36
	USP	192.00	161148		
	US3	236.00	068098		
	US10	199.80	-		
	US10A (US11)	236.00	-		
	US10B	236.00	-		
	US26	236.00	-		
	US26D	187.10	013655		



AB7501					
4-1/2" (114 mm)	USP	237.60	073850	3	24
Steel	US10	240.90	017299		
Full Mortise	US10A (US11)	289.20	019030		
Heavy Weight	US10B	289.20	122627		
Concealed Anti-Friction Bearing	US26D	219.25	013622		
Swing Clear					
<hr/>					
5" (127 mm)	USP	237.60	-	3	24
	US10	240.90	027631		
	US10A (US11)	289.20	116946		
	US10B	289.20	159182		
	US26D	219.25	013628		







AB7502					
4-1/2" (114 mm)	USP	237.60	041605	3	24
Steel	US10	240.90	025196		
Full Mortise	US10A (US11)	289.20	081770		
Heavy Weight	US10B	289.20	085448		
Concealed Anti-Friction Bearing	US26D	219.25	094244		
Swing Clear					
Beveled Edge Doors					
<hr/>					
5" (127 mm)	USP	237.60	116906	3	24
	US10	240.90	025197		
	US10A (US11)	289.20	094319		
	US10B	289.20	109409		
	US26D	219.25	013645		



AB7505					
5" x 4-1/2"	LH USP	337.95	013659	1	10
(127 mm x 114 mm)	RH USP	337.95	092796		
Steel					
Full Mortise	LH US10	344.40	043893		
Heavy Weight	RH US10	344.40	054740		
Concealed Anti-Friction Bearing	LH US10A (US11)	416.90	013652		
Anchor Hinge	RH US10A (US11)	416.90	-		
Specify Handing	LH US10B	416.90	105739		
	RH US10B	416.90	105740		
	LH US26D	331.80	094710		
	RH US26D	331.80	094711		



	Description	Finish	2021 List	Stock No.	Box Qty.	Case Qty.
	AB7506	5" x 4-1/2"	LH USP	337.95	013684	1
	Steel	(127 mm x 114 mm)	RH USP	337.95	013687	10
	Full Mortise		LH US10	344.40	094813	
	Heavy Weight		RH US10	344.40	093244	
	Concealed Anti-Friction Bearing		LH US10A (US11)	416.90	013664	
	Anchor Hinge		RH US10A (US11)	416.90	112521	
	Specify Handing		LH US10B	416.90	124567	
			RH US10B	416.90	124568	
			LH US26D	331.80	013674	
			RH US26D	331.80	013676	
	AB7507	5" x 4-1/2"	LH USP	337.95	018824	1
	Steel	(127 mm x 114 mm)	RH USP	337.95	071660	10
	Full Mortise		LH US10	344.40	076424	
	Heavy Weight		RH US10	344.40	-	
	Concealed Anti-Friction Bearing		LH US10A (US11)	416.90	-	
	Anchor Hinge		RH US10A (US11)	416.90	-	
	Specify Handing		LH US10B	416.90	100912	
			RH US10B	416.90	100911	
			LH US26D	331.80	013696	
			RH US26D	331.80	096847	
	AB7508	5" x 4-1/2"	LH USP	337.95	013735	1
	Steel	(127 mm x 114 mm)	RH USP	337.95	013736	10
	Full Mortise		LH US10	344.40	016914	
	Heavy Weight		RH US10	344.40	016885	
	Concealed Anti-Friction Bearing		LH US10A (US11)	416.90	013713	
	Anchor Hinge		RH US10A (US11)	416.90	039369	
	Beveled Edge Doors		LH US10B	416.90	096476	
	Specify Handing		RH US10B	416.90	096475	
			LH US26D	324.25	013721	
			RH US26D	324.25	013722	
	AB7509	5" x 4-1/2"	LH USP	337.95	-	1
	Steel	(127 mm x 114 mm)	RH USP	337.95	-	10
	Full Mortise		LH US10	344.40	036585	
	Heavy Weight		RH US10	344.40	036561	
	Concealed Anti-Friction Bearing		LH US10A (US11)	416.90	-	
	Anchor Hinge		RH US10A (US11)	416.90	-	
	Beveled Edge Doors		LH US10B	416.90	059951	
	Specify Handing		RH US10B	416.90	059965	
			LH US26D	331.80	013748	
			RH US26D	331.80	013749	
	AB8505	5" x 4-1/2"	LH US10	353.30	120612	1
	Brass or Stainless	(127 mm x 114 mm)	RH US10	353.30	120613	10
	Full Mortise		LH US10B	423.05	005892	
	Heavy Weight		RH US10B	423.05	005891	
	Concealed Anti-Friction Bearing		LH US26D	335.35	088541	
	Anchor Hinge		RH US26D	335.35	088542	
	Specify Handing		LH US32D	552.30	013976	
			RH US32D	552.30	013977	

1. Items with the price in **bold and red** are Quick Ship items and ship in 24 hours.
Please use stock number when ordering. 2. U/M is each unless otherwise noted.



Commercial Hinges



Description	Finish	2021 List	Stock No.	Box Qty.	Case Qty.	
AB8506	5" x 4-1/2"	LH US10	437.45	038811	1	10
Brass or Stainless	(127 mm x 114 mm)	RH US10	437.45	038812		
Full Mortise		LH US10B	522.95	090057		
Heavy Weight		RH US10B	522.95	090058		
Concealed Anti-Friction Bearing		LH US26D	491.80	013988		
Anchor Hinge		RH US26D	491.80	013990		
Specify Handing		LH US32D	564.25	013996		
		RH US32D	564.25	013998		



AB8507	5" x 4-1/2"	LH US10	437.45	-	1	10
Brass or Stainless	(127 mm x 114 mm)	RH US10	437.45	-		
Full Mortise		LH US10B	522.95	046057		
Heavy Weight		RH US10B	522.95	046058		
Concealed Anti-Friction Bearing		LH US26D	491.20	092729		
Anchor Hinge		RH US26D	491.20	092730		
Beveled Edge Doors		LH US32D	564.25	093601		
Specify Handing`		RH US32D	564.25	094538		



AB8508	5" x 4-1/2"	LH US10	437.45	057002	1	10
Brass or Stainless	(127 mm x 114 mm)	RH US10	437.45	057004		
Full Mortise		LH US10B	522.95	097781		
Heavy Weight		RH US10B	522.95	014016		
Concealed Anti-Friction Bearing		LH US26D	491.20	014019		
Anchor Hinge		RH US26D	491.20	014021		
Beveled Edge Doors		LH US32D	564.25	014028		
Specify Handing		RH US32D	564.25	014030		



AB8509	5" x 4-1/2"	LH US10	437.45	012173	1	10
Brass or Stainless	(127 mm x 114 mm)	RH US10	437.45	012174		
Full Mortise		LH US10B	522.95	046059		
Heavy Weight		RH US10B	522.95	046060		
Concealed Anti-Friction Bearing		LH US26D	491.20	068077		
Anchor Hinge		RH US26D	491.20	022626		
Beveled Edge Doors		LH US32D	564.25	014048		
Specify Handing		RH US32D	564.25	094613		



EC1100*	4-1/2" x 4"	US26D	11.45	121894	3	48
Steel	(114 mm x 102 mm)					
Full Mortise	4-1/2" x 4-1/2"	USP	7.85	079434	3	48
Standard Weight	(114 mm x 114 mm)	US3	14.35	079435		
Plain Bearing		US4	10.40	079441		
		US10B	14.35	075953		
		US15	14.35	108111		
		US26	14.35	108113		
		US26D	11.45	075047		



EC1100 NRP*	4-1/2" x 4"	US26D	13.85	123072	3	48
Steel	(114 mm x 102 mm)					
Full Mortise	4-1/2" x 4-1/2"	USP	10.25	084179	3	48
Standard Weight	(114 mm x 114 mm)	US10B	16.70	075986		
Plain Bearing		US15	16.70	109256		
		US26	16.70	135223		
		US26D	13.85	082934		

* ECCO hinges are sold in box quantities only

* Some ECCO hinges available in 316 Stainless Steel. Contact Hager Companies Sales and Service for information.



Description	Finish	2021 List	Stock No.	Box Qty.	Case Qty.
ECBB1100* Steel Full Mortise Standard Weight Ball Bearing	4-1/2" x 4" (114 mm x 102 mm)	US26D	13.60	094657	3 48
		USP	13.25	079444	3 48
		US3	25.15	079445	
		US4	18.30	079446	
		US10B	25.15	076317	
		US15	25.15	108114	
		US26	25.15	108117	
		US26D	13.20	075048	



ECBB1100 NRP* Steel Full Mortise Standard Weight Ball Bearing	4-1/2" x 4" (114 mm x 102 mm)	US26D	16.00	094659	3 48
		USP	15.60	079448	3 48
		US3	27.55	082125	
		US4	20.70	082129	
		US10B	27.55	076316	
		US26	27.55	109257	
		US26D	15.50	075049	



ECRC1100* Round Corner Steel Full Mortise Standard Weight Plain Bearing	4" x 4" (102 mm x 102 mm)	US15	13.75	109258	3 48
		US26	13.75	-	
		US26D	9.60	075637	



ECRCBB1100* Round Corner Steel Full Mortise Standard Weight Ball Bearing	4" x 4" (102 mm x 102 mm)	US15	17.75	109259	3 48
		US26	17.75	-	
		US26D	13.00	073800	



EC1101* Brass or Stainless Steel Full Mortise Standard Weight Plain Bearing	4-1/2" x 4-1/2" (114 mm x 114 mm)	US15	49.45	128121	3 48
		US26	49.45	125210	
		US32D	47.55	079552	



ECBB1101* Brass or Stainless Steel Full Mortise Standard Weight Ball Bearing	4-1/2" x 4-1/2" (114 mm x 114 mm)	US15	50.05	109275	3 48
		US32D	42.70	079555	

* ECCO hinges are sold in box quantities only

* Other ECCO hinges available in 316 Stainless Steel. Contact Hager Companies Sales and Service for information.



Commercial Hinges



Description	Finish	2021 List	Stock No.	Box Qty.	Case Qty.	
ECBB1101 NRP* Brass or Stainless Steel Full Mortise Standard Weight Ball Bearing	4-1/2" x 4-1/2" (114 mm x 114 mm)	US15 52.35 US32D 45.15	109276 079557	3	48	
		US32D/316SS 71.85	-			
ECBB1102* Steel Full Mortise Heavy Weight Ball Bearing	4-1/2" x 4-1/2" (114 mm x 114 mm)	USP 28.60 US15 59.50 US26 59.50 US26D 35.45	091900 109284 119967 091783	3	24	
	5" x 4-1/2" (127 mm x 114 mm)	US15 61.70 US26 61.70 US26D 41.65	130049 140126 091638	3	24	
	ECBB1102 NRP* Steel Full Mortise Heavy Weight Ball Bearing	4-1/2" x 4-1/2" (114 mm x 114 mm)	USP 30.70 US15 61.95 US26 61.95 US26D 37.85	091866 109608 127835 091778	3	24
		5" x 4-1/2" (127 mm x 114 mm)	US15 64.10 US26 64.10 US26D 44.05	132673 125212 091618	3	24
	ECBB1103* Brass or Stainless Steel Full Mortise Heavy Weight Ball Bearing	4-1/2" x 4-1/2" (114 mm x 114 mm)	US10B 110.95 US15 110.95 US26 110.95 US32D 102.15	091741 129146 138809 091731	3	24
5" x 4-1/2" (127 mm x 114 mm)		US15 135.15 US26 135.15 US32D 130.75	- - 091592	3	24	
ECBB1103 NRP* Brass or Stainless Steel Full Mortise Heavy Weight Ball Bearing		4-1/2" x 4-1/2" (114 mm x 114 mm)	US10B 113.35 US26 113.35 US32D 104.55	091732 - 091693	3	24
		5" x 4-1/2" (127 mm x 114 mm)	US32D/316SS 149.85 US15 137.50 US26 137.50 US32D 133.15	169967 - - 091593	3	24
EC1105* Steel Full Mortise Standard Weight Spring Hinge	4-1/2" x 4-1/2" (114 mm x 114 mm)	USP 22.75 US3 46.35 US4 40.45 US10B 46.35 US15 46.35 US26 46.35 US26D 34.10	079571 079569 079570 076318 109281 109282 079567	3	48	

* ECCO hinges are sold in box quantities only

* Other ECCO hinges available in 316 Stainless Steel. Contact Hager Companies Sales and Service for information.



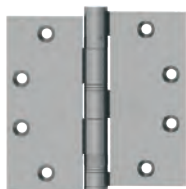

Description	Finish	2021 List	Stock No.	Box Qty.	Case Qty.
BB1279 Drop Leaf Steel Full Mortise Standard Weight Ball Bearing NRP Standard Specify handing		4-1/2" x 4-1/2"	US26D	81.05	
BB1168 Drop Leaf Steel Full Mortise Heavy Weight Ball Bearing NRP Standard Specify handing		4-1/2" x 4-1/2"	US26D	129.85	
BB1191 Drop Leaf Stainless Steel Full Mortise Heavy Weight Ball Bearing NRP Standard Specify handing		4-1/2" x 4-1/2"	US32D	172.55	
BB1199 Drop Leaf Stainless Steel Full Mortise Heavy Weight Ball Bearing NRP Standard Specify handing		4-1/2" x 4-1/2"	US32D	258.10	
BB1279 Short Leaf Steel Full Mortise Standard Weight Ball Bearing Right Hand Standard Reversible to Left Hand		4-1/2" x 4-3/8"	US26D	81.05	
BB1168 Short Leaf Steel Full Mortise Heavy Weight Ball Bearing Right Hand Standard Reversible to Left Hand		4-1/2" x 4-3/8"	US26D	129.85	
BB1191 Short Leaf Stainless Steel Full Mortise Standard Weight Ball Bearing Right Hand Standard Reversible to Left Hand		4-1/2" x 4-3/8"	US32D	172.55	



1. Items with the price in **bold and red** are Quick Ship items and ship in 24 hours.
Please use stock number when ordering. 2. U/M is each unless otherwise noted.



Commercial Hinges



Description	Finish	2021 List	Stock No.	Box Qty.	Case Qty.
BB1199 Short Leaf Stainless Steel Full Mortise Standard Weight Ball Bearing Right Hand Standard Reversible to Left Hand *NRP available upon request		4-1/2" x 4-3/8"	US32D	258.10	
BB1279 Unequal Leaf Centered Steel Full Mortise Standard Weight Ball Bearing NRP Standard Specify handing		5" x 4-1/2"	US26D	125.05	
BB1168 Unequal Leaf Centered Steel Full Mortise Heavy Weight Ball Bearing NRP Standard Specify handing		5" x 4-1/2"	US26D	177.10	
BB1191 Unequal Leaf Centered Stainless Steel Full Mortise Heavy Weight Ball Bearing NRP Standard Specify handing		5" x 4-1/2"	US32D	220.90	
BB1199 Unequal Leaf Centered Stainless Steel Full Mortise Heavy Weight Ball Bearing NRP Standard Specify handing		5" x 4-1/2"	US32D	323.25	

*Additional sizes, finishes, and hinges available. Contact Hager Customer Service for information.





H **HAGER**[®]
COMPANIES

TABLE OF CONTENTS

B	
Barn Door Hardware	
eConestoga Series Barn Door Hardware	20
Barn Door Privacy Lock.....	21
D	
Discount Groups	3
F	
Fast Riveted Pin.....	16
Finish	2
M	
Machine Screws	4
N	
Non-Removable Pin (Set Screw in Barrel).....	2
P	
Pins - Residential and Decorative Tips.....	19
R	
Residential Finish Symbols	2
S	
Safety Stud	13, 15, 19
Solid Brass or Stainless Steel.....	4-6, 11-12
Spring	6, 9-12
T	
Template Hinges.....	6, 9
W	
Wood Screws.....	17



Residential Hinges

RESIDENTIAL FINISH SYMBOLS

Not all products are available in all finishes. Contact Hager Sales and Service at 1-800-325-9995 for more specific information.

Non-Removable Pins (Medium Security)

Symbol	Description	List
NRP	Set screw in barrel	\$2.65 each

BHMA Symbol Base Material

US & HAGER	DESCRIPTION	STEEL	BRASS	STAINLESS STEEL
1D	Black	N/A	N/A	N/A
2D	Brass Tone Dichromate	N/A	N/A	N/A
3	Bright Brass	632	605	N/A
3LB	Light Brass	N/A	N/A	N/A
4	Satin Brass	633	606	N/A
10A	Antique Bronze - Lacquered	641	614	N/A
10R	Dark Antique Bronze - Matte Lacquer	N/A	N/A	N/A
15	Satin Nickel	646	619	N/A
26	Bright Chromium Plated	651	625	N/A
26D	Satin Chromium Plated	652	626	N/A
32	Stainless Steel Metal, Bright	N/A	N/A	629
32D	Stainless Steel Metal, Satin	N/A	N/A	630
P	Prime Coat - Beige	600	600	N/A
ABA/US5	Antique Brass	638	609	N/A
AN/15A	Antique Nickel	647	620	N/A

Note: For any finish not listed in this Price Book, price and availability on request.

LEAD TIMES

Items with prices in **bold** within this section are stock items and usually ship within 24 hours. Non-stock items will typically ship within 90 business days depending on seasonal volume and order complexity. The anticipated ship date will be included with each order acknowledgment.



RESIDENTIAL DISCOUNT GROUPS

GROUP	DESCRIPTION	DISC %
BB1541 - RCBB1541 - RCBB1542 (3.5)		
80M	3.5 - SS BB (32-32D)	_____
1741 - RC1741 - RC1842 (3.0, 3.5)		
81A	3.0, 3.5 - PB BOX (10A-ABA-AN-1D-26-26D-3)	_____
81C	3.0, 3.5 - PB BOX (10R-15)	_____
81G	3.0, 3.5 - PB BOX (2D-4-P-3LB)	_____
BB1741 - RCBB1741 - RCBB1842 (3.5)		
82A	3.5 - BB BOX (10A-ABA-AN-10R-1D-15-26-26D-3)	_____
82G	3.5 - BB BOX (2D-4-3LB)	_____
RC1641 - RC1841 - 7741 - 8741 (3.5)		
83A	3.5 - BULK (10A-ABA-AN-1D-26-26D-3)	_____
83C	3.5 - BULK (10R-15)	_____
83G	3.5 - BULK (2D-4-P-3LB)	_____
1541 - RC1541 - RC1542 (3.0, 3.5)		
86A	3.0, 3.5 - BRASS (10A-ABA-AN-10R-15-26-26D-3)	_____
86G	3.0, 3.5 - BRASS (4)	_____
86M	3.0, 3.5 - SS (32-32D)	_____
1750 - 1751 - 1752 (3.5)		
87A	3.5 - SPRING (10A-ABA-AN-1D-10R-15-26-26D-3)	_____
87G	3.5 - SPRING (2D-4-P-3LB)	_____
RC1748 (3.5)		
88A	3.5 - RC1748 (10A-ABA-AN-15-26-26D-3)	_____
88G	3.5 - RC1748 (2D-4-P-3LB)	_____
RCBB1841 (3.5)		
8CA	3.5 - BB BULK (AN-15-3-10R-26-26D-5)	_____
8CG	3.5 - BB BULK (2D-4)	_____
BB1543 (4.0)		
90A	4.0 - BRASS BB (10R-3-ABA-AN)	_____
90G	4.0 - BRASS BB (4)	_____
90M	4.0 - SS BB (32-32D)	_____

RCBB1841 (4.0)		
9CA	4.0 - BB BULK (10R-15)	_____

GROUP	DESCRIPTION	DISC %
1741 - RC1741 - 1842 (4.0)		
91A	4.0 - PB BOX (10A-ABA-AN-10R-1D-15-26-26D-H2H)	_____
91C	4.0 - PB BOX (10R-15)	_____
91G	4.0 - PB BOX (2D-4-P-3LB)	_____
RCBB1741 - RCBB1842 (4.0)		
92A	4.0 - BB BOX (10A-ABA-AN-10R-1D-26-26D-3)	_____
92G	4.0 - BB BOX (2D-4-P-3LB)	_____
RC1641 - RC1841 - RC8641 - RC8741 - RC8744 (4.0)		
93A	4.0 - BULK (10A-ABA-AN-1D-26-26D-3)	_____
93C	4.0 - BULK (10R - 15)	_____
93G	4.0 - BULK (2D-4-P-3LB)	_____
RC1542 - 1541 - RC1541 - RC1543 (4.0)		
96A	4.0 - BRASS (ABA-AN-10R-15-26-26D-3)	_____
96M	4.0 - SS (32-32D)	_____
1744 - 1750 - 1751 - 1752 - 1754 - 1760 - 1761 - 1762 - 1764 (4.0)		
97A	4.0 SPRING (10A-ABA-AN-10R-1D-15-26-26D-3)	_____
97G	4.0 SPRING (2D-4-P-3LB)	_____
97M	4.0 SPRING (32-32D)	_____
RC1749 (4.0)		
99A	4.0 - RC1749 (10A-ABA-15-26-26D-3-4-L2)	_____
99G	4.0 - RC1749 (2D-4-P-3LB)	_____
RC1846 - RC1847 (4.0)		
9AA	4.0 - FRP BOX (3)	_____
9AG	4.0 - FRP BOX (2D-P)	_____
RC1846 - RC1847 (4.0)		
9BA	4.0 - FRP BULK (10A-10R-ABA-AN-1D-3-15-26D)	_____
9BG	4.0 - FRP BULK (2D-P)	_____
RC1843 (4.0)		
9DA	4.0 - SECURITY BOX (10A-ABA-AN-15-26D-3-10R-26)	_____
9DG	4.0 - SECURITY BOX (2D-4)	_____
RC1843 (4.0)		
9EA	4.0 - SECURITY BULK (10R-15-26-26D-3-ABA-AN)	_____
9EG	4.0 - SECURITY BULK (2D-P-3LB)	_____
OTHER GROUP CODES		
701	RESIDENTIAL BULK SCREWS	_____
780	RESIDENTIAL AUXILIARY	_____



Residential Hinges



Description	Finish	2021 List	Stock No.	Box Qty.	Case Qty.	Disc. Code
1340 Machine Screws UM - Pack of 400	10-24 x 1/2" FPHM with #9 Head	USP 34.64	095782	1 pack	10 packs	701
		2D 34.64	095781			
		US3 34.64	095791			
		3LB 34.64	095792			
		US4 34.64	095795			
		ABA/US5 34.64	095796			
		10R 34.64	095784			
		US15 34.64	095785			
		US26 34.64	095788			
		US26D 34.64	095789			
 1541 Solid Brass or Stainless Square Corner Full Mortise Residential Wt. Plain Bearing with Screws U/M - 1 each	3-1/2" x 3-1/2" (89 mm x 89 mm)	US3 15.70	030141	2 each	100 each	86A
		10R 15.70	032855			86A
		US15 15.70	031539			86A
		US32 16.01	030144			86M
		US32D 16.01	030146			86M
	4" x 4" (102 mm x 102 mm)	US3 18.25	030149	2 each	50 each	96A
		10R 18.25	033204			96A
		US15 18.25	035737			96A
		US32 18.56	030152			96M
		US32D 18.56	030153			96M
 BB1541 Stainless Square Corner Full Mortise Residential Wt. Ball Bearing with Screws U/M - 1 each	3-1/2" x 3-1/2" (89 mm x 89 mm)	US32D 20.87	034377	2 each	100 each	80M
	4" x 4" (102 mm x 102 mm)	US32D 23.05	034534	2 each	50 each	90M
 RC1541 Solid Brass or Stainless 1/4" Radius Round Corner Full Mortise Residential Weight Plain Bearing with Screws U/M - 1 each	3-1/2" x 3-1/2" (89 mm x 89 mm)	US3 15.70	030229	2 each	100 each	86A
		10R 15.70	034358			86A
		US15 15.70	033818			86A
		US26 15.70	030212			86A
		US26D 15.70	030227			86A
		US32D 16.01	030232			86M
	4" x 4" (102 mm x 102 mm)	US3 18.25	033004	2 each	50 each	96A
		10R 18.25	035343			96A
		US15 18.25	034837			96A
		US26 18.25	033001			96A
	US26D 18.25	033003			96A	
	US32D 18.56	033008			96M	
 RCBB1541 Stainless 1/4" Radius Full Mortise Residential Wt. Ball Bearing with Screws U/M - 1 each	3-1/2" x 3-1/2" (89 mm x 89 mm)	US32D 20.87	034378	2 each	100 each	80M
	4" x 4" (102 mm x 102 mm)	US32D 23.05	034587	2 each	50 each	90M





Description	Finish	2021 List	Stock No.	Box Qty.	Case Qty.	Disc. Code		
RC1542 Solid Brass or Stainless 5/8" Radius Round Corner Full Mortise Residential Wt. Plain Bearing with Screws U/M - 1 each	3-1/2" x 3-1/2" (89 mm x 89 mm)	US3	15.70	030276	2 each	100 each	86A	
		US4	15.70	030291			86G	
		10R	15.70	036081			86A	
		US15	15.70	035594			86A	
		US26	15.70	030273			86A	
		US26D	15.70	030275			86A	
		US32	16.01	030288			86M	
		US32D	16.01	030289			86M	
		4" x 4" (102 mm x 102 mm)	US3	18.25	033051	2 each	50 each	96A
			10R	18.25	036761			96A
		US15	18.25	035743			96A	
		US26D	18.25	033050			96A	
		US32	18.56	033053			96M	
		US32D	18.56	033056			96M	
RCBB1542 Stainless 5/8" Radius Round Corner Full Mortise Residential Wt. Ball Bearing with Screws U/M - 1 each	3-1/2" x 3-1/2" (89 mm x 89 mm)	US32D	20.87	034381	2 each	100 each	80M	
	4" x 4" (102 mm x 102 mm)	US32D	23.05	034589	2 each	50 each	90M	
1543 Solid Brass or Stainless Square by 5/8" Radius Full Mortise Residential Wt. Plain Bearing with Screws U/M - 1 each	4" x 4" (102 mm x 102 mm)	US3	18.25	071461	2 each	50 each	96A	
		10R	18.25	036911			96A	
		US15	18.25	071462			96A	
		US32D	18.56	071531			96M	
BB1543 Solid Brass or Stainless Square by 5/8" Radius Full Mortise Residential Wt. Ball Bearing with Screws U/M - 1 each	4" x 4" (102 mm x 102 mm)	US3	23.48	071637	2 each	50 each	90A	
		10R	23.48	036980			90A	
		US32D	23.48	071552			90M	
1734 Stainless Steel 1/4" Radius Round Corner Full Mortise Spring Hinge Template Timely Frame All MS 1/2 WS U/M - 1 each	4" x 4" (102 mm x 102 mm)	US32D	46.60	169906	2 each	80 each	97M	



1. Items with prices in **bold** are stock items and usually ship within 24 hours. Please use stock number when ordering.
 2. Minimum order quantity is one box unless otherwise noted.



Residential Hinges



Description	Finish	2021 List	Stock No.	Box Qty.	Case Qty.	Disc. Code		
1741 Steel Square Corner Full Mortise Residential Wt. Plain Bearing - with Screws U/M - 1 each	3" x 3" (76 mm x 76 mm)	USP	2.24	029648	2 each	100 each	81G	
		2D	2.24	029641			81G	
		US3	6.42	033133			81A	
		US4	2.24	029645			81A	
		US10A	6.42	033129			81A	
		US26	6.42	033131			81A	
		US26D	6.42	033132			81A	
		3-1/2" x 3-1/2" (89 mm x 89 mm)	USP	2.24	029661	2 each	100 each	81G
		1D	6.42	030556			81A	
		2D	2.24	029658			81G	
		US3	6.42	030533			81A	
		3LB	2.24	029660			81G	
		US4	2.24	029659			81G	
	ABA/US5	6.42	030552			81A		
	US10A	6.42	030548			81A		
	10R	6.42	037124			81C		
	US15	6.42	030555			81C		
	AN/US15A	6.42	030620			81A		
	US26	6.42	030547			81A		
	US26D	6.42	030551			81A		
4" x 4" (102 mm x 102 mm)	USP	3.30	029667	2 each	50 each	91G		
	1D	7.60	033144			91A		
	2D	3.30	029662			91G		
	US3	7.60	033148			91A		
	US4	3.30	029664			91G		
	ABA/US5	7.60	033197			91A		
	US10A	7.60	033141			91A		
	10R	7.60	038067			91C		
	US15	7.60	032829			91C		
	AN/US15A	7.60	033199			91A		
	US26	7.60	033145			91A		
	US26D	7.60	033146			91A		
	BB1741 Steel Square Corner Ball Bearing Hinges Full Mortise Residential Wt. with Screws U/M - 1 each	(89 mm x 89 mm)	US3	10.78	034274	2 each	100 each	82A
		US4	6.60	034337			82G	
		ABA/US5	6.60	034332			82A	
		US10A	10.78	034330			82A	
		10R	10.78	040217			82A	
		US15	10.78	034333			82A	
		AN/US15A	10.78	034334			82A	
		US26	10.78	034275			82A	
		US26D	10.78	034329			82A	
		4" x 4" (102 mm x 102 mm)	2D	7.66	034500	2 each	50 each	92G
		US3	11.90	034474			92A	
		US4	7.66	034502			92G	
		ABA/US5	11.90	034497			92A	
	US10A	11.90	034483			92A		
	10R	11.90	040724			92A		
	US15	11.90	034498			92A		
	AN/US15A	11.90	034499			92A		
	US26	11.90	034477			92A		
	US26D	11.90	034482			92A		





Description	Finish	2021 List	Stock No.	Box Qty.	Case Qty.	Disc. Code
RC1741						
Steel	USP	2.24	029677	2 each	100 each	81G
1/4" Radius	2D	2.24	029673			81G
Round Corner	US3	6.42	033512			81A
Full Mortise	US4	2.24	029675			81G
Residential Wt.	US26D	6.42	032859			81A
Plain Bearing with screws						
U/M - 1 each						
3-1/2" x 3-1/2"	USP	2.24	029683	2 each	100 each	81G
(89 mm x 89 mm)	1D	6.42	030680			81A
	2D	2.24	029678			81G
	US3	6.42	030644			81A
	3LB	2.24	029475			81G
	US4	2.24	029681			81G
	ABA/US5	6.42	030648			81A
	US10A	6.42	030645			81A
	10R	6.42	041116			81C
	US15	6.42	030652			81C
	AN/US15A	6.42	030689			81A
	US26	6.42	030646			81A
	US26D	6.42	030647			81A
4" x 4"	USP	3.30	029707	2 each	50 each	91G
(102 mm x 102 mm)	1D	7.60	032881			91A
	2D	3.30	029695			91G
	US3	7.60	033267			91A
	US4	3.30	029698			91G
	ABA/US5	7.60	033523			91A
	US10A	7.60	033514			91A
	10R	7.60	041269			91C
	US15	7.60	032876			91C
	AN/US15A	7.60	032882			91A
	US26	7.60	033262			91A
	US26D	7.60	033265			91A

1. Items with prices in **bold** are stock items and usually ship within 24 hours. Please use stock number when ordering.
2. Minimum order quantity is one box unless otherwise noted.



Residential Hinges



Description	Finish	2021 List	Stock No.	Box Qty.	Case Qty.	Disc. Code		
RC1741 Steel 1/4" Radius Round Corner Full Mortise Residential Wt. Plain Bearing Bulk Assembled See style #2617 & #2817 for screws U/M - Each - Bulk	3-1/2" x 3-1/2" (89 mm x 89 mm)	USP	2.06	067018	-	100 each	83G	
		1D	5.92	073575			83A	
		2D	2.06	029472			83G	
		US3	5.92	073573			83A	
		3LB	2.06	029682			83G	
		US4	2.06	071720			83G	
		ABA/US5	5.92	030715			83A	
		10R	5.92	073577			83C	
		US15	5.92	069005			83C	
		AN/US15A	5.92	030716			83A	
		US26	5.92	067027			83A	
		US26D	5.92	073572			83A	
	4" x 4" (102 mm x 102 mm)	USP	2.99	060651	-	100 each	93G	
		1D	6.98	060662			93A	
		2D	2.99	029565			93G	
US3		6.98	060657			93A		
3LB		2.99	029568			93G		
US4		2.99	068179			93G		
US10A		6.98	033600			93A		
10R		6.98	040444			93C		
US15		6.98	068996			93C		
AN/US15A		6.98	081352			93A		
US26		6.98	060654			93A		
US26D		6.98	073499			93A		
RCBB1741 Steel 1/4" Radius Round Corner Full Mortise Residential Wt. Ball Bearing with screws U/M - 1 each		3-1/2" x 3-1/2" (89 mm x 89 mm)	1D	10.78	079451	2 each	100 each	82A
			US3	10.78	034346			82A
			US4	6.60	034361			82G
		ABA/US5	10.78	034352			82A	
		10R	10.78	038241			82A	
		US15	10.78	034353			82A	
		AN/US15A	10.78	034355			82A	
		US26	10.78	034348			82A	
		US26D	10.78	034349			82A	
	4" x 4" (102 mm x 102 mm)	1D	11.90	079453	2 each	50 each	92G	
		2D	7.66	034512			92G	
		US3	11.90	034504			92A	
		US4	7.66	034514			92G	
		ABA/US5	11.90	034509			92A	
		US10A	11.90	034508			92A	
10R		11.90	040073			92A		
US15		11.90	034510			92A		
AN/US15A		11.90	034511			92A		
US26		11.90	034506			92A		
US26D	11.90	034507			92A			





Description	Finish	2021 List	Stock No.	Box Qty.	Case Qty.	Disc. Code		
1744 Steel 1/4" Radius Round Corner Full Mortise Residential Wt. Spring Hinge Template All MS - 1/2 WS U/M - 1 each	4" x 4" (102 mm x 102 mm)	USP	19.75	169928	2 each	80 each	97G	
		2D	19.75	169912			97G	
		US3	32.33	169913			97A	
		US4	19.75	169915			97A	
		ABA/US5	32.33	169917			97A	
		US10A	32.33	169907			97A	
		US26	32.33	169909			97A	
		US26D	32.33	169911			97A	
	RC1748 Steel 1/4" Radius Round Corner Full Mortise Residential Wt. Plain Bearing Template All MS - 1/2 WS U/M - 1 each	3-1/2" x 3-1/2" (89 mm x 89 mm)	2D	2.37	029724	2 each	100 each	88G
			US3	6.42	030693			88A
		US4	2.37	029725			88G	
		US10A	6.42	030698			88A	
		10R	6.42	016929			88A	
		US15	6.42	016936			88A	
		US26	6.42	030699			88A	
		US26D	6.42	030695			88A	
RC1749 Steel 1/4" Radius Round Corner Full Mortise Residential Wt. Plain Bearing Template AMS - 1/2 WS U/M - 1 each		4" x 4" (102 mm x 102 mm)	2D	4.86	029731	3 each	48 each	99G
			US3	7.60	033529			99A
		3LB	4.86	029734			99G	
		US4	4.86	029732			99G	
		ABA/US5	7.60	032889			99A	
		US10A	7.60	032887			99A	
		10R	7.60	016902			99A	
		US15	7.60	016897			99A	
		US26	7.60	033524			99A	
		US26D	7.60	033528			99A	
1750 Steel Square Corner Full Mortise Residential Wt. Spring Hinge with Screws ALL WS U/M - 1 each	3-1/2" x 3-1/2" (89 mm x 89 mm)	USP	18.44	170018	2 each	80 each	87G	
		1D	24.54	169977			87G	
		2D	18.44	169982			87G	
		US3	24.54	169983			87A	
		3LB	18.44	169986			87G	
		US4	18.44	169985			87G	
		ABA/US5	24.54	169988			87A	
		10R	24.54	169973			87A	
		US15	24.54	169974			87A	
		AN/US15A	24.54	170017			87A	
		US26	24.54	169979			87A	
		US26D	24.54	169981			87A	
	4" x 4" (102 mm x 102 mm)	USP	19.75	170046	2 each	80 each	97G	
		2D	19.75	170033			97G	
		US3	32.33	170035			97A	
3LB		19.75	170037			97G		
US4		19.75	170040			97G		
ABA/US5		32.33	170043			97A		
10R		32.33	170020			97A		
US15		32.33	170021			97A		
AN/US15A		32.33	170044			97A		
US26		32.33	170023			97A		
US26D	32.33	170031			97A			

1. Items with prices in **bold** are stock items and usually ship within 24 hours. Please use stock number when ordering.
 2. Minimum order quantity is one box unless otherwise noted.



Residential Hinges



Description	Finish	2021 List	Stock No.	Box Qty.	Case Qty.	Disc. Code	
1751 Steel 1/4" Radius Round Corner Full Mortise Residential Wt. Spring Hinge with Screws ALL WS U/M - 1 each	3-1/2" x 3-1/2" (89 mm x 89 mm)	1D	24.54	170204	2 each	80 each	87A
		2D	18.44	170206			87G
		US3	24.54	170207			87A
		3LB	18.44	031065			
		US4	18.44	170215			87G
		ABA/US5	24.54	170217			87A
		10R	24.54	170202			87A
		US15	24.54	170203			87A
		AN/US15A	24.54	170218			87A
		US26D	24.54	170205			87A
	4" x 4" (102 mm x 102 mm)	USP	19.75	170239	2 each	80 each	97G
		1D	32.33	170226			97A
		2D	19.75	170230			97G
		US3	32.33	170233			97A
3LB		19.75	170234			97G	
US4		19.75	170235			97G	
US10A		32.33	170223			97A	
ABA/US5		32.33	170236				
10R		32.33	170224			97A	
US15		32.33	170225			97A	
AN/US15A		32.33	170237			97A	
US26		32.33	170228			97A	
US26D		32.33	170229			97A	
1752 Steel 5/8" Radius Round Corner Full Mortise Residential Wt. Spring Hinge with Screws ALL WS U/M - 1 each		3-1/2" x 3-1/2" (89 mm x 89mm)	USP	18.44	170428	2 each	80 each
		1D	24.54	170245			87A
		2D	18.44	170418			87G
		US3	24.54	170419			87A
		3LB	18.44	170420			87G
		US4	18.44	170421			87G
		US10A	24.54	24.54			
		ABA/US5	24.54	170423			87A
		10R	24.54	170243			87A
		US15	24.54	170244			87A
		AN/US15A	24.54	170427			87A
		US26	24.54	170246			87A
		US26D	24.54	170417			87A
	4" x 4" (102 mm x 102 mm)	USP	19.75	170480	2 each	80 each	97G
1D		32.33	170453			97A	
2D		19.75	170457			97G	
US3		32.33	170458			97A	
3LB		19.75	170459			97G	
US4		19.75	170460			97G	
ABA/US5		32.33	170461			97A	
US10A		32.33	170430			97A	
10R		32.33	170451			97A	
US15		32.33	170452			97A	
AN/US15A		32.33	170479			97A	
US26		32.33	170454			97A	
US26D		32.33	170455			97A	



1. Items with prices in **bold** are stock items and usually ship within 24 hours. Please use stock number when ordering.
2. Minimum order quantity is one box unless otherwise noted.



Description	Finish	2021 List	Stock No.	Box Qty.	Case Qty.	Disc. Code
1754 Steel 4" x 4" (102 mm x 102 mm) Square by 5/8" Radius Full Mortise Residential Wt. Spring Hinge with Screws ALL WS U/M - 1 each	USP	19.75	170494	2 each	80 each	97G
	1D	32.33	170483			97G
	2D	19.75	170486			97G
	US3	32.33	170487			97A
	3LB	19.75	170488			97G
	US4	19.75	170489			97A
	ABA/US5	32.33	170490			97G
	10R	32.33	170481			97A
	US15	32.33	170482			97A
	AN/US15A	32.33	170491			97A
	US26	32.33	170484			97A
	US26D	32.33	170485			97A
1760 Stainless Steel 4" x 4" (102 mm x 102 mm) Square Corner Full Mortise Residential Wt. Spring Hinge with Screws ALL WS U/M - 1 each	US32	46.60	170495	2 each	80 each	97M
	US32D	46.60	170497			
1761 Stainless Steel 4" x 4" (102 mm x 102 mm) 1/4" Radius Round Corner Full Mortise Residential Wt. Spring Hinge with Screws ALL WS U/M - 1 each	US32	46.60	170513	2 each	80 each	97M
	US32D	46.60	170514			
1762 Stainless Steel 4" x 4" (102 mm x 102 mm) 5/8" Radius Round Corner Full Mortise Residential Wt. Spring Hinge with Screws ALL WS U/M - 1 each	US32	46.60	170515	2 each	80 each	97M
	US32D	46.60	170516			
1764 Stainless Steel 4" x 4" (102 mm x 102 mm) Square by 5/8" Radius Full Mortise Residential Wt. Spring Hinge with Screws ALL WS U/M - 1 each	US32	46.60	170517	2 each	80 each	97M
	US32D	46.60	170519			

1. Items with prices in **bold** are stock items and usually ship within 24 hours. Please use stock number when ordering.
2. Minimum order quantity is one box unless otherwise noted.



Residential Hinges



Description	Finish	2021 List	Stock No.	Box Qty.	Case Qty.	Disc. Code	
1816	4" x 4"	USP	2.99	060616	-	100 each	93G
Steel	(102 mm x 102 mm)	1D	6.98	073488			93A
Square by 5/8" Radius		2D	2.99	071716			93G
Full Mortise		US3	6.98	060622			93A
Residential Wt.		3LB	2.99	071713			93G
Plain Bearing		ABA/US5	6.98	060623			93A
Bulk Assembled Right Hand		10R	6.98	040441			93C
		US15	6.98	073492			93C
U/M - Each - Bulk		AN/US15A	6.98	060619			93A
		US26	6.98	060642			93A
		US26D	6.98	073483			93A



BB1816	4" x 4"	US3	11.90	070306	2 each	50 each	92A
Steel	(102 mm x 102 mm)	US4	7.66	070312			92G
Square by 5/8" Radius		ABA/US5	11.90	070258			92A
Full Mortise		10R	11.90	041717			92A
Residential Wt.		US15	11.90	070289			92A
Ball Bearing with screws		AN/US15A	11.90	070273			92A
Right Hand		US26D	11.90	070311			92A
U/M - 1 each							



1817	4" x 4"	USP	2.99	071685	-	100 each	93G
Steel	(102 mm x 102 mm)	1D	6.98	073477			93A
Square by 5/8" Radius		2D	2.99	071690			93G
Full Mortise		US3	6.98	060608			93A
Residential Wt.		3LB	2.99	071691			93G
Plain Bearing		10R	6.98	073484			93C
Bulk Assembled Left Hand		US15	6.98	073476			93C
See style #2817 for Screws		AN/US15A	6.98	073450			93A
U/M - Each - Bulk		US26D	6.98	073452			93A



BB1817		2D	7.66	070498	2 each	50 each	
Steel	4" x 4"	US3	11.90	070604			92A
Square by 5/8" Radius	(102 mm x 102 mm)	US4	7.66	070612			92G
Full Mortise		ABA/US5	11.90	070534			92A
Residential Wt.		10R	11.90	041720			92A
Ball Bearing with screws		US15	11.90	070562			92A
Left Hand		AN/US15A	11.90	070556			92A
U/M - 1 each		US26D	11.90	070580			92A



1818	4" x 4"	USP	4.30	071677	-	100 each	9EG
Steel	(102 mm x 102 mm)	3LB	4.30	071686			9EG
Square by 5/8" Radius		US4	4.30	060605			
Full Mortise		US15	9.47	073447			9EA
Residential Wt.		AN/US15A	9.47	073445			9EA
Plain Bearing		US26D	9.47	073444			9EA
Bulk Assembled Right Hand							
Safety Stud							
See style #2817 for screws							
U/M - Each - Bulk							



Description	Finish	2021 List	Stock No.	Box Qty.	Case Qty.	Disc. Code	
1819	4" x 4"	USP	4.30	071679	-	100 each	9EG
Steel	(102 mm x 102 mm)	3LB	4.30	071678			9EG
Square by 5/8" Radius		10R	9.47	040435			9EA
Full Mortise		US15	9.47	060606			9EA
Residential Wt.		US26D	9.47	073439			9EA
Plain Bearing							
Bulk Assembled Left Hand							
Safety Stud							
See style #2817 for screws							
U/M - Each - Bulk							
RC1841	3-1/2" x 3-1/2"	USP	2.06	071673	-	100 each	83G
Steel	(89 mm x 89 mm)	1D	5.92	073341			83A
5/8" Radius		2D	2.06	071680			83G
Round Corner		US3	5.92	073313			83A
Full Mortise		3LB	2.06	071681			83G
Residential Wt.		US4	2.06	071675			83G
Plain Bearing		ABA/US5	5.92	073195			83A
Bulk Assembled with Screws		US10A	5.92	073410			83A
See style #2617 & #2817 for screws		10R	5.92	040429			83C
U/M - Each - Bulk		US15	5.92	073344			83C
		AN/US15A	5.92	073191			83A
		US26	5.92	073332			83A
		US26D	5.92	073323			83A
	4" x 4"	USP	2.99	071639	-	100 each	93G
	(102 mm x 102 mm)	1D	6.98	073188			93A
		2D	2.99	071671			93G
		US3	6.98	073174			93A
		3LB	2.99	071649			93G
		US4	2.99	071642			93G
		ABA/US5	6.98	073168			93A
		US10A	6.98	073192			93A
		10R	6.98	073186			93C
		US15	6.98	073187			93C
		AN/US15A	6.98	033565			93A
		US26	6.98	073189			93A
		US26D	6.98	073181			93A

1. Items with prices in **bold** are stock items and usually ship within 24 hours. Please use stock number when ordering.
 2. Minimum order quantity is one box unless otherwise noted.



Residential Hinges



Description	Finish	2021 List	Stock No.	Box Qty.	Case Qty.	Disc. Code	
RC1842 Steel 5/8" Radius Round Corner Full Mortise Residential Wt. Plain Bearing with screws U/M - 1 each	3-1/2" x 3-1/2" (89 mm x 89 mm)	USP	2.24	029759	2 each	100 each	81G
	1D	6.42	030857				81A
	2D	2.24	029756				81G
	US3	6.42	030851				81A
	3LB	2.24	029847				81G
	US4	2.24	029757				81G
	ABA/US5	6.42	030853				81A
	US10A	6.42	030843				81A
	10R	6.42	042009				81C
	US15	6.42	030856				81C
	AN/US15A	6.42	030859				81A
	US26	6.42	030845				81A
	US26D	6.42	030846				81A
	4" x 4" (102 mm x 102 mm)	USP	3.30	029774	2 each	50 each	91G
		1D	7.60	032899			91A
		2D	3.30	029769			91G
		US3	7.60	033312			91A
		3LB	3.30	029771			91G
		US4	3.30	029770			91G
ABA/US5		7.60	033313			91A	
US10A		7.60	033309			91A	
10R		7.60	042010			91C	
US15		7.60	032898			91C	
AN/US15A		7.60	033314			91A	
US26		7.60	033310			91A	
US26D		7.60	033311			91A	
RCBB1842 Steel 5/8" Radius Round Corner Full Mortise Residential Wt. Ball Bearing with screws U/M - 1 each		3-1/2" x 3-1/2" (89 mm x 89 mm)	1D	10.78	084215	2 each	100 each
	US3	10.78	034363				82A
	3LB	6.60	034375				82G
	US4	6.60	034374				82G
	ABA/US5	10.78	034367				82A
	US10A	10.78	034366				82A
	10R	10.78	042006				82A
	US15	10.78	034370				82A
	AN/US15A	10.78	034371				82A
	US26	10.78	034364				82A
	US26D	10.78	034365				82A
	4" x 4" (102 mm x 102 mm)	1D	11.90	084231	2 each	50 each	92A
		2D	7.66	034526			92G
		US3	11.90	034515			92A
		3LB	7.66	034528			92G
		US4	7.66	034527			92G
		ABA/US5	11.90	034520			92A
		US10A	11.90	034519			92A
		10R	11.90	042007			92A
US15		11.90	034523			92A	
AN/US15A		11.90	034524			92A	
US26		11.90	034516			92A	
US26D		11.90	034518			92A	





Description	Finish	2021 List	Stock No.	Box Qty.	Case Qty.	Disc. Code	
RC1843	4" x 4"	US3	9.47	033649	2 each	50 each	9DA
Steel	(102 mm x 102 mm)	3LB	4.24	081897			9DG
5/8" Radius		US4	4.24	081896			9DG
Round Corner		ABA/US5	9.47	036149			9DA
Full Mortise		10R	9.47	042014			9DA
Residential Wt.		US15	9.47	081894			9DA
Plain bearing with screws		AN/US15A	9.47	081898			9DA
Safety Stud		US26	9.47	081895			9DA
U/M - 1 each		US26D	9.47	037158			9DA



RC1843	4" x 4"	USP	4.30	033589	-	100 each	9EG
Steel	(102 mm x 102 mm)	2D	4.30	060571			9EG
5/8" Radius		US3	9.47	037028			9EA
Round Corner		ABA/US5	9.47	060565			9EA
Full Mortise		10R	9.47	129302			9EA
Residential Wt.		US15	9.47	060597			9EA
Bulk Assembled with screws		US26	9.47	060593			9EA
See style #2817		US26D	9.47	126537			9EA
Safety Stud							
U/M - Each - Bulk							



RC1846	4" x 4"	2D	4.80	033651	2 each	50 each	9AG
Steel	(102 mm x 102 mm)	US3	12.40	033844			9AA
5/8" Radius		US26D	12.40	033843			9AA
Round Corner							
Full Mortise							
Residential Wt.							
Plain Bearing with screws							
Riveted Pin							
U/M - 1 each							



RC1846	4" x 4"	USP	4.80	071618	-	100 each	9BG
Steel	(102 mm x 102 mm)	2D	4.80	071634			9BG
5/8" Radius		US3	8.85	072996			9BA
Round Corner		3LB	4.80	029579			9BG
Full Mortise		10R	8.85	040422			9BA
Residential Wt.		US15	8.85	073003			9BA
Plain Bearing		AN/US15A	8.85	072986			9BA
Bulk assembled with screws		US26	8.85	072999			9BA
See style #2817 for screws		US26D	8.85	072994			9BA
Riveted Pin		1D	8.85	073004			9BA
U/M - Each - Bulk							



RC1847	4" x 4"	USP	4.80	033658	2 each	50 each	9AG
Steel	(102 mm x 102 mm)	2D	4.80	033654			9AG
Square by 5/8" Radius		US3	12.40	037777			9AA
Full Mortise							
Residential Wt.							
Plain Bearing with screws							
Riveted Pin							
U/M - 1 each							

1. Items with prices in **bold** are stock items and usually ship within 24 hours. Please use stock number when ordering.
2. Minimum order quantity is one box unless otherwise noted.



Residential Hinges

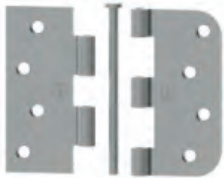

Description		Finish	2021 List	Stock No.	Box Qty.	Case Qty.	Disc. Code	
RC1847 Steel Square by 5/8" Radius Full Mortise Residential Wt. Bulk Assembled with screws See style #2817 for screws Fast Riveted Pin U/M - Each - Bulk	4" x 4" (102 mm x 102 mm)	USP	4.80	033590	-	100 each	9BG	
		2D	4.80	060544			9BG	
		US3	8.85	060545			9BA	
		10R	8.85	040423			9BA	
		US15	8.85	072125			9BA	
		US26D	8.85	060551			9BA	
	<hr/>							
	1848 Steel Unassembled Square by 5/8" Radius Full Mortise Residential Wt. Plain Bearing with screws U/M - 1 each	4" x 4" (102 mm x 102 mm)	US3	7.60	068746	2 each	50 each	91A
		ABA/US5	7.60	067438			91A	
		US10A	7.60	068789			91A	
		10R	7.60	042019			91C	
		US15	7.60	068735			91C	
		AN/US15A	7.60	068713			91A	
		US26D	7.60	068734			91A	
<hr/>								
2617 Screws for Residential Hinges U/M - Pack of 600	#9 x 3/4" FPHS	USP	44.10	035459	1 pack	10 packs	701	
		1D	36.40	034111				
		2D	36.40	034108				
		3LB	36.40	029794				
		US3	36.40	034109				
		US4	36.40	029793				
		ABA/US5	36.40	033323				
		US10A	36.40	033320				
		10R	36.40	042098				
		US15	36.40	033321				
		AN/US15A	36.40	033324				
	US26	36.40	033322					
	US26D	36.40	034110					





Description	Finish	2021 List	Stock No.	Box Qty.	Case Qty.	Disc. Code	
2817 Screws for Residential Hinges U/M - Pack of 800	#9 x 3/4" FPHS	USP	48.62	033385	1 pack	10 packs	701
		1D	48.62	034124			
		2D	48.62	034129			
		3LB	48.62	029796			
		US3	48.62	033384			
		US4	48.62	029795			
		ABA/US5	48.62	034126			
		US10A	48.62	034303			
		10R	48.62	042099			
		US15	48.62	034302			
		AN/US15A	48.62	034123			
		US26	48.62	033327			
		US26D	48.62	033329			
	<hr/>						
	#9 X 1" FPHS	USP	52.58	033386	1 pack	10 packs	701
1D		52.58	037331				
2D		52.58	035480				
3LB		52.58	029798				
US3		52.58	033387				
US4		52.58	029797				
ABA/US5		52.58	035550				
US10A		52.58	035461				
10R		52.58	042100				
US15		52.58	036448				
AN/US15A		52.58	035556				
US26		52.58	035582				
US26D		52.58	033388				
<hr/>							
#9 x 2-1/2" FPHS		USP	69.47	048598	1 pack	-	701
#10 x 2-1/2" FPHS	2D	69.47	048601	1 pack	-	701	
<hr/>							
7741 Steel 1/4" Radius Round Corner Full Mortise Residential Wt. Plain Bearing See style #2617 & #2817 for screws	3-1/2" x 3-1/2" (89 mm x 89 mm)	2D	2.06	029502	-	100 each	83G
		3LB	2.06	071615			83G
		US4	2.06	045632			83G
		10R	5.92	072122			83C
		US15	5.92	072118			83C
		AN/US15A	5.92	050817			83A
		US26	5.92	060536			83A
		US26D	5.92	060531			83A
	<hr/>						
	Bulk Unassembled with pins U/M - Each - Bulk	4" x 4" (102 x 102 mm)	2D	2.93	060520	-	100 each
		3LB	2.93	060521			93G
		US4	2.93	060513			93G
		10R	6.98	060516			93C
		US15	6.98	060517			93C
		AN/US15A	6.98	051297			93A
		US26	6.98	060518			93A



1. Items with prices in **bold** are stock items and usually ship within 24 hours. Please use stock number when ordering.
2. Minimum order quantity is one box unless otherwise noted.



Residential Hinges



Description	Finish	2021 List	Stock No.	Box Qty.	Case Qty.	Disc. Code
8741		3-1/2" x 3-1/2"	2D	2.99	061574	- 100 each 83G
Steel		(89 mm x 89 mm)	3LB	2.06	029497	83G
5/8" Radius			10R	5.92	061592	83A
Round Corner			US15	5.92	061572	83C
Full Mortise						
Residential Wt.		4" x 4"	10R	6.98	040623	93C
Plain Bearing		(102 mm x 102 mm)	US15	6.98	061556	93C
Bulk Unassembled with pins						
See style #2617 & #2817 for screws						
U/M - Each - Bulk						

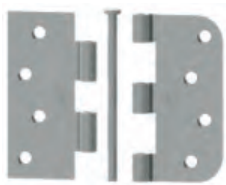

8744		4" x 4"	USP	2.99	071599	- 100 each 93G
Steel		(102 mm x 102 mm)	1D	6.98	072097	
Square by 5/8" Radius			2D	2.99	071610	93G
Full Mortise			3LB	2.99	071611	93G
Residential Wt.			US4	6.98	071607	93G
Plain Bearing			10R	6.98	072113	93C
Bulk Unassembled with pins			US15	6.98	072109	93C
See style #2817 for screws			US26D	6.98	072090	93A
U/M - Each - Bulk						



8746			1D	9.47	060492	- 100 each 9EA
Steel		4" x 4"	2D	4.30	060487	9EG
Square by 5/8" Radius		(102 mm x 102 mm)	US4	4.30	060479	9EG
Full Mortise			ABA/US5	9.47	060475	9EA
Residential Wt.			US15	9.47	060502	9EA
Plain Bearing			10R	9.47	040415	9EA
Safety Stud						
Bulk Unassembled with pins						
See style #2817 for screws						
U/M - Each - Bulk						



1700		3-1/2" (89 mm)	2D	0.81	038152	100 each 1000 each 900
Pins for Residential Wt.			US15	0.81	038173	
Plain Bearing Hinges			US26D	0.81	038174	
Sold full box qty		4" (102 mm)	2D	0.81	038153	100 each 1000 each 900
U/M - 1 Each			US15	0.81	038166	





Description		Finish	2021 List	Stock No.	Box Qty.	Case Qty.	Disc. Code
1710	3-1/2" (89 mm)	US3	13.46	042118	10 packs	100 packs	780
Hinge Tip Kit		US4	13.46	058503			
2 Ball Tips in Solid Brass with 1		ABA/US5	13.46	058500			
Stainless Steel Pin for One		US10A	13.46	058506			
Residential Wgt.		10R	13.46	097381			
HingeU/M - Pack of 1 each		US15	13.46	037713			
		AN/US15A	13.46	037940			
		US26	13.46	058559			
		US26D	13.46	058502			
	4" (102 mm)	US3	13.46	042129	10 packs	100 packs	780
		US10A	13.46	058973			
		10R	13.46	097383			
		US15	13.46	037848			
		US26	13.46	058974			



1720	3-1/2" (89 mm)	US3	13.46	042134	10 packs	100 packs	780
Hinge Tip Kit		ABA/US5	13.46	058579			
2 Steeple Tips in Solid Brass		10R	13.46	097693			
with 1 Stainless Steel Pin for		US26	13.46	058575			
One Residential Wgt. Hinge	4" (102 mm)	10R	13.46	097385	10 packs	100 packs	780
U/M - Pack of 1 each		US15	13.46	038419			
		US26	13.46	058989			

1. Items with prices in **bold** are stock items and usually ship within 24 hours. Please use stock number when ordering.
2. Minimum order quantity is one box unless otherwise noted.



eConestoga Barn Door Hardware Series



Description	Finish	2021 List	Stock No.
9456-72 Flat Rail Steel Black Top Mount 72" Track Kit Includes Track	BLK	218.90	96467



9456-96 Flat Rail Steel Black Top Mount 96" Track Kit Includes Track	BLK	244.65	96466
---	-----	--------	-------



9457-72 Flat Rail Steel Black 3" Hook 72" Track Kit Includes Track	BLK	244.65	96427
---	-----	--------	-------



9457-96 Flat Rail Steel Black 3" Hook 96" Track Kit Includes Track	BLK	270.40	96388
---	-----	--------	-------



1-269-8649 Flat Rail Track Connector	BLK	12.90	96361
--	-----	-------	-------



1-269-8648 72" Rail Only	BLK	90.15	96355
------------------------------------	-----	-------	-------



1-269-8647 96" Rail Only	BLK	103.00	96353
------------------------------------	-----	--------	-------



1-269-8646 Flat Rail Soft Close Add On	BLK	64.40	96352
--	-----	-------	-------



How to Order

9458

Product Group

2D

Backset / Faceplate

2D (2-1/4")

35 (3-1/2")

BLK

Finish

BLK (Black)

US32D

US10B

For 1-3/8" (35mm) to 1-3/4"(40mm) thick doors standard.

- Non-handed.
- ADA Compliant thumb turn for commercial applications
- 2-1/4" or 3-1/2" backset options (see specifications for corresponding wall thickness).
- Drive in bolt casing diameter: 1" (25mm).
- Lock bolt: 1/2" (13mm) diameter, stainless Steel material.
- Lock bolt has 1" projection allowing up to 1/2" door to wall gap. Extra spacer ring accommodates up to 3/4" gap between barn door and wall.
- 1-1/4" diameter spring-loaded dust proof strike provides ample space to receive 1/2" bolt, allows easy locking from privacy side. Strike mounted in barn door for standard door.



Description	Finish	2021 List	Stock No.
94582D-32D Round ADA TT Stainless 2-1/4" Backset	32D	182.10	86683
94582D-10B Round ADA TT Oil Rubbed Bronze 2-1/4" Backset	10B	182.10	86672
94582D-BLK Round ADA TT Black 2-1/4" Backset	BLK	182.10	86664
945835-32D Round ADA TT Stainless Steel 3-1/2" Backset	32D	182.10	86663
945835-10B Round ADA TT Oil Rubbed Bronze 3-1/2" Backset	10B	182.10	86657
945835-BLK Round ADA TT Black 3-1/2" Backset	BLK	182.10	86653

1. Items with prices in **bold** are stock items and usually ship within 24 hours. Please use stock number when ordering.
2. Minimum order quantity is one box unless otherwise noted.



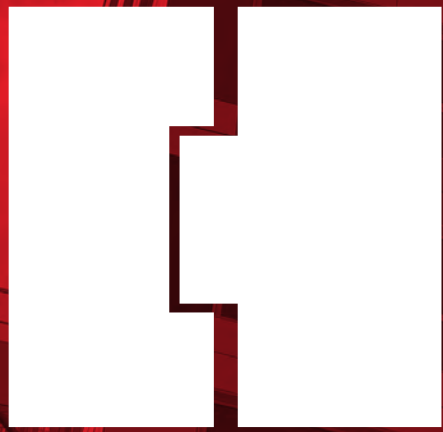

HAGER®

COMPANIES

TABLE OF CONTENTS

	A			M
ANSI Standards.....		2	Mortar Box.....	11
	B			P
Bearing at Top		12	Painted Cover Channels.....	6
Bearing Replacement Kit.....		14	Polished Cover Channels.....	6
	C			Q
Cancellation Notification		2	Quick Connect.....	9
Center Punches		14	Quick Ship.....	2
Concealed Electric Hinges with Lead Wire.....		7-10		R
Concealed Electric Monitoring (EMN).....		7-10	Replacement Moldings	11
Concealed Electric Through-Wire (ETW).....		7-10		S
Concealed Electric Through-Wire - Removable (RETW)		7-10	Shim Stock.....	15
Concealed Electric Through-Wire and Monitoring (ETM)		7-10	Shipping Cartons	15
Custom Hole Pattern		12	Short Hinges.....	12
	D		Special Anodizing	6
Dutch Door Prep		14	Special Cover Channels	5
	E		Special Finished Hinges.....	6
Electric Power Transfer Preparation (EPT).....		9	Special Holes	6
Electrical Modifications		7-10	Special Lengths	3
Exposed Electric Contacts (E).....		7-10	Special Products.....	3
Exposed Electric Switches (EIS).....		7-10	Standard Finishes.....	3
Extra Long Hinges.....		12	Standard Lengths.....	3
Power Transfer Preparation.....		9		T
	F		Tamper Resistant Hinge.....	14
Fasteners.....		15	Template Hinges.....	3
Field Modifications.....		3	TIPIT®	13
Fire Ratings		4		
	H			
Hinges				
Concealed.....		16, 17, 19-23, 24, 26-27, 29		
Full Surface.....		16, 19, 23-25, 28		
Half Surface		16-19, 23, 25, 28		
Hospital Tip.....		13		
How To Order		2		
	L			
Lead Times		2		
Length Specifications.....		3		



Roton Continuous Hinges

HOW TO ORDER:

Example: 780-112HDFFUL 119" CLR 1 PK

Stock Number: 184038

Item Number: YS 1121190CLR000001 Rev. S



INTRODUCTION

Hager Roton hinges are unique, aluminum geared hinges developed to outperform most other entrance components because the weight of the door is distributed along the full length of the door frame.

Roton continuous hinges have been utilized in hospitals, schools, hotels, offices, airports, stadiums, storefronts, and commercial and industrial buildings in new construction and retrofit applications for over 30 years.

Hager Roton continuous geared hinges are designed for superior performance. Because of this, we offer our lifetime warranty with confidence.

ANSI Standards

- 780 Series Roton continuous geared hinges are approved per ANSI A156.26 Grade 1 for 150 lb. doors
- 780 Series Roton heavy duty hinges are approved per ANSI A156.26 Grade 1 for 300 lb. doors
- 780-111, 780-112, 780-124HD, 780-224, 780-226 standard duty and heavy duty Roton continuous geared hinges are Warnock-Hersey certified in accordance with ANSI A250.13 2003 Standard Severe Windstorm Resistant Components.



Lead Times

Stock items will typically ship in five working days or less from the order entry date. Made-to-order items will typically ship in 15 working days depending on seasonal volume and order complexity. Special orders including industrials, special machining, and large quantities may need to be scheduled. The anticipated ship date will be included with each order acknowledgement. Please contact Customer Service if product availability is in question.

Quick Ship

Products denoted with **red and bold** pricing are available to order through the Quick Ship program and ship within 24 hours. When ordering these products please visit www.hagerco.com and log in to MyHager to access the 'Quick Ship' portal. Due to the promptness of the fulfillment process, Quick Ship orders are non-cancellable.

Cancellation Notification

Cancellation for made to order items must be completed within 48 hours of order placement.

Standard Lengths

Roton hinges are listed and priced as actual lengths 79" (6'8" opening), 83" (7'0" opening), 85" (7'2" opening), 95" (8'0" opening), and 119" (10'0" opening) for convenience in application to nominal sized doors. Actual length provides for threshold clearance, head clearance and door height allowances for carpeting. Other lengths may be ordered as non-standard items.

Special Lengths

Should a non-standard length be required, please price as the next standard length. (For example, if 86" length is required, use 95" list price.)

Length Specifications

If special lengths to match the actual net door heights are required, please indicate this clearly on your order. A special length should be specified from the net door height, not the nominal height of the opening. To order specify: "Actual Length", or "Net Door Height". Use pricing for the next longer standard length from which the special length can be manufactured. For example, hinges 86-3/4" long will be invoiced at the 95" price.

Field Modifications

While Roton hinges can be cut in the field, any product modifications may void all warranties. Should in-the-field modifications be required, cut only from bottom of hinge. Do not cut through bearings or screw holes. When cutting electric hinges it is extremely important to clamp both hinge leaves securely to prevent hinge "chatter" which can damage the hinge's internal wiring. Consult the St. Louis sales office before proceeding.

Template Hinges

Hager has developed templated hole patterns for Roton hinge models in standard lengths. Drawings are available upon request by contacting Hager Customer Service or accessing the Hager website at www.hagerco.com.

Due to normal variances inherent in the manufacturing process, Roton custom length hinges are deemed by Hager to be non-templated.

Standard Finishes

Roton hinges are available in clear anodized satin aluminum (similar to US28), dark bronze and black exterior anodized coating.

Special Products

A special product is any product not listed in the price book in regard to length, finish, standard hole preparation or leaf combinations not illustrated. Orders for special products are encouraged, but any changes or cancellations on special orders may result in charges related to work performed and/or material loss. Under no circumstance will non-stock or make-to-order products be accepted for return unless due to Hager error.



Roton Continuous Hinges

FIRE RATINGS - UNDERWRITERS LABORATORY FIRE RATING FILE #A14627



780 Series Roton continuous geared hinges with stainless steel studs are approved for use on 4'x10' metal or wood swing type doors. 780 Series Roton continuous geared hinges without stainless steel studs are approved for use on 4'x8' single swing metal doors and 4'x10' single swing wood doors used without stainless steel studs limited to 20 minute fire rating without hose stream.

- Hollow metal, tin-clad, sheet-metal and steel covered composite type rated up to and including 3 hours
- Wood composite doors rated up to and including 1-1/2 hours
- Wood core doors rated up to 20 minutes without hose stream, non-studded
- 780 Series Roton Continuous Geared Hinges meet requirements for positive pressure UL10C, UL10B and UBC7-2 Part 1

UL10C Fire Rated Roton	Fully Concealed	Full Surface	Half Surface	NOTES: 1. All Roton hinges will be marked with UL stamp if they are fire-rated. 2. Several hinge models cannot be fire-rated. Check each profile. 3. Models that require studs have an extra charge. Four studs are required for UL stud hinges. Add to the hinge list price before applying buying group discount - add \$56.80 .
20 Minute Fire Rated Wood Core Door x Fire Rated Hollow Metal Frame	UL — FF STANDARD			
20 Minute Fire Rated Metal Door x Fire Rated Hollow Metal Frame	UL — FF STANDARD			
30 Minute Fire Rated Wood Composite Door x Fire Rated Hollow Metal Frame	UL — FF STANDARD			
30 Minute Fire Rated Metal Door x Fire Rated Hollow Metal Frame	UL — FF STANDARD			
45 Minute Fire Rated Wood Composite Door x Fire Rated Hollow Metal Frame	UL — FF STANDARD			
45 Minute Fire Rated Metal Door x Fire Rated Hollow Metal Frame	UL — FF STANDARD			
60 Minute Fire Rated Wood Door x Hollow Metal Frame	UL — FF STANDARD			
60 Minute Fire Rated Metal Door x Hollow Metal Frame	UL — FF STANDARD			
90 Minute Fire Rated Metal Door x Fire Rated Hollow Metal Frame	UL — FF STANDARD			
90 Minute Fire Rated Wood Composite Door x Fire Rated Hollow Metal Frame	UL — STUD REQUIRED * Must Specify			
3 Hour Fire Rated Metal Door x Fire Rated Hollow Metal Frame	UL — STUD REQUIRED * Must Specify			

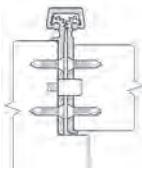

FULLY CONCEALED WITH STUD

Fully Concealed

These models are concealed between the frame and the hinge edge of the door. Models available include: 780-041HD, 780-041LL, 780-111, 780-111HD, 780-111LL, 780-112, 780-112HD, 780-112LL, 780--124HD, 780-124LL, 780-224, 780-224HD, 780-224LL, 780-226, 780-226HD, 780-226LL, and 780-235HD.

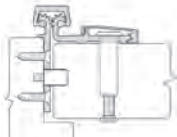

HALF SURFACE WITH STUD

Half Surface

These models have the frame leaf concealed between the frame and the edge of the door. The door leaf is mounted to the door with thru-bolts or screws. Models available include: 780-045HD, 780-046HD, 780-053, 780-053HD, 780-054HD, and 780-211HD.

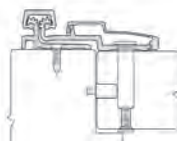

FULL SURFACE WITH STUD

Full Surface

These models have the frame leaf mounted to the face of the frame and the face of the door. The door leaf is mounted to the face of the door with thru-bolts. Models available include: 780-057HD, 780-157, 780-157HD, 780-210, 780-210HD, and 780-257HD.



MODIFICATIONS & ADDITIONS

Special Cover Channels

Rounded back cover channels may be ordered. Availability for hinges with electrical modifications vary.

Please consult the St. Louis sales office for confirmation. Add to the hinge list price before applying buying group discount:

Round Back Cover Channels

Clear Anodized

79", 83", 85"	\$26.70
95"	\$33.10
119"	\$42.60

Bronze Anodized

79", 83", 85"	\$53.25
95"	\$59.60
119"	\$68.15

Black Anodized

79", 83", 85"	\$61.25
95"	\$68.60
119"	\$78.40

Note: Special cover channels available in clear, dark bronze and black finish.

Roton Cover Channel Compatibility		
Hinge Model	Flat FBCC	Round RBCC
750-134	•	
750-138	•	
780-041	•	•
780-045	•	•
780-046	•	•
780-053	•	•
780-054	•	•
780-057	•	•
780-110	•	•
780-111	•	•
780-112	•	•
780-113	•	•
780-124	•	•
780-155	•	•
780-157	•	
780-210	•	•
780-211	•	•
780-213	•	•
780-224	•	•
780-226	•	•
780-235	•	•
780-259	•	•
780-300	•	

* Round back (RBCC) is not compatible with molded Hospital Tip option.



Roton Continuous Hinges

MODIFICATIONS & ADDITIONS PRICE

ADDITION TO LIST

Bone White Painted Cover Channels

For hinges 79", 83" and 85" in length

\$63.95

For hinges 95" in length

\$87.30

For hinges 119" in length

\$129.80

Roton cover channels are offered in bone white as a standard stock color option. This is only available on the standard Roton cover channel and should be ordered as bone white paint # UC43350.

Polished Cover Channels

CLEAR

GOLD

For hinges 79" in length

\$63.95

\$87.30

For hinges 83" in length

\$63.95

\$87.30

For hinges 85" in length

\$63.95

\$87.30

For hinges 95" in length

\$87.30

\$108.50

For hinges 119" in length

\$128.70

\$148.90

Any hinge may be ordered with a polished clear cover channel (similar to US26) to complement clear anodized hinge leaves or a polished gold cover channel (similar to US3) to complement satin gold hinge leaves.

Special Finished Hinges

Price on Application

Hager Companies can supply unfinished material to selected finishers for special projects that require unusual colors, but will require that final assembly be complete by Hager Companies. Because of special non-removable metal coatings applied to all hinges during assembly, users are cautioned against attempting to refinish any Roton product. Lead time of up to 10-12 weeks may be required.

Cannot paint 500 or 1200 series hinges.

Special Anodizing

Add 20% to the DBA hinges for gold

Roton hinges are available in various special colors including Black, Gold, and other special anodized finishes with fasteners to match. Example, specify "Black Anodized" or "Gold Anodized." All hinges ordered in special colors should be ordered at the same time to guarantee finish uniformity.

Other anodized colors by quotation only. Supply color chip for best match.

Special Holes

Price on Application

Any hinge may be ordered with special hole locations for unusual frame or door locations. Please provide specification for each leaf.



ROTON ELECTRICAL MODIFICATIONS

- A = Opening
- B = Door height
- C = Actual hinge length
- D = C.L. of EMN (electric monitor)
- E = C.L. of ETM (electric through-wires & monitor)
- F = C.L. of ETW (electric through-wires)
- G = C.L. of EPT (electric power transfer)
- H = C.L. of E1S (exposed switch)
- J = C.L. of E (exposed contact)
- K = C.L. of RETW (removable electric through-wires)

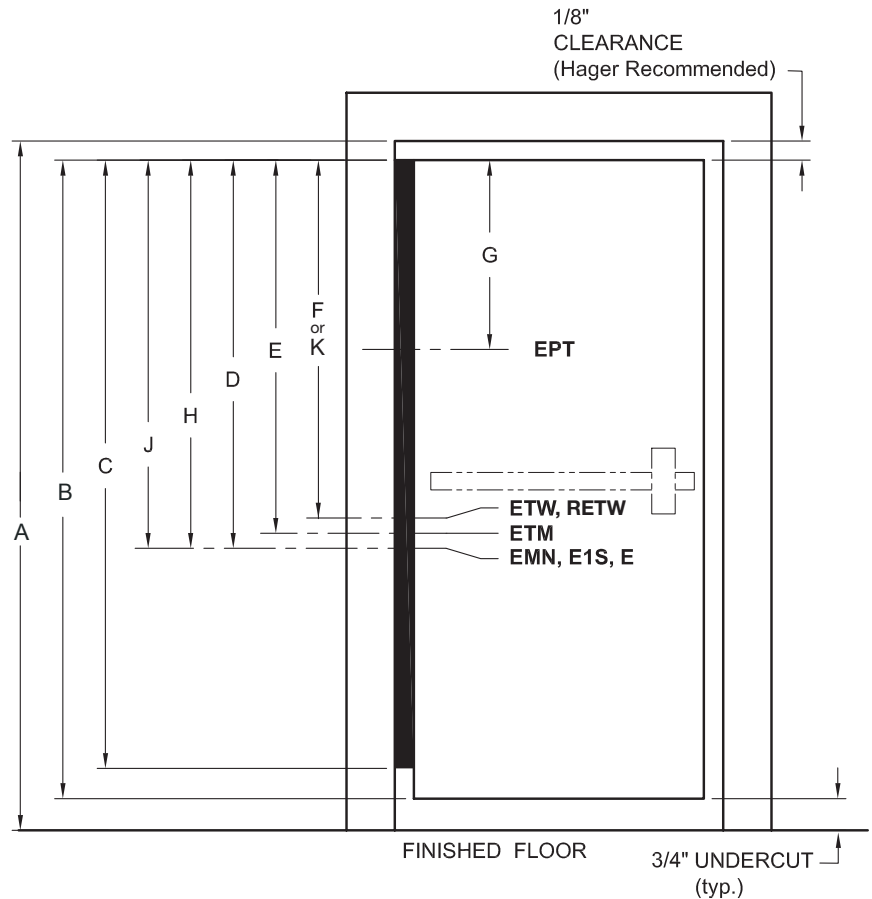

For ease of ordering, Hager Companies has established standard locations for power transfer cutouts. All standard location dimensions are referenced from the top edge of the door to the centerline of the power transfer cutout. Please specify handing.

NOTE: These locations are for concealed hinges only.

	Opening	Door Height	Actual Hinge Length	EMN	ETM	ETW	EPT	E1S	E	RETW
79 SD	80"	79-1/8"	79"	40-3/4"	42-3/4"	40-3/4"	34-3/8"	42-1/2"	42-1/2"	-
79 HD	80"	79-1/8"	79"	40-3/4"	43-3/8"	40-3/4"	34-3/8"	42-1/2"	42-1/2"	43-3/8"
83 SD	84"	83-1/8"	83"	45-5/16"	44-3/4"	45-5/16"	36-3/8"	46-1/2"	46-1/2"	-
83 HD	84"	83-1/8"	83"	45-5/16"	45-3/8"	45-5/16"	36-3/8"	46-1/2"	46-1/2"	45-3/8"
85 SD	86"	85-1/8"	N/A	N/A	N/A	N/A	N/A	N/A	N/A	N/A
85 HD	86"	85-1/8"	85"	46-5/16"	46-3/8"	46-5/16"	37-3/8"	48-1/2"	48-1/2"	46-3/8"
95 SD	96"	95-1/8"	95"	56-3/8"	55-13/16"	56-3/8"	47-1/2"	59-3/4"	59-3/4"	-
95 HD	96"	95-1/8"	95"	56-3/8"	56-1/2"	56-3/8"	47-1/2"	59-3/4"	59-3/4"	56-1/2"
119 SD	120"	119-1/8"	N/A	N/A	N/A	N/A	N/A	N/A	N/A	N/A
119 HD	120"	119-1/8"	119"	81-1/4"	81-5/16"	81-1/4"	72-5/16"	83-3/4"	83-3/4"	81-5/16"

SD = Standard Duty

HD = Heavy Duty



Roton Continuous Hinges

ROTON ELECTRICAL MODIFICATIONS (CONTINUED)

	Von Duprin EPT 2 or EPT 10 Power Transfer Preparation	Exposed Electric Contacts	Exposed Electric Switches	Concealed Electric Through-Wire	Concealed Electric Monitoring	Concealed Electric Through-Wire and Monitoring	Removable Electric Through-Wire
Part Number	EPT	E	E1S	ETW	EMN	ETM	RETW
780-045HD	•						
780-046HD	•						
780-053	•						
780-053HD	•						
780-054HD	•						
780-110HD			•				
780-057				•			•
780-111	•	•	•	•	•	•	
780-111HD	•	•	•	•	•	•	•
780-111LL	•	•	•	•	•	•	
780-112	•	•	•	•	•	•	
780-112HD	•	•	•	•	•	•	•
780-112LL	•	•	•	•	•	•	
780-124HD	•	•	•	•	•	•	•
780-124LL	•	•	•	•	•	•	
780-157				•			•
780-224	•	•	•	•	•	•	
780-224HD	•	•	•	•	•	•	•
780-224LL	•	•	•	•	•	•	
780-226HD	•	•	•	•	•	•	•
780-226LL	•	•	•	•	•	•	
1200-600	•			•			
1200-650	•			•			



**MODIFICATIONS & ADDITIONS
PRICE**

ADDITION TO LIST

Quick Connect

\$47.90

Available for ETM, ETW, and RETW options. Top and bottom knockouts for standard conduit fittings.

Concealed Electric Monitoring (EMN)

\$268.40

- Miniature switch is incorporated into the frame leaf.
- Specify handing and the dimension from the top edge of the door to the centerline of the electric monitoring location.
- Special Electric Modifications and EPT locations may require additional charges if screw holes have to be moved.
- Templates regarding location of monitoring switch available upon request.

Concealed Electric Through-Wire and Monitoring (ETM)

- Electric Preparation

ETM-4

\$535.70

ETM-8

\$621.80

ETM-10

\$662.25

- All ETM have 28-Gauge continuous conductors.
- This combines the continuous electric conductors and the miniature switch to provide both power transfer and monitoring.
- Miniature switch is incorporated into the frame leaf.
- Specify handing and the dimension from the top edge of the door to the centerline of each electric modification location.
- Templates regarding location of monitoring switch available upon request.

Concealed Electric Through-Wire (ETW)

- Electric Preparation

ETW-4

\$268.40

ETW-8

\$349.40

ETW-10

\$398.00

ETW-12

\$445.40

- All ETW have 28-Gauge continuous conductors.
- 12" per side required as a suffix.
- Cut out for prep - 1/2" drilled hole.
- Transfers power discreetly from building to door hardware.
- Specify handing and the dimension from the top edge of the door to the centerline of the electric through-wire location.
- Special electric modifications and EPT locations may require additional charges if screw holes have to be moved. Contact Hager Customer Service for charges.
- Templates regarding location of through-wires available upon request.

Available on the following Roton profiles:

- 780-057HD • 780-112HD • 780-157HD • 780-226HD • 1200-650HD
- 780-111HD • 780-124HD • 780-224HD • 1200-600HD

Power Transfer or Electric Power Transfer Preparation (EPT)

Concealed Leaf

\$104.40

Half Surface

\$62.90

- Hinge leaf cutout to accommodate power transfer device.
- Specify handing and the dimension from the top edge of the door to the **centerline** of the power transfer location.
- Special Electric Modifications and EPT locations may require additional charges if screw holes have to be moved.



Roton Continuous Hinges

MODIFICATIONS & ADDITIONS PRICE

ADDITION TO LIST

Lead Wire for Concealed Electric Hinges

Electric Preparation

4-wire hinge

8-wire hinge

10-wire hinge

- Standard wire leads are 12" per side
- Additional wire leads are available

Per Foot

\$9.25

\$16.80

\$19.05

Exposed Electric Switches (E1S)

\$93.80

- Miniature push button switch incorporated in hinge frame leaf to monitor position of the door.
- Three 12" wire leads.
- Each monitoring hinge only needs one E1S Switch.
- Specify handing and the dimension from the top edge of the door to the centerline of the electric switch location.
- Templates regarding location of contact switch available upon request.

Exposed Electric Contacts (E)

\$93.80

- Transfers power to door in closed position.
- Must have at least two (2) contacts to transfer power.
- Specify handing and the dimension from the top edge of the door to the centerline of the electric contact location.
- Templates regarding location of contacts available upon request.

Removable Electric Through-Wire (RETW) Twelve Wire

\$651.45

Removable 12 Wire Module Only

\$265.65

Component

7-102-1870

7-112-1872

7-112-1876

7-112-1881

Finish

Clear

Dark Bronze

Gold

Black

Removable Electric Through-Wire (RETW) Ten Wire

\$552.10

Removable 10 Wire Module Only

\$214.90

Component

7-102-1860

7-112-1870

7-112-1875

7-112-1880

Finish

Clear

Dark Bronze

Gold

Black



Available on heavy duty profiles:

- 780-057HD
- 780-112HD
- 780-157HD
- 780-226HD
- 780-111HD
- 780-124HD
- 780-224HD

- Transfers power discreetly from building to door hardware.
- Removable ETW module can be easily removed for adjustment for service.
- Templates regarding location of monitoring switch available upon request.
- Specify handing and the dimension from the top edge of the door to the centerline of the electric through-wire location.

MODIFICATIONS & ADDITIONS

Mortar Box - 430

\$47.90

- Serves as a mortar shield.
- Overall dimensions: 9" (229 mm) length with tabs, 7" (178 mm) inside, 1-3/4" x 1-3/4" (45 mm x 45 mm) inside dimension.
- Galvanized steel 0.040" (1 mm)

**Replacement Molding
780-052M**

Hinge Lengths

79", 83", 85"
95"
119"

Clear Anodized

\$38.60
\$44.60
\$53.25

Dark Bronze Anodized

\$44.60
\$53.25
\$61.80

Replacement door leaf molding for: 780-053, 780-053HD, 780-054HD, 780-155HD, 780-057HD, 780-157, 780-157HD, 780-257HD, and 780-259HD.

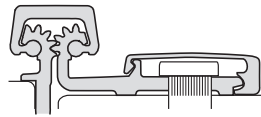

**Replacement Molding
780-210M**

Hinge Lengths

79", 83", 85"
95"
119"

Clear Anodized

\$40.60
\$50.20
\$58.80

Dark Bronze Anodized

\$50.20
\$58.80
\$66.45

Replacement door leaf molding for: 780-210, 780-210HD, 780-211, 780-211HD, 780-213HD, 780-045HD, and 780-046HD.

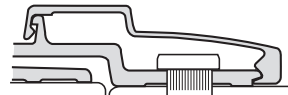

**Replacement Molding
780-247M**

Hinge Lengths

79", 83", 85"
95"
119"

Clear Anodized

\$34.50
\$40.60
\$50.20

Dark Bronze Anodized

\$40.60
\$50.20
\$58.80

Replacement frame leaf molding
780-157, 780-157HD, 780-257HD

Note: Replacement moldings for 780-052M and 780-210M are shipped in stock lengths for trimming in the field and furnished with Allen head set screw and wrench.

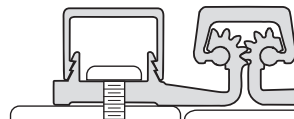

Roton Continuous Hinges

MODIFICATIONS & ADDITIONS PRICE

ADDITION TO LIST

Short Hinges

\$22.30

Hinges shorter than 79" will be invoiced at the 79" price. Where two or more short hinges can be obtained from a standard length, pricing is based on the number of standard lengths utilized plus an assembly charge for each hinge.

Extra Long Hinges

\$97.50

Hinges over 119" are manufactured as two separate lengths with a staggered joint for on-site connection. Hinge segments are taken from standard sizes for best economics in relation to the quantity required. Hanging specifications are required to position the cuts inconspicuously and to finish symmetrical pairs in double door applications.

Custom Hole Pattern

Price on Application

Any hinge may be ordered with special hole locations for unusual frame or door conditions. Please provide specifications for each leaf.

Bearing At Top

\$41.50

This application allows for the bearing to be set at the very top of the cover channel. The cover channel is flush with the top of the geared hinge, preventing any obstructions or debris from being inserted in the top of the channel.

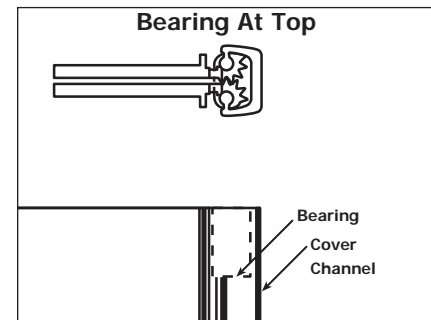

780 Series Concealed Molded Hospital Tip

\$122.50

780 Series Concealed and several Full Surface models can be prepared with a smooth tapered top bearing. This option is ideal for use in hospitals and correctional facilities to help provide a clean and safe environment. For Roton® Ligature-Resistant Opening Solutions see our TIPIT® section below. Not compatible with the round back cover channel option. For complete list of compatible models for this option, please reference chart on page 13.



Hospital Tip and TIPIT® Compatibility		
Part #	Molded Hospital Tip	TIPIT®
750-134		•
750-138		•
780-045		•
780-046		•
780-053		•
780-054		•
780-057	•	
780-110	•	•
780-111	•	•
780-112	•	•
780-113	•	•
780-124	•	•
780-155		•
780-157	•	•
780-210	•	•
780-211		•
780-224	•	•
780-226	•	•



Roton Continuous Hinges

MODIFICATIONS & ADDITIONS

TIPIT®

Designed to work with in new and retrofit applications, the TIPIT® was designed with safety in mind. When openings are fitted with the patented TIPIT® in conjunction with our Roton® Continuous Geared Hinge, this combination provides a safe environment while meeting institutional requirements for preventing objects from being hung from the top of the hinge.

Concealed

\$58.00



Full Surface (Gray or Black)

\$147.00



Tamper Resistant Hinge

\$143.80

This application is intended for use in hospital psychiatric areas and places of high security. The hinge is **prepared with a hospital tip** and every other bearing is supplied with a set screw to lock against the inside of the cover channel for additional security. 780 Series Concealed and Full Surface models (780-057, 780-157, and 780-210) are available in this configuration. Torx screws available at additional charge (see page 15).

Dutch Door Prep

\$85.15

Furnished as continuous frame leaf, whole door leaf is cut to fit dutch door specified length.

Bearing Replacement Kit

Standard Duty for 780 Series

Heavy Duty for 780 Series

Extra Heavy Duty for 1200 Series

Clear and Dark Bronze

\$43.65

\$83.10

\$165.15

Center Punches

Self-Centering center punches are available for #12 countersunk screws supplied. To make sure screw heads seat properly, accurate center punching is required.

\$9.75

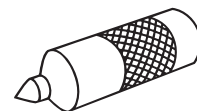

**MODIFICATIONS & ADDITIONS
PRICE**

ADDITION TO LIST

Shim Stock

1/16" x 1-1/2" Wide x 7' Long

1/8" x 1-1/2" Wide x 7' Long

\$33.60 each

\$46.85 each

Larger sizes available

Price on application

For clearance between the door and frame which may be excessive, a continuous shim is helpful (applied behind the frame leaf only). Anodized aluminum extrusions are supplied with no holes.

Shipping Carton

\$23.45 each

Extra shipping cartons are available for reshipping hinges in quantities of 2 or less.

Fasteners

All hinges are shipped with appropriate fasteners for metal doors and frames except where noted. **If wood screws are required, please specify on order, and wood screws will be substituted at no extra charge.** Bulk screws are packed separately.

Description	Part Numbers		
	Clear	Dark Bronze	
#12 x 1-1/2" Flat Head Wood Screw	7-080-0050	7-080-0051	\$259.70/box of 500
#12-24 x 11/16" Self-Drilling Flat Head Screw	7-080-0070	7-080-0072	\$232.20/box of 500
#12-24 x 1/2" Spanner Head Machine Screw			\$2.10 each
#12-24 x 11/16" Drill Quick Torx Screw			\$2.10 each
#12-24 x 13/32" Self-Threading Screw (Clear or Bronze)			\$0.85 each
#12-24 x 11/16" Self-Drilling Flat Head Screw (Clear or Bronze)			\$1.20 each
#12-24 x 11/16" Self-Drilling Pan Head Screw (Clear)			\$1.20 each
#12 x 1-1/2" Flat Head Wood Screw (Clear or Bronze)			\$1.20 each
Sexbolts			\$3.10 each

Note: Additional fasteners may be ordered as follows (add to the hinge list price before applying buying group discount).



Roton Continuous Geared Hinges

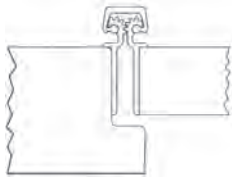

Description		Finish	2021 List	Stock No.	Case Qty.
500-048 Concealed Leaf With Sheet Metal Screws 1-1/6" Nominal Leaf Thickness	24" (610 mm)	Clear	73.85	068560	1
		Dark Bronze	98.40	068046	
	36" (914 mm)	Clear	83.65	068521	1
		Dark Bronze	110.75	-	
	48" (1219 mm)	Clear	98.40	068520	1
		Dark Bronze	123.00	067970	
72" (1829 mm)	Clear	123.00	068509	1	
	Dark Bronze	147.60	067969		

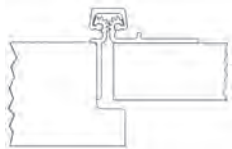

500-200 Half Surface With Sheet Metal Screws 1-1/6" Nominal Leaf Thickness	24" (610 mm)	Clear	73.85	067967	1
		Dark Bronze	98.40	067559	
	36" (914 mm)	Clear	86.15	067964	1
		Dark Bronze	110.75	067431	
	48" (1219 mm)	Clear	98.40	067961	1
		Dark Bronze	123.00	-	
72" (1829 mm)	Clear	123.00	067959	1	
	Dark Bronze	147.60	067266		

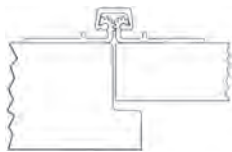

500-220 Full Surface With Sheet Metal Screws 1-1/6" Nominal Leaf Thickness	24" (610 mm)	Clear	73.85	067944	1
		Dark Bronze	98.40	-	
	36" (914 mm)	Clear	86.15	067940	1
		Dark Bronze	110.75	067009	
	48" (1219 mm)	Clear	98.40	067939	1
		Dark Bronze	123.00	067001	
72" (1829 mm)	Clear	123.00	067938	1	
	Dark Bronze	147.60	067000		

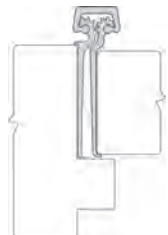

750-134 Concealed Leaf With Half Drill Quick and Half Wood Screws 1-3/4" Interior Wood Door	79" (2007 mm)	Clear	159.15	194853	8
	83" (2108 mm)	Clear	159.15	194855	8
	85" (2159 mm)	Clear	159.15	194859	8
	95" (2413 mm)	Clear	202.40	194861	8
	119" (3023 mm)	Clear	313.25	194863	6

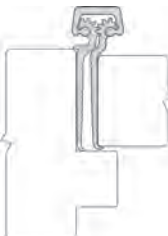

750-138 Concealed Leaf With Half Drill Quick and Half Wood Screws 1-3/8" Interior Wood Door	79" (2007 mm)	Clear	161.95	194890	8
	83" (2108 mm)	Clear	161.95	194897	8
	85" (2159 mm)	Clear	161.95	194909	8
	95" (2413 mm)	Clear	198.10	-	8
	119" (3023 mm)	Clear	305.50	-	8

Roton Continuous Geared Hinges

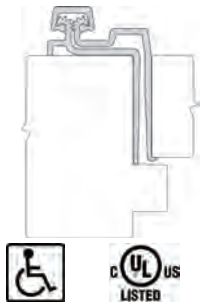

Description	Finish	2021 List	Stock No.	Case Qty.	
780-041HD Concealed Leaf Heavy Duty 1-3/4" Door Swing Clear Action	79" (2007 mm)	Clear	362.40	194918	6
		Dark Bronze	481.00	194919	
		Black	533.20	-	
	83" (2108 mm)	Clear	362.40	194803	6
		Dark Bronze	481.00	194920	
		Black	553.20	-	
	85" (2159 mm)	Clear	362.40	194921	6
		Dark Bronze	481.00	194923	
		Black	533.20	-	
	95" (2413 mm)	Clear	449.20	194805	6
		Dark Bronze	591.70	194924	
		Black	680.40	-	
	119" (3023 mm)	Clear	670.50	194925	2
		Dark Bronze	881.90	194926	
		Black	1,014.20	-	



780-041LL Concealed Leaf With Half Drill Quick and Half Wood Screws 1-3/4" Door Lead Lined Heavy Duty Profile Only Swing Clear Action	79" (2007 mm)	Clear	376.90	187432	6
		Dark Bronze	493.00	-	
		Black	567.00	-	
	83" (2108 mm)	Clear	376.90	022711	6
		Dark Bronze	493.00	073552	
		Black	567.00	-	
	85" (2159 mm)	Clear	376.90	095167	6
		Dark Bronze	493.00	-	
		Black	567.00	-	
	95" (2413 mm)	Clear	461.30	-	6
		Dark Bronze	603.70	-	
		Black	694.30	-	
	119" (3023 mm)	Clear	681.50	-	2
		Dark Bronze	894.00	-	
		Black	1,028.10	-	

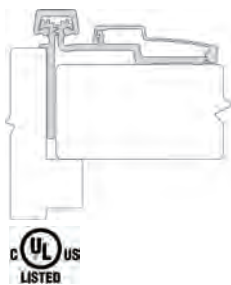

780-045HD Half Surface Heavy Duty	79" (2007 mm)	Clear	429.70	194937	4
		Dark Bronze	574.40	-	
		Black	660.60	-	
	83" (2108 mm)	Clear	429.70	194938	4
		Dark Bronze	574.40	194939	
		Black	660.60	-	
	85" (2159 mm)	Clear	429.70	194940	4
		Dark Bronze	574.40	194942	
		Black	660.60	-	
	95" (2413 mm)	Clear	528.20	194943	4
		Dark Bronze	706.50	194944	
		Black	812.40	47150	
	119" (3023 mm)	Clear	786.90	194945	2
		Dark Bronze	1,051.00	194947	
		Black	1,208.70	-	

1. Items with the price in **bold and red** are Quick Ship items and ship in 24 hours.
Please use stock number when ordering. 2. U/M is each unless otherwise noted.



Roton Continuous Geared Hinges

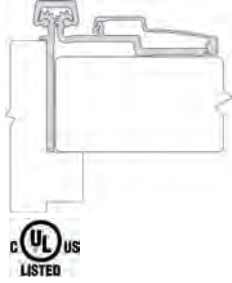

Description		Finish	2021 List	Stock No.	Case Qty.
780-046HD Half Surface Heavy Duty	79" (2007 mm)	Clear	462.50	194948	4
		Dark Bronze	606.70	-	
		Black	697.70	-	
	83" (2108 mm)	Clear	462.50	194949	4
		Dark Bronze	606.70	194950	
		Black	697.70	88082	
	85" (2159 mm)	Clear	462.50	194951	4
		Dark Bronze	606.70	197942	
		Black	697.70	-	
	95" (2413 mm)	Clear	567.10	194952	4
		Dark Bronze	754.10	194953	
		Black	867.20	-	
	119" (3023 mm)	Clear	847.20	99397	2
		Dark Bronze	1,122.70	81736	
		Black	1,291.10	-	
780-053 Half Surface	79" (2007 mm)	Clear	224.80	194464	5
		Dark Bronze	309.10	194990	
		Black	355.40	-	
	83" (2108 mm)	Clear	224.80	194991	5
		Dark Bronze	309.10	194992	
		Black	355.40	135666	
	95" (2413 mm)	Clear	278.50	194993	5
		Dark Bronze	376.70	194994	
		Black	433.20	199830	
780-053HD Half Surface Heavy Duty	79" (2007 mm)	Clear	282.00	194996	5
		Dark Bronze	353.70	194997	
		Black	406.80	66022	
	83" (2108 mm)	Clear	282.00	194998	5
		Dark Bronze	353.70	194999	
		Black	406.80	63779	
	85" (2159 mm)	Clear	282.00	195002	5
		Dark Bronze	353.70	195003	
		Black	406.80	-	
	95" (2413 mm)	Clear	349.90	195004	5
		Dark Bronze	423.90	195005	
		Black	487.50	199831	
119" (3023 mm)	Clear	535.60	195006	3	
	Dark Bronze	715.00	195007		
	Black	822.30	-		

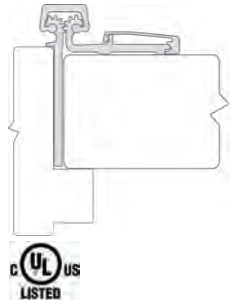
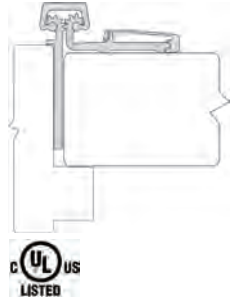

1. Items with the price in **bold and red** are Quick Ship items and ship in 24 hours.
Please use stock number when ordering. 2. U/M is each unless otherwise noted.

Roton Continuous Geared Hinges

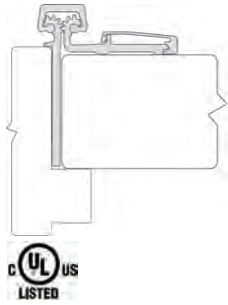

Description		Finish	2021 List	Stock No.	Case Qty.
780-054HD Half Surface Heavy Duty	79" (2007 mm)	Clear	308.00	195050	5
		Dark Bronze	378.80	195051	
		Black	435.60	-	
	83" (2108 mm)	Clear	308.00	195052	5
		Dark Bronze	378.80	195053	
		Black	435.60	80289	
	85" (2159 mm)	Clear	308.00	195054	5
		Dark Bronze	378.80	195055	
		Black	435.60	-	
	95" (2413 mm)	Clear	380.80	195056	5
		Dark Bronze	450.50	195057	
		Black	518.00	99659	
	119" (3023 mm)	Clear	585.80	195058	3
		Dark Bronze	756.10	195059	
		Black	869.50	72407	
780-057HD Full Surface Heavy Duty Bi-Fold Applications	79" (2007 mm)	Clear	329.00	021238	5
		Dark Bronze	464.60	017850	
		Black	534.30	-	
	83" (2108 mm)	Clear	329.00	007856	5
		Dark Bronze	464.60	025973	
		Black	534.30	-	
	85" (2159 mm)	Clear	329.00	025846	5
		Dark Bronze	464.60	174835	
		Black	534.30	-	
	95" (2413 mm)	Clear	418.30	024478	5
		Dark Bronze	575.20	094331	
		Black	661.50	-	
	119" (3023 mm)	Clear	623.50	088469	4
		Dark Bronze	856.70	165568	
		Black	985.20	-	
780-110HD Concealed Leaf Heavy Duty For 1" to 1-3/8" door	79" (2007 mm)	Clear	209.20	100071	8
		Dark Bronze	270.30	196487	
		Black	310.80	-	
	83" (2108 mm)	Clear	209.20	110418	8
		Dark Bronze	270.30	111266	
		Black	310.80	84514	
	85" (2159 mm)	Clear	209.20	112381	8
		Dark Bronze	270.30	173953	
		Black	310.80	63320	
	95" (2413 mm)	Clear	251.40	112392	8
		Dark Bronze	325.80	112393	
		Black	374.70	90279	
	119" (3023 mm)	Clear	398.20	112405	7
		Dark Bronze	522.90	112406	
		Black	601.40	91587	

1. Items with the price in **bold and red** are Quick Ship items and ship in 24 hours.
Please use stock number when ordering. 2. U/M is each unless otherwise noted.



Roton Continuous Geared Hinges



Description		Finish	2021 List	Stock No.	Case Qty.
780-111 Concealed Leaf	79" (2007 mm)	Clear	163.40	194809	8
		Dark Bronze	211.10	194810	
		Black	242.75	60918	
	83" (2108 mm)	Clear	163.40	184007	8
		Dark Bronze	211.10	184008	
		Black	242.75	80025	
	95" (2413 mm)	Clear	199.10	184031	8
		Dark Bronze	258.90	184048	
		Black	297.70	98769	

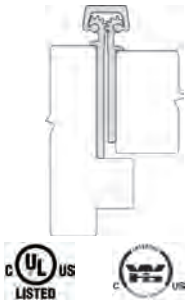

780-111HD Concealed Leaf Heavy Duty	79" (2007 mm)	Clear	203.30	183917	8
		Dark Bronze	265.50	194812	
		Black	305.40	-	
	83" (2108 mm)	Clear	203.30	183924	8
		Dark Bronze	265.50	183988	
		Black	305.40	116592	
	85" (2159 mm)	Clear	203.30	194814	8
		Dark Bronze	265.50	194815	
		Black	305.40	83711	
	95" (2413 mm)	Clear	246.80	184025	8
		Dark Bronze	319.20	194816	
		Black	367.10	109310	
	119" (3023 mm)	Clear	394.40	194817	7
		Dark Bronze	513.60	194819	
		Black	590.60	113845	

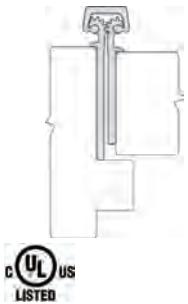

780-111LL Concealed Leaf With Half Drill Quick and Half Wood Screws Lead Lined Heavy Duty Profile Only	79" (2007 mm)	Clear	220.00	194848	8
		Dark Bronze	279.60	-	
		Black	321.60	-	
	83" (2108 mm)	Clear	220.00	195079	8
		Dark Bronze	279.60	195080	
		Black	321.60	-	
	85" (2159 mm)	Clear	220.00	-	8
		Dark Bronze	279.60	-	
		Black	321.60	-	
	95" (2413 mm)	Clear	261.50	195088	8
		Dark Bronze	333.20	195089	
		Black	383.20	-	
	119" (3023 mm)	Clear	405.00	-	7
		Dark Bronze	528.20	-	
		Black	607.50	-	

1. Items with the price in **bold and red** are Quick Ship items and ship in 24 hours.
Please use stock number when ordering. 2. U/M is each unless otherwise noted.

Roton Continuous Geared Hinges



Description		Finish	2021 List	Stock No.	Case Qty.
780-112 Concealed Leaf Single Pack w/ Drill Quick Screws	79" (2007 mm)	Clear	137.60	183922	8
		Dark Bronze	177.70	194822	
		Black	204.40	74006	
	83" (2108 mm)	Clear	137.60	184001	8
		Dark Bronze	177.70	184003	
		Black	204.40	136045	
	95" (2413 mm)	Clear	168.50	184032	7
		Dark Bronze	221.90	184033	
		Black	255.20	126429	



780-112 Concealed Leaf Case Pack w/ Drill Quick Screws Must Order Case Quantity	83" (2108 mm)	Clear	123.80	184009	8
		Dark Bronze	160.00	184010	
		Black	184.00	-	



780-112HD Concealed Leaf Single Pack w/ Drill Quick Screws	79" (2007 mm)	Clear	170.90	183881	8
		Dark Bronze	220.80	194826	
		Black	253.90	128859	
	83" (2108 mm)	Clear	170.90	183926	8
		Dark Bronze	220.80	183932	
		Black	253.90	110422	
	85" (2159 mm)	Clear	170.90	184011	8
		Dark Bronze	220.80	184013	
		Black	253.90	123296	
	95" (2413 mm)	Clear	205.90	184020	7
		Dark Bronze	271.50	184021	
		Black	312.20	123220	
	119" (3023 mm)	Clear	331.20	184038	7
		Dark Bronze	436.40	194827	
		Black	501.90	114187	

780-112HD Concealed Leaf Case Pack w/ Drill Quick Screws Must Order Case Quantity	83" (2108 mm)	Clear	156.40	109235	8
		Dark Bronze	198.80	80053	
		Black	228.60	183989	

780-112LL Concealed Leaf With Half Drill Quick and Half Wood Screws Lead Lined Heavy Duty Profile Only	79" (2007 mm)	Clear	188.50	195090	8
		Dark Bronze	246.40	-	
		Black	283.40	-	
	83" (2108 mm)	Clear	188.50	195091	8
		Dark Bronze	246.40	195092	
		Black	283.40	83861	
	85" (2159 mm)	Clear	188.50	195093	8
		Dark Bronze	246.40	-	
		Black	283.40	-	
	95" (2413 mm)	Clear	229.30	195094	8
		Dark Bronze	294.00	195095	
		Black	338.60	-	
	119" (3023 mm)	Clear	365.80	195096	7
		Dark Bronze	478.00	197874	
		Black	549.70	-	

1. Items with the price in **bold and red** are Quick Ship items and ship in 24 hours.
Please use stock number when ordering. 2. U/M is each unless otherwise noted.



Roton Continuous Geared Hinges

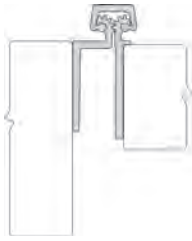

Description		Finish	2021 List	Stock No.	Case Qty.
780-113HD Concealed Leaf Heavy Duty "Safety Hinge" When Used Without Frame Stop	79" (2007 mm)	Clear	346.00	195097	6
		Dark Bronze	465.20	195098	
		Black	535.00	-	
	83" (2108 mm)	Clear	346.00	195099	6
		Dark Bronze	465.20	195100	
		Black	535.00	-	
	85" (2159 mm)	Clear	346.00	195101	6
		Dark Bronze	465.20	195102	
		Black	535.00	-	
	95" (2413 mm)	Clear	567.10	195103	6
		Dark Bronze	636.80	195104	
		Black	732.30	-	
	119" (3023 mm)	Clear	703.80	195105	4
		Dark Bronze	831.90	-	
		Black	956.70	-	

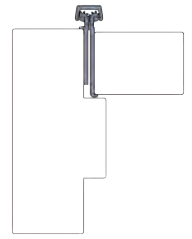

780-124HD Concealed Leaf Heavy Duty profile only Single Pack w/ Drill Quick Screws	79" (2007 mm)	Clear	173.70	194831	8
		Dark Bronze	226.20	194832	
		Black	260.20	-	
	83" (2108 mm)	Clear	173.70	183991	8
		Dark Bronze	226.20	194834	
		Black	260.20	140988	
	85" (2159 mm)	Clear	173.70	194835	8
		Dark Bronze	226.20	197391	
		Black	260.20	-	
	95" (2413 mm)	Clear	210.10	194836	7
		Dark Bronze	252.50	194837	
		Black	290.40	-	
	119" (3023 mm)	Clear	341.40	194838	7
		Dark Bronze	447.40	-	
		Black	514.50	-	

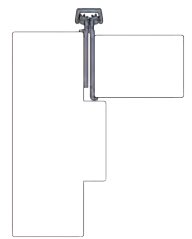

780-124LL Concealed Leaf Heavy Duty profile only With half drill quick and Half Wood Screws Lead Lined	79" (2007 mm)	Clear	195.90	55498	8
		Dark Bronze	252.50	-	
		Black	290.40	-	
	83" (2108 mm)	Clear	195.90	195114	8
		Dark Bronze	252.50	74529	
		Black	290.40	-	
	85" (2159 mm)	Clear	195.90	197934	8
		Dark Bronze	252.50	-	
		Black	290.40	-	
	95" (2413 mm)	Clear	235.30	75300	7
		Dark Bronze	296.90	-	
		Black	341.50	-	
	119" (3023 mm)	Clear	373.70	49286	7
		Dark Bronze	484.80	-	
		Black	557.50	-	



Roton Continuous Geared Hinges

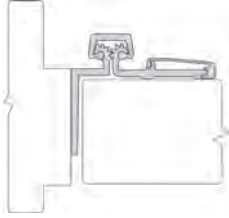

Description		Finish	2021 List	Stock No.	Case Qty.
780-155HD Half Surface Heavy Duty Center Hung and Egress Conversions	79" (2007 mm)	Clear	363.40	016603	5
		Dark Bronze	489.30	128736	
		Black	562.80	-	
	83" (2108 mm)	Clear	363.40	068088	5
		Dark Bronze	489.30	068371	
		Black	562.80	71061	
	85" (2159 mm)	Clear	363.40	018276	5
		Dark Bronze	489.30	046665	
		Black	562.80	-	
	95" (2413 mm)	Clear	445.90	063096	5
		Dark Bronze	603.30	056566	
		Black	693.80	196310	
	119" (3023 mm)	Clear	663.60	078745	2
		Dark Bronze	896.90	062632	
		Black	1,031.40	-	
780-157 Full Surface Frame Face Dimension Limitations	79" (2007 mm)	Clear	211.60	022092	5
		Dark Bronze	285.80	049196	
		Black	328.70	85841	
	83" (2108 mm)	Clear	211.60	048049	5
		Dark Bronze	285.80	063070	
		Black	328.70	159357	
	95" (2413 mm)	Clear	258.70	021262	5
		Dark Bronze	349.10	009045	
		Black	401.40	170884	

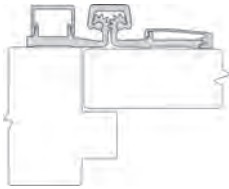

1. Items with the price in **bold and red** are Quick Ship items and ship in 24 hours.
Please use stock number when ordering. 2. U/M is each unless otherwise noted.



Roton Continuous Geared Hinges

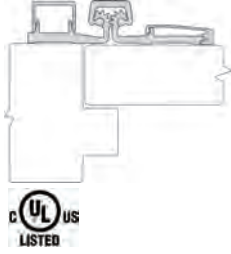

Description		Finish	2021 List	Stock No.	Case Qty.
780-157HD Full Surface Heavy Duty Frame Face Dimension Limitations	79" (2007 mm)	Clear	262.20	022028	5
		Dark Bronze	319.70	084386	
		Black	367.70	94867	
	83" (2108 mm)	Clear	262.20	048059	5
		Dark Bronze	319.70	062422	
		Black	367.70	36598	
	85" (2159 mm)	Clear	262.20	019546	5
		Dark Bronze	319.70	035156	
		Black	367.70	188600	
	95" (2413 mm)	Clear	314.60	048060	5
		Dark Bronze	384.10	010547	
		Black	441.70	112593	
	119" (3023 mm)	Clear	521.40	099644	2
		Dark Bronze	678.80	037141	
		Black	780.60	189834	
780-210 Full Surface	79" (2007 mm)	Clear	211.60	010064	6
		Dark Bronze	285.80	073030	
		Black	328.70	60919	
	83" (2108 mm)	Clear	211.60	048050	6
		Dark Bronze	285.80	048051	
		Black	328.70	45510	
	95" (2413 mm)	Clear	253.20	063037	6
		Dark Bronze	344.90	020588	
		Black	396.60	068541	

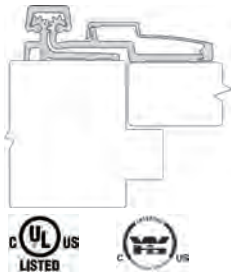

1. Items with the price in **bold and red** are Quick Ship items and ship in 24 hours.
Please use stock number when ordering. 2. U/M is each unless otherwise noted.

Roton Continuous Geared Hinges



Description	Finish	2021 List	Stock No.	Case Qty.
780-210HD Full Surface Heavy Duty	79" (2007 mm) Clear	258.20	017046	6
	Dark Bronze	313.90	017037	
	Black	361.00	177093	
	83" (2108 mm) Clear	258.20	048061	6
	Dark Bronze	313.90	048062	
	Black	361.00	93405	
	85" (2159 mm) Clear	258.20	024124	6
	Dark Bronze	313.90	071974	
	Black	361.00	-	
95" (2413 mm) Clear	304.80	048063	6	
Dark Bronze	375.00	046722		
Black	431.20	154984		
119" (3023 mm) Clear	509.80	025722	2	
Dark Bronze	571.40	000304		
Black	657.10	165971		



780-211HD Half Surface Heavy Duty Frame Leaf Wrap-Around Reinforcement for Damaged Frames	79" (2007 mm) Clear	508.20	195201	4
	Dark Bronze	667.70	198388	
	Black	767.90	-	
	83" (2108 mm) Clear	508.20	195202	4
	Dark Bronze	667.70	195203	
	Black	767.90	-	
	85" (2159 mm) Clear	508.20	195204	4
	Dark Bronze	667.70	195205	
	Black	767.90	-	
	95" (2413 mm) Clear	625.40	195207	4
	Dark Bronze	821.80	146310	
	Black	945.10	-	
	119" (3023 mm) Clear	931.70	195208	2
	Dark Bronze	1,224.60	53808	
	Black	1,408.30	-	

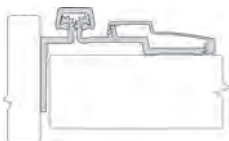

780-213HD Half Surface Heavy Duty Center Hung Doors	79" (2007 mm) Clear	481.30	195209	4
	Dark Bronze	635.50	195210	
	Black	730.80	-	
	83" (2108 mm) Clear	481.30	195211	4
	Dark Bronze	635.50	195212	
	Black	730.80	-	
	85" (2159 mm) Clear	481.30	195213	4
	Dark Bronze	635.50	195216	
	Black	730.80	-	
	95" (2413 mm) Clear	590.60	195217	4
	Dark Bronze	781.60	195218	
	Black	898.80	-	
	119" (3023 mm) Clear	880.10	195219	2
	Dark Bronze	1,164.90	195220	
	Black	1,339.60	-	

1. Items with the price in **bold and red** are Quick Ship items and ship in 24 hours.
Please use stock number when ordering. 2. U/M is each unless otherwise noted.



Roton Continuous Geared Hinges

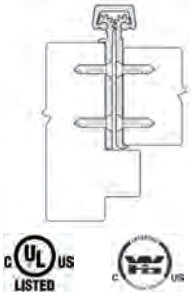

Description		Finish	2021 List	Stock No.	Case Qty.
780-224 Concealed Leaf 1-3/4" Doors Single Pack w/ Drill Quick Screws	79" (2007 mm)	Clear	139.30	183923	7
		Dark Bronze	181.70	194839	
		Black	209.00	-	
	83" (2108 mm)	Clear	139.30	184005	7
		Dark Bronze	181.70	184006	
		Black	209.00	90379	
	95" (2413 mm)	Clear	176.60	184036	7
		Dark Bronze	228.30	194840	
		Black	262.50	198251	

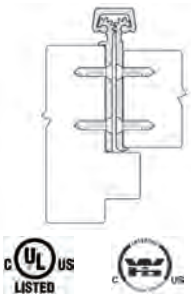

780-224 Bulk Pack Concealed Leaf 1-3/4" Doors Case Pack w/ Drill Quick Screws Must Order Case Quantity	83" (2108 mm)	Clear	125.30	194841	7
---	---------------	-------	--------	--------	---

780-224HD Concealed Leaf 1-3/4" Doors Single Pack w/ Drill Quick Screws	79" (2007 mm)	Clear	173.80	183882	7
		Dark Bronze	226.00	183921	
		Black	259.90	67150	
	83" (2108 mm)	Clear	173.80	184122	7
		Dark Bronze	226.00	183973	
		Black	259.90	183992	
	85" (2159 mm)	Clear	173.80	184012	7
		Dark Bronze	226.00	184014	
		Black	259.90	199457	
	95" (2413 mm)	Clear	210.50	184022	7
		Dark Bronze	277.20	184023	
		Black	318.80	195809	
	119" (3023 mm)	Clear	344.90	184039	5
		Dark Bronze	449.00	194842	
		Black	516.40	195810	

780-224HD Concealed Leaf 1-3/4" Doors Case Pack w/ Drill Quick Screws Must Order Case Quantity	83" (2108 mm)	Clear	156.40	194828	7
		Dark Bronze	203.50	194829	
		Black	234.00	90247	

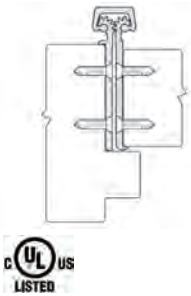

780-224LL Concealed Leaf 1-3/4" Doors Lead Lined With Half Drill Quick and Half Wood Screws Heavy Duty Profile Only	79" (2007 mm)	Clear	200.70	195181	7
		Dark Bronze	256.10	195221	
		Black	294.60		
	83" (2108 mm)	Clear	200.70	195184	7
		Dark Bronze	256.10	195222	
		Black	294.60	53872	
	85" (2159 mm)	Clear	200.70	195223	7
		Dark Bronze	256.10	-	
		Black	294.60	-	
	95" (2413 mm)	Clear	242.70	195224	7
		Dark Bronze	298.80	195225	
		Black	343.60	-	
	119" (3023 mm)	Clear	381.70	195226	5
		Dark Bronze	492.00	-	
		Black	565.80	-	

1. Items with the price in **bold and red** are Quick Ship items and ship in 24 hours.
Please use stock number when ordering. 2. U/M is each unless otherwise noted.

Roton Continuous Geared Hinges



Description	Size	Finish	2021 List	Stock No.	Case Qty.	
780-226HD Concealed Leaf Heavy Duty For Doors 2" or Thicker	79" (2007 mm)	Clear	207.90	194843	7	
		Dark Bronze	274.20	194844		
		Black	315.40	-		
	Concealed Leaf Heavy Duty For Doors 2" or Thicker	83" (2108 mm)	Clear	207.90	183974	7
			Dark Bronze	274.20	194845	
			Black	315.40	195812	
	85" (2159 mm)	Clear	207.90	194846	7	
		Dark Bronze	274.20	194849		
		Black	315.40	67532		
95" (2413 mm)	Clear	253.00	184024	7		
	Dark Bronze	325.30	194850			
	Black	374.10	195813			
119" (3023 mm)	Clear	410.90	193587	5		
	Dark Bronze	533.70	194851			
	Black	613.70	195815			



780-226LL Concealed Leaf For Lead Lined Doors 2" or Thicker With Half Drill Quick and Half Wood Screws Heavy Duty Profile Only	79" (2007 mm)	Clear	225.30	195229	7
		Dark Bronze	287.00	195233	
		Black	330.00	-	
	83" (2108 mm)	Clear	225.30	195235	7
		Dark Bronze	287.00	95797	
		Black	330.00	-	
	85" (2159 mm)	Clear	225.30	143304	7
		Dark Bronze	287.00	-	
		Black	330.00	-	
	95" (2413 mm)	Clear	272.30	195236	7
		Dark Bronze	327.20	195237	
		Black	376.30	-	
119" (3023 mm)	Clear	427.70	195238	5	
	Dark Bronze	551.00	195239		
	Black	633.70	-		

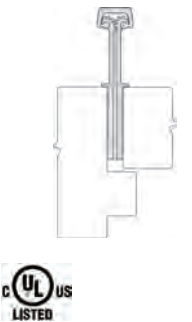

780-235HD Concealed Leaf Heavy Duty Wide Throw	83" (2108 mm)	Clear	483.40	125582	1
		Dark Bronze	632.80	141654	
		Black	727.70	198301	
	95" (2413 mm)	Clear	596.60	129916	1
		Dark Bronze	760.10	199537	
		Black	874.10	198678	

1. Items with the price in **bold and red** are Quick Ship items and ship in 24 hours.
Please use stock number when ordering. 2. U/M is each unless otherwise noted.



Roton Continuous Geared Hinges



Description	Size	Finish	2021 List	Stock No.	Case Qty.
780-257HD Full Surface Heavy Duty Double hinge for hanging two doors from a fixed mullion.	79" (2007 mm)	Clear	505.50	-	2
		Dark Bronze	694.50	-	
		Black	798.60	-	
	83" (2108 mm)	Clear	505.50	081899	2
		Dark Bronze	694.50	159250	
		Black	798.60	189136	
	85" (2159 mm)	Clear	505.50	112767	2
		Dark Bronze	694.50	158749	
		Black	798.60	-	
	95" (2413 mm)	Clear	622.10	028146	2
		Dark Bronze	854.00	161153	
		Black	982.10	-	
	119" (3023 mm)	Clear	927.60	162543	2
		Dark Bronze	1,272.90	179221	
		Black	1,463.80	-	
780-300HD Half Surface Heavy Duty Center Hung Applications	79" (2007 mm)	Clear	360.80	010212	4
		Dark Bronze	490.10	019206	
		Black	563.10	-	
	83" (2108 mm)	Clear	360.80	047819	4
		Dark Bronze	490.10	057968	
		Black	563.10	22490	
	85" (2159 mm)	Clear	360.80	061937	4
		Dark Bronze	490.10	038063	
		Black	563.10	-	
	95" (2413 mm)	Clear	443.80	047821	4
		Dark Bronze	602.10	047822	
		Black	692.40	83347	
	119" (3023 mm)	Clear	661.00	015052	2
		Dark Bronze	898.20	011244	1/1/2021
		Black	1,033.00	92138	

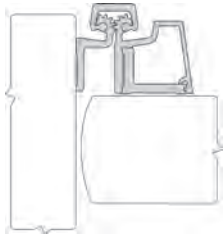

Roton Continuous Geared Hinges

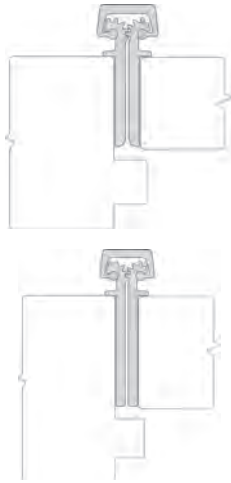

Description	Size	Finish	2021 List	Stock No.	Case Qty.
1200-600XHD Concealed Leaf Extra Heavy Duty For doors from 1-3/4" to 2-3/8" thick.	83" (2108 mm)	Clear	1,047.00	000590	1
		Dark Bronze	1,465.00	028601	
	95" (2413 mm)	Clear	1,186.25	004040	1
		Dark Bronze	1,605.00	065709	
	119" (3023 mm)	Clear	1,326.00	090770	1
		Dark Bronze	1,744.00	107206	
1200-650XHD Concealed Leaf Extra Heavy Duty For doors 2-3/8" thick or thicker.	83" (2108 mm)	Clear	1,396.00	090353	1
		Dark Bronze	1,814.00	135473	
	95" (2413 mm)	Clear	1,535.00	090439	1
		Dark Bronze	1,954.00	108903	
	119" (3023 mm)	Clear	1,675.00	090440	1
		Dark Bronze	2,093.00	044852	

1. Items with the price in **bold and red** are Quick Ship items and ship in 24 hours.
Please use stock number when ordering. 2. U/M is each unless otherwise noted.



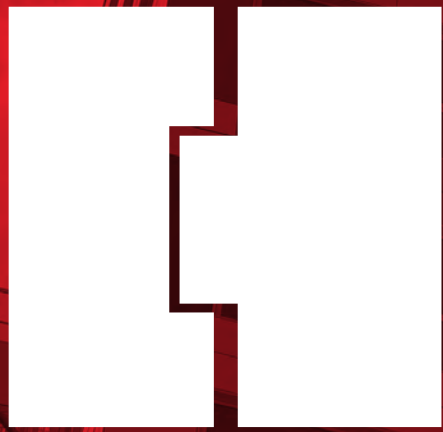

HAGER[®]

COMPANIES

TABLE OF CONTENTS

A		M	
ANSI Standards.....	2	Mortar Box.....	5
C		N	
Cancellation Notification	2	No Hole (Blank) Hinges	2
Concealed Electric Through-Wire.....	4-5	P	
Custom Hole Pattern	2	Powder Coat	3
Custom Length Hinges	2	Q	
D		Quick Connect.....	5
Dutch Door Hinges	3	Quick Ship.....	2
E		R	
Electrical Modifications Standard Locations.....	4	Raised Barrel.....	3
Electric Power Transfer Preparations (EPT).....	5	Replacement Moldings	3
Exposed Electric Switches	5	S	
Extra Long Hinges.....	2	Security Fasteners.....	3
F		Security Studs.....	3
Fasteners.....	4	Sheared Leaf	3
Fire Rating	2	Standard Lengths.....	2
H		T	
Hinges		Tamper Resistant Hospital Tips	3
Concealed Leaf	6-7	W	
Full Surface	7	Wide Throw	3
Half Surface	6		
Half Mortise	6		
How To Order.....	1		
L			
Lead Times.....	2		
Lead Lined.....	2		

HOW TO ORDER:

Example: 790-900 83 1/8" US32D 1 PK

Stock Number: 23243

Item Number: PS90083B32D000001

790

STAINLESS
STEEL
CONTINUOUS
HINGE

900

ITEM#

83

LENGTH

1/8"

FRACTION

US32D

FINISH

1 PK

STANDARD
SINGLE
PACK



Stainless Steel Continuous Hinges

ANSI Standards

790 Series stainless steel continuous hinges are approved for ANSI A156.26 Grade 1 for 150-pound doors.

Fire Rating

Hager 790 Series hinges are approved by Underwriters Laboratories, Inc. Fire Rated label for up to 3 hours for metal doors and 90 minutes for wood composite doors.



Lead Times

Stock items will typically ship in five working days or less from the order entry date. Made-to-order items will typically ship in 15 working days depending on seasonal volume and order complexity. Special orders including industrials, special machining, and large quantities may need to be scheduled. The anticipated ship date will be included with each order acknowledgement. Please contact Customer Service if product availability is in question.

Quick Ship

Products denoted with **red and bold** pricing are available to order through the Quick Ship program and ship within 24 hours. When ordering these products please visit www.hagerco.com and log in to MyHager to access the 'Quick Ship' portal. Due to the promptness of the fulfillment process, Quick Ship orders are non-cancellable.

Cancellation Notification

Cancellation for made-to-order items must be communicated within 48 hours of order placement.

Standard Lengths

Stainless steel hinges are listed and priced as actual lengths 83-1/8" (7'0" opening), 85" (7'2" opening), 95" (8'0" opening), and 119" (10'0" opening) for convenience in application to nominal sized doors. Other lengths may be ordered as non-standard items.

Extra Long Hinges

Hinges over 119" are manufactured as two separate lengths with staggered joints for on-site connection.

MODIFICATIONS & ADDITIONS PRICE

ADDITION TO LIST

Custom Length Hinges

Actual door height may be specified at an additional charge outlined:

- For hinges 40" to 83" in length **\$71.60** to 7' list price.
- For hinges 83" to 95" in length **\$71.60** to 8' list price.
- For hinges 95" to 119" in length **\$71.60** to 10' list price.
- For hinges 119" to 192" in length **\$163.80** to the list price.

Custom Hole Pattern

- Any hole pattern or shape other than Hager's standard hole pattern.

Price on Application

No Hole (Blank) Hinges

- Holes omitted for special applications (i.e. welded installation).

Price on Application

Lead Lined Hole Pattern

- Only available on Models 790-900, 790-911 and 790-915.

Price on Application



MODIFICATIONS & ADDITIONS PRICE

ADDITION TO LIST

Powder Coat

- Available in aluminum, dark bronze, satin bronze, satin brass, black, or white. Lead time of up to 8-10 weeks may be required.

Price on Application

Tamper Resistant Hospital Tips (HT)

- Custom lengths
- Available on concealed leaf models 790-900, 790-905, 790-907, 790-915, for standard lengths.

\$119.40

Price on Application

Dutch Door Prep (DUTCH)

- Furnished as a continuous frame leaf while door leaf is cut to fit dutch door specified height.

\$119.40

Wide Throw

- Specify distance from pin centerline to heel edge of hinge.

Price on Application

Raised Barrel (SWAGED)

- Available on concealed and half surface models.

Price on Application

Sheared Leaf

- Available on all models except 790-904 and 790-906.
- Specify distance from pin centerline to extreme edge of hinge when ordering.

Price on Application

Security Studs

- Stainless steel security studs mounted through frame leaf into door frame.
- Door and frame must be specifically prepped to accommodate security studs.
- Door leaf is drilled to accommodate studs.

\$84.00

Replacement Moldings (M)

Hinge lengths:

79", 83", 85"

95"

119"

\$176.50

\$190.80

\$208.90



- Shipped in stock lengths for trimming in the field.
- Brush aluminum & furnished with 5 each molding clips, 5 each 1/4"-14 x 1" panhead 2C screws.
- Available on models 790-903, 790-904, 790-906 and 790-909.

Security Fasteners

- Torx and Spanner Head available in place of standard fasteners.

\$85.90



Stainless Steel Continuous Hinges

MODIFICATIONS & ADDITIONS

Additional Fasteners

#10-24 x 5/8" Torx Head Machine Screw	\$3.00 /ea
#10-16 x 1-1/4" Thread Forming Flat Head Screw	\$1.30 /ea
1/4"-14 x 1" Thread Forming Pan Head Screw	\$1.90 /ea
#10-24 x 5/8" Self-Drilling Flat Head Screw	\$1.90 /ea
1/4"-20 x 3/4" Self-Drilling Pan Head Screw	\$1.65 /ea
Adjustment Stud With Flat Head Screw	\$9.10 /ea
Sexbolt and Nut	\$5.65 /ea

STANDARD LOCATIONS FOR ELECTRICAL MODIFICATIONS

	79"	83"	85"	95"	119"
Opening	80"	84"	86"	96"	120"
Door Height	79-1/8"	83-1/8"	85-1/8"	95-1/8"	119-1/8"
Hinge Length	79-3/16"	83-1/8"	85-1/8"	95"	118-3/4"
ETW	41-1/2"	43-1/2"	45-1/2"	55-3/8"	79-1/8"
EPT	24-1/2"	28-7/16"	30-7/16"	40-1/2"	64-7/16"
E1S	41-1/2"	43-1/2"	45-1/2"	55-3/8"	79-1/8"

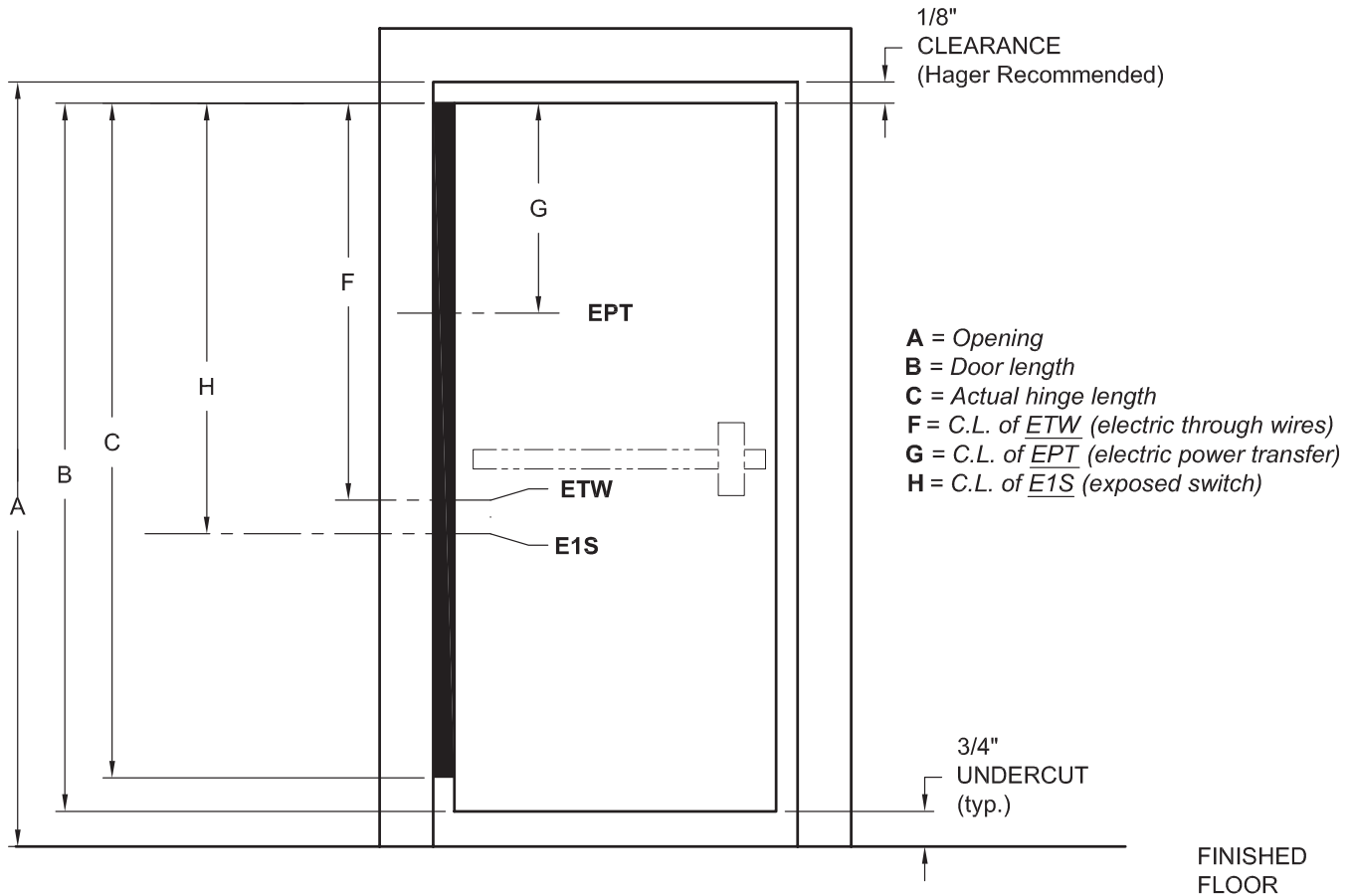

MODIFICATIONS & ADDITIONS PRICE

ADDITION TO LIST

Quick Connect

Available for ETW.

\$47.90

Electric Power Transfer Preparations (EPT)

\$136.80

- Hinge leaf cutout to accommodate power transfer device.
- Specify handing and dimension from top of hinge to centerline of power transfer cutout location. Please note the clearance from top of hinge to underside of header, typically 1/16" to 1/8" (1.6 mm to 3.2 mm).
- Available on models 790-900, 790-903, 790-904, and 790-915.

Exposed Electric Switches (E1S)

\$210.60

- Each monitoring hinge only needs one E1S switch.
- Specify handing and dimension from top of hinge to centerline of electric switch.
- Miniature push button switch is incorporated in the hinge frame leaf to monitor position of the door.

Concealed Electric Through-Wire (ETW)

Electric Through Wire	ETW - 4	\$608.60
Electric Through Wire	ETW - 8	\$910.30
Electric Through Wire	ETW - 10	\$1,227.50

- 24-gauge 12" wire leads available on 790-900 and 790-915.
- Transfers power discretely from building to door hardware.
- Specify handing and dimension from top of hinge to centerline of electric through-wire location. Please note the clearance from top of hinge to underside of header, typically 1/16" to 1/8" (1.6 mm to 3.2 mm).

Mortar Box - 430

\$47.90

- Serves as mortar shield.
- Top and bottom knockouts for standard conduit fittings.
- Overall dimensions are 9" (229 mm) length with tabs 7" (178 mm). Inside is 1-3/4" x 1-3/4" (45 mm x 45 mm).
- Galvanized steel .040" (1 mm).



Stainless Steel Continuous Hinges

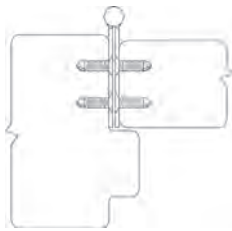

Description		Finish	2021 List	Stock No.	Case Qty.
790-900 Concealed Leaf, 1/8" Inset Door of Any Material	79" (2007 mm)	US32D	457.00	27336	1
	83" (2108 mm)	US32D	457.00	23243	1
	85" (2159 mm)	US32D	520.00	27921	1
	95" (2413 mm)	US32D	520.00	23250	1
	119" (3023 mm)	US32D	762.00	23251	1

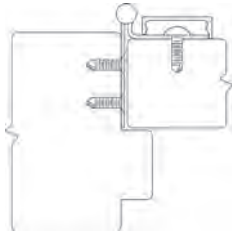

790-903 Half Surface, 1/8" Inset Door of Any Material Optional sex bolts available (specify when ordering).	79" (2007 mm)	US32D	525.00	42721	1
	83" (2108 mm)	US32D	525.00	23254	1
	85" (2159 mm)	US32D	609.00	53025	1
	95" (2413 mm)	US32D	609.00	23256	1
	119" (3023 mm)	US32D	777.00	23260	1

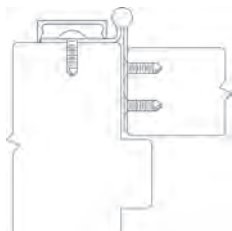

790-904 Half Mortise, 1/8" Inset Door of Any Material	79" (2007 mm)	US32D	531.00	71952	1
	83" (2108 mm)	US32D	531.00	52990	1
	85" (2159 mm)	US32D	636.00	92025	1
	95" (2413 mm)	US32D	636.00	52993	1
	119" (3023 mm)	US32D	825.00	-	1

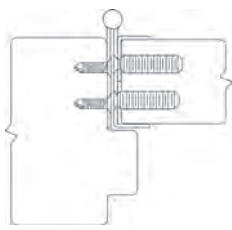

790-905 Concealed Leaf, 1/8" Inset Door of Any Material	79" (2007 mm)	US32D	588.00	65223	1
	83" (2108 mm)	US32D	588.00	23266	1
	85" (2159 mm)	US32D	672.00	36876	1
	95" (2413 mm)	US32D	672.00	23265	1
	119" (3023 mm)	US32D	1,003.00	23267	1

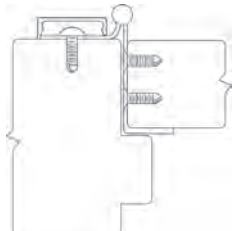

790-906 Half Mortise, Edge Guard Door of Any Material	79" (2007 mm)	US32D	531.00	92102	1
	83" (2108 mm)	US32D	531.00	92103	1
	85" (2159 mm)	US32D	636.00	92105	1
	95" (2413 mm)	US32D	636.00	92107	1
	119" (3023 mm)	US32D	825.00	92110	1

Stainless Steel Continuous Hinges

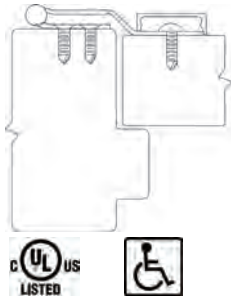

Description		Finish	2021 List	Stock No.	Case Qty.
790-909 Full Surface, 1/8" Inset Swing Clear Door of Any Material Optional sex bolts available (specify when ordering).	79" (2007 mm)	US32D	636.00	38978	1
	83" (2108 mm)	US32D	636.00	23270	1
	85" (2159 mm)	US32D	730.00	47643	1
	95" (2413 mm)	US32D	730.00	23271	1
	119" (3023 mm)	US32D	935.00	23279	1

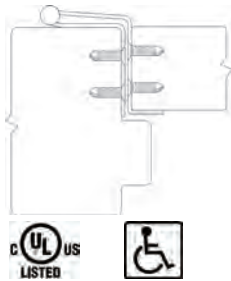

790-911 Concealed Leaf Swing Clear Door of Any Material	79" (2007 mm)	US32D	662.00	9412	1
	83" (2108 mm)	US32D	662.00	23284	1
	85" (2159 mm)	US32D	678.00	89831	1
	95" (2413 mm)	US32D	678.00	23285	1
	119" (3023 mm)	US32D	1,035.00	23286	1

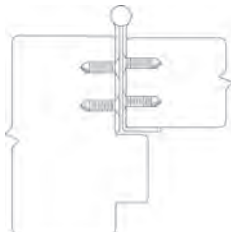

790-915 Concealed Leaf, 1/16" Inset Door of Any Material	79" (2007 mm)	US32D	552.00	33963	1
	83" (2108 mm)	US32D	552.00	23287	1
	85" (2159 mm)	US32D	625.00	40111	1
	95" (2413 mm)	US32D	625.00	23288	1
	119" (3023 mm)	US32D	930.00	23289	1

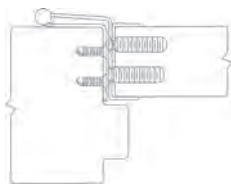

790-926 Concealed Leaf Swing Clear Door of Any Material	79" (2007 mm)	US32D	820.00	45597	1
	83" (2108 mm)	US32D	820.00	26760	1
	85" (2159 mm)	US32D	924.00	50336	1
	95" (2413 mm)	US32D	924.00	26761	1
	119" (3023 mm)	US32D	1,120.00	26762	1



1. Items with the price in **bold and red** are Quick Ship items and ship in 24 hours.
Please use stock number when ordering. 2. U/M is each unless otherwise noted.





H **HAGER**[®]
COMPANIES

TABLE OF CONTENTS

A

Accessories, 4500 Series Grade 1

Alarm Kit	25
Alarm Kit Latchbolt Monitor Switch.....	28
Alarm Kit Tamper Switch.....	29
Concealed Vertical Rod Bottom Latch Assembly.....	29
Concealed Vertical Rod Top Latch Assembly	29
Cylinder Cup Spacer 45PN/47PN	29, 47
Cylinder Dogging Conversion Kit.....	23
End Cap Replacement Packs (4500/4600 standard & flush)	26-27
Extension Rod Kit - 24"	25
Extension Rod Kit - 36"	25
Hex Key for Dogging.....	29
Less Bottom Rod Fire Bolt Kit.....	28
Less Bottom Rod Replacement Head Cover Plug	28
Photoluminescent Push Bar	29
Replacement Head Covers.....	24-25
Rod to Rod Connector	28
Rod Guide Replacement Pack.....	26
Spring Cage/Hanging Pin Replacement Pack.....	27
Surface Vertical Rod Top Latch Assembly.....	24
Surface Vertical Rod Bottom Latch Assembly	23
Screwpacks	27-28
Top or Bottom Latch Cover Replacement Pack	27
Top or Bottom Rod Replacement Kits.....	24

Accessories, 4600 Series Grade 1 Narrow Stile

Alarm Kit	36
Alarm Kit Latchbolt Monitor Switch.....	36
Alarm Kit Tamper Switch.....	37
Cylinder Dogging Conversion Kit.....	35
End Cap Replacement Packs (standard and flush).....	37
Hex Key for Dogging.....	37
Rim Replacement Head Cover	37

Accessories, 4700 Series Standard Duty

Bottom Latch Assembly.....	44
Bottom Latch Cover	46
Cylinder Cup Spacer 45PN/47PN	29, 47
End Cap Replacement Pack.....	47
Extension Rod Kit - 24"	45
Extension Rod Kit - 36"	45
Hex Key for Dogging.....	47
Replacement Dogging Plates.....	45
Replacement Head Covers	45
Rod to Rod Connector	47
Rod Guide Replacement.....	47
Screwpacks	46, 47
Top Latch Assembly	44
Top Latch Cover.....	46

Top or Bottom Rod Replacement Kit	45-46
Trim Hanging Pin.....	46

C

Cylinders

Cylinder Collar, 4500 Trim	49-50
Cylinder Collar, 4700 Trim	51
Mortise.....	50
Retaining Cup.....	50
Rim.....	49

E

Exit Devices, Grade 1

How to Order	6
4500 Rim Device	9
4500 Mortise Lock Exit Device.....	12-13
4500 Concealed Vertical Rod Device	11
4500 Concealed Vertical Rod Device Less Bottom Rod	12
4500 Dummy Push Pad Device.....	13
4500 Surface Vertical Rod Device.....	10
4500 Surface Vertical Rod Device Less Bottom Rod	9
4500 Electric Modifications, Power Supplies, and Alarmed Devices	4-5

Exit Devices, Grade 1 Narrow Stile

How to Order	7
4600 Narrow Stile Rim Device	30
4600 Concealed Vertical Rod Device	30
4600 Concealed Vertical Rod Device Less Bottom Rod	31
4600 Electric Modifications, Power Supplies, and Alarmed Devices	4-5
4500/4600 Dummy Push Pad Device	13

Exit Devices, Grade 1

How to Order	8
4700 Rim Device	39
4700 Surface Vertical Rod Device	39

M

Mullions

Mullion Set - Keyed Removable.....	48
Mullion Set - Non-Keyed Removable	48
Mullion Tube - Keyed Removable	49
Mullion Tube - Non-Keyed Removable	48
Stabilizer - Keyed Removable.....	49
Stabilizer - Non-Keyed Removable	48
Top/Bottom Bracket Set - Keyed Removable.....	49



Exit Devices

S

Shim Kit, 4500 Series Grade 1

Shim Kit, Rim Device.....	24
Shim Kit, Surface Vertical Rod.....	24

Shim Kit, 4600 Series Grade 1 Narrow Stile

Shim Kit, Narrow Stile Rim Device.....	36
--	----

Shim Kit, 4700 Series Standard Duty

Shim Kit, Rim Device.....	45
Shim Kit, Surface Vertical Rod.....	45

Strikes, 4500 Series Grade 1

Concealed Vertical Rod, Top Strike, Fire Rated.....	26
Concealed Vertical Rod, Top Strike, Standard.....	26
Double Door Strike, Standard.....	22
Mortise Device, Fire Rated.....	29
Mortise Device, Standard.....	29
Mullion, Strikes.....	48, 49
Rim Device, Fire Rated.....	22
Rim Device, Standard.....	22
Surface Vertical Rod, Bottom Strike, Fire Rated.....	23
Surface Vertical Rod, Bottom Strike, Standard.....	23
Surface Vertical Rod, Top Strike, Fire Rated.....	23
Surface Vertical Rod, Top Strike, Standard.....	23
Threshold Strike, Standard.....	22

Strikes, 4600 Series Grade 1 Narrow Stile

Blade Stop.....	36
Rim, Fire Rated.....	36
Rim, Standard.....	36
Semi-Flush Mount.....	36
Single Rabbet.....	36

Strikes, 4700 Series Standard Duty

Double Door Strike, Standard.....	43
Mullion, Strikes.....	48, 49
Rim Device, Standard.....	43
Surface Vertical Rod, Bottom Strike, Standard.....	43
Surface Vertical Rod, Top Strike, Standard.....	43
Threshold Strike, Standard.....	43

T

Trim, 4500 Series Grade 1

Anti-Vandal Pull.....	22
Blank Escutcheon.....	13-14
Blank Escutcheon, Mortise.....	14-15
Cylinder Escutcheon.....	15-16
Cylinder Escutcheon, Mortise.....	16-17
Dummy Trim.....	17-18
Dummy Trim, Mortise.....	18-19
Night Latch.....	19-20
Night Latch, Mortise.....	20-21
Pull Plate Trim.....	21

Trim, 4600 Series Grade 1 Narrow Stile

Blank Escutcheon.....	32
Cylinder Escutcheon.....	32-33
Dummy Trim.....	33
Night Latch.....	34-35
Night Lever.....	34

Trim, 4700 Series Standard Duty

Blank Escutcheon.....	39
Cylinder Escutcheon.....	40
Dummy Trim.....	40
Key-In-Lever Trim.....	42
Night Latch.....	41
Pull Plate Trim.....	43
Raised Lip - Dummy.....	44
Raised Lip - Night Latch.....	44

INTRODUCTION

Every model in Hager's line of exit devices is designed and engineered to assure you and your customers years of superior performance. Hager exit devices use fewer moving parts and are constructed with high-quality features.

Hager exit devices were designed with ease of installation in mind. We package our exit devices for convenience and versatility, with thru-bolts included for every model, slotted strikes, and non-handed designs. Hager offers escutcheon trim available in four functions, along with many other trim options.

Quick Ship

Products denoted with **red and bold** pricing are available to order through the Quick Ship program and ship within 24 hours. When ordering these products please visit www.hagerco.com and log in to MyHager to access the 'Quick Ship' portal. Due to the promptness of the fulfillment process, Quick Ship orders are non-cancellable.

Lead Times

Stock items will typically ship in five working days or less from the order entry date. Made-to-order items will typically ship in 15 working days depending on seasonal volume and order complexity. Special orders including industrials, special machining, and large quantities may need to be scheduled. The anticipated ship date will be included with each order acknowledgement. Please contact Customer Service if product availability is in question.

Cancellation Notification

Cancellation for made-to-order items must be communicated within 48 hours of order placement.

New Finish

Painted flat black finish (BHMA 693) is now available. Use BLK to designate finish. Extended lead time and MOQ may apply.



Exit Devices

ELECTRIC MODIFICATIONS - For use with 4500 Series and 4600 Series exit devices

FUNCTION	FUNCTION #	DESCRIPTION	ADD TO LIST PRICE
Electric Dogging	ED	Provides continuous latch retraction and dogging simultaneously.	\$743.60
Request to Exit	RX	Used to shunt an alarm, activate an alarm, provide release of magnetic locks, or signal a console.	\$299.20
Electric Dogging with Request to Exit	EDRX	Provides continuous latch retraction and dogging simultaneously along with an SPDT switch.	\$899.70
Dual Request to Exit	RX2	Features two SPDT switches.	\$359.25
Latchbolt Monitoring	LM	An internal SPDT switch that monitors the latchbolt to signal both egress and access of an opening.	\$299.20
Latchbolt Monitoring/ Request to Exit	RXLM	Two internal SPDT switches that monitor the latchbolt and the pushbar simultaneously.	\$371.25
Electric Trim*	ET*	Provides the means of locking or unlocking outside lever trim controls remotely. Trim works with both 12V or 24V and is field selectable between Fail Safe and Fail Secure.	\$551.40
Authorized Ingress/Key Monitoring*	AI*	An internal SPDT switch that monitors the operation of the outside trim. Must be ordered with the device.	\$311.20
Request to Exit/Authorized Ingress*	RXAI*	Two internal SPDT switches that monitors the pushbar and outside trim simultaneously. Must be ordered with the device.	\$371.25
Delayed Egress	DE	Delays egress for 15 or 30 seconds when unauthorized egress is initiated. Wall mount controller (2-679-0630) provides digital countdown display with verbal instructions or alarm tone only and must be ordered separately, list price \$1,404.50. Requires 3902 Mortise Cylinder, 1-1/8" long. Longer cylinders can be used with a collar.	\$1,310.00
Onboard Delayed Egress	OBDE*	Delays egress for 15 seconds (30 seconds optional) when unauthorized egress is initiated. Modification can be made to 4501 or 4601 exit devices. Requires 3902 Mortise Cylinder, 1-1/8"-1-3/8" length, 3978 Cloverleaf or equivalent tailpiece required.	\$2,942.45
Motor Driven Electric Latch Retraction	MLR	Provides the means of locking or unlocking exit devices remotely using an electric motor. Recommend Hager 2903 or 2904 Power Supply.	\$1,123.00
Motor Driven Electric Latch Retraction with Request to Exit	MLRX	Provides the means of locking or unlocking exit devices remotely using an electric motor, along with an SPDT switch. Recommend Hager 2903 or 2904 Power Supply.	\$1,271.45
Motor Driven Electric Latch Retraction with Request to Exit and Latchbolt Monitoring	MLRXLM	Provides the means of locking or unlocking exit devices remotely using an electric motor, along with two internal SPDT switches that monitor the pushbar and latchbolt simultaneously. Recommend Hager 2903 or 2904 Power Supply.	\$1,524.85
Motor Driven Electric Latch Retraction with Latchbolt Monitoring	MLRLM	Provides the means of locking or unlocking exit devices remotely using an electric motor along with an internal SPDT switch that monitors the latchbolt. Recommend Hager 2903 or 2904 Power Supply.	\$1,380.70
Electrified Mortise Exit Device	EU/EL	Provides the means of locking or unlocking outside lever trim controls remotely Specify Fail Safe (EL) or Fail Secure (EU) and voltage (12V or 24V).	\$551.40

*Available on 4500 Series only.



POWER SUPPLIES

PRODUCT #	DESCRIPTION	LIST PRICE
2903	Provides 24 Volt DC power for Fail Safe or Fail Secure locking devices and interface with building alarm controls, card readers, keypads, and other door controls	Reference Electrified Products for Pricing
2904	Provides 24 Volt DC power and control for openings with an electrified locking device and automatic door operator	Reference Electrified Products for Pricing
2908	Provides up to 1 amp of 12 or 24 Volt DC power.	Reference Electrified Products for Pricing
2909	Provides up to 2 amps of 12 or 24 Volt DC power.	Reference Electrified Products for Pricing

QUICK CONNECT

Available for use with 4500 and 4600 Series Electrifications ED, LM, MLR, RX and AI (4500 only). Compatible with Hager Quick Connect Harness Cables which can plug into Hager hinges with quick connect for quick and accurate wiring of the door. No additional charge.

ALARMED DEVICES

4501/4601 ALK - Alarm Kit

Add \$347.25 to the list price of the device

4501/4601 ALM - ALK with Latch Monitor Switch (recommended for use with SVR devices)

Add \$466.25 to the list price of the device

4501/4601 ALT - ALK with Tamper Switch

Add \$466.25 to the list price of the device

4501/4601 ALL - ALK with Latch Monitor and Tamper Switch

Add \$585.25 to the list price of the device

Note: Alarm kit components may be purchased separately.



Exit Devices

4500 SERIES EXIT DEVICE

4501

RIM

FR 36"

US3

1-3/4"

ALK

Type

- RIM - Rim Device
- SVR - Surface Vertical Rod
- LBR - Surface Vertical Rod
Less Bottom Rod¹
- CVR - Concealed Vertical Rod
- CLB - Concealed Vertical Rod
Less Bottom Rod¹
- DMY - Dummy Push Pad
- MRT - Mortise Device (MC, MB, MD)
- MRTN - Mortise Night Latch Device (MN)

Product Group

4500 Series, Grade 1

Rating

- FR - Fire-Rated
- O - Non-Fire Rated
- CD - Cylinder Dogging
- CDW - Cylinder Dogging and Windstorm Rated
- LD - Less Dogging
- WR - Windstorm Rated
- FW - Windstorm and Fire-Rated

Door Size²

- 36"
- 48"
- 36" x 84"
- 36" x 96"
- 48" x 84"
- 48" x 96"

Finish

- US3
- US4
- US10
- US10B
- US26
- US26D
- US32D
- BLK⁷

Door Thickness

- 1-5/8"
- 1-3/4"
- 2"
- 2-1/2"
- 3"

Electric Modifications

- AI - Authorized Ingress³
- ALK - Alarm Kit
- ALL - Alarm Kit w/ Tamper Switch and Latch Monitor
- ALM - Alarm Kit w/ Latch Monitor
- ALT - Alarm Kit w/ Tamper Switch
- DE - Delayed Egress
- OBDE - Onboarded Delayed Egress
- ED - Electric Dogging
- EDRX - Electric Dogging w/ Request to Exit
- LM - Latchbolt Monitor³
- RX - Request to Exit
- RX2 - Dual Request to Exit
- RXAI - Request to Exit w/ Authorized Ingress³
- RXLM - Request to Exit w/ Latchbolt Monitor³
- MLR - Motor Driven Electric Latch Retraction
- MLRX - Motor Driven Electric Latch Retraction w/ Request to Exit
- MLRLM - Motor Driven Electric Latch Retraction w/Latchbolt Monitoring³
- MLRXL - Motor Driven Electric Latch Retraction w/Request to Exit & Latchbolt Monitoring³
- EL12 - Fail Safe, 12 Volt⁶
- EL24 - Fail Safe, 24 Volt⁶
- EU12 - Fail Secure, 12 Volt⁶
- EU24 - Fail Secure, 24 Volt⁶

4500 SERIES TRIM

45

CE

ARC

US3

1-3/4"

TW

Product Group

45 - 4500 Series, Grade 1

Trim/Function

- BE - Blank Escutcheon
Function 14, always operable
- CE - Cylinder Escutcheon
Function 08, key locks/unlocks
- DT - Dummy Trim
Function 02, pull when dogged down
- ET - Electric Escutcheon Trim (E05/E06)
- NL - Night Latch (1-3/4" to 2-1/2" doors)
Function 03, key retracts latchbolt
- PD - Pull Plate Dummy Trim (Not available for CVR device)
Function 02, pull when dogged down
- PN - Pull Plate Night Latch (Not available for CVR device)
Function 03, key retracts latchbolt
- PT - Thumbpiece Entrance (Not available for CVR device)
Function 05, key locks or unlocks thumbpiece
- MB - Mortise Blank Escutcheon⁴
Function 14, always operable
- MC - Mortise Cylinder Escutcheon⁴
Function 08, key locks/unlocks
- MD - Mortise Dummy Trim⁴
Function 02, pull when dogged down
- MN - Mortise Night Latch⁴
Function 03, key retracts latchbolt

Lever Style

- ARC - Archer
- AUG - August
- WLM - William
- WTN - Withnell
- CHA - Charles
- JHN - Johnston⁵
- JOS - Joshua
- LOU - Louis
- WRN - Warren⁵

Finish

- US3
- US4
- US10
- US10B
- US26
- US26D
- US32D (pull plate trim only)
- BLK⁷

Door Thickness

- 1-5/8"
- 1-3/4"
- 2"
- 2-1/2"
- 3"

Options

- TW - Tactile Warning
- A- Antimicrobial Coating
(US26D and US32D only)

¹Fire-rated LBR and CLB devices must be ordered in pairs of vertical rod devices or can be used in conjunction with an approved automatic or constant latching flush bolt. When ordering pairs, specify one device LBR and second device LBR with fire bolt, for example: 4501 LBR Fire 36" x 84" plus 4501 LBR Fire 36" x 84" EO with bolt OR 4501 LBR Fire 36" x 84" plus an approved automatic constant latching flush bolt.

²24" door size available with extended lead times.

³Not available on Mortise Exit Devices.

⁴Mortise trim does not match centerline of other 4500 Series trim. Cannot be used with 4500 Series Rim or Vertical Rod devices.

⁵Johnston and Warren lever designs are handed. Specify LHR/RH or RHR/LH when ordering.

⁶Only applicable to 4501 MRTN devices.

⁷Extended lead time for flat black finish.

Notes:

- a. Mortise cylinder 3902 is required for use with cylinder escutcheon trim and pull plate with thumbpiece trim and is sold separately.
- b. Rim cylinder with long tailpiece 3901 is required for use with night latch trim and is sold separately.
- c. For more cylinder information, please refer to Cylinder, Core & Keying in the Locks section of the catalog.
- d. If using shim kit, specify total door thickness including shims.
- e. ET Trim works with both 12V or 24V and is field-selectable between Fail Safe (EL) or Fail Secure (EU).



4600 SERIES EXIT DEVICE

4601

Product Group

4600 Series, Grade 1

RIM

Type

RIM - Rim Device
 CVR - Concealed Vertical Rod Device
 CLB - Concealed Vertical Rod
 Less Bottom Rod

FR

Rating

FR - Fire Rated⁶
 O - Non-Fire Rated
 CD - Cylinder Dogging
 LD - Less Dogging

36"

Size

36"
 48"

US3

Finish

US3
 US4
 US10
 US10B
 US26
 US26D
 US32D
 BLK¹

Door Thickness

1-5/8"
 1-3/4"
 2"
 2-1/2"
 3"

1-3/4"

MLR

Electric Modifications

ALK - Alarm Kit⁶
 ALL - Alarm Kit w/ Tamper Switch and Latch Monitor⁶
 ALM - Alarm Kit w/ Latch Monitor⁶
 ALT - Alarm Kit w/ Tamper Switch⁶
 DE - Delayed Egress
 ED - Electric Dogging
 EDRX - Electric Dogging w/ Request to Exit
 LM - Latchbolt Monitor
 RX - Request to Exit
 RX2 - Dual Request to Exit
 RXLM - Request to Exit w/ Latchbolt Monitor
 MLR - Motor Driven Electric Latch Retraction
 MLRX - Motor Driven Electric Latch Retraction w/ Request to Exit
 MLRLM - Motor Driven Latch Retraction with Latchbolt Monitoring
 MLRXLM - Motor Driven Electric Latch Retraction with Request to Exit and Latchbolt Monitoring

4600 SERIES TRIM

46

Product Group

46 - 4600 Series, Grade 1

CE

Trim/Function

BE - Blank Escutcheon
 Function 14, always operable
 CE - Cylinder Escutcheon²
 Function 08, key locks/unlocks lever
 DT - Dummy Trim
 Function 02, pull when dogged down
 NL - Night Latch³(Not available for 3" door)
 Function 03, key retracts latchbolt

ARC

Lever Style

ARC - Archer
 AUG - August
 WLM - William
 WTN - Withnell

US3

Finish

US3
 US4
 US10
 US10B
 US26
 US26D
 BLK¹

1-3/4"

Door Thickness

1-5/8"
 1-3/4"
 2"
 2-1/2"
 3"

TW

Options

TW - Tactile Warning
 A - Antimicrobial Coating (US26D only)

Notes:

1. Extended lead time on flat black finish.
2. Mortise cylinder 3902 with 3976 L cam is required for use with cylinder escutcheon trim is sold separately.
3. Rim cylinder 3901 with long tailpiece is required for use with night latch trim and is sold separately.
4. For more cylinder information, please refer to Cylinder, Core & Keying in the Locks section of the catalog.
5. If using shim kit, specify total door thickness including shims.
6. Not available on 4600 CVR or CLB.



Exit Devices

4700 SERIES EXIT DEVICE

4701	RIM	FR	36"	US3	2"
Product Group	Type	Rating	Size	Finish	Door Thickness
4700 Series, Standard Duty	RIM - Rim Device SVR - Surface Vertical Rod	FR - Fire Rated 0 - Non-Fire Rated	36" 48" 36" x 84" 36" x 96" 48" x 84" 48" x 96"	US3 US32D ALM DBZ	1-5/8" 1-3/4" 2" 2-1/4"

4700 SERIES TRIM

47	CE	RH	ARC	US3	2"	TW
Product Group	Trim/Function	Handing	Lever Style	Finish	Door Thickness	Options
47 - 4700 Series, Standard Duty	CE - Cylinder Escutcheon Function 08, key locks/unlocks BE - Blank Escutcheon Function 14, always operable NL - Night Latch Function 03, key retracts latchbolt DT - Dummy Trim Function 02, pull when dogged down KD- Key in Lever - Dummy Trim Function 02, entrance by trim when actuating bar is locked down KE- Key in Lever - Entrance Function 08, entrance by trim (key locks or unlocks trim) KN- Key in Lever - Night Latch Function 03, entrance by trim when latch bolt is released by key; removable when locked KP- Key in Lever - Passage Function 14, entrance by trim when latch bolt is released by lever; always active; no cylinder PD- Pull Plate Dummy Trim Function 02, pull when dogged down PN- Pull Plate Night Latch Function 03, key retracts latchbolt RD- Raised Lip Pull - Dummy Trim Function 02, pull when dogged down RN- Raised Lip Pull - Night Latch Function 03, key retracts latches BT- Thumbpiece Pull Plate, Passage Function 15, entrance by trim when latch is released by thumbpiece. Thumbpiece is always active, no cylinder PT- Thumbpiece Pull Plate, Entrance Function 05, entrance by thumbpiece. Key locks or unlocks thumb piece	RH - Right Handed / LHR LH - Left Handed / RHR	ARC - Archer AUG - August WTN - Withnell APL - Apollo knob	US3 US32D ALM DBZ	1-5/8" 1-3/4" 2" 2-1/4"	TW - Tactile Warning A - Antimicrobial Coating

Notes:

1. Handing is required for the 4700 Series trim.
2. Cylinders sold separately.
3. For more cylinder information, please refer to Cylinder, Core & Keying in the Locks section of the catalog.
4. Maximum door thickness compatibility for key-in-lever (Entrance, Night Latch, and Passage) trim is 1-3/4" (44 mm)





Description	Length	Finish	2021 List	Stock No.	List Fire Rated	Stock No.	Case Qty.
4501 RIM	36"	US3	1,026.30	158092	1,172.10	158111	3
4501 RIM	Exit Only	US4	1,026.30	158094	1,172.10	158107	
Grade 1		US10	1,026.30	158087	1,172.10	115725	
Non-Handed		US10B	1,026.30	158088	1,172.10	158103	
		US26	1,026.30	158089	1,172.10	158109	
Cylinder Dogging (specify CD), add \$43.10 to list price. 3902 mortise cylinder with standard cam must be ordered separately.		US26D	990.85	158090	1,172.10	158104	
		US32D	1,026.30	158093	1,172.10	158105	
	48"	US3	1,062.95	156140	1,217.40	156145	3
Exit Only		US4	1,062.95	156141	1,217.40	156146	
		US10	1,062.95	156138	1,217.40	156142	
Severe Windstorm Rated device, add \$53.90 to list price and specify WR.		US10B	1,062.95	156139	1,217.40	156143	
		US26	1,062.95	158180	1,217.40	156144	
Refer to page 4 for electric modification pricing.		US26D	1,037.25	156135	1,179.15	154983	
		US32D	1,062.95	156136	1,217.40	156137	

Anti-microbial coating - add \$46.65 to list price.



4501 SVR LBR	36" x 84"	US3	1,512.15	129450	1,638.85	126690	3
Grade 1	Exit Only	US4	1,512.15	131538	1,638.85	135130	
Non-Handed		US10	1,512.15	130713	1,638.85	144325	
		US10B	1,512.15	127645	1,638.85	126438	
Cylinder Dogging (specify CD), add \$43.10 to list price. 3902 mortise cylinder with standard cam must be ordered separately.		US26	1,512.15	-	1,638.85	146277	
		US26D	1,396.45	124387	1,532.40	124389	
		US32D	1,512.15	174486	1,638.85	170442	
	36" x 96"	US3	1,568.40	-	1,712.55	-	3
Exit Only		US4	1,568.40	152521	1,712.55	173396	
		US10	1,568.40	-	1,712.55	153887	
		US10B	1,568.40	143515	1,712.55	126441	
Fire rated LBR devices must be ordered in pairs of less bottom rod vertical rod devices and with a spring loaded fire latch (Part # 2-649-0166 - add \$50.35 to list price) to ensure the device's fire rating.		US26	1,568.40	-	1,712.55	032342	
		US26D	1,486.50	127422	1,620.85	133810	
		US32D	1,568.40	133952	1,712.55	124391	
	48" x 84"	US3	1,620.85	-	1,758.40	146813	3
Exit Only		US4	1,620.85	131540	1,758.40	147614	
		US10	1,620.85	148071	1,758.40	-	
Refer to page 25 for extension rod kits for doors over 8 feet in height. Note that these are not fire rated for the LBR.		US10B	1,620.85	161824	1,758.40	127646	
		US26	1,620.85	-	1,758.40	-	
		US26D	1,532.40	129506	1,656.85	127252	
		US32D	1,620.85	138585	1,758.40	156237	
	48" x 96"	US3	1,649.75	-	1,785.10	-	3
Exit Only		US4	1,649.75	-	1,785.10	-	
		US10	1,649.75	-	1,785.10	-	
		US10B	1,649.75	173468	1,785.10	137024	
		US26	1,649.75	-	1,785.10	-	
		US26D	1,620.85	147312	1,712.55	129948	
		US32D	1,649.75	149138	1,785.10	138708	

1. Items with the price in **bold and red** are Quick Ship items and ship in 24 hours. Please use stock number when ordering. 2. U/M is each unless otherwise noted.



Exit Devices - 4500



Description	Length	Finish	2021 List	Stock No.	List Fire Rated	Stock No.	Case Qty.	
4501 SVR Grade 1 Non-Handed Cylinder Dogging (specify CD), add \$43.10 to list price. 3902 mortise cylinder with standard cam must be ordered separately.	36" x 84"	US3	1,512.15	157344	1,638.85	157393	3	
	Exit Only	US4	1,512.15	157346	1,638.85	157395		
		US10	1,512.15	157398	1,638.85	169257		
	Severe Windstorm Rated device, add \$53.90 to list price and specify WR.	Exit Only	US10B	1,512.15	157341	1,638.85	157422	
			US26	1,512.15	157342	1,638.85	158058	
			US26D	1,396.45	157343	1,532.40	157392	
			US32D	1,512.15	157345	1,638.85	157394	
	Refer to page 4 for electric modification.	Exit Only	US3	1,568.40	157400	1,712.55	157426	3
			US4	1,568.40	157401	1,712.55	158068	
			US10	1,568.40	157548	1,712.55	158064	
US10B			1,568.40	157399	1,715.55	157424		
US26			1,568.40	157568	1,712.55	157425		
US26D			1,486.50	157390	1,620.85	157396		
Refer to page 25 for extension rod kits for doors over 8 feet in height.	Exit Only	US32D	1,568.40	157391	1,712.85	157397		
		US3			1,797.15	-	3	
		US4			1,797.15	157421		
		US10			1,797.15	-		
		US10B			1,797.15	157887		
		US26			1,797.15	-		
Anti-microbial coating - add \$46.65 to list price.	Exit Only	US26D			1,673.15	157418		
		US32D			1,797.15	157420		
		US3	1,620.85	157895	1,758.40	156229	3	
		US4	1,620.85	156152	1,758.40	158074		
		US10	1,620.85	157734	1,758.40	158070		
		US10B	1,620.85	156149	1,758.40	154982		
	Exit Only	US26	1,620.85	156150	1,758.40	156227		
		US26D	1,532.40	156147	1,758.40	156148		
		US32D	1,620.85	156151	1,758.40	156230		
		US3	1,649.75	157901	1,785.10	158076	3	
		US4	1,649.75	157906	1,785.10	156235		
		US10	1,649.75	157899	1,785.10	-		
	Exit Only	US10B	1,649.75	157900	1,785.10	156231		
		US26	1,649.75	156153	1,785.10	156232		
		US26D	1,620.85	156154	1,712.55	156233		
		US32D	1,649.75	157905	1,785.10	156234		
		US3			1,873.05	-	3	
		US4			1,873.05	-		
	Exit Only	US10			1,873.05	-		
		US10B			1,873.05	156156		
		US26			1,873.05	-		
		US26D			1,743.65	158069		
		US32D			1,873.05	156225		





Description	Length	Finish	2021 List	Stock No.	List Fire Rated	Stock No.	Case Qty.	
4501 CVR	36" x 84"	US3	1,900.90	033019	2,130.15	-	3	
Grade 1	Exit Only	US4	1,900.90	-	2,130.15	-		
Non-Handed		US10	1,900.90	042432	2,130.15	-		
Cylinder Dogging (specify CD), add \$43.10 to list price. 3902 mortise cylinder with standard cam must be ordered separately.		US10B	1,900.90	050046	2,130.15	050040		
		US26	1,900.90	-	2,130.15	044155		
		US26D	1,900.90	050065	2,130.15	050059		
		US32D	1,900.90	50051	2,130.15	149313		
Refer to page 4 for electric modification pricing.	36" x 96"	US3	1,941.25	-	2,170.55	-	3	
	Exit Only	US4	1,941.25	-	2,170.55	-		
		US10	1,941.25	-	2,170.55	-		
		US10B	1,941.25	050030	2,170.55	050036		
		US26	1,941.25	-	2,170.55	-		
Refer to page 25 for extension rod kits for doors over 8 feet in height.		US26D	1,941.25	150761	2,170.55	050065		
		US32D	1,941.25	150762	2,170.55	050066		
	Anti-microbial coating - add \$46.65 to list price.	48" x 84"	US3	1,978.40	-	2,207.65	-	3
		Exit Only	US4	1,978.40	-	2,207.65	-	
		US10	1,978.40	-	2,207.65	-		
		US10B	1,978.40	048224	2,207.65	-		
		US26	1,978.40	050063	2,207.65	-		
	US26D	1,978.40	050043	2,207.65	036355			
	US32D	1,978.40	-	2,207.65	050037			
48" x 96"	US3	2,018.75	168182	2,248.05	-	3		
	Exit Only	US4	2,018.75	168184	2,248.05	-		
		US10	2,018.75	168180	2,248.05	-		
		US10B	2,018.75	168172	2,248.05	-		
		US26	2,018.75	168181	2,248.05	-		
		US26D	2,018.75	168167	2,248.05	036465		
	US32D	2,018.75	168183	2,248.05	047054			

1. Items with the price in **bold and red** are Quick Ship items and ship in 24 hours. Please use stock number when ordering. 2. U/M is each unless otherwise noted.



Exit Devices - 4500



Description	Length	Finish	2021 List	Stock No.	List Fire Rated	Stock No.	Case Qty.	
4501 CLB Grade 1 Non-Handed Cylinder Dogging (specify CD), add \$43.10 to list price. 3902 mortise cylinder with standard cam must be ordered separately.	36" x 84"	US3	1,900.90	-	2,130.15	-	3	
	Exit Only	US4	1,900.90	-	2,130.15	-		
		US10	1,900.90	-	2,130.15	-		
	Fire rated LBR devices must be ordered in pairs of less bottom rod vertical rod devices and with a spring loaded fire bolt (Part # 2-649-0166, add \$50.35 to list price) to ensure the device's fire rating.	Exit Only	US10B	1,900.90	-	2,130.15	-	
			US26	1,900.90	-	2,130.15	-	
			US26D	1,900.90	047320	2,130.15	049802	
			US32D	1,900.90	049969	2,130.15	045528	
	Refer to page 4 for electric modification pricing.	Exit Only	US3	1,941.25	-	2,170.55	-	3
			US4	1,941.25	-	2,170.55	-	
			US10	1,941.25	-	2,170.55	-	
US10B			1,941.25	-	2,170.55	034331		
US26			1,941.25	-	2,170.55	-		
US26D			1,941.25	037393	2,170.55	045040		
Refer to page 25 for extension rod kits for doors over 8 feet in height	Exit Only	US32D	1,941.25	046227	2,170.55	036300		
		US3	1,978.40	-	2,207.65	-	3	
		US4	1,978.40	-	2,207.65	-		
Anti-microbial coating - add \$46.65 to list price.	Exit Only	US10	1,978.40	-	2,207.65	-		
		US10B	1,978.40	-	2,207.65	-		
		US26	1,978.40	-	2,207.65	-		
		US26D	1,978.40	-	2,207.65	044976		
		US32D	1,978.40	-	2,207.65	161879		
Anti-microbial coating - add \$46.65 to list price.	Exit Only	US3	2,018.75	-	2,248.05	-	3	
		US4	2,018.75	-	2,248.05	-		
		US10	2,018.75	-	2,248.05	-		
		US10B	2,018.75	-	2,248.05	-		
		US26	2,018.75	-	2,248.05	-		
		US26D	2,018.75	-	2,248.05	-		
		US32D	2,018.75	049967	2,248.05	-		

Mortise Lock Exit Devices

Grade 1
Non-Handed

Cylinder Dogging (specify CD), add \$43.10 to list price. 3902 mortise cylinder with standard cam must be ordered separately.

Refer to page 4 for electric modification pricing.
Anti-microbial coating - add \$46.65 to list price.



4501 M (Pair with MB, MC, MD trim)	Exit Only	36"	US3	1,907.45	084209	2,096.85	-	3
		Exit Only	US4	1,907.45	084199	2,096.85	084081	
			US10	1,907.45	084277	2,096.85	084126	
			US10B	1,907.45	084276	2,096.85	084123	
			US26	1,907.45	084268	2,096.85	084120	
			US26D	1,841.45	084249	2,025.90	084116	
			US32D	1,907.45	084203	2,096.85	084104	
Exit Only	48"	US3	1,932.50	045758	2,122.00	084074	3	
	Exit Only	US4	1,932.50	-	2,122.00	-		
		US10	1,932.50	-	2,122.00	-		
		US10B	1,932.50	-	2,122.00	-		
		US26	1,932.50	-	2,122.00	084078		
		US26D	1,866.50	084190	2,048.80	162835		
		US32D	1,932.50	084146	2,122.00	162837		



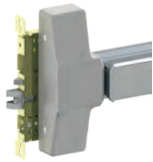

Description	Length	Finish	2021 List	Stock No.	List Fire Rated	Stock No.	Case Qty.
4501 N (Pair with MN trim)	36" Exit Only	US3	1,907.45	-	2,096.85	-	3
		US4	1,907.45	-	2,096.85	-	
		US10	1,907.45	-	2,096.85	-	
		US10B	1,907.45	084027	2,096.85	083976	
		US26	1,907.45	-	2,096.85	-	
		US26D	1,841.35	084005	2,025.90	083971	
		US32D	1,907.45	083998	2,096.85	083930	
48" Exit Only		US3	1,932.50	-	2,122.00	-	3
		US4	1,932.50	-	2,122.00	-	
		US10	1,932.50	-	2,122.00	-	
		US10B	1,932.50	-	2,122.00	-	
		US26	1,932.50	-	2,122.00	-	
		US26D	1,866.50	083982	2,048.80	083904	
		US32D	1,932.50	083979	2,122.00	083896	



4501 D Dummy Push Pad Non-handed For use with 4500 and 4600 Series Exit Devices	36"	US3	646.90	149393			3
		US10B	646.90	149392			
		US26D	567.75	149391			
		US32D	646.90	149390			
48" Anti-microbial coating - add \$46.65 to list price.		US3	672.05	-			3
		US10B	672.05	149396			
		US26D	592.90	149395			
		US32D	672.05	149394			



Description	Function	Finish	2021 List	Stock No. LHR	2021 List	Stock No. RHR	Case Qty.
45BE Blank Escutcheon Tactile Warning - add \$42.40 to list price. Anti-microbial coating - add \$46.65 to list price.							
Archer Lever	14 Always Operable	US3	524.10	122812			6
		US4	524.10	122814			
		US10	524.10	122804			
		US10B	524.10	122806			
		US26	524.10	122808			
		US26D	504.45	122810			
August Lever		US3	524.10	122796			6
		US4	524.10	122797			
		US10	524.10	122792			
		US10B	524.10	122793			
		US26	524.10	122794			
		US26D	504.45	122795			
Charles Lever		US3	524.10	-			6
		US4	524.10	-			
		US10	524.10	-			
		US10B	524.10	178079			
		US26	524.10	-			
		US26D	504.45	176196			
Johnston Lever (must specify handling)		US3	524.10	-	524.10	-	6
		US4	524.10	178146	524.10	-	
		US10	524.10	178136	524.10	178142	
		US10B	524.10	177946	524.10	177951	
		US26	524.10	178130	524.10	178133	
		US26D	504.45	177384	504.45	177387	

1. Items with the price in **bold and red** are Quick Ship items and ship in 24 hours.
Please use stock number when ordering. 2. U/M is each unless otherwise noted.



Exit Devices - 4500

Description	Function	Finish	2021 List	Stock No. LHR	2021 List	Stock No. RHR	Case Qty.
Joshua Lever	14	US3	524.10	-			6
	Always	US4	524.10	-			
	Operable	US10	524.10	-			
		US10B	524.10	178087			
		US26	524.10	-			
		US26D	504.45	178084			
Louis Lever		US3	524.10	177349			6
		US4	524.10	177356			
		US10	524.10	177291			
		US10B	524.10	177296			
		US26	524.10	177301			
		US26D	504.45	177305			
Warren Lever (must specify handling)		US3	524.10	-	524.10	-	6
		US4	524.10	-	524.10	-	
		US10	524.10	-	524.10	-	
		US10B	524.10	178053	524.10	178057	
		US26	524.10	-	524.10	-	
		US26D	504.45	178031	504.45	178048	
William Lever		US3	524.10	-			6
		US4	524.10	-			
		US10	524.10	165841			
		US10B	524.10	165842			
		US26	524.10	165843			
		US26D	504.45	165844			
Withnell Lever		US3	524.10	122813			6
		US4	524.10	122815			
		US10	524.10	122805			
		US10B	524.10	122807			
		US26	524.10	122809			
		US26D	504.45	122811			

45MB

Blank Escutcheon for use with 4501M Mortise Lock Exit Device
Mortise trim does not match centerline of other 4500 Series trim
Tactile Warning - add \$42.40 to list price.
Anti-microbial coating - add \$46.65 to list price.



Archer Lever	14 Always	US3	524.10	-			6
		US4	524.10	-			
	Operable	US10	524.10	-			
		US10B	524.10	163696			
		US26	524.10	163699			
		US26D	504.45	163559			
August Lever		US3	524.10	-			6
		US4	524.10	-			
		US10	524.10	-			
		US10B	524.10	163697			
		US26	524.10	163700			
		US26D	504.45	163560			



Description	Function	Finish	2021 List	Stock No.	Case Qty.
William Lever		US3	524.10	-	6
		US4	524.10	-	
		US10	524.10	-	
		US10B	524.10	-	
		US26	524.10	-	
		US26D	504.45	163624	
Withnell Lever		US3	524.10	-	6
		US4	524.10	163599	
		US10	524.10	-	
		US10B	524.10	163558	
		US26	524.10	163702	
		US26D	504.45	163561	



Description	Function	Finish	2021 List	Stock No. LHR	2021 List	Stock No. RHR	Case Qty.
45CE							
Cylinder Escutcheon							
Requires a 3902 mortise cylinder (with standard cam) sold separately							
Tactile Warning - add \$42.40 to list price.							
Anti-microbial coating - add \$46.65 to list price.							
Refer to page 4 for electric modification pricing.							
Archer Lever	08 Key locks or unlocks lever	US3	524.10	122824			6
		US4	524.10	122826			
		US10	524.10	122816			
		US10B	524.10	122818			
		US26	524.10	122820			
		US26D	504.45	122822			
August Lever		US3	524.10	122802			6
		US4	524.10	122803			
		US10	524.10	122798			
		US10B	524.10	122799			
		US26	524.10	122800			
		US26D	504.45	122801			
Charles Lever		US3	524.10	-			6
		US4	524.10	-			
		US10	524.10	-			
		US10B	524.10	178080			
		US26	524.10	-			
		US26D	504.45	176193			
Johnston Lever (must specify handling)		US3	524.10	-	524.10	-	6
		US4	524.10	178147	524.10	-	
		US10	524.10	178137	524.10	178143	
		US10B	524.10	177948	524.10	177952	
		US26	524.10	178131	524.10	178134	
		US26D	504.45	177385	504.45	177386	

1. Items with the price in **bold and red** are Quick Ship items and ship in 24 hours.
Please use stock number when ordering. 2. U/M is each unless otherwise noted.



Exit Devices - 4500

Description	Function	Finish	2021 List	Stock No. LHR	2021 List	Stock No. RHR	Case Qty.
Joshua Lever	08	US3	524.10	-			6
	Key locks or unlocks lever	US4	524.10	-			
		US10	524.10	-			
		US10B	524.10	178088			
		US26	524.10	-			
		US26D	504.45	178085			
Louis Lever	US3	524.10	177350			6	
	US4	524.10	177357				
	US10	524.10	177292				
	US10B	524.10	177298				
	US26	524.10	177302				
	US26D	504.45	177306				
Warren Lever (must specify handling)	US3	524.10	-	524.10	-	6	
	US4	524.10	-	524.10	-		
	US10	524.10	-	524.10	-		
	US10B	524.10	178054	524.10	178058		
	US26	524.10	-	524.10	-		
	US26D	504.45	178032	504.45	178049		
William Lever	US3	524.10	159126			6	
	US4	524.10	159127				
	US10	524.10	159128				
	US10B	524.10	159121				
	US26	524.10	159129				
	US26D	504.45	159109				
Withnell Lever	US3	524.10	122825			6	
	US4	524.10	122827				
	US10	524.10	122817				
	US10B	524.10	122819				
	US26	524.10	122821				
	US26D	504.45	122823				

45MC

Cylinder Escutcheon for use with 4501M Mortise Lock Exit Device
Mortise trim does not match centerline of other 4500 Series trim
Requires a 3902 mortise cylinder (1-5/8" with standard cam) sold separately.
Tactile Warning - add \$42.40 to list price.
Anti-microbial coating - add \$46.65 to list price.



Archer Lever	08	US3	524.10	-		6
	Key locks or unlocks lever	US4	524.10	163708		
		US10	524.10	163711		
		US10B	524.10	163562		
		US26	524.10	163717		
		US26D	504.45	163523		
August Lever	US3	524.10	-			6
	US4	524.10	163709			
	US10	524.10	-			
	US10B	524.10	163715			
	US26	524.10	163718			
	US26D	504.45	163564			



Description	Function	Finish	2021 List	Stock No.	Case Qty.
William Lever		US3	524.10	-	6
		US4	524.10	163625	
		US10	524.10	-	
		US10B	524.10	163716	
		US26	524.10	-	
		US26D	504.45	163626	
Withnell Lever		US3	524.10	163707	6
		US4	524.10	163710	
		US10	524.10	163714	
		US10B	524.10	163563	
		US26	524.10	163720	
		US26D	504.45	163565	



Description	Function	Finish	2021 List	Stock No. LHR	2021 List	Stock No. RHR	Case Qty.
45DT Dummy Trim Tactile Warning - add \$42.40 to list price. Anti-microbial coating - add \$46.65 to list price.							
Archer Lever	02	US3	524.10	14036			6
	Pull when device is dogged down	US4	524.10	14023			
		US10	524.10	14049			
		US10B	524.10	14038			
		US26	524.10	60033			
		US26D	504.45	60018			
August Lever		US3	524.10	107837			6
		US4	524.10	107838			
		US10	524.10	107833			
		US10B	524.10	107834			
		US26	524.10	107835			
		US26D	504.45	107836			
Charles Lever		US3	524.10	-			6
		US4	524.10	-			
		US10	524.10	-			
		US10B	524.10	178082			
		US26	524.10	-			
		US26D	504.45	178078			
Johnston Lever (must specify handling)		US3	524.10	-	524.10	-	6
		US4	524.10	178148	524.10	-	
		US10	524.10	178138	524.10	178144	
		US10B	524.10	177949	524.10	177953	
		US26	524.10	178132	524.10	178135	
		US26D	504.45	177937	504.45	177940	
Joshua Lever		US3	524.10	-			6
		US4	524.10	-			
		US10	524.10	-			
		US10B	524.10	178089			
		US26	524.10	-			
		US26D	504.45	178086			

1. Items with the price in **bold and red** are Quick Ship items and ship in 24 hours.
Please use stock number when ordering. 2. U/M is each unless otherwise noted.



Exit Devices - 4500

Description	Function	Finish	2021 List	Stock No. LHR	2021 List	Stock No. RHR	Case Qty.
Louis Lever	02	US3	524.10	177354			6
	Pull when device is dogged down	US4	524.10	177358			
		US10	524.10	177295			
		US10B	524.10	177299			
		US26	524.10	177303			
		US26D	504.45	177307			
Warren Lever (must specify handling)	US3	524.10	-	524.10	-	6	
	US4	524.10	-	524.10	-		
	US10	524.10	-	524.10	-		
	US10B	524.10	178055	524.10	178059		
	US26	524.10	-	524.10	-		
	US26D	504.45	178046	504.45	178050		
William Lever	US3	524.10	-			6	
	US4	524.10	-				
	US10	524.10	-				
	US10B	524.10	165848				
	US26	524.10	-				
	US26D	504.45	165850				
Withnell Lever	US3	524.10	14035			6	
	US4	524.10	14020				
	US10	524.10	14045				
	US10B	524.10	14037				
	US26	524.10	60027				
	US26D	504.45	60017				

Description	Function	Finish	2021 List	Stock No.	Case Qty.
45MD					
Dummy Trim for use with 4501M Mortise Lock Exit Device					
Mortise trim does not match centerline of other 4500 Series trim					
Tactile Warning - add \$42.40 to list price.					
Anti-microbial coating - add \$46.65 to list price.					
Archer Lever	02	US3	524.10	-	6
	Pull when device is dogged down	US4	524.10	-	
		US10	524.10	-	
		US10B	524.10	-	
		US26	524.10	-	
		US26D	504.45	-	
August Lever	US3	524.10	-		6
	US4	524.10	-		
	US10	524.10	-		
	US10B	524.10	-		
	US26	524.10	-		
	US26D	504.45	-		



Description	Function	Finish	2021 List	Stock No.	Case Qty.
William Lever		US3	524.10	-	6
		US4	524.10	-	
		US10	524.10	-	
		US10B	524.10	-	
		US26	524.10	-	
		US26D	504.45	-	
Withnell Lever		US3	524.10	-	6
		US4	524.10	-	
		US10	524.10	-	
		US10B	524.10	-	
		US26	524.10	-	
		US26D	504.45	163727	

Description	Function	Finish	2021 List	Stock No.		Case Qty.	
				LHR	2021 List RHR		
45NL							
Night Latch							
Requires a 3901 rim cylinder (with long tailpiece) sold separately.							
Tactile Warning - add \$42.40 to list price.							
Anti-microbial coating - add \$46.65 to list price.							
Maximum door thickness compatibility is 2-1/2" (38 mm)							
Archer Lever	03	US3	524.10	14003		6	
	Key retracts latchbolt	US4	524.10	13984			
		US10	524.10	14015			
		US10B	524.10	14011			
		US26	524.10	60009			
		US26D	504.45	60000			
August Lever		US3	524.10	107844		6	
		US4	524.10	107845			
		US10	524.10	107840			
		US10B	524.10	107841			
		US26	524.10	107842			
		US26D	504.45	107843			
Charles Lever		US3	524.10	-		6	
		US4	524.10	-			
		US10	524.10	-			
		US10B	524.10	178083			
		US26	524.10	-			
		US26D	504.45	178429			
Johnston Lever (must specify handling)		US3	524.10	-	524.10	-	6
		US4	524.10	178149	524.10	-	
		US10	524.10	178139	524.10	178145	
		US10B	524.10	177950	524.10	177954	
		US26	524.10	177955	524.10	177956	
		US26D	504.45	177938	504.45	177941	



1. Items with the price in **bold and red** are Quick Ship items and ship in 24 hours.
Please use stock number when ordering. 2. U/M is each unless otherwise noted.



Exit Devices - 4500

Description	Function	Finish	2021 List	Stock No. LHR	Stock No. RHR	Case Qty.	
Joshua Lever	03 Key retracts latchbolt	US3	524.10	-		6	
		US4	524.10	-			
		US10	524.10	-			
		US10B	524.10	178092			
		US26	524.10	-			
		US26D	504.45	178091			
Louis Lever		US3	524.10	177355		6	
		US4	524.10	177359			
		US10	524.10	177294			
		US10B	524.10	177300			
		US26	524.10	177304			
		US26D	504.45	177308			
Warren Lever (must specify handling)		US3	524.10	-	524.10	-	6
		US4	524.10	-	524.10	-	
		US10	524.10	-	524.10	-	
		US10B	524.10	178056	524.10	178060	
		US26	524.10	-	524.10	-	
		US26D	504.45	178047	504.45	-	
William Lever		US3	524.10	-		6	
		US4	524.10	-			
		US10	524.10	-			
		US10B	524.10	159132			
		US26	524.10	159133			
		US26D	504.45	159112			
Withnell Lever		US3	524.10	13999		6	
		US4	524.10	13980			
		US10	524.10	14012			
		US10B	524.10	14007			
		US26	524.10	60008			
		US26D	504.45	60001			

Description	Function	Finish	2021 List	Stock No.	Case Qty.	
45MN						
Night Latch for use with 4501N Moritise Lock Exit Device						
Mortise trim does not match centerline of other 4500 Series trim						
Requires a 3902 mortise cylinder (1-5/8" with standard cam) sold separately.						
Tactile Warning - add \$42.40 to list price.						
Anti-microbial coating - add \$46.65 to list price.						
Archer Lever	03 Key retracts latchbolt	US3	524.10	-		6
		US4	524.10	-		
		US10	524.10	-		
		US10B	524.10	-		
		US26	524.10	-		
		US26D	504.45	163538		
August Lever		US3	524.10	-		6
		US4	524.10	-		
		US10	524.10	-		
		US10B	524.10	-		
		US26	524.10	-		
		US26D	504.45	163725		



Description	Function	Finish	2021 List	Stock No.	Case Qty.
William Lever		US3	524.10	-	6
		US4	524.10	-	
		US10	524.10	-	
		US10B	524.10	-	
		US26	524.10	-	
		US26D	504.45	169861	
Withnell Lever		US3	524.10	-	6
		US4	524.10	-	
		US10	524.10	-	
		US10B	524.10	-	
		US26	524.10	-	
		US26D	504.45	163726	
45PD Pull Plate - Dummy Trim For use with 4500 RIM, SVR, LBR, and CLB devices. Not for CVR. Tactile Warning - add \$42.40 to list price. Anti-microbial coating - add \$46.65 to list price.	02	US3	142.50	109038	12
	Pull when device is dogged down	US4	142.50	109039	
		US10	142.50	109040	
		US10B	142.50	109041	
		US26	142.50	109042	
		US26D	142.50	109043	
		US32D	142.50	109044	
45PN Pull Plate - Night Latch For use with 4500 RIM, SVR, LBR, and CLB devices. Not for CVR. Requires a 3901 rim cylinder (sold separately) Includes retaining cup for 161 door prep. Tactile Warning - add \$42.40 to list price. Anti-microbial coating - add \$46.65 to list price.	03	US3	159.45	109048	12
	Key retracts latchbolt	US4	159.45	109049	
		US10	159.45	109050	
		US10B	159.45	109051	
		US26	159.45	109052	
		US26D	159.45	109053	
		US32D	159.45	109054	
45PT Pull Plate - Thumbpiece For use with 4501 Rim device Requires a 3902 mortise cylinder (sold separately) Tactile Warning - add \$42.40 to list price. Anti-microbial coating - add \$46.65 to list price.	05	US32D	346.15	146142	6
	Key locks or unlocks thumb piece				
313SE Anti-Vandal Pull for 4500 Rim device Material: 11 GA stainless steel Max Projection: 1-7/8" Size: 6-11/32 x 11" Door Thickness: 1-3/4" - 2" Fasteners: 1/4" FPHMS with finish washers Rim cylinder 3901 sold separately Retaining cup 2-649-0137 for 161 prep sold separately	Dummy	US32D	316.60	185346	
	NL cyl. cutout LHR	US32D	316.60	185350	
	NL cyl. cutout RHR	US32D	316.60	185352	



1. Items with the price in **bold and red** are Quick Ship items and ship in 24 hours.
Please use stock number when ordering. 2. U/M is each unless otherwise noted.



Exit Devices - 4500



Description	Function	Finish	2021 List	Stock No.	Case Qty.
313LE Anti-Vandal Pull w/Latchguard for 4500 Rim Device Material: 11 GA stainless steel Max Projection: 1-7/8" Size: 6-11/32 x 11" Door Thickness: 1-3/4" - 2" Fasteners: 1/4" FPHMS with finish washers Rim cylinder 3901 sold separately Retaining cup 2-649-0137 for 161 prep sold separately	Dummy	US32D	358.90	185355	
	NL cyl. cutout LHR	US32D	358.90	185354	
	NL cyl. cutout RHR	US32D	358.90	185353	
4915 Threshold strike for use with 4500 or 4700 Series. Optional - order separately. Not for fire-rated doors.		US32D	25.70	67426	48
4920 Strike for use with 4500 Series or 4600 Series Rim Panic-Rated exit device. Included with 4500 RIM Panic-Rated device. Not for fire-rated doors.		US32D	72.10	16208	24
4920F Fire rated strike for use with 4500 Series or 4600 Series fire rated Rim exit device. Included with fire rated device.		US32D	99.95	16207	24
4921 Double door strike for 4500 Vertical Rod and Rim exit device. Optional - order separately. Not for fire-rated doors.		US3	72.10	102255	24
		US4	72.10	102256	
		US10	72.10	102257	
		US10B	72.10	102258	
		US26	72.10	102259	
		US32D	72.10	102271	



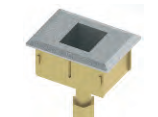

Description	Length	Finish	2021 List	Stock No.	Case Qty.
4923 Top strike for use with 4500 Series Surface Vertical Rod Panic-Rated device. Included with panic-rated device.		US32D	45.90	16206	24
4923F Fire rated top strike for use with 4500 Series Surface Vertical Rod device. Included with fire rated device.		US32D	56.25	16205	24
4924 Bottom strike for use with 4500 Series Vertical Rod devices. Included with panic rated device.		US32D	56.25	16203	12
4924F Fire rated bottom strike for use with 4500 Series Vertical Rod device. Included with fire rated device.		US32D	60.05	16201	12
4926 Cylinder Dogging Conversion Kit for panic rated 4500 device Requires a 3902 mortise cylinder (with standard cam) sold separately.	36"	US3	47.00	157135	48
		US4	47.00	157137	
		US10	47.00	157138	
		US10B	47.00	157139	
		US26	47.00	157140	
		US26D	47.00	157141	
		US32D	47.00	157142	
48"	US3	50.30	157143	36	
	US4	50.30	157144		
	US10	50.30	157145		
	US10B	50.30	157146		
	US26	50.30	157147		
	US26D	50.30	157148		
	US32D	50.30	157149		
4927 Bottom Latch Assembly for use with 4500 Series SVR Devices Includes latch, cover and screws. Included with device.		US3	99.95	2526	24
		US4	99.95	2525	
		US10	99.95	2524	
		US10B	99.95	2522	
		US26	99.95	2520	
		US26D	99.95	2518	
US32D	99.95	2511			

1. Items with the price in **bold and red** are Quick Ship items and ship in 24 hours. Please use stock number when ordering. 2. U/M is each unless otherwise noted.



Exit Devices - 4500

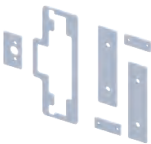
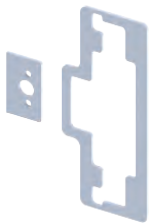

Description	Finish	2021 List	Stock No.	Case Qty.
4928 Top Latch Assembly for use with 4500 Series SVR and LBR Devices Includes latch, cover and screws. Included with device.	US3	99.95	112972	24
	US4	99.95	112974	
	US10	99.95	-	
	US10B	99.95	112969	
	US26	99.95	112970	
	US26D	99.95	112971	
	US32D	99.95	112973	
4929 SVR/LBR Rod Replacement Kit (top or bottom) Includes: One (1) each 45-1/4" (1149 mm) rod, rod connector, and appropriate fasteners.	US3	47.00	2634	24
	US4	47.00	2633	
	US10	47.00	2587	
	US10B	47.00	2582	
	US26	47.00	2573	
	US26D	47.00	2571	
	US32D	47.00	2564	
4929C CVR/CLB Rod Replacement Kit (top or bottom) Includes: One (1) each 46-5/8" (1184 mm) rod, rod connector, and appropriate fasteners.	US26D	47.00	165570	24
4930R Shim Kit for 4500 Rim Device Packaged 2 ea. 1/8" shims	US3	85.20	1440	24
	US4	85.20	1438	
	US10	85.20	1429	
	US10B	85.20	1428	
	US26	85.20	1426	
	US26D	85.20	1423	
	US32D	99.95	1421	
4930S Shim Kit for 4500 Surface Vertical Rod Device Packaged 2 ea. 1/8" shims	US3	85.20	1412	24
	US4	85.20	1411	
	US10	85.20	1406	
	US10B	85.20	1404	
	US26	85.20	1400	
	US26D	85.20	1391	
	US32D	99.95	1388	
4932C Replacement Head Cover for 4500 CVR Device	US3	85.20	166447	20
	US4	85.20	166449	
	US10	85.20	166443	
	US10B	85.20	166444	
	US26	85.20	166445	
	US26D	85.20	166446	
	US32D	99.95	166448	





Description	Length	Finish	2021 List	Stock No.	Case Qty.
4932R Replacement Head Cover for 4500 Rim Device		US3	85.20	105036	20
		US4	85.20	105037	
		US10	85.20	105038	
		US10B	85.20	105039	
		US26	85.20	105040	
		US26D	85.20	105041	
		US32D	99.95	105042	
4932S Replacement Head Cover for 4500 SVR Device		US3	85.20	105043	20
		US4	85.20	105044	
		US10	85.20	105045	
		US10B	85.20	105046	
		US26	85.20	105047	
		US26D	85.20	105048	
		US32D	99.95	105049	
4936 24" Extension Rod Kit Includes 24" extension rod, rod connector, rod guide, and wood and machine screws.		US3	30.05	129372	24
		US4	30.05	129373	
		US10	30.05	129374	
		US10B	30.05	129375	
		US26	30.05	129376	
		US26D	30.05	129377	
		US32D	30.05	129378	
4937 36" Extension Rod Kit Includes 36" extension rod, rod connector, rod guide, and wood and machine screws.		US3	33.90	129381	24
		US4	33.90	-	
		US10	33.90	-	
		US10B	33.90	129384	
		US26	33.90	129385	
		US26D	33.90	129386	
		US32D	33.90	129387	
4940 Alarm Kit for 4500 Series Latchbolt monitor switch and tamper switch available. See page 29.	36"	US3	401.25	137621	24
		US4	401.25	137622	
		US10	401.25	137623	
		US10B	401.25	137595	
		US26	401.25	137624	
		US26D	401.25	137596	
		US32D	401.25	137597	
	48"	US3	401.25	164020	24
		US4	401.25	164029	
		US10	401.25	-	
		US10B	401.25	164008	
		US26	401.25	-	
		US26D	401.25	164016	
		US32D	401.25	164025	

1. Items with the price in **bold and red** are Quick Ship items and ship in 24 hours.
Please use stock number when ordering. 2. U/M is each unless otherwise noted.



Exit Devices - 4500



Description	Finish	2021 List	Stock No.	Case Qty.
4945 Top Strike Standard for 4501 CVR	US32D	46.45	150417	
4945F Fire Rated Top Strike for 4501 CVR	US32D	57.35	150418	
2-649-0031 Rod Guide Replacement Pack	US3	9.35	3478	
2-649-0032 Rod Guide Replacement Pack	US4	9.35	3477	
2-649-0033 Rod Guide Replacement Pack	US10	9.35	3476	
2-649-0034 Rod Guide Replacement Pack	US10B	9.35	3473	
2-649-0035 Rod Guide Replacement Pack	US26	9.35	3467	
2-649-0036 Rod Guide Replacement Pack	US26D	9.35	3466	
2-649-0037 Rod Guide Replacement Pack	US32D	9.35	3464	
2-649-0038 End Cap Replacement	US3	30.05	3462	
2-649-0039 End Cap Replacement	US4	30.05	3454	
2-649-0040 End Cap Replacement	US10	30.05	3452	
2-649-0041 End Cap Replacement	US10B	30.05	3435	
2-649-0042 End Cap Replacement	US26	30.05	3433	
2-649-0043 End Cap Replacement	US26D	30.05	3424	
2-649-0044 End Cap Replacement	US32D	30.05	3414	
2-649-0218 Flush End Cap	US3	35.00	182923	
2-649-0220 Flush End Cap	US4	35.00	182925	
2-649-0214 Flush End Cap	US10	35.00	182919	
2-649-0215 Flush End Cap	US10B	35.00	182920	
2-649-0216 Flush End Cap	US26	35.00	182921	
2-649-0217 Flush End Cap	US26D	35.00	182922	



Description	Finish	2021 List	Stock No.	Case Qty.
2-649-0219 Flush End Cap	US32D	35.00	182924	
Note: All end caps come with bracket and fasteners				
2-649-0049 Spring Cage and Hanging Pin for 4500 Series Escutcheon Trim	-	14.25	3405	
2-649-0060 Top or Bottom Latch Cover Replacement Pack	US3	53.55	3333	
2-649-0061 Top or Bottom Latch Cover Replacement Pack	US4	53.55	3306	
2-649-0062 Top or Bottom Latch Cover Replacement Pack	US10	53.55	3304	
2-649-0063 Top or Bottom Latch Cover Replacement Pack	US10B	53.55	3299	
2-649-0064 Top or Bottom Latch Cover Replacement Pack	US26	53.55	3297	
2-649-0065 Top or Bottom Latch Cover Replacement Pack	US26D	53.55	3296	
2-649-0066 Top or Bottom Latch Cover Replacement Pack	US32D	53.55	3295	
2-649-0074 SVR Screwpack - Latch, rod, rod connector, rod guide	US3	8.20	103548	
2-649-0075 SVR Screwpack - Latch, rod, rod connector, rod guide	US4	8.20	103550	
2-649-0076 SVR Screwpack - Latch, rod, rod connector, rod guide	US10	8.20	103551	
2-649-0077 SVR Screwpack - Latch, rod, rod connector, rod guide	US10B	8.20	103552	
2-649-0078 SVR Screwpack - Latch, rod, rod connector, rod guide	US26	8.20	103553	
2-649-0079 SVR Screwpack - Latch, rod, rod connector, rod guide	US26D	8.20	103554	
2-649-0080 SVR Screwpack - Latch, rod, rod connector, rod guide	US32D	8.20	103555	
2-649-0081 SVR Screwpack - Top and bottom strike	-	4.95	103556	



1. Items with the price in **bold and red** are Quick Ship items and ship in 24 hours.
Please use stock number when ordering. 2. U/M is each unless otherwise noted.



Exit Devices - 4500



Description	Finish	2021 List	Stock No.	Case Qty.
2-649-0082 Screwpack - Chassis, end cap, head cover, rim strike (4500 & 4600 Series)	US3	14.80	103558	
2-649-0083 Screwpack - Chassis, end cap, head cover, rim strike (4500 & 4600 Series)	US4	14.80	103559	
2-649-0084 Screwpack - Chassis, end cap, head cover, rim strike (4500 & 4600 Series)	US10	14.80	103560	
2-649-0085 Screwpack - Chassis, end cap, head cover, rim strike (4500 & 4600 Series)	US10B	14.80	103561	
2-649-0086 Screwpack - Chassis, end cap, head cover, rim strike (4500 & 4600 Series)	US26	14.80	103562	
2-649-0087 Screwpack - Chassis, end cap, head cover, rim strike (4500 & 4600 Series)	US26D	14.80	103563	
2-649-0088 Screwpack - Chassis, end cap, head cover, rim strike (4500 & 4600 Series)	US32D	14.80	103582	
2-649-0166 Firebolt Kit for Fire Rated 4500 Series LBR and CLB devices. Includes fire bolt, plastic plug, head cover plug, screws, and instructions. Must use firebolt with fire rated pairs of less bottom rod vertical rod devices to ensure the device's fire rating.	-	55.20	124539	
2-649-0167 LBR Replacement Head Cover Plug Shipped standard if device ordered as LBR	-	8.20	124540	
2-649-0168 Latchbolt Monitor Switch for 4940 and 4941 Alarm Kits	-	137.65	124228	
2-649-0177 Rod to Rod Connector	US3	8.20	129398	
2-649-0178 Rod to Rod Connector	US4	8.20	-	
2-649-0179 Rod to Rod Connector	US10	8.20	-	
2-649-0180 Rod to Rod Connector	US10B	8.20	129401	
2-649-0181 Rod to Rod Connector	US26	8.20	129402	
2-649-0182 Rod to Rod Connector	US26D	8.20	129403	
2-649-0183 Rod to Rod Connector	US32D	8.20	129404	





Description	Finish	2021 List	Stock No.	Case Qty.
2-649-0406 45PN/47PN Cylinder Cup Spacer	-	8.80	182414	
2-649-1074 Hex Key for Dogging 5/32" 10 pack	-	6.05	122690	
2-649-1090 Tamper Switch for 4940 and 4941 alarm kits	-	137.65	137590	
2-649-1108 4501 CVR Top Latch Assembly Replacement Kit	-	83.05	-	
2-649-1109 4501 CVR Bottom Latch Assembly Replacement Kit	-	83.05	150416	
2-649-0440 4500 Series Mortise Exit Strike	US10B	25.15	070809	
2-649-0441 4500 Series Mortise Exit Strike	US26D	25.15	070801	
2-649-0442 4500 Series Mortise Exit Strike	US32D	25.15	070791	
2-649-0443 4500 Series Fire Rated Mortise Exit Strike	US10B	25.15	070792	
2-649-0444 4500 Series Fire Rated Mortise Exit Strike	US26D	25.15	070793	
2-649-0445 4500 Series Fire Rated Mortise Exit Strike	US32D	25.15	070788	
2-649-0250 4500/4600 Series 36" Photoluminescent Push Bar		250.00	185696	
2-649-0257 4500/4600 Series 48" Photoluminescent Push Bar		300.00	185792	

1. Items with the price in **bold and red** are Quick Ship items and ship in 24 hours.
Please use stock number when ordering. 2. U/M is each unless otherwise noted.



Exit Devices - 4600

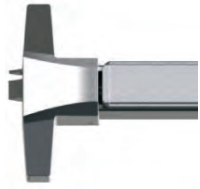

Description	Length	Finish	2021 List	Stock No.	List Fire Rated	Stock No.	Case Qty.
4601 RIM	36"	US3	1,428.10	158394	1,596.80	158413	3
Narrow Stile Rim	Exit Only	US4	1,428.10	158396	1,596.80	158347	
Grade 1		US10	1,428.10	158388	1,596.80	-	
Non-Handed		US10B	1,428.10	158343	1,596.80	158345	
		US26	1,428.10	158390	1,596.80	158411	
For cylinder dogging (specify CD), add \$43.10 to the list price. 3902 mortise cylinder with standard cam must be ordered separately.		US26D	1,308.00	158324	1,464.70	158412	
		US32D	1,428.10	158344	1,596.80	158346	
	48"	US3	1,470.70	158401	1,642.60	-	3
	Exit Only	US4	1,470.70	158402	1,642.65	-	
		US10	1,470.70	158397	1,642.65	-	
Refer to page 4 for electric modification pricing.		US10B	1,470.70	158398	1,642.65	-	
		US26	1,470.70	158399	1,642.65	-	
Anti-microbial coating - add \$46.65 to list price.		US26D	1,346.25	156239	1,510.00	-	
		US32D	1,470.70	156240	1,642.65	156242	



4601 CVR (Non-Fire Rated)	36" x 84"	US3 ³	2,020.00	-	-	-	3
Grade 1-	Exit Only	US4 ³	1,990.00	-	-	-	
Non-Handed		US10 ³	2,000.00	-	-	-	
		US10B ³	1,990.00	-	-	-	
Cylinder Dogging (specify CD), add \$43.10 to list price. 3902 mortise cylinder with standard cam must be ordered separately.		US26 ³	2,020.00	-	-	-	
		US26D	1,970.00	040789	-	-	
		US32D	1,990.00	040784	-	-	
		BLK ³	1,990.00	-	-	-	
Refer to page 4 for electric modification pricing.	36" x 96"	US3 ³	2,060.00	-	-	-	3
	Exit Only	US4 ³	2,030.00	-	-	-	
		US10 ³	2,060.00	-	-	-	
Refer to page 25 for extension rod kits for doors over 8 feet in height.		US10B ³	2,030.00	-	-	-	
		US26 ³	2,060.00	-	-	-	
		US26D ³	2,010.00	-	-	-	
		US32D ³	2,030.00	-	-	-	
		BLK ³	2,030.00	-	-	-	
Anti-microbial coating- add \$46.65 to list price	48" x 84"	US3 ³	2,080.00	-	-	-	3
	Exit Only	US4 ³	2,060.00	-	-	-	
		US10 ³	2,080.00	-	-	-	
		US10B ³	2,080.00	-	-	-	
		US26 ³	2,080.00	-	-	-	
		US26D	2,030.00	040783	-	-	
		US32D	2,060.00	040785	-	-	
		BLK ³	2,060.00	-	-	-	
	48" x 96"	US3 ³	2,120.00	-	-	-	3
	Exit Only	US4 ³	2,100.00	-	-	-	
		US10 ³	2,120.00	-	-	-	
		US10B ³	2,120.00	-	-	-	
		US26 ³	2,120.00	-	-	-	
		US26D ³	2,070.00	-	-	-	
		US32D ³	2,100.00	-	-	-	
		BLK ³	2,100.00	-	-	-	

1. Items with the price in **bold and red** are Quick Ship items and ship in 24 hours.
Please use stock number when ordering.
2. U/M is each unless otherwise noted.
3. Available at extended lead time.



Description	Length	Finish	2021 List	Stock No.	Listed Fire Rated	Stock No.	Case Qty.
4601 CLB (Non-Fire Rated) Grade 1 - Non-Handed Cylinder Dogging (specify CD), add \$43.10 to list price. 3902 mortise cylinder with standard cam must be ordered separately.	36" x 84"	US3 ³	2,020.00	-	-	-	3
	Exit Only	US4 ³	1,990.00	-	-	-	-
		US10 ³	2,000.00	-	-	-	-
		US10B ³	1,990.00	-	-	-	-
		US26 ³	2,020.00	-	-	-	-
		US26D	1,970.00	035049	-	-	-
		US32D	1,990.00	035050	-	-	-
BLK ³	1,990.00	-	-	-	-		
Refer to page 4 for electric modification pricing.	36" x 96"	US3 ³	2,060.00	-	-	-	3
	Exit Only	US4 ³	2,030.00	-	-	-	-
		US10 ³	2,060.00	-	-	-	-
		US10B ³	2,030.00	-	-	-	-
		US26 ³	2,060.00	-	-	-	-
		US26D ³	2,010.00	-	-	-	-
		US32D ³	2,030.00	-	-	-	-
BLK ³	2,030.00	-	-	-	-		
Refer to page 25 for extension rod kits for doors over 8 feet in height.	48" x 84"	US3 ³	2,080.00	-	-	-	3
	Exit Only	US4 ³	2,060.00	-	-	-	-
		US10 ³	2,080.00	-	-	-	-
		US10B ³	2,080.00	-	-	-	-
		US26 ³	2,080.00	-	-	-	-
		US26D	2,030.00	035051	-	-	-
		US32D	2,060.00	035052	-	-	-
BLK ³	2,060.00	-	-	-	-		
Anti-microbial coating - add \$46.65 to list price,	48" x 96"	US3 ³	2,120.00	-	-	-	3
	Exit Only	US4 ³	2,100.00	-	-	-	-
		US10 ³	2,100.00	-	-	-	-
		US10B ³	2,120.00	-	-	-	-
		US26 ³	2,120.00	-	-	-	-
		US26D ³	2,070.00	-	-	-	-
		US32D ³	2,100.00	-	-	-	-
BLK ³	2,100.00	-	-	-	-		

1. Items with the price in **bold and red** are Quick Ship items and ship in 24 hours.
Please use stock number when ordering.
2. U/M is each unless otherwise noted.
3. Available at extended lead time.



Exit Devices - 4600



Description	Function	Finish	2021 List	Stock No.	Case Qty.
46BE					
Blank Escutcheon					
Tactile Warning - add \$42.40 to list price.					
Anti-microbial coating - add \$46.65 to list price.					
Archer Lever	14 Always Operable	US3	524.10	-	6
		US4	524.10	-	
		US10	524.10	-	
		US10B	524.10	171033	
		US26	524.10	171089	
		US26D	503.40	171090	
August Lever		US3	524.10	-	6
		US4	524.10	-	
		US10	524.10	-	
		US10B	524.10	-	
		US26	524.10	171088	
		US26D	503.40	171096	
William Lever		US3	524.10	-	6
		US4	524.10	-	
		US10	524.10	-	
		US10B	524.10	171083	
		US26	524.10	-	
		US26D	503.40	171091	
Withnell Lever		US3	524.10	-	6
		US4	524.10	-	
		US10	524.10	-	
		US10B	524.10	171085	
		US26	524.10	-	
		US26D	503.40	171097	



46CE					
Cylinder Escutcheon					
Requires a 3902 mortise cylinder (with 3976 L cam) sold separately.					
Tactile Warning - add \$42.40 to list price.					
Anti-microbial coating - add \$46.65 to list price.					
Archer Lever	08 Key locks or unlocks lever	US3	524.10	-	6
		US4	524.10	171514	
		US10	524.10	171479	
		US10B	524.10	171483	
		US26	524.10	171504	
		US26D	503.40	171508	
August Lever		US3	524.10	-	6
		US4	524.10	-	
		US10	524.10	-	
		US10B	524.10	171503	
		US26	524.10	-	
		US26D	503.40	171212	



Description	Function	Finish	2021 List	Stock No.	Case Qty.
William Lever		US3	524.10	-	6
		US4	524.10	-	
		US10	524.10	-	
		US10B	524.10	171484	
		US26	524.10	-	
		US26D	503.40	171211	
Withnell Lever		US3	524.10	171513	6
		US4	524.10	171518	
		US10	524.10	171482	
		US10B	524.10	171129	
		US26	524.10	171507	
		US26D	503.40	171509	
<hr/>					
46DT					
Dummy Trim					
Tactile Warning - add \$42.40 to list price.					
Anti-microbial coating - add \$46.65 to list price.					
Archer Lever	02	US3	524.10	-	6
	Pull when	US4	524.10	-	
	device is	US10	524.10	171223	
	dogged down	US10B	524.10	171228	
		US26	524.10	171234	
		US26D	503.40	171283	
August Lever		US3	524.10	-	6
		US4	524.10	-	
		US10	524.10	-	
		US10B	524.10	-	
		US26	524.10	-	
		US26D	503.40	171285	
William Lever		US3	524.10	-	6
		US4	524.10	-	
		US10	524.10	-	
		US10B	524.10	171375	
		US26	524.10	-	
		US26D	503.40	-	
Withnell Lever		US3	524.10	-	6
		US4	524.10	171412	
		US10	524.10	-	
		US10B	524.10	171233	
		US26	524.10	171282	
		US26D	503.40	171287	



1. Items with the price in **bold and red** are Quick Ship items and ship in 24 hours.
Please use stock number when ordering. 2. U/M is each unless otherwise noted.



Exit Devices - 4600



Description	Function	Finish	2021 List	Stock No.	Case Qty.
46NK					
Night Lever Escutcheon					
Requires a 3902 mortise cylinder (with 3976 L cam) sold separately.					
Tactile Warning - add \$42.40 to list price.					
Anti-microbial coating - add \$46.65 to list price.					
Archer Lever	09	US3	524.10	172076	6
	Key releases	US4	524.10	172079	
	lever, lever	US10	524.10	171546	
	locked when	US10B	524.10	171550	
	key removed	US26	524.10	171554	
	US26D	503.40	171558		
August Lever		US3	524.10	172077	6
		US4	524.10	172080	
		US10	524.10	171548	
		US10B	524.10	171552	
		US26	524.10	171556	
	US26D	503.40	171560		
William Lever		US3	524.10	172083	6
		US4	524.10	172082	
		US10	524.10	171547	
		US10B	524.10	17551	
		US26	524.10	171555	
	US26D	503.40	171559		
Withnell Lever		US3	524.10	172078	6
		US4	524.10	172081	
		US10	524.10	171549	
		US10B	524.10	171553	
		US26	524.10	171557	
	US26D	503.40	171561		



46NL					
Night Latch					
Requires a 3901 rim cylinder (with long tailpiece) sold separately.					
Maximum door thickness compatibility is 2-1/2" (38mm).					
Tactile Warning - add \$42.40 to list price.					
Anti-microbial coating - add \$46.65 to list price.					
Archer Lever	03	US3	524.10	171538	6
	Key retracts	US4	524.10	-	
	latchbolt	US10	524.10	171523	
		US10B	524.10	171527	
		US26	524.10	-	
	US26D	503.40	171534		
August Lever		US3	524.10	-	6
		US4	524.10	-	
		US10	524.10	-	
		US10B	524.10	171529	
		US26	524.10	171533	
	US26D	503.40	171536		



Description	Length	Finish	2021 List	Stock No.	Case Qty.	
William Lever		US3	524.10	-	6	
		US4	524.10	-		
		US10	524.10	-		
		US10B	524.10	171528		
		US26	524.10	-		
		US26D	503.40	171535		
Withnell Lever		US3	524.10	-	6	
		US4	524.10	171545		
		US10	524.10	171526		
		US10B	524.10	171530		
		US26	524.10	-		
		US26D	503.40	171537		
4920		US32D	72.10	16208	24	
Strike for use with 4500 or 4600 Series Rim Exit Device. Optional - order separately						
4920F		US32D	99.95	16207	24	
Fire rated strike for use with 4500 or 4600 Series Fire Rated Rim Exit Device. Included standard with fire rated device.						
4925R	36"	US3	43.70	157187	48	
		US4	43.70	157191		
		US10	43.70	157192		
		US10B	43.70	157193		
		US26	43.70	-		
		US26D	43.70	157195		
	US32D	43.70	157196			
	48"	US3	45.90	-		36
		US4	45.90	-		
		US10	45.90	-		
US10B		45.90	157200			
		US26	45.90	157201		
		US26D	45.90	157202		
		US32D	45.90	157203		



1. Items with the price in **bold and red** are Quick Ship items and ship in 24 hours.
Please use stock number when ordering. 2. U/M is each unless otherwise noted.



Exit Devices - 4600



Description	Length	Finish	2021 List	Stock No.	Case Qty.
4941R Alarm Kit for 4600 Series Rim Device Latchbolt monitor switch and tamper switch available.	36"	US3	364.70	-	
		US4	364.70	-	
		US10	364.70	-	
		US10B	364.70	-	
		US26	364.70	-	
		US26D	364.70	167349	
		US32D	364.70	167464	
	48"	US3	364.70	-	
		US4	364.70	-	
		US10	364.70	-	
		US10B	364.70	-	
		US26	364.70	-	
		US26D	364.70	147150	
		US32D	364.70	-	
4950 Blade stop strike for use with 4600 Series Rim Exit Device. Included standard with panic rated device.		US32D	72.10	139746	24
4951 Single rabbet strike for use with 4600 Series Rim Exit Device Optional - order separately		US32D	72.10	139748	24
4952 Semi-flush mount strike for use with 4600 Series Rim Exit Device Optional - order separately		US32D	72.10	139747	24
4960R Shim Kit for 4600 Series Rim Exit Device Packaged 2 each 1/8" shims		US3	77.60	139716	24
		US4	77.60	139717	
		US10	77.60	-	
		US10B	77.60	139719	
		US26	77.60	-	
		US26D	77.60	139721	
	US32D	91.25	139722		





Description	Finish	2021 List	Stock No.	Case Qty.
4965R Replacement Head Cover for 4600 Rim Device	US3	77.60	139700	20
	US4	77.60	139707	
	US10	77.60	-	
	US10B	77.60	139709	
	US26	77.60	-	
	US26D	77.60	139711	
	US32D	91.25	139712	
4965C Replacement Head Cover for 4600 CVR/CLB Device	US10B	75.30	166451	20
	US26D	75.30	166453	
	US32D	75.30	166455	
2-649-0218 Flush End Cap	US3	35.00	182923	
2-649-0220 Flush End Cap	US4	35.00	182925	
2-649-0214 Flush End Cap	US10	35.00	182919	
2-649-0215 Flush End Cap	US10B	35.00	182920	
2-649-0216 Flush End Cap	US26	35.00	182921	
2-649-0217 Flush End Cap	US26D	35.00	182922	
2-649-0219 Flush End Cap	US32D	35.00	182924	
Note: All end caps come with bracket and fasteners				
2-649-0168 Latchbolt Monitor Switch for 4940 and 4941 Alarm Kits	-	137.65	124228	
2-649-1074 Hex Key for Dogging 5/32" 10 pack	-	5.50	122690	
2-649-1090 Tamper Switch for 4940 and 4941 Alarm Kits	-	137.65	137590	

1. Items with the price in **bold and red** are Quick Ship items and ship in 24 hours. Please use stock number when ordering. 2. U/M is each unless otherwise noted.



Exit Devices - 4600



Description	Finish	2021 List	Stock No.	Case Qty.
4929C 4929 CVR/CLB Rod Replacement PK 46-5/8" US26D (4500/4600)	-	56.65	165570	
2-649-0596 4600 CVR Bottom Strike Packaged Assembly	-	27.81	0039704	
2-649-0598 4600 CVR Top Strike Packaged Assembly	-	27.81	039700	
2-649-0581 4600 CVR Top Latch Assembly (no screws)	-	95.79	039696	
2-649-0582 4600 CVR Bottom Latch Assembly (no screws)	-	98.70	039697	
2-649-0580 4600 CVR Rod Connector Pack	-	15.45	039698	
2-649-0597 4600 Exit Device Chassis Screw Pack	-	6.18	039685	
2-649-0598 4600 CVR Latch Screw Pack, 26D	26D	5.15	039682	
2-649-0589 4600 CVR Latch Screw Pack, 32D	32D	5.15	039675	
2-649-0583 4600 CVR Latch Screw Pack, US3	US3	5.15	039671	
2-649-0584 4600 CVR Latch Screw Pack, US4	US4	5.15	039664	
2-649-0585 4600 CVR Latch Screw Pack, US10	US10	5.15	039661	
2-649-0586 4600 CVR Latch Screw Pack, US10B	US10B	5.15	039658	
2-649-0587 4600 CVR Latch Screw Pack, US26	US26	5.15	039655	
2-649-0590 4600 CVR Latch Screw Pack, BLK	BLK	5.15	039652	



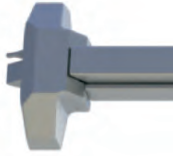

Description	Length	Finish	2021 List	Stock No.	List Fire Rated	Stock No.	Case Qty.
4701 RIM Standard Duty Non-Handed	36" Exit Only	ALM	312.30	098945	429.10	098474	3
		DBZ	312.30	098823	429.10	098430	
		US3	526.30	099106	646.40	098531	
		US32D	526.30	015815	646.40	098530	
	48" Exit Only	ALM	351.60	098778	470.05	098389	3
		DBZ	351.60	098544	470.05	098387	
		US3	565.60	016113	684.05	098411	
		US32D	565.60	098788	684.05	098402	
4701 SVR Standard Duty Non-Handed SVR panic devices available on 10' openings. Order extension rod kits separately.	36" x 84" Exit Only	ALM	507.70	131988	701.55	132156	3
		DBZ	507.70	132022	701.50	132151	
		US3	722.85	131955	917.15	085302	
		US32D	722.85	131984	917.15	132153	
	36" x 96" Exit Only	ALM	548.15	132035	741.95	132156	3
		DBZ	548.15	132058	741.95	132183	
		US3	760.45	118174	956.50	085279	
		US32D	760.45	132026	956.50	132153	
	48" x 84" Exit Only	ALM	565.60	085312	760.45	132191	3
		DBZ	565.60	085281	760.45	118199	
		US3	765.40	118178	974.45	118195	
		US32D	765.40	132063	974.45	132186	
	48" x 96" Exit Only	ALM	585.25	132091	780.65	132193	3
		DBZ	585.25	098945	780.65	085299	
		US3	800.90	011813	996.30	085301	
		US32D	800.90	132073	996.30	085268	



Description	Function	Finish	2021 List	Stock No. LHR	2021 List	Stock No. RHR	Case Qty.	
47BE Blank Escutcheon Must specify handing Steel body, zinc lever (US32D has stainless steel cover). For doors thicker than 1-3/4" or when used with a shim kit, specify total door thickness. Tactile Warning - add \$42.40 to list price of item.	Archer Lever	14	ALM	248.40	92763	248.40	92825	6
		Always	DBZ	248.40	92760	248.40	92774	
		Operable	US3	271.40	92764	271.40	92846	
			US32D	271.40	92772	271.40	92889	
	August Lever		ALM	248.40	107647	248.40	107648	6
			DBZ	248.40	107650	248.40	107649	
			US3	271.40	107640	271.40	107643	
			US32D	271.40	107645	271.40	107646	
	Withnell Lever		ALM	248.40	92917	248.40	93139	6
			DBZ	248.40	92906	248.40	93083	
		US3	271.40	92918	271.40	93173		
		US32D	271.40	92919	271.40	93199		

1. Items with the price **bold and red** are Quick Ship items and ship in 24 hours. Please use stock number when ordering. 2. U/M is each unless otherwise noted.



Exit Devices - 4700



Description	Function	Finish	2021 List	Stock No. LHR	2021 List	Stock No. RHR	Case Qty.
47CE							
Cylinder Escutcheon							
Must specify handing							
Requires a 3902 mortise cylinder (with standard cam) sold separately.							
Steel body, zinc lever (US32D has stainless steel cover).							
For doors thicker than 1-3/4" or when used with a shim kit, specify total door thickness.							
Tactile Warning - add \$42.40 to list price of item.							
Archer Lever	08	ALM	248.40	93208	248.40	93829	6
	Key locks or unlocks lever	DBZ	248.40	93206	248.40	93819	
		US3	271.40	93219	271.40	93903	
		US32D	271.40	93220	271.40	93913	
August Lever		ALM	248.40	107658	248.40	107659	6
		DBZ	248.40	107660	248.40	107661	
		US3	271.40	107652	271.40	107654	
		US32D	271.40	107655	271.40	107657	
Withnell Lever		ALM	248.40	93778	248.40	95104	6
		DBZ	248.40	93765	248.40	95004	
		US3	271.40	93786	271.40	95118	
		US32D	271.40	93801	271.40	95143	



47DT							
Dummy Trim							
Must specify handing							
Steel body, zinc lever (US32D has stainless steel cover).							
For doors thicker than 1-3/4" or when used with a shim kit, specify total door thickness.							
Tactile Warning - add \$42.40 to list price of item.							
Archer Lever	02	ALM	248.40	92290	248.40	92306	6
	Pull when device is dogged down	DBZ	248.40	92257	248.40	92304	
		US3	271.40	92291	271.40	92320	
		US32D	271.40	92293	271.40	92322	
August Lever		ALM	248.40	107675	248.40	107674	6
		DBZ	248.40	107676	248.40	107677	
		US3	271.40	107669	271.40	107670	
		US32D	271.40	107671	271.40	107673	
Withnell Lever		ALM	248.40	92325	248.40	92391	6
		DBZ	248.40	92324	248.40	92386	
		US3	271.40	92367	271.40	92392	
		US32D	271.40	92189	271.40	92396	





Description	Function	Finish	2021 List	Stock No. LHR	2021 List	Stock No. RHR	Case Qty.
47NL							
Night Latch							
Must specify handing							
Requires a 3902 mortise cylinder (sold separately) with standard cam.							
Steel body, zinc lever (US32D has stainless steel cover).							
For doors thicker than 1-3/4" or when used with a shim kit, specify total door thickness.							
Tactile Warning - add \$42.40 to list price of item.							
Archer Lever	03	ALM	248.40	160645	248.40	92500	6
	Key retracts latchbolt	DBZ	248.40	160657	248.40	92499	
		US3	271.40	160622	271.40	92531	
		US32D	271.40	160629	271.40	92532	
August Lever	ALM	248.40	160655	248.40	160656	6	
	DBZ	248.40	160664	248.40	160665		
	US3	271.40	160627	271.40	160628		
	US32D	271.40	160643	271.40	160644		
Withnell Lever	ALM	248.40	160649	248.40	160652	6	
	DBZ	248.40	160660	248.40	160662		
	US3	271.40	160624	271.40	160626		
	US32D	271.40	160637	271.40	160640		



Description	Function	Finish	2021 List	Stock No. Fixed Cyl	2021 List	Stock No. SFIC Hous.	Case Qty.
47KD							
Dummy Trim							
Steel body and zinc lever (US32D stainless steel rose).							
Tactile Warning - add \$42.40 to list price of item.							
Archer Lever	02	ALM	225.00	109800	-	-	12
	Entrance by trim when device is dogged down	DBZ	225.00	109801	-	-	
		US3	248.40	109802	-	-	
		US32D	248.40	109803	-	-	
August Lever	ALM	225.00	109804	-	-	12	
	DBZ	225.00	109805	-	-		
	US3	248.40	109806	-	-		
	US32D	248.40	109807	-	-		
Withnell Lever	ALM	225.00	109808	-	-	12	
	DBZ	225.00	109809	-	-		
	US3	248.40	109810	-	-		
	US32D	248.40	109811	-	-		

1. Items with the price in **bold and red** are Quick Ship items and ship in 24 hours. Please use stock number when ordering. 2. U/M is each unless otherwise noted.



Exit Devices - 4700



Description	Function	Finish	2021 List	Stock No. Fixed Cyl	2021 List	Stock No. SFIC Hous.	Case Qty.
47KE							
Entrance							
Fixed cylinder standard or SFIC housing option for levers (SFIC cores sold separately, refer to locks section).							
Steel body and zinc lever or knob (US32D stainless steel rose).							
Tactile Warning - add \$42.40 to list price of item.							
Archer Lever	08	ALM	248.40	169423	248.40	169422	12
	Entrance by trim	DBZ	248.40	169430	248.40	169429	
	key locks or unlocks trim	US3	271.40	169436	271.40	169435	
		US32D	271.40	169442	271.40	169441	
August Lever		ALM	248.40	169426	248.40	169424	12
		DBZ	248.40	169432	248.40	169431	
		US3	271.40	169438	271.40	-	
		US32D	271.40	169444	271.40	169443	
Withnell Lever		ALM	248.40	169428	248.40	169427	12
		DBZ	248.40	169434	248.40	169433	
		US3	271.40	169440	271.40	169439	
		US32D	271.40	169446	271.40	169445	
Apollo Knob							
(not ADA compliant)							

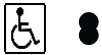

47KN							
Night Latch							
Fixed cylinder standard or SFIC housing option for levers (SFIC cores sold separately, refer to locks section).							
Steel body, zinc lever or knob (US32D stainless steel rose).							
Tactile Warning - add \$42.40 to list price of item.							
Archer Lever	03	ALM	248.40	127486	248.40	109767	12
	Key retracts latchbolt	DBZ	248.40	127489	248.40	109768	
		US3	271.40	127480	271.40	109769	
		US32D	271.40	127483	271.40	109770	
August Lever		ALM	248.40	127487	248.40	109775	12
		DBZ	248.40	127490	248.40	109776	
		US3	271.40	127481	271.40	109777	
		US32D	271.40	127484	271.40	109778	
Withnell Lever		ALM	248.40	127488	248.40	109783	12
		DBZ	248.40	127491	248.40	109784	
		US3	271.40	127482	271.40	109785	
		US32D	271.40	127485	271.40	109786	
Apollo Knob							
(not ADA compliant)							





Description	Function	Finish	2021 List	Stock No. Fixed Cyl	2021 List	Stock No. SFIC Hous.	Case Qty.
47KP Passage Steel body, zinc lever (US32D stainless steel rose). Tactile Warning - add \$42.40 to list price of item.							
Archer Lever	14	ALM	225.00	109788	-	-	12
	Always operable	DBZ	225.00	109789	-	-	
		US3	248.40	109790	-	-	
		US32D	248.40	109791	-	-	
August Lever	ALM		225.00	109792	-	-	12
	DBZ		225.00	109793	-	-	
	US3		248.40	109794	-	-	
	US32D		248.40	109795	-	-	
Withnell Lever	ALM		225.00	109796	-	-	12
	DBZ		225.00	109797	-	-	
	US3		248.40	109798	-	-	
	US32D		248.40	109799	-	-	

Description	Function	Finish	2021 List	Stock No.	Stock No.	Case Qty.
47BT Pull Plate Thumb Piece Passage Must specify handing Tactile Warning - add \$42.40 to list price of item.	14 Always Operable	US32D	274.10	168977	168976	6
47PT Pull Plate Thumb Piece Entrance Must specify handing Tactile Warning - add \$40.00 to list price of item.	05 Key locks or unlocks thumb piece	US32D	274.10	159296	159297	6
47PD Pull Plate - Dummy Trim Plated steel for ALM, DBZ, and US3. Stainless steel for US32D. Tactile Warning - add \$42.40 to list price of item.	02	ALM	111.95	109019		12
	Pull when device is dogged down	DBZ	111.95	109020		
		US3	111.95	109021		
		US32D	111.95	109022		
47PN Pull Plate - Night Latch Requires a 3901 rim cylinder (sold separately). Includes retaining cup for 161 door prep. Plated steel for ALM, DBZ, and US3. Stainless steel for US32D. Tactile Warning - add \$42.40 to list price of item.	03	ALM	128.90	109023		12
	Key retracts latchbolt	DBZ	128.90	109026		
		US3	128.90	109027		
		US32D	128.90	109028		

1. Items with the price in **bold and red** are Quick Ship items and ship in 24 hours.
Please use stock number when ordering. 2. U/M is each unless otherwise noted.



Exit Devices - 4700

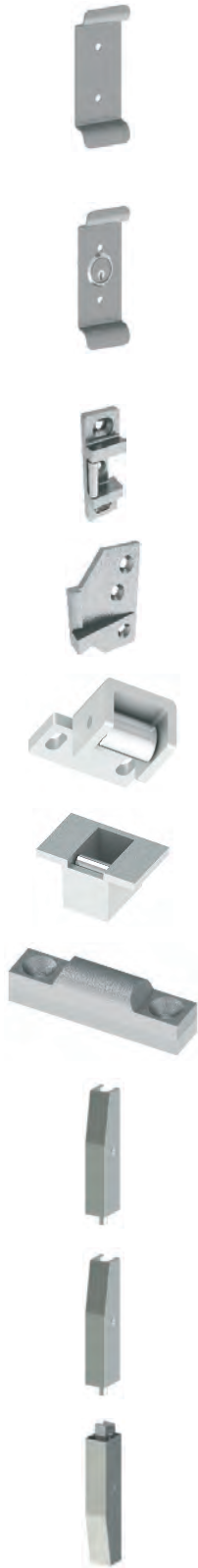

Description	Function	Finish	2021 List	Stock No.	Case Qty.
47RD Raised Lip Pull - Dummy Trim Plated steel for ALM, DBZ, and US3. Stainless steel for US32D. Tactile Warning - add \$42.40 to list price of item.	02	ALM	62.30	18956	12
	Pull when device is dogged down	DBZ	62.30	18949	
		US3	62.30	18934	
		US32D	62.30	18933	
47RN Raised Lip Pull - Night Latch Requires a 3901 rim cylinder (sold separately). Tactile Warning - add \$42.40 to list price of item.	03	ALM	69.40	177051	12
	Key retracts latchbolt	DBZ	69.40	177053	
		US3	69.40	018885	
		US32D	69.40	177050	
4910 Strike for use with 4700 Rim Exit Device Included standard with device.		US32D	69.40	20040	24
4911 Double door strike for 4700 Surface Vertical Rod and Rim Exit Device. Not for fire-rated door. Optional - order separately.		DBZ	62.30	19301	24
		US3	62.30	19323	
		US32D	62.30	19322	
4913 Top strike for 4700 Surface Vertical Rod Exit Device Included standard with device.		US32D	44.25	16231	24
4914 Bottom strike for 4700 Surface Vertical Rod Device Included standard with device.		US32D	44.25	16213	24
4915 Threshold strike for use with 4500 Series or 4700 Series. Not for fire-rated doors. Optional order separately.		US32D	25.70	67426	48
4917 Bottom Latch Assembly Includes latch, cover and screws. Included standard with panic-rated device.		ALM	65.00	56412	50
		DBZ	65.00	56401	
		US3	65.00	56400	
		US32D	65.00	56398	
4917F Bottom Latch Assembly Includes latch, cover and screws. Included standard with fire-rated device.		ALM	65.00	179943	50
		DBZ	65.00	179944	
		US3	65.00	179941	
		US32D	65.00	179942	
4918 Top Latch Assembly Includes latch, cover and screws. Included standard with device.		ALM	65.00	56418	50
		DBZ	65.00	56410	
		US3	65.00	56409	
		US32D	65.00	56407	





Description	Length	Finish	2021 List	Stock No.	Case Qty.
4919 Rod Replacement Kit (top or bottom) Includes rod (47-1/4"), rod guide, rod connector assembly and all appropriate screws.		ALM	32.80	73587	24
		DBZ	32.80	73574	
		US3	32.80	73568	
		US32D	32.80	73530	
4931R Shim Kit for 4700 Series Rim Device Packaged 2 ea. 1/8" shims. If using with 47BE, 47CE, 47NL trim, please specify thickness (door plus shim).		ALM	56.85	101773	24
		DBZ	56.85	101774	
		US3	65.00	101775	
		US32D	65.00	101776	
4931S Shim Kit for 4700 Series Surface Vertical Rod Device Packaged 2 ea. 1/8" shims. If using with 47BE, 47CE, 47NL trim, please specify thickness (door plus shim).		ALM	56.85	101783	24
		DBZ	56.85	101784	
		US3	65.00	101786	
		US32D	65.00	101787	
4933R Replacement Head Cover for 4700 Series Rim Device		ALM	40.95	105050	20
		DBZ	40.95	105051	
		US3	47.55	105052	
		US32D	47.55	105053	
4933S Replacement Head Cover for 4700 Series SVR Device		ALM	40.95	105054	20
		DBZ	40.95	105055	
		US3	47.55	105056	
		US32D	47.55	105057	
4934 Replacement Dogging Plate for 4700 Series Panic Rated Device	36"	ALM	32.80	105058	20
		DBZ	32.80	105059	
		US3	32.80	105060	
		US32D	32.80	105061	
	48"	ALM	37.15	105062	20
		DBZ	37.15	105063	
		US3	37.15	105064	
		US32D	37.15	105065	
4934F Replacement Dogging Plate for 4700 Series Fire Rated Device	36"	ALM	32.80	105066	20
		DBZ	32.80	105076	
		US3	32.80	105068	
		US32D	32.80	105069	
	48"	ALM	37.15	105070	20
		DBZ	37.15	105071	
		US3	37.15	105072	
		US32D	37.15	105073	
4936 24" Extension Rod Kit Includes 24" extension rod, rod connector, rod guide, and wood and machine screws. Fire rated up to 8' on Surface Vertical Rod device.		ALM	28.95	129379	24
		DBZ	28.95	129380	
		US3	30.05	129372	
		US32D	30.05	129378	
4937 36" Extension Rod Kit Includes 36" extension rod, rod connector, rod guide, and wood and machine screws. Fire rated up to 8' on Surface Vertical Rod device.		ALM	32.80	129388	24
		DBZ	32.80	129389	
		US3	33.90	129381	
		US32D	33.90	129387	

1. Items with the price in **bold and red** are Quick Ship items and ship in 24 hours.
Please use stock number when ordering. 2. U/M is each unless otherwise noted.



Exit Devices - 4700



Description	Finish	2021 List	Stock No.	Case Qty.
2-649-0010 Rod Guide Replacement	US3	8.20	56131	
2-649-0011 Rod Guide Replacement	US32D	8.20	56026	
2-649-0012 Rod Guide Replacement	DBZ	8.20	56025	
2-649-0013 Rod Guide Replacement	ALM	8.20	56027	
2-649-0014 Trim Handing Pin - 5 pack	-	8.20	52275	
2-649-0021 Top Latch Cover	ALM	35.50	56389	
2-649-0022 Top Latch Cover	DBZ	35.50	56388	
2-649-0023 Top Latch Cover	US3	35.50	56376	
2-649-0024 Top Latch Cover	US32D	35.50	56375	
2-649-0025 Bottom Latch Cover	ALM	35.50	56331	
2-649-0026 Bottom Latch Cover	DBZ	35.50	56328	
2-649-0027 Bottom Latch Cover	US3	35.50	56319	
2-649-0028 Bottom Latch Cover	US32D	35.50	56296	
2-649-0095 SVR Screwpack - Latch, rod, rod connector, rod guide	ALM	8.20	103572	
2-649-0096 SVR Screwpack - Latch, rod, rod connector, rod guide	DBZ	8.20	103573	
2-649-0097 SVR Screwpack - Latch, rod, rod connector, rod guide	US3	8.20	103574	
2-649-0098 SVR Screwpack - Latch, rod, rod connector, rod guide	US32D	8.20	103575	
2-649-0099 SVR Screwpack - Top and bottom strike	-	4.95	103576	
2-649-0100 Screwpack - Chassis, end cap, head cover, rim strike	ALM	14.25	103577	
2-649-0101 Screwpack - Chassis, end cap, head cover, rim strike	DBZ	14.25	103578	
2-649-0102 Screwpack - Chassis, end cap, head cover, rim strike	US3	14.25	103579	



Description	Finish	2021 List	Stock No.	Case Qty.
2-649-0103 Screwpack - Chassis, end cap, head cover, rim strike	US32D	14.25	103580	
2-649-0141 Screwpack - 2" thick door, trim	-	2.75	103606	
2-649-0142 Screwpack - 2-1/4" thick door, trim	-	2.75	103607	
2-649-0144 End Cap Replacement Pack	ALM	17.55	104043	
2-649-0145 End Cap Replacement Pack	DBZ	17.55	104044	
2-649-0146 End Cap Replacement Pack	US3	17.55	104045	
2-649-0147 End Cap Replacement Pack	US32D	17.55	104046	
Note: All end caps come with bracket and fasteners				
2-649-0164 Pack of 8 Screws, trim (4700), 1/4 - 20 x 3/4" PHMS	-	8.20	112534	
2-649-0177 Rod to Rod Connector	US3	8.20	129398	
2-649-0183 Rod to Rod Connector	US32D	8.20	129404	
2-649-0184 Rod to Rod Connector	ALM	8.20	129405	
2-649-0185 Rod to Rod Connector	DBZ	8.20	-	
2-649-0406 45PN/47PN Cylinder Cup Spacer	-	8.80	182414	
2-649-4703 Hex Key for Dogging 3/16" 10 pack	-	6.05	315	



1. Items with the price in **bold and red** are Quick Ship items and ship in 24 hours. Please use stock number when ordering. 2. U/M is each unless otherwise noted.



Exit Devices - 4700



Description	Height	Finish	2021 List	Stock No.	List Fire Rated	Stock No.	Case Qty.
4900U Non-Keyed Removable Mullion Set 11 Gauge Steel Tube, top bracket/ bottom bracket set Fire rated mullion requires a fire rated strike (sold separately).	7'	USP	516.45	133007	772.45	133010	1
	8'	USP	516.45	133008	772.45	133011	1
	10'	USP	644.20	133009		-	1
4904 Top/Bottom Bracket Set Removable (Non-Keyed)		-	226.55	133029	278.45	133031	5
4905 Mullion Tube (Non-Keyed) 11 Gauge Steel	7'	USP	331.45	133032		-	1
	8'	USP	331.45	133033		-	1
	10'	USP	410.60	133034		-	1
4912 Fire rated strike for use with 4500 Series and 4600 Series Fire Rated Exit Device and Mullion		US32D		-	141.95	16232	24
4916 Fire rated strike for use with 4700 Series Fire Rated Exit Device and Mullion		US32D		-	141.95	115780	24
4953 Mullion Stabilizer for use with 4900 Series Non-Keyed and Keyed Removable Mullion		US32D		-	55.75	139749	12





Description	Height	Finish	2021 List	Stock No.	List Fire Rated	Stock No.	Case Qty.
4900T Keyed Removable Mullion Set 11 gauge steel tube, top bracket/ bottom bracket set.	7'	USP	1,065.10	132391	1,260.55	132393	1
	8'	USP	1,065.10	132392	1,260.55	132394	1
	10'	USP	1,227.80	132390	-	-	1
Requires a 3901 rim cylinder (sold separately).							
Fire rated mullion requires a fire rated strike (sold separately).							
4902 Top/Bottom Bracket Set Key Removable		-	654.60	45351	810.70	31750	5
Requires a 3901 rim cylinder (sold separately).							
4907 Mullion Tube (Key Removable) 11 Gauge Steel	7'	USP	441.70	45349	-	-	1
	8'	USP	441.70	45334	-	-	1
	10'	USP	574.35	45323	-	-	1
4912 Fire rated strike for use with 4500 Series and 4600 Series Fire Rated Device and Mullion		US32D	-	-	141.95	16232	24
4916 Fire rated strike for use with 4700 Series Fire Rated Exit Device and Mullion		US32D	-	-	141.95	115780	24
4953 Mullion Stabilizer for use with 4900 Series Non-Keyed and Keyed Removable Mullion		US32D	-	-	55.75	139749	12
3901 Rim Cylinder Fixed cylinder and Small Format Interchangeable Core housing available (SFIC cores sold separately). Dummy rim cylinders also available.		US3	50.00	-	-	-	1
		US4	53.10	-	-	-	-
		US10	53.10	-	-	-	-
		US10B	50.00	-	-	-	-
		US26	50.00	-	-	-	-
	US26D	50.00	-	-	-	-	
Shipped standard with long break-off tailpiece.							
Specify 6-pin or 7-pin for SFIC housing.							
For additional cylinder information, please refer to the Locks section.							

1. Items with the price in **bold and red** are Quick Ship items and ship in 24 hours. Please use stock number when ordering. 2. U/M is each unless otherwise noted.



Exit Devices - 4700



Description	Finish	2021 List	Stock No.	Case Qty.
3902 Mortise Cylinder Fixed cylinder and Small Format Interchangeable Core housing available (SFIC cores sold separately). Dummy mortise cylinders also available.	US3	50.00		1
	US4	53.10		
	US10	53.10		
	US10B	50.00		
	US26	50.00		
	US26D	50.00		
Shipped with Schlage C keyway, standard cam attached, and Adams Rite cam loose in box.				
Specify length 1-1/8" or 1-1/4" for fixed cylinder or 1-1/4" (6-pin) or 1-3/8" (7-pin) for SFIC housing and cam required.				
For mortise exit device trim specify 1-5/8" with standard cam for fixed cylinder (Schlage C Keyway) or SFIC housing.				
For mortise exit device x cylinder/optional pull, use 1-3/8" cylinder with 11/16" cylindrical collar.				
For additional cylinder information, please refer to the Locks section.				
2-649-0137 Retaining Cup For use with Rim cylinder and 161 prep	NF	9.85	103365	
2-649-0045 7/16" Cylinder Collar (4500 Pull Plate Trim)	US3	19.10	3404	
2-649-0046 7/16" Cylinder Collar (4500 Pull Plate Trim)	US4	19.10	3395	
2-649-0047 7/16" Cylinder Collar (4500 Pull Plate Trim)	US10	19.10	3394	
2-649-0048 7/16" Cylinder Collar (4500 Pull Plate Trim)	US10B	19.10	3393	
2-649-0050 7/16" Cylinder Collar (4500 Pull Plate Trim)	US26	19.10	3386	
2-649-0051 7/16" Cylinder Collar (4500 Pull Plate Trim)	US26D	19.10	3384	
2-649-0052 7/16" Cylinder Collar (4500 Pull Plate Trim)	US32D	19.70	3381	
Note: For use with 1-1/8" mortise cylinders Note: All cylinder collars come with wave washer and spacer				
2-649-0053 11/16" Cylinder Collar (4500 Escutcheon Trim)	US3	19.10	3380	
2-649-0054 11/16" Cylinder Collar (4500 Escutcheon Trim)	US4	19.10	3357	
2-649-0055 11/16" Cylinder Collar (4500 Escutcheon Trim)	US10	19.10	3346	
2-649-0056 11/16" Cylinder Collar (4500 Escutcheon Trim)	US10B	19.10	3340	
2-649-0057 11/16" Cylinder Collar (4500 Escutcheon Trim)	US26	19.10	3339	





Description	Finish	2021 List	Stock No.	Case Qty.
2-649-0058 1 1/16" Cylinder Collar (4500 Escutcheon Trim)	US26D	19.10	3335	
2-649-0059 1 1/16" Cylinder Collar (4500 Escutcheon Trim)	US32D	19.10	3334	
Note: For use with 1-1/4" or 1-3/8" mortise cylinders Note: All cylinder collars come with wave washer and spacer				
2-647-0012 7/8" Cylinder Collar - 5, 6, 7 pin (4700 Escutcheon Trim)	US3	19.10	31809	
2-647-0013 7/8" Cylinder Collar - 5, 6, 7 pin (4700 Escutcheon Trim)	ALM	19.10	31804	
2-647-0014 7/8" Cylinder Collar - 5, 6, 7 pin (4700 Escutcheon Trim)	DBZ	19.10	31793	
2-647-0015 7/8" Cylinder Collar - 5, 6, 7 pin (4700 Escutcheon Trim)	US32D	19.10	31789	
Note: For use with 1-1/8" mortise cylinders Note: All cylinder collars come with wave washer and spacer				

1. Items with the price in **bold and red** are Quick Ship items and ship in 24 hours.
Please use stock number when ordering. 2. U/M is each unless otherwise noted.



H **HAGER**[®]
COMPANIES

TABLE OF CONTENTS

A

Armor Fronts (Mortise) 52-53

B

Backset Extension Links

2500.....9

3400..... 25

3500..... 33

Blocking Rings..... 65

C

Cams (Fixed Cylinder).....59-60

Cams (LFIC) 65

Cams (SFIC).....62-63

Cash Box Nut..... 66

Cores

Small Format Interchangeable..... 60

Large Format Interchangeable 63

Cylinders

Key-In-Lever 57

Mortise (Fixed Cylinder) 59

Mortise (LFIC)..... 64

Mortise (SFIC)..... 62

Mortise Dummy..... 59

Mortise ADA Turn Knob..... 59

Rim (Fixed Cylinder) 58

Rim (LFIC)..... 64

Rim (SFIC) 62

Rim Dummy 58

Cylinder Aligning Sleeves..... 10, 26, 29, 35, 38

Cylinder Collars..... 51, 66-67

Cylindrical Locks

2500, Grade 2.....8-11

3400, Grade 1.....22-27

3500, Grade 2.....30-35

D

Deadbolts

3100, Grade 1..... 13

3200, Grade 2..... 17

3700, Interconnected 40

Deadlocks

3100, Grade 1.....12-15

3200, Grade 2.....16-19

Dustbox (ASA) 11, 26, 29, 35, 38, 52

Dustbox (Deadbolt)..... 13,17, 41

Decorative Locks

2300..... 5-7

E

Electric Options

Cylindrical Locks 24

Mortise Locks 47

Electric Standalone Locks

34K128-29

34K2.....28-29

F

Faceplate Adapter6, 9, 17, 33, 38, 40

I

Interchangeable Cores (Small Format) 60

Interchangeable Cores (Large Format) 63

Interconnected Locks

3700, Grade 239-41

K

Key Blanks (Fixed Cylinder)56-57

Key Blanks (SFIC)..... 61

Key Blanks (LFIC)..... 63

Keying Charges (Fixed Cylinder) 56

Keying Charges (SFIC)..... 61

Keying Charges (LFIC)..... 63

Keying, Tools and Accessories.....67-68

Keys, Cut (Fixed Cylinder)56-57

Keys, Cut (SFIC)..... 61

Keys, Cut (LFIC).....63-64

L

Latchbolts

2300, Tubular6

2500, Grade 2 Cylindrical9-10

3400, Grade 1 Cylindrical24-25

34K1/K2, Grade 1 Standalone..... 29

3500, Grade 2 Cylindrical32-33

3600, Grade 2 Tubular 37

3700, Grade 2 Interconnected 40

Lead Lining22, 30, 43, 45

Lead Times 3



Locks

M

Mortise Cam Screws	65-66
Mortise Cylinder	58-59, 62, 64

Mortise Locks

Mortise Locks (Deadlocks).....	48
Mortise Locks (Small Case Deadlocks)	49
Mortise Locks (Sectional).....	43-44
Mortise Locks (Escutcheon).....	45-46
Mortise Locks (Sliding Door)	50
Mortise Lock Accessories.....	51-55

P

Power Supplies

Cylindrical Lock.....	24
Mortise Lock.....	47

R

Rim Cylinder.....	58 62, 64
-------------------	-----------

S

Software

34K1.....	29
34K2.....	29

Screw Packs

2300, Tubular	7
2500, Grade 1 Deadlock.....	10
3100, Grade 2 Cylindrical	14
3200, Grade 2 Deadlock	18
3400, Grade 1 Cylindrical	27
34K1/K2, Grade 1 Standalone.....	29
3500, Grade 2 Cylindrical	35
3600, Grade 2 Tubular	38
3700, Grade 2 Interconnected	41
3800, Grade 1 Mortise.....	53-54
Stock Numbers	72-88

Strikes

2300, Tubular	6
2500, Grade 1 Deadlock.....	10
3100, Grade 1 Deadlock.....	13
3200, Grade 2 Deadlock.....	17
3300, Grade 3 Tubular.....	21
3400, Grade 1 Cylindrical	26
34K1/K2, Grade 1 Standalone.....	29
3500, Grade 2 Cylindrical	34
3600, Grade 2 Tubular	38
3700, Grade 2 Interconnected	41
3800, Grade 1 Mortise.....	50-52

T

Tactile Warning	22, 28, 30, 43, 45
Tailpieces (Fixed Cylinder)	57-58
Tailpieces (LFIC).....	64
Tailpieces (SFIC).....	61-62
Tailpieces (Rim Cylinder).....	59, 64
Thumbturns (Mortise Lock).....	53
Thru-bolt Jigs.....	11, 27, 35
Tubular Locks	
2300.....	5-7
3300, Grade 3.....	20-21
3600, Grade 2.....	36-38

INTRODUCTION

Hager Companies offers a variety of locks to meet a wide range of applications and solutions. Heavy Duty Grade 1 deadlocks, cylindrical locks, and mortise locks are ideal for schools, hospitals, and other high-use environments. Grade 2 deadlocks and cylindrical locks are ideal for less abusive environments, while Grade 2 tubular locks are suitable for heavy duty residential or medium duty commercial environments.

All Hager locks have been rigorously tested and certified to the highest standards. Most lock series are BHMA certified per the ANSI A156.2 standards. They are also UL/cUL Listed for all functions up to and including 3 hours for “A” labeled doors. In addition to the certifications, all Hager leversets are ADA compliant and most come with a lifetime warranty.

Most Hager locksets are either non-handed or field reversible in the case of the 3800 Series mortise lock. Conventional cylinder and small format interchangeable core are available on keyed functions. Most lock series offer three lever style options. Please check appropriate section for series specific options.

QUICK SHIP

Products denoted with **red and bold** in the stock number listing in the back of the pricing section are available to order through the QuickShip program and ship within 24 hours. When ordering these products please visit www.hagerco.com and log in to MyHager to access the ‘Quick Ship’ portal. Due to the promptness of the fulfillment process, Quick Ship orders are non-cancellable.

LEAD TIMES

Stock items will typically ship in five working days or less from the order entry date. Made-to-order items will typically ship in 15 working days depending on seasonal volume and order complexity. Special orders including industrials, special machining, and large quantities may need to be scheduled. The anticipated ship date will be included with each order acknowledgement. Please contact Customer Service if product availability is in question.

Smaller keyed lock orders will typically ship within 15 working days from the order entry date. All appropriate information and paperwork must be supplied for Hager to schedule and acknowledge master keyed lead times.

CANCELLATION NOTIFICATION

Cancellation for made-to-order items must be communicated within 48 hours of order placement.



3453 2³/₄" US26D US26 WTN SCC KD ASA TW

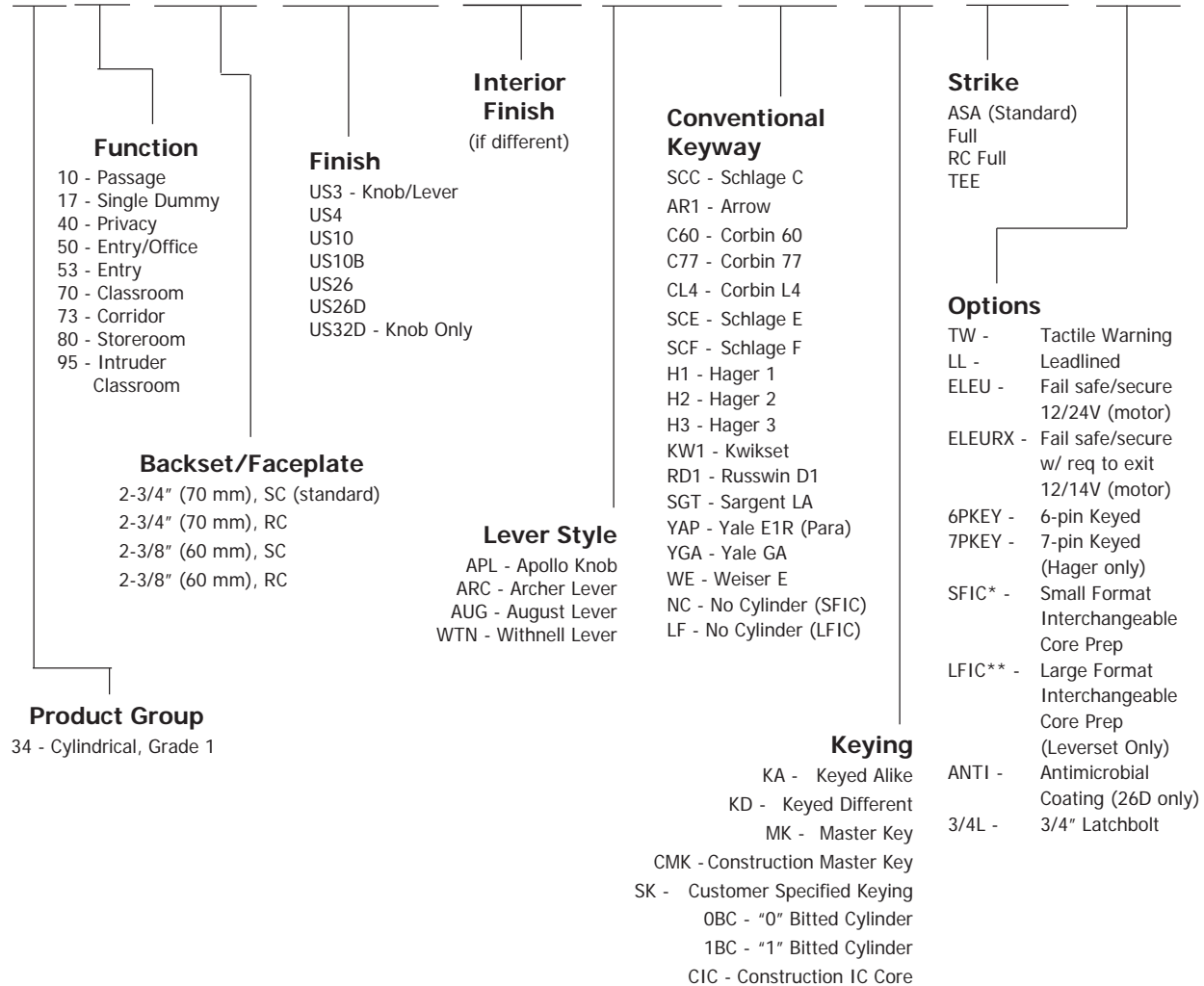

Notes:

- If master-keyed, include master key instruction sheet with order (available online).
- For additional keying information, please refer to cylinder, core, and keying section of catalog.
- Quick Connect option available on 3400 series electrified models (EL, EU, RX). **Ordering example: 3480 2-3/4" US26D WTN SCC KD ASA ELEUQC.**
- Interchangeable construction core will be included with the lockset if "CIC" is specified in keying section. Customer must specify BLUE or RED color for SFIC.

* Small format interchangeable core sold separately. Available in Best Keyways or Hager Keyways, A Standard. **Ordering example: 3453 2-3/4" US26D WTN NC ASA SFIC.**

Please refer to our Catalog or website (www.hagerco.com) for more detailed and series specific ordering information along with additional information including functions available, additional options, and keying information. Ordering forms such as Master Keying Instruction Sheet and Cylinder Instructions and Ordering Guide are also available on our website (www.hagerco.com).

Description

2300 Series
 Decorative Tubular Locks
 2-3/8" (60 mm) backset (optional)
 2-3/4" (70 mm) backset (standard)
 2-1/4" x 1" (57 mm x 25 mm) SC and RC Faceplate (standard)
 Round and square corner full lip strikes (standard)
 Optional strikes available. For ASA strike, add \$7.00 adder to list price of the lock.

Refer to catalog or website for more detailed information on functions.

Finishes other than US10B, US15, and US26D, are subject to extended lead-times. Consult customer service for availability.

When ordering handed lever designs, LH=LHR and RH=RHR

Split finish available at extended lead time. Handing information required when ordering split finish.



Charles 



Johnston 



Joshua 



Louis 



Warren 

Function	Finish	2021 List	Case Qty.
2310 Passage	US3	108.90	24
	US10B	108.90	
	US15	104.65	
	US26	108.90	
	US26D	104.65	
2317 Single Dummy (Specify handing on Johnston and Warren Levers)	US3	48.95	24
	US10B	48.95	
	US15	47.10	
	US26	48.95	
	US26D	47.10	

Function	Finish	2021 List	Case Qty.
2327 Double Dummy	US3	97.85	24
	US10B	97.85	
	US15	94.10	
	US26	97.85	
	US26D	94.10	
2340 Privacy	US3	115.90	24
	US10B	115.90	
	US15	111.40	
	US26	115.90	
	US26D	111.40	



Locks - 2300 Series



Latchbolts	Finish	2021 List	Box Qty.
Description			
2-639-7607 Passage Spring Latch - (2300) 2-3/4" (70 mm) backset	n/a	20.10	10
2-639-7609 Passage Spring Latch - (2300) 2-3/8" (60 mm) backset	n/a	20.10	10
2-639-7608 Privacy Latch - (2300) 2-3/4" (70 mm) backset	n/a	20.10	10
2-639-7610 Privacy Latch - (2300) 2-3/8" (60 mm) backset	n/a	20.10	10



Strikes	Finish	2021 List	Box Qty.
Description			
3933 T-Strike with Plastic Dust Box 1-1/8" x 2-3/4" (29 mm x 70 mm), square corner	US3 US10B US15 US26 US26D	8.10 8.10 8.10 8.10 8.10	10
2-639-7617 Full lip replacement strikes (2300) (Includes square and round corner)	US3	12.10	10
2-639-7619 Full lip replacement strikes (2300) (Includes square and round corner)	US10B	12.10	10
2-639-7620 Full lip replacement strikes (2300) (Includes square and round corner)	US15	12.10	10
2-639-7621 Full lip replacement strikes (2300) (Includes square and round corner)	US26	12.10	10
2-639-7622 Full lip replacement strikes (2300) (Includes square and round corner)	US26D	12.10	10



3935 ASA Strike 1-1/4" x 4-7/8" (32 mm x 124 mm), square corner	US3 US10B US15 US26 US26D	12.25 12.25 12.25 12.25 12.25	10
--	---------------------------------------	---	----



3959 Faceplate Adapter Converts 1" (25 mm) to 1/8" (29 mm) width	NF	2.65	10
---	----	------	----





Components and Screwpacks		Finish	2021 List	Box Qty.
2-639-7601	Privacy Accessory Kit	US3	8.50	10
2-639-7603	Privacy Accessory Kit	US10B	8.50	10
2-639-7604	Privacy Accessory Kit	US15	8.50	10
2-639-7605	Privacy Accessory Kit	US26	8.50	10
2-639-7606	Privacy Accessory Kit	US26D	8.50	10
2-300-0091	Replacement Screw Packs	US3	10.50	10
2-300-0092	Replacement Screw Packs	US10B	10.50	10
2-300-0093	Replacement Screw Packs	US15/26/26D	10.50	10

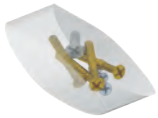

Locks - 2500 Series



Archer  



Withnell  

Description

2500 Series

Grade 2 Cylindrical - Economy
 Fixed Cylinder, Standard
 6 Pin Cylinders, 5-pin Keyed
 Schlage C Keyway - KD Standard
 2-3/4" (70 mm) Backset
 2-1/4" x 1-1/8" (57 mm x 29 mm) SC Faceplate
 ASA Strike

Small Format Interchangeable Core option Available (cores sold separately - refer to Keying/Core section).

Optional backsets, faceplates and strikes available.

Optional keying/keyways available.

Refer to catalog or website for more detailed information on functions.

If construction SFIC core is included with the lockset, \$51.20 will be added to the list price of the lock. Refer to keying/cores section for construction core options.

Function	Finish	2021 List	Case Qty.
2510 (F75) Passage	US3	100.05	6
	US10B	100.05	
	US26D	100.05	
2517 Single Dummy	US3	60.05	12
	US10B	60.05	
	US26D	60.05	
2525 (F111) Exit	US3	90.10	6
	US10B	90.10	
	US26D	90.10	
2527 Double Dummy	US3	117.80	6
	US10B	117.80	
	US26D	117.80	

Function	Finish	2021 List	Case Qty.
2540 (F76A) Privacy	US3	102.20	6
	US10B	102.20	
	US26D	102.20	
2550 (F82A) Office	US3	114.00	6
	US10B	114.00	
2553 (F109) Entry	US26D	114.00	
2570 (F84) Classroom	US3		
	US10B		
2580 (F86) Storeroom	US26D		



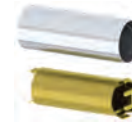
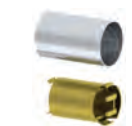

Latchbolts Description	Finish	2021 List	Box Qty.
3947 Spring Latch - Passage Only (2510) 2-3/4" (70 mm) Backset 2-1/4" x 1-1/8" (57 mm x 29 mm) Faceplate Must specify square or round corner.	US3 US10B US26D	32.20 32.20 32.20	10
3949 Spring Latch - Passage Only (2510) 2-3/8" (60 mm) Backset 2-1/4" x 1" (57 mm x 25 mm) Faceplate Must specify square or round corner.	US3 US10B US26D	32.20 32.20 32.20	10
3965 Spring Latch - Privacy Only (2540) 2-3/4" (70 mm) Backset 2-1/4" x 1-1/8" (57 mm x 29 mm) Faceplate Must specify square or round corner.	US3 US10B US26D	32.20 32.20 32.20	10
3967 Spring Latch - Privacy Only (2540) 2-3/8" (60 mm) Backset 2-1/4" x 1" (57 mm x 25 mm) Faceplate Must specify square or round corner.	US3 US10B US26D	32.20 32.20 32.20	10
3948 Dead Latch - 2525 and all keyed functions (2500 Series) 2-3/4" (70 mm) Backset 2-1/4" x 1-1/8" (57 mm x 29 mm) Faceplate Must specify square or round corner.	US3 US10B US26D	32.20 32.20 32.20	10
3950 Dead Latch - 2525 and all keyed functions (2500 Series) 2-3/8" (60 mm) Backset 2-1/4" x 1" (57 mm x 25 mm) Faceplate Must specify square or round corner.	US3 US10B US26D	32.20 32.20 32.20	10
3959 Faceplate Adapter Can be used with 2500 2-3/8" (60 mm) backset latchbolt. Converts 1" (25 mm) to 1-1/8" (29 mm) width.	NF	2.65	10
3917 3-3/4" (95 mm) Backset Extension Link Must be used with 2-3/8" (60 mm) backset latchbolt to achieve 3-3/4" total backset.	NF	21.30	
3937 5" (127) Backset Extension Link Must be used with 2-3/4" (70 mm) backset latchbolt to achieve 5" total backset.	NF	23.00	
Drive-In Latchbolts Description	Finish	2021 List	Box Qty.
3922 2-3/4" (70 mm) Drive-In Spring Latch - Passage only (2510)	NF	32.20	20
3923 2-3/4" (70 mm) Drive-In Spring Latch - Privacy only (2540)	NF	32.20	20
3925 2-3/8" (60 mm) Drive-In Spring Latch - Passage only (2510)	NF	32.20	20



Locks - 2500 Series

Drive-In Latchbolts			
Description	Finish	2021 List	Box Qty.
3926 2-3/8" (60 mm) Drive-In Spring Latch - Privacy only (2540)	NF	32.20	20
3924 2-3/4" (70 mm) Drive-In Dead Latch - All keyed functions (2500 Series)	NF	32.20	20
3927 2-3/8" (60 mm) Drive-In Dead Latch - All keyed functions (2500 Series)	NF	32.20	20
Strikes			
Description	Finish	2021 List	Box Qty.
3933 T-Strike with Plastic Dust Box 1-1/8" x 2-3/4" (29 mm x 70 mm), square corner	US3	8.10	10
	US10B	8.10	
	US26D	8.10	
3934 Full Lip Strike 1-5/8" x 2-1/4" (41 mm x 57 mm), square corner	US3	8.10	10
	US10B	8.10	
	US26D	8.10	
3935 ASA Strike Plate Shipped standard with 2500 Series 1-1/4" x 4-7/8" (32 mm x 124 mm), square corner 1-5/16" lip Order dust box separately	US3	12.25	10
	US10B	12.25	
	US26D	12.25	
3958 Round Corner Full Lip Strike 1-5/8" x 2-1/4" (41 mm x 57 mm), round corner (1/4" radius)	US3	8.10	10
	US10B	8.10	
	US26D	8.10	
Components and Screwpacks			
Description	Finish	2021 List	
2-639-3577 Cylinder Aligning Sleeve (10 pack)	NF	3.05	
2-300-0048 Screwpack - 2500 Series Lever Locksets	US3	12.15	
2-300-0050 Screwpack - 2500 Series Lever Locksets	US10B	12.15	
2-300-0052 Screwpack - 2500 Series Lever Locksets	US26D	12.15	
2-300-0058 Screwpack - 2517/2527 Lever Locksets only	NF	12.15	
2-639-3523 2500 Series Thru Bolt Posts	NF	4.00	

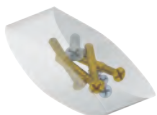
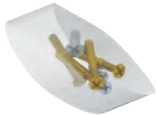



Components and Screwpacks			
Description	Finish	2021 List	
2-669-0389 ASA Metal Dust Box	NF	6.60	
3911 2500 Series Leverset Thru-Post Drill Jig	NF	18.75	ea



Locks - 3100 Series

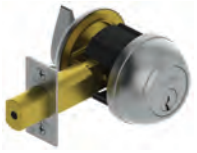

Description

3100 Series

Grade 1
 Fixed Cylinder Standard
 6 Pin Cylinders, 5-pin Keyed
 Schlage C Keyway - KD Standard
 2-3/4" (70 mm) Backset
 2-1/4" x 1-1/8" (57 mm x 29 mm) Square Corner Faceplate
 Square Corner Strike

Small Format Interchangeable Core option available (cores sold separately - refer to Keying/Core section).
 Optional backsets, faceplates, and strikes available (see below).
 ASA Strike Available. Add \$7.00 to list price of deadlock.
 Optional keying/keyways available.
 Refer to catalog or website for more detailed information on functions.

Function	Finish	2021 List	Case Qty.
3114 (E2141) Double Cylinder	US3	191.70	12
	US4	191.70	
	US10	191.70	
	US10B	191.70	
	US26	191.70	
	US26D	184.35	
3115 (E2151) Cylinder x Thumbturn	US3	169.05	12
	US4	169.05	
	US10	169.05	
	US10B	169.05	
	US26	169.05	
	US26D	162.55	

Function	Finish	2021 List	Case Qty.
3118 (E2171) Classroom	US3	174.90	12
	US4	174.90	
	US10	174.90	
	US10B	174.90	
	US26	174.90	
	US26D	168.15	





Deadbolts		Finish	2021 List	Box Qty.
Description				
3940	2-3/4" (70 mm) Backset - Standard	US3	32.20	10
	2-1/4" x 1-1/8" (57 mm x 29 mm) Faceplate	US4	34.30	
	Must Specify Square or Round Corner	US10	34.30	
		US10B	32.20	
		US26D	32.20	
3941	2-3/8" (60 mm) Backset	US3	32.20	10
	2-1/4"x 1" (57 mm x 25 mm) Faceplate	US4	34.30	
	Must specify square or round corner	US10	34.30	
		US10B	32.20	
		US26D	32.20	
Strikes		Finish	2021 List	Box Qty.
Description				
3929	ASA Deadlock Strike	US3	19.70	10
	1-1/4" x 4-7/8" (32 mm x 124 mm), Square Corner	US4	20.95	
	1 5/16" lip	US10	20.95	
	Order dust box separately.	US10B	19.70	
		US26	19.70	
		US26D	19.70	
3930	Strike with plastic dust box	US3	8.00	10
	1-1/8" x 2-3/4" (29 mm x 70 mm), Square corner	US4	8.45	
		US10	8.45	
		US10B	8.00	
		US26D	8.00	
2-639-3109	Deadlock Dust Box	NF	3.85	10
Components and Screwpacks		Finish	2021 List	
Description				
2-639-3151	Collar Handing Keys - 3118 - (RH and LH w/ set screw)	NF	6.40	
2-639-7146	Thumbturn Repair Kit - 3100 Series	US3	11.60	
2-639-7147	Thumbturn Repair Kit - 3100 Series	US4	11.60	
2-639-7148	Thumbturn Repair Kit - 3100 Series	US10	11.60	
2-639-7149	Thumbturn Repair Kit - 3100 Series	US10B	11.60	
2-639-7150	Thumbturn Repair Kit - 3100 Series	US26	11.60	
2-639-3168	Thumbturn Repair Kit - 3100 Series	US26D	11.60	

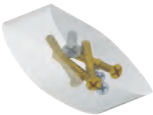
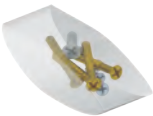

Locks - 3100 Series

Components and Screwpacks

Description	Finish	2021 List
 2-639-3152 Thumbturn Rose - 3100 Series	US3	9.30
2-639-3153 Thumbturn Rose - 3100 Series	US4	9.30
2-639-3154 Thumbturn Rose - 3100 Series	US10	9.30
2-639-3155 Thumbturn Rose - 3100 Series	US10B	9.30
2-639-3156 Thumbturn Rose - 3100 Series	US26	9.30
2-639-3157 Thumbturn Rose - 3100 Series	US26D	9.30
 2-300-0000 Screwpack 3115/3118	US3/US10	11.15
2-300-0001 Screwpack 3115/3118	US4	11.15
2-300-0003 Screwpack 3115/3118	US10B	11.15
2-300-0004 Screwpack 3115/3118	US26	11.15
2-300-0005 Screwpack 3115/3118	US26D	11.15
 2-300-0006 Screwpack 3114	US3/US10	11.15
2-300-0007 Screwpack 3114	US4	11.15
2-300-0009 Screwpack 3114	US10B	11.15
2-300-0010 Screwpack 3114	US26	11.15
2-300-0011 Screwpack 3114	US26D	11.15
 2-639-3167 Tailpiece Kit for 2" - 2-1/4" Thick Door (3115/3118 Fixed Cylinder Only)		8.60
 2-639-3236 Tailpiece Kit for 2" - 2-1/4" Thick Door (3114 Fixed Cylinder Only)	US3/US4/ US10	8.60
2-639-3238 Tailpiece Kit for 2" - 2-1/4" Thick Door (3114 Fixed Cylinder Only)	US10B	8.60
2-639-3239 Tailpiece Kit for 2" - 2-1/4" Thick Door (3114 Fixed Cylinder Only)	US26/US26D	8.60





Components and Screwpacks		
Description	Finish	2021 List
2-639-7164 SFIC Deadlock Cylinder Assembly - 3115/3118	US3	20.00
2-639-7167 SFIC Deadlock Cylinder Assembly - 3115/3118	US4	20.00
2-639-7160 SFIC Deadlock Cylinder Assembly - 3115/3118	US10	20.00
2-639-7161 SFIC Deadlock Cylinder Assembly - 3115/3118	US10B	20.00
2-639-7163 SFIC Deadlock Cylinder Assembly - 3115/3118	US26D	20.00



Locks - 3200 Series



Description

3200 Series

Grade 2
 Fixed Cylinder, Standard
 6 Pin Cylinders, 5-pin Keyed
 Schlage C Keyway - KD Standard
 2-3/4" (70 mm) Backset
 2-1/4" x 1-1/8" SC Faceplate
 (57 mm x 29 mm)
 Square Corner Strike

Small Format Interchangeable Core option available (cores sold separately - refer to Keying/Core section).

If construction SFIC core is included with the lockset, \$51.20 will be added to list price of the lock. Refer to keying/cores section for construction core options.

Refer to Catalog or website for more detailed information on functions.

Optional backsets, faceplates, and strikes available (see next page).

ASA Strike Available. Add \$7.00 to list price of deadlock.

Optional keying/keyways available.

Function	Finish	2021 List	Case Qty.
3214 (E2142) Double Cylinder	US3	111.90	12
	US4	111.90	
	US10	111.90	
	US10B	111.90	
	US26D	106.60	
	US32D	97.75	
3215 (E2152) Cylinder x Thumbturn	US3	91.15	12
	US4	91.15	
	US10	91.15	
	US10B	91.15	
	US26D	86.80	
	US32D	79.65	
3216 Thumbturn x Occupancy Indicator	US3	72.50	12
	US4	72.50	
	US10	72.50	
	US10B	72.50	
	US26D	69.05	
	US32D	63.30	

Function	Finish	2021 List	Case Qty.
3220 (E21112) Thumbturn only w/ Blank Plate	US3	67.75	12
	US4	67.75	
	US10	67.75	
	US10B	67.75	
	US26D	64.50	
	US32D	59.20	
3221 (E2192) Thumbturn only (Replaced 3219)	US3	55.70	12
	US4	55.70	
	US10	55.70	
	US10B	55.70	
	US26D	53.05	
	US32D	48.70	
3222 Retrofit Kit for use w/ 3220 or 3221	US3	36.25	12
	US4	36.25	
	US10	36.25	
	US10B	36.25	
	US26D	34.55	
	US32D	31.70	



Deadbolts Description	Finish	2021 List	Box Qty.
3940	US3	32.20	10
2-3/4" (70 mm) Backset - Standard	US4	34.30	
2-1/4" x 1-1/8" (57 mm x 29 mm) Faceplate	US10	34.30	
Must Specify Square or Round Corner	US10B	32.20	
US32D available in square corner only	US26D	32.20	
	US32D	32.20	



3941	US3	32.20	10
2-3/8" (60 mm) Backset	US4	34.30	
2-1/4"x 1" (57 mm x 25 mm) Faceplate	US10	34.30	
Must specify square or round corner	US10B	32.20	
US32D available in square corner only	US26D	32.20	
	US32D	32.20	

3942	US3	32.20	10
2-3/8" - 2-3/4" (60 mm - 70 mm) Adjustable	US4	34.30	
2-1/4" x 1-1/8" (57 mm x 29 mm) Square Corner Faceplate	US10	34.30	
For use with 3220, 3221 deadlocks only	US10B	32.20	
Round corner optional	US26D	32.20	
1" Wide faceplate available in square corner or round corner	US32D	32.20	
US32D available in square corner only			



3959	NF	2.65	10
Faceplate Adapter			
Can be used with 3220 and 3221 deadlock			
Converts 1" (25 mm) to 1-1/8" (29 mm) width			



Strikes Description	Finish	2021 List	Box Qty.
3929	US3	19.70	10
ASA Deadlock Strike	US4	20.95	
1-1/4" x 4-7/8" (32 mm x 124 mm), Square Corner	US10	20.95	
1-5/16" lip	US10B	19.70	
Optional Strike can be used with 3100/3200 Series.	US26	19.70	
Order dust box separately.	US26D/US32D	19.70	
For use with 3200 Series US32D, order US26/US26D.			











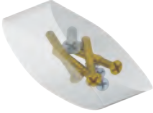
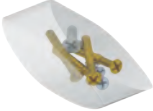
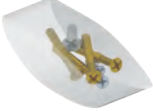

3930	US3	8.00	10
Strike with plastic dust box	US4	8.45	
1-1/8" x 2-3/4" (29 mm x 70 mm), Square corner	US10	8.45	
	US10B	8.00	
	US26D	8.00	
	US32D	8.00	







2-639-3109	NF	3.85	10
Deadlock Dust Box			
For use with standard strike, 3930.			



Locks - 3200 Series

Components and Screwpacks		Finish	2021 List
Description			
 2-300-0018 Screwpack for 3214		US3/US10	11.15
 2-300-0019 Screwpack for 3214		US4	11.15
 2-300-0021 Screwpack for 3214		US10B	11.15
 2-300-0023 Screwpack for 3214		US26D/US32D	11.15
 2-300-0024 Screwpack for 3215		US3/US10	11.15
 2-300-0025 Screwpack for 3215		US4	11.15
 2-300-0027 Screwpack for 3215		US10B	11.15
 2-300-0029 Screwpack for 3215		US26D/US32D	11.15
2-300-0105 Screwpack 3216/3220/3222		US3/US10	11.15
2-300-0106 Screwpack 3216/3220/3222		US4	11.15
2-300-0108 Screwpack 3216/3220/3222		US10B	11.15
2-300-0110 Screwpack 3216/3220/3222		US26D/US32D	11.15
2-300-0111 Screwpack 3221		US3/US10	11.15
2-300-0112 Screwpack 3221		US4	11.15
2-300-0114 Screwpack 3221		US10B	11.15
2-300-0116 Screwpack 3221		US26D/US32D	11.15
2-639-3218 Thumbturn Assembly - 3215		US3/US10	11.40
 2-639-3219 Thumbturn Assembly - 3215		US4	11.40
 2-639-3221 Thumbturn Assembly - 3215		US10B	11.40
 2-639-7153 Thumbturn Assembly - 3215		US26D	11.40
 2-639-3223 Thumbturn Assembly - 3215		US32D	11.40



Components and Screwpacks		Finish	2021 List
Description			
	2-639-3230 Tailpiece Kit for 2" - 2-1/4" Door (3215 Fixed Cylinder Only)	US3/US10	8.60
	2-639-3231 Tailpiece Kit for 2" - 2-1/4" Door (3215 Fixed Cylinder Only)	US4	8.60
	2-639-3233 Tailpiece Kit for 2" - 2-1/4" Door (3215 Fixed Cylinder Only)	US10B	8.60
	2-639-3235 Tailpiece Kit for 2" - 2-1/4" Door (3215 Fixed Cylinder Only)	US26D	8.60
	2-639-7151 Tailpiece Kit for 2" - 2-1/4" Door (3215 Fixed Cylinder Only)	US32D	8.60
	2-639-3236 Tailpiece Kit for 2" - 2-1/4" Door (3214 Fixed Cylinder Only)	US3/US4/ US10	8.60
	2-639-3238 Tailpiece Kit for 2" - 2-1/4" Door (3214 Fixed Cylinder Only)	US10B	8.60
	2-639-3239 Tailpiece Kit for 2" - 2-1/4" Door (3214 Fixed Cylinder Only)	US26D	8.60
	2-639-7157 3215 SFIC Deadlock Spacer	US3	6.85
	2-639-7158 3215 SFIC Deadlock Spacer	US4	6.85
	2-639-7154 3215 SFIC Deadlock Spacer	US10	6.85
	2-639-7155 3215 SFIC Deadlock Spacer	US10B	6.85
	2-639-7156 3215 SFIC Deadlock Spacer	US26D	6.85
	2-639-7144 3215 SFIC Deadlock Spacer	US32D	6.85
	2-639-7164 SFIC Deadlock Cylinder Assembly - 3215	US3	20.00
	2-639-7167 SFIC Deadlock Cylinder Assembly - 3215	US4	20.00
	2-639-7160 SFIC Deadlock Cylinder Assembly - 3215	US10	20.00
	2-639-7161 SFIC Deadlock Cylinder Assembly - 3215	US10B	20.00
	2-639-7163 SFIC Deadlock Cylinder Assembly - 3215	US26D	20.00
	2-639-7166 SFIC Deadlock Cylinder Assembly - 3215	US32D	20.00
	2-639-7641 3216 Emergency Key (10Pk)	NF	8.70
			



Locks - 3300 Series



3300 Series

Grade 3 Tubular - Residential
 Fixed Cylinder, Standard
 5 Pin Keyed Different Cylinder only - no keying services available
 Schlage C Keyway only
 2-3/8" - 2-3/4" (60mm - 70mm) adjustable backset
 2-1/4" - 1" (57mm x 25mm) RC Faceplate (Square corner faceplate loose in the box)
 1-3/4" x 2-1/4" Full lip round corner strike, no box (standard)

Optional strikes must be purchased separately.
 Refer to catalog or website for more detailed information on functions.
 Finishes other than US26D will be subject to extended lead times. Consult customer service for availability.
 When ordering handed lever designs, LH=LHR and RH=RHR.



Archer



August



Johnston



Withnell

Function	Finish	2021 List	Case Qty.
3310	US3	\$47.90	18
Passage	US10B	\$55.65	18
	US15	\$46.90	18
	US26	\$50.50	18
	US26D	\$50.50	18
3317	US3	\$22.95	27
Single Dummy (Specify Handing for Johnston lever)	US10B	\$26.80	27
	US15	\$22.95	27
	US26	\$24.75	27
	US26D	\$24.75	27

Function	Finish	2021 List	Case Qty.
3340	US3	\$50.50	18
Privacy	US10B	\$58.20	18
	US15	\$50.50	18
	US26	\$53.05	18
	US26D	\$53.05	18
3353	US3	\$59.25	18
Entry	US10B	\$66.95	18
	US15	\$59.25	18
	US26	\$61.80	18
	US26D	\$61.80	18





Strikes Description	Finish	2021 List
2-639-7790 Full Lip Strike 1-3/4" x 2-1/4" (45mm x 57mm), square corner	US3	\$2.10
2-639-7792 Full Lip Strike	US10B	\$2.10
2-639-7793 Full Lip Strike	US15/US26/US26D	\$2.10
2-639-7795 T-Strike 1-1/8" x 2-3/4" (29mm x 70mm), square corner	US3	\$2.10
2-639-7797 T-Strike	US10B	\$2.10
2-639-7798 T-Strike	US15/US26/US26D	\$2.10



Locks - 3400 Series

Description

3400 Series

Grade 1 Cylindrical
 Fixed Cylinder, Standard
 6 Pin Cylinders, 5-pin Keyed
 Schlage C Keyway - KD Standard
 2-3/4" (70 mm) Backset
 2-1/4" x 1-1/8" SC Faceplate (57 mm x 29 mm)
 ASA Strike

Small and Large Format Interchangeable Core option available (cores sold separately - refer to Keying/Core section).

If construction core is included with the lockset, \$51.20 (SFIC) or \$64.75 (LFIC) will be added to the list price of the lock. Refer to keying/cores section for construction core options.

Extended Lip ASA strike available. Add \$12.00 to list price of the lock.

Lead Lined available. Add \$150.00 to the list price of the lock.

Tactile Warning available on levers only. Add \$42.00 to the list price of lock.

Anti-microbial available on 26D finish only. Add \$50.00 to the list price of the lock.

3/4" latchbolt available. Add \$118.00 to the list price of lock.

Split finish available. Priced at higher finish.

Optional backsets, faceplates, and strikes available (see next page).

Security Torx screws available. Add \$14.00 to list price of the lock.

Optional keying/keyways available.

3495 Intruder Classroom includes locking indicator rose.

Refer to catalog or website for more detailed information on functions.



Archer   



August   



Withnell   

Function	Finish	Lever 2021 List	Case Qty.
3410 (F75) Passage	US3	297.50	6
	US4	297.50	
	US10	297.50	
	US10B	297.50	
	US26	297.50	
	US26D	286.05	
3417 Single Dummy	US3	139.95	12
	US4	139.95	
	US10	139.95	
	US10B	139.95	
	US26	139.95	
	US26D	134.55	
3440 (F76A) Privacy	US3	342.60	6
	US4	342.60	
	US10	342.60	
	US10B	342.60	
	US26	342.60	
	US26D	329.40	



Description

3400 Series (Continued)
Continued

Function	Finish	Lever 2021 List	Case Qty.
3450 (F82A) Office	US3	398.95	6
	US4	398.95	
3453 (F109) Entry	US10	398.95	
	US10B	398.95	
3470 (F84) Classroom	US26	398.95	
	US26D	383.65	
3473 (F90) Corridor			
3480 (F86) Storeroom			
3482 (F87) Institution	US3	518.45	6
	US4	518.45	
	US10	518.45	
	US10B	518.45	
	US26	518.45	
	US26D	440.95	
3495 (F110) Intruder Classroom*	US3	486.15	6
	US4	486.15	
	US10	486.15	
	US10B	486.15	
	US26	486.15	
	US26D	467.50	



Locks - 3400 Series



3400 Series Electrified Cylindrical Lockset	Add electrified charges to the list price of the lock	
Description	Function	2021 List
Outside lever continuously locked (EL) or unlocked (EU) by 12 or 24V. Latchbolt retracted by key outside or lever inside. Auxiliary latch deadlocks latchbolt when door is closed. Inside always free for immediate egress.	ELEU 12V/24V Storeroom - Fail Safe/Fail Secure	220.50
Monitors inside lever rotation. Incorporates into fire alarm systems or in conjunction with an electromagnet.	RX Request to Exit	179.00

QUICK CONNECT OPTION: Locks will come with molex connector attached. Quick connect option allows rapid installation of locks when used with the Hager Quick Connect harness cable. See Commercial Hinges section (page 7) for available harness sizes.

QUICK CONNECT ORDERING EXAMPLE: 3480 US26D WTN ELEUQC



Power Supplies	Add electrified charges to the list price of the lock	
Description	Function	2021 List
Provides power for Fail Safe or Fail Secure locking devices and interface with building alarm controls, card readers, keypads, and other door controls.	2903 24 Volt Power Supply	Reference Electrified products section
Provides power and control for openings with an electrified locking device and automatic door operator.	2904 24 Volt Power Supply	Reference Electrified products section
Provides up to 1 amp of 12 or 24 Volt DC Power for all Hager Electrified Products.	2908 24 Volt Power Supply	Reference Electrified products section
Provides up to 2 amps of 12 or 24 Volt DC Power for all Hager Electrified Products.	2909 24 Volt Power Supply	Reference Electrified products section



Latchbolts	Finish	2021 List	Box Qty.
3943 Spring Latch - Passage Only (3410) 2-3/4" (70 mm) Backset 2-1/4" x 1-1/8" (57 mm x 29 mm) Faceplate *Must specify square or round corner.	US3 US4 US10 US10B US26 US26D	33.85 36.00 36.00 33.85 33.85 33.85	10
3945 Spring Latch - Passage Only (3410) 2-3/8" (60 mm) Backset 2-1/4" x 1-1/8" (57 mm x 29 mm) Faceplate *Must specify square or round corner.	US3 US4 US10 US10B US26 US26D	33.85 36.00 36.00 33.85 33.85 33.85	10
3964 Spring Latch - Privacy Only (3440) 2-3/4" (70 mm) Backset 2-1/4" x 1-1/8" (57 mm x 29 mm) Faceplate *Must specify square or round corner.	US3 US4 US10 US10B US26 US26D	33.85 36.00 36.00 33.85 33.85 33.85	10





Latchbolts Description	Finish	2021 List	Box Qty.
3966 Spring Latch - Privacy Only (3440) 2-3/8" (60 mm) Backset 2-1/4" x 1-1/8" (57 mm x 29 mm) Faceplate *Must specify square or round corner.	US3	33.85	10
	US4	36.00	
	US10	36.00	
	US10B	33.85	
	US26	33.85	
	US26D	33.85	
3944 Dead Latch - All keyed functions except Corridor 2-3/4" (70 mm) Backset 2-1/4" x 1-1/8" (57 mm x 29 mm) Faceplate *Must specify square or round corner.	US3	33.85	10
	US4	36.00	
	US10	36.00	
	US10B	33.85	
	US26	33.85	
	US26D	33.85	
3946 Dead Latch - All keyed functions except Corridor 2-3/8" (60 mm) Backset 2-1/4" x 1-1/8" (57 mm x 29 mm) Faceplate *Must specify square or round corner.	US3	33.85	10
	US4	36.00	
	US10	36.00	
	US10B	33.85	
	US26	33.85	
	US26D	33.85	
3992 Dead Latch - Corridor (3473) 2-3/8" (60 mm) Backset 2-1/4" x 1-1/8" (57 mm x 29 mm) Faceplate *Must specify square or round corner.	US3	33.85	10
	US4	36.00	
	US10	36.00	
	US10B	33.85	
	US26	33.85	
	US26D	33.85	
3993 Dead Latch - Corridor (3473) 2-3/4" (70 mm) Backset 2-1/4" x 1-1/8" (57 mm x 29 mm) Faceplate *Must specify square or round corner.	US3	33.85	10
	US4	36.00	
	US10	36.00	
	US10B	33.85	
	US26	33.85	
	US26D	33.85	
3932 3/4" Dead Latch (3450, 3453, 3470, 3480, 3495) 2-3/4" (70 mm) Backset 2-1/4" x 1-1/8" (57 mm x 29 mm) square corner faceplate	US3	118.35	10
	US4	118.35	
	US10	118.35	
	US10B	118.35	
	US26	118.35	
	US26D	118.35	
3916 3-3/4" (95 mm) Backset Extension Link Must be used with 2-3/8" backset latchbolt to achieve 3-3/4" total backset.	NF	21.30	10
3936 5" (127 mm) Backset Extension Link Must be used with 2-3/4" backset latchbolt to achieve 5" total backset.	NF	23.00	10



Locks - 3400 Series



Strikes		Finish	2021 List	Box Qty.
Description				
3933 T-Strike with Plastic Dust Box 1-1/8" x 2-3/4" (29 x 70 mm), square corner		US3	8.10	10
		US4	8.50	
		US10	8.50	
		US10B	8.10	
		US26	8.10	
		US26D	8.10	
3934 Full Lip Strike 1-5/8" x 2-1/4" (41 mm x 57 mm), square corner		US3	8.10	10
		US4	8.50	
		US10	8.50	
		US10B	8.10	
		US26	8.10	
		US26D	8.10	
3935 ASA Strike Shipped standard with 3400 Series 1-1/4" x 4-7/8" (32 mm x 124 mm), square corner 1-5/16" lip Order dust box separately		US3	12.25	10
		US4	12.25	
		US10	12.25	
		US15	12.25	
		US10B	12.25	
		US26	12.25	
3958 Round Corner Full Lip Strike 1-5/8" x 2-1/4" (41 mm x 57 mm), round corner (1/4" radius)		US3	8.10	10
		US4	8.50	
		US10	8.50	
		US10B	8.10	
		US26	8.10	
		US26D	8.10	
2-669-0389 ASA Metal Dust Box		NF	6.60	10
Components and Screwpacks		Finish	2021 List	
Description				
2-639-3490 Cylinder Aligning Sleeve (10 pack)		NF	3.25	



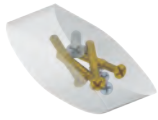
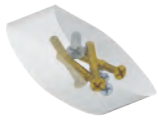

Components and Screwpacks		Finish	2021 List
Description			
2-300-0036 Screwpack - 3400 Series Lever Lockset		US3/US4/ US10	12.15
2-300-0039 Screwpack - 3400 Series Lever Lockset		US10B	12.15
2-300-0041 Screwpack - 3400 Series Lever Lockset		US26/US26D	12.15
2-300-0042 Screwpack - 3417 Dummy Lever Only		NF	5.15
3911 3400 Series Leverset Thru-Post Drill Jig		NF	18.75 ea



Locks - 34K Series

Description

34K Series

Grade 1 Cylindrical Standalone
 Fixed Cylinder, Standard
 6 Pin Cylinders, 5-pin keyed Standard
 Schlage C Keyway – KD Standard
 2-3/4" (70mm) Backset
 2-1/4" x 1-1/8" SC Faceplate (57mm x 29mm)
 ASA Strike Standard

Small Format Interchangeable Core option available (Core sold separately – refer to Keying/Core section).

If construction SFIC core is included with the lockset, \$51.20 will be added to list price of the lock. Refer to keying/cores section for construction core options.

Extended Lip ASA strike available. Add \$12.00 to list price of the lock.

Tactile Warning available. Add \$50.00 to the list price of lock.

3/4" latchbolt available. Add \$118.00 to the list price of lock.

Optional faceplates and strikes available

Optional keying/keyways available.



Archer



August



Withnell



Function	Finish	2021 List	Case Qty.
34K1	US10B	1114.50	2
Keypad - Entry/ Storeroom	US26D	1074.30	

Function	Finish	2021 List	Case Qty.
34K2	US10B	1596.50	2
Keypad + Prox - Entry/ Storeroom	US26D	1538.85	

34K SERIES LOCKS HOW TO ORDER

34K1 2-3/4" US26D WTN SCC KD ASA 6P KEY

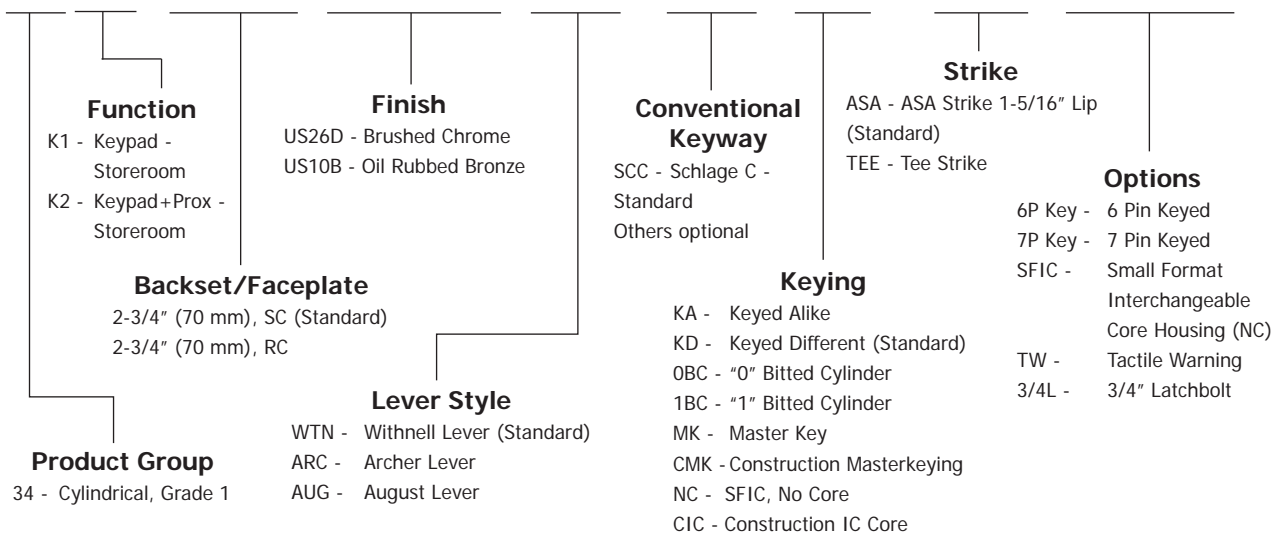

Audit Trail Accessories			
Description	Finish	2021 List	
2-639-6000 34K1 Software Kit – Includes Disc, USB Cable and Programming manual	n/a	130.00	
2-639-6001 34K2 Software Kit – Includes Disc, Prox card reader/enroller, USB Cable and Programming manual	n/a	460.00	
Latchbolts			
Description	Finish	2021 List	Box Qty.
3944 Dead Latch 2-3/4" (70 mm) Backset 2-1/4" x 1-1/8" (57 mm x 29 mm) Faceplate *Must specify square or round corner.	US10B US26D	32.20 32.20	10
3932 3/4" Dead Latch 2-3/4" (70 mm) Backset 2-1/4" x 1-1/8" (57 mm x 29 mm) square corner faceplate	US10B US26D	118.35 118.35	10
Strikes			
Description	Finish	2021 List	Box Qty.
3933 T-Strike with Plastic Dust Box 1-1/8" x 2-3/4" (29 mm x 70 mm), square corner	US10B US26D	8.10 8.10	10
3935 ASA Strike Plate Shipped standard 1-1/4" x 4-7/8" (32 mm x 124 mm), square corner 1-5/16" lip Order dust box separately:	US10B US26D	12.25 12.25	10
2-669-0389 ASA Metal Dust Box	NF	6.60	10
Components and Screwpacks			
Description	Finish	2021 List	
2-300-0300 Screwpack - 34K Series Lockset	US10B	13.25	
2-300-0301 Screwpack - 34K Series Lockset	US26D	13.25	
2-300-0302 Screwpack - 34K Battery Cover (10 pack)	NF	10.50	
2-639-3490 Cylinder Aligning Sleeve (10 pack)	NF	3.25	
2-639-7714 Thru-bolt Posts (2 pack)	NF	4.00	

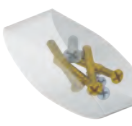

Locks - 3500 Series

Description

3500 Series

Grade 2 Cylindrical
 Fixed Cylinder, Standard
 6 Pin Cylinders, 5-pin Keyed
 Schlage C Keyway - KD Standard
 2-3/4" (70 mm) Backset
 2-1/4" x 1-1/8" (57 mm x 29 mm) SC Faceplate
 ASA Strike

Small Format Interchangeable Core option available (cores sold separately - refer to Keying/Core section).

If construction SFIC core is included with the lockset, \$51.20 will be added to list price of the lock. Refer to keying/cores section for construction core options.

Extended Lip ASA strike available. Add \$12.00 to list price of the lock.

Tactile Warning available (Levers only). Add \$50.00 to the list price of the lock.

Anti-microbial available on 26D finish only. Add \$40.00 to list

price of lock.

3/4" latchbolt available. Add \$118.00 to the list price of the lock.

Split finish available. Priced at higher finish.

Optional backsets, faceplates and strikes available (see next page).

Security Torx screws available. Add \$12.00 to list price of the lock.

Optional keying/keyways available.

Apollo knob with SFIC will be subject to extended lead times, consult factory for availability.

*3525 Exit, 3527 BTB Dummy, and 3573 Corridor functions are not available on Apollo knob.

Refer to catalog or website for more detailed information on functions.

Note: Hager Keyway is 7-pin only.



Apollo



Archer



August



Withnell



Function	Finish	Lever 2021 List	Case Qty.	Knob 2021 List	Case Qty.
3510 (F75) Passage	US3	176.30	6	59.40	20
	US4	176.30			
	US10	176.30			
	US10B	176.30			
	US26	176.30			
	US26D	164.05			
	US32D			59.40	20
3517 Single Dummy	US3	69.80	12	34.00	60
	US4	69.80			
	US10	69.80			
	US10B	69.80			
	US26	69.80			
	US26D	64.90			
	US32D			34.00	60
3525 (F111) Exit*	US3	176.30	6		
	US4	176.30			
	US10	176.30			
	US10B	176.30			
	US26	176.30			
	US26D	164.05			
3527 Double Dummy*	US3	139.55	6		
	US4	139.55			
	US10	139.55			
	US10B	139.55			
	US26	139.55			
	US26D	129.80			

Description

3500 Series (Continued)

Continued

	Function	Finish	Lever 2021 List	Case Qty.	Knob 2021 List	Case Qty.
3540 (F76A) Privacy		US3	200.25	6	62.65	20
		US4	200.25			
		US10	200.25			
		US10B	200.25			
		US26	200.25			
		US26D	186.30			
		US32D			62.65	20
3550 (F82A) Office		US3	222.20	6	90.50	20
		US4	222.20			
3553 (F109) Entry		US10	222.20			
		US10B	222.20			
3570 (F84) Classroom		US26	222.20			
		US26D	206.70			
3573 (F90) Corridor*/Dormitory		US32D			90.50	20
3579 (F113) Keyed Communicating						
3580 (F86) Storeroom						



Locks - 3500 Series



Latchbolts Description	Finish	2021 List	Box Qty.
3947 Spring Latch - Passage only (3510) - Standard 2-3/4" (70 mm) Backset 2-1/4" x 1-1/8" (57 mm x 29 mm) Faceplate Must specify square or round corner.	US3	32.20	10
	US4	34.30	
	US10	34.30	
	US10B	32.20	
	US26	32.20	
	US26D	32.20	
	US32D	32.20	
3949 Spring Latch - Passage only (3510) 2-3/8" (60 mm) Backset 2-1/4" x 1" (57 mm x 25 mm) Faceplate Must specify square or round corner.	US3	32.20	10
	US4	34.30	
	US10	34.30	
	US10B	32.20	
	US26	32.20	
	US26D	32.20	
	US32D	32.20	
3965 Spring Latch - Privacy only (3540) - Standard 2-3/4" (70 mm) Backset 2-1/4" x 1-1/8" (57 mm x 29 mm) Faceplate Must specify square or round corner.	US3	32.20	10
	US4	34.30	
	US10	34.30	
	US10B	32.20	
	US26	32.20	
	US26D	32.20	
	US32D	32.20	
3967 Spring Latch - Privacy only (3540) 2-3/8" (60 mm) Backset 2-1/4" x 1" (57 mm x 25 mm) Faceplate Must specify square or round corner.	US3	32.20	10
	US4	34.30	
	US10	34.30	
	US10B	32.20	
	US26	32.20	
	US26D	32.20	
	US32D	32.20	
3948 Dead Latch - 3525 and all keyed functions except Corridor 2-3/4" (70 mm) Backset 2-1/4" x 1-1/8" (57 mm x 29 mm) Faceplate Must specify square or round corner.	US3	32.20	10
	US4	34.30	
	US10	34.30	
	US10B	32.20	
	US26	32.20	
	US26D	32.20	
	US32D	32.20	
3950 Dead Latch - 3525 and all keyed functions except Corridor 2-3/8" (60 mm) Backset 2-1/4" x 1" (57 mm x 25 mm) Faceplate Must specify square or round corner.	US3	32.20	10
	US4	34.30	
	US10	34.30	
	US10B	32.20	
	US26	32.20	
	US26D	32.20	
	US32D	32.20	
3994 Dead Latch - Corridor (3573) 2-3/8" (60 mm) Backset 2-1/4" x 1" (57 mm x 25 mm) Faceplate Must specify square or round corner.	US3	32.20	10
	US4	34.30	
	US10	34.30	
	US10B	32.20	
	US26	32.20	
	US26D	32.20	
	US32D	32.20	



Latchbolts Description	Finish	2021 List	Box Qty.
3995 Dead Latch - Corridor (3573) 2-3/4" (70 mm) Backset 2-1/4" x 1-1/8" (57 mm x 29 mm) Faceplate Must specify square or round corner.	US3 US4 US10 US10B US26 US26D US32D	32.20 34.30 34.30 32.20 32.20 32.20 32.20	10
3959 Faceplate Adapter Can be used with 3500 2-3/8" backset latchbolt. Converts to 1" (25 mm) to 1-1/8" (29 mm) width.	NF	2.65	10
3932 3/4" Dead Latch (3550, 3553, 3570, 3580) 2-3/4" (70 mm) Backset 2-1/4" x 1-1/8" (57 mm x 29 mm) square corner faceplate	US3 US4 US10 US10B US26 US26D	118.35 118.35 118.35 118.35 118.35 118.35	10
3917 3-3/4" (95 mm) Backset extension link Must be used with 2-3/8" backset latchbolt to achieve 3-3/4" total backset.	NF	21.30	10
3937 5" (127 mm) Backset extension link Must be used with 2-3/4" backset latchbolt to achieve 5" total backset.	NF	23.00	10



Locks - 3500 Series



Drive-in Latchbolts		Finish	2021 List	Box Qty.
Description				
3922 2-3/4" (70 mm) Drive-In Spring Latch - Passage only (3510)		NF	32.20	20
3923 2-3/4" (70 mm) Drive-In Spring Latch - Privacy only (3540)		NF	32.20	20
3925 2-3/8" (60 mm) Drive-In Spring Latch - Passage only (3510)		NF	32.20	20
3926 2-3/8" (60 mm) Drive-In Spring Latch - Privacy only (3540)		NF	32.20	20
3924 2-3/4" (70 mm) Drive-In Dead Latch - All keyed functions except corridor		NF	32.20	20
3927 2-3/8" (60 mm) Drive-In Dead Latch - All keyed functions except corridor		NF	32.20	20
3996 2-3/8" (60 mm) Drive-In Dead Latch - Corridor (3573)		NF	32.20	20
3997 2-3/4" (70 mm) Drive-In Dead Latch - Corridor (3573)		NF	32.20	20
Strikes		Finish	2021 List	Box Qty.
Description				
3933 T-Strike with Plastic Dust Box 1-1/8" x 2-3/4" (29 mm x 70 mm), square corner For use with US32D knobs, order US26D.		US3	8.10	10
		US4	8.50	
		US10	8.50	
		US10B	8.10	
		US26	8.10	
		US26D	8.10	
		US32D	8.10	
3934 Full Lip Strike 1-5/8" x 2-1/4" (41 mm x 57 mm), square corner For use with US32D knobs, order US26D.		US3	8.10	10
		US4	8.50	
		US10	8.50	
		US10B	8.10	
		US26	8.10	
		US32D	8.10	
3935 ASA Strike Shipped Standard with 3500 Series 1-1/4" x 4-7/8" (32 mm x 124 mm), square corner 1-5/16" lip Order dust box separately.		US3	12.25	10
		US4	12.25	
		US10	12.25	
		US15	12.25	
		US10B	12.25	
		US26	12.25	
3958 Round Corner Full Lip Strike 1-5/8" x 2-1/4" (41 mm x 57 mm), round corner (1/4" radius) For use with US32D knobs, order US26D.		US3	8.10	10
		US4	8.50	
		US10	8.50	
		US10B	8.10	
		US26	8.10	
		US32D	8.10	



Strikes Description	Finish	2021 List	Box Qty.
2-669-0389 ASA Metal Dust Box	NF	6.60	10



Components and Screwpacks Description	Finish	2021 List
2-300-0048 Screwpack - 3500 Series Lever Locksets	US3/US4/ US10	12.15
2-300-0050 Screwpack - 3500 Series Lever Locksets	US10B	12.15
2-300-0052 Screwpack - 3500 Series Lever Locksets	US26/US26D	12.15
2-300-0059 Screwpack - 3500 Series Knob Locksets	US3	12.15
2-300-0060 Screwpack - 3500 Series Knob Locksets	US32D	12.15
2-300-0058 Screwpack - 3517/3527 Lever Locksets only	NF	12.15

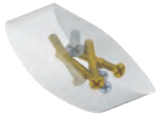
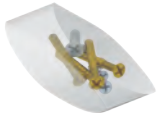
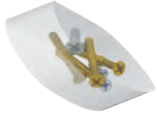

2-300-0045 Screwpack - 3517 Knob Lockset only	NF	5.15
---	----	------

2-639-3523 3500 Series thru bolt posts	NF	4.20
--	----	------



2-639-3577 Cylinder Aligning Sleeve (10 pack)	NF	3.05
---	----	------



3912 3500 Series Leverset Thru-Post Drill Jig	NF	18.75	ea
---	----	-------	----



Locks - 3600 Series



Archer  



August  



Withnell  

Description

3600 Series

Grade 2 Tubular Locks
 Fixed Cylinder, Standard
 6 Pin Cylinders, 5-Pin Keyed
 Schlage C Keyway - KD Standard
 2-3/8" - 2-3/4" (60 mm - 70 mm) adjustable backset
 2-1/4" x 1" (57 mm x 25 mm) SC Faceplate
 ASA Strike
 Levers only

Small Format Interchangeable Core option available (cores sold separately - refer to Keying/Core section).

If construction SFIC core is included with the lockset, \$51.20 will be added to the list price of the lock. Refer to keying/cores section for construction core options.

Extended Lip ASA strike available. Add \$12.00 to list price of the lock.

Split finish available, priced at higher finish.

Optional backsets, faceplates and strikes available (see next page).

Optional keying/keyways available.

Refer to catalog or website for more detailed information on functions.

Function	Finish	2021 List	Case Qty.
3610 (F75) Passage	US3	121.15	12
	US4	121.15	
	US10	121.15	
	US10B	121.15	
	US26	121.15	
	US26D	112.70	
3617 Single Dummy	US3	60.20	20
	US4	60.20	
	US10	60.20	
	US10B	60.20	
	US26	60.20	
	US26D	55.95	

Function	Finish	2021 List	Case Qty.
3640 (F76B) Privacy	US3	129.60	12
	US4	129.60	
	US10	129.60	
	US10B	129.60	
	US26	129.60	
	US26D	120.55	
3653 (F82A) Entry/Office	US3	164.60	12
	US4	164.60	
3670 (F84) Classroom	US10	164.60	
	US10B	164.60	
3680 (F86) Storeroom	US26	164.60	
	US26D	153.20	



Latchbolts Description	Finish	2021 List	Box Qty.
3951 Spring Latch - Non-keyed Functions (3600) - Standard 2-3/8" - 2-3/4" (60 mm - 70 mm) adjustable backset 2-1/4" x 1" (57 mm x 25 mm) square corner faceplate	US3	27.05	10
	US4	28.75	
	US10	28.75	
	US10B	27.05	
	US26	27.05	
	US26D	27.05	



3952 Dead Latch - All keyed functions (3600) - Standard 2-3/8" - 2-3/4" (60 mm - 70 mm) adjustable backset 2-1/4" x 1" (57 mm x 25 mm) square corner faceplate	US3	27.05	10
	US4	28.75	
	US10	28.75	
	US10B	27.05	
	US26	27.05	
	US26D	27.05	



3953 Spring Latch - Non-keyed Functions (3600) 2-3/8" - 2-3/4" (60 mm - 70 mm) adjustable backset 2-1/4" x 1" (57 mm x 25 mm) round corner faceplate	US3	27.05	10
	US4	28.75	
	US10	28.75	
	US10B	27.05	
	US26	27.05	
	US26D	27.05	



3954 Dead Latch - All keyed functions (3600) 2-3/8" - 2-3/4" (60 mm - 70 mm) adjustable backset 2-1/4" x 1" (57 mm x 25 mm) round corner faceplate	US3	27.05	10
	US4	28.75	
	US10	28.75	
	US10B	27.05	
	US26	27.05	
	US26D	27.05	



3938 Dead Latch - All keyed functions (3600) 5" (127 mm) Backset 2-1/4" x 1" (57 mm x 25 mm) Faceplate Must specify square or round corner.	US3	28.75	10
	US4	30.25	
	US10	30.25	
	US10B	28.75	
	US26	28.75	
	US26D	28.75	



3939 Spring Latch - Non-keyed functions (3600) 5" (127 mm) Backset 2-1/4" x 1" (57 mm x 25 mm) Faceplate Must specify square or round corner.	US3	28.75	10
	US4	30.25	
	US10	30.25	
	US10B	28.75	
	US26	28.75	
	US26D	28.75	



Drive-in Latchbolts Description	Finish	2021 List	Box Qty.
3914 2-3/8" - 2-3/4" (60 mm - 70 mm) Adjustable Drive-In Spring Latch - All non-keyed functions	NF	27.05	20



3915 2-3/8" - 2-3/4" (60 mm - 70 mm) Adjustable Drive-In Dead Latch - All keyed functions	NF	27.05	20
---	----	-------	----



Locks - 3600 Series

Strikes Description	Finish	2021 List	Box Qty.
3933 T-Strike with Plastic Dust Box 1-1/8" x 2-3/4" (29 mm x 70 mm), square corner	US3	8.10	10
	US4	8.50	
	US10	8.50	
	US10B	8.10	
	US26	8.10	
	US26D	8.10	
3934 Full Lip Strike 1-5/8" x 2-1/4" (41 mm x 57 mm), square corner	US3	8.10	10
	US4	8.50	
	US10	8.50	
	US10B	8.10	
	US26	8.10	
	US26D	8.10	
3935 ASA Strike Shipped standard w/ 3600 Series 1-1/4" x 4-7/8" (32 mm x 124 mm), square corner 1-5/16" lip Order dust box separately	US3	12.25	10
	US4	12.25	
	US10	12.25	
	US15	12.25	
	US10B	12.25	
	US26	12.25	
3958 Round Corner Full Lip Strike 1-5/8" x 2-1/4" (41 mm x 57 mm) round corner (1/4" radius)	US3	8.10	10
	US4	8.50	
	US10	8.50	
	US10B	8.10	
	US26	8.10	
	US26D	8.10	
2-669-0389 ASA Metal Dust Box	NF	6.60	10
3959 Faceplate Adapter 3600 Series Standard Converts 1" (25 mm) to 1-1/8" (29 mm) width	NF	2.65	10
Components and Screwpacks Description	Finish	2021 List	
2-300-0064 Screwpack - 3600 Series Lever Locksets	US3/US4	11.05	
2-300-0066 Screwpack - 3600 Series Lever Locksets	US10B	11.05	
2-300-0068 Screwpack - 3600 Series Lever Locksets	US26/US26D	11.05	
2-300-0074 Screwpack - 3617 Lever Locksets only	NF	11.05	
2-639-7159 Cylinder Aligning Sleeve (10 pack)	NF	2.80	

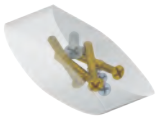
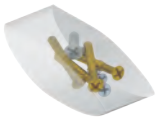

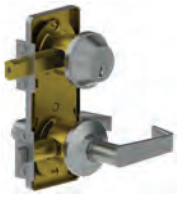

Description

3700 Series

Grade 2 Interconnected
 Fixed Cylinder, Standard
 6 Pin Cylinders, 5-Pin Keyed
 Schlage C Keyway - KD Standard
 2-3/4" (70 mm) Backset
 2-1/4" x 1-1/8" (57 mm x 29 mm) SC Faceplate
 T-Strike
 Levers only

Small Format Interchangeable Core option available (cores sold separately - refer to Keying/Core section).
 Split finish available, priced at higher finish.
 Optional backsets, faceplates and strikes available (see next page).
 Optional keying / keyways available.
 Refer to catalog or website for more detailed information on functions.



Archer



Function	Finish	2021 List	Case Qty.
3710 (F95) Entry Single Locking	US3	328.00	6
	US4	328.00	
	US10	328.00	
	US10B	328.00	
	US26	328.00	
	US26D	318.40	

Function	Finish	2021 List	Case Qty.
3796 Privacy Single Locking w/ Indicator	US3	365.50	6
	US4	365.50	
	US10	365.50	
	US10B	365.50	
	US26	365.50	
	US26D	354.85	



August



3753 (F97) Entry Double Locking	US3	361.00	6
	US4	361.00	
	US10	361.00	
	US10B	361.00	
	US26	361.00	
	US26D	350.50	



Withnell



Locks - 3700 Series



Latchbolts Description	Finish	2021 List	Box Qty.
3920	US3	32.20	10
2-3/4" (70 mm) Backset - Standard	US4	34.30	
2-1/4" x 1-1/8" (57 mm x 29 mm) Faceplate	US10	34.30	
Must specify square or round corner.	US10B	32.20	
	US26	32.20	
	US26D	32.20	

3921	US3	32.20	10
2-3/8" (60 mm) Backset	US4	34.30	
2-1/4" x 1" (57 mm x 25 mm) Faceplate	US10	34.30	
Must specify square or round corner.	US10B	32.20	
	US26	32.20	
	US26D	32.20	



3947	US3	32.20	10
Spring Latch - Entry Single Locking (3710) - Standard	US4	34.30	
2-3/4" (70 mm) Backset	US10	34.30	
2-1/4" x 1-1/8" (57 mm x 29 mm) Faceplate	US10B	32.20	
Must specify square or round corner.	US26	32.20	
	US26D	32.20	

3949	US3	32.20	10
Spring Latch - Entry Single Locking (3710)	US4	34.30	
2-3/8" (60 mm) Backset	US10	34.30	
2-1/4" x 1" (57 mm x 25 mm) Faceplate	US10B	32.20	
Must specify square or round corner.	US26	32.20	
	US26D	32.20	



3948	US3	32.20	10
Dead Latch - Entry Double Locking (3753) - Standard	US4	34.30	
2-3/4" (70 mm) Backset	US10	34.30	
2-1/4" x 1-1/8" (57 mm x 29 mm) Faceplate	US10B	32.20	
Must specify square or round corner.	US26	32.20	
	US26D	32.20	









3950	US3	32.20	10
Dead Latch - Entry Double Locking (3753)	US4	34.30	
2-3/8" (60 mm) Backset	US10	34.30	
2-1/4" x 1" (57 mm x 25 mm) Faceplate	US10B	32.20	
Must specify square or round corner.	US26	32.20	
	US26D	32.20	



3959	NF	2.65	10
Faceplate Adapter			
Can be used with 3700 2-3/8" backset latchbolt.			
Converts 1" (25 mm) to 1-1/8" (29 mm) width.			

Strikes Description	Finish	2021 List	Box Qty.
3930	US3	8.00	10
3700 Series Deadlock, Standard	US4	8.45	
Strike with Plastic Dust Box	US10	8.45	
1-1/8" x 2-3/4" (29 mm x 70 mm), square corner	US10B	8.00	
	US26	8.00	
	US26D	8.00	

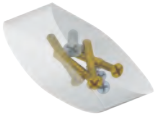
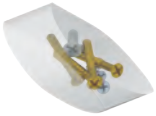
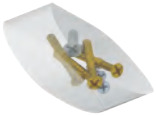

Strikes		Finish	2021 List	Box Qty.
Description				
 <p>3933 T-Strike with Plastic Dust Box 3700 Series Latchbolt, Standard 1-1/8" x 2-3/4" (29 mm x 70 mm), square corner</p>		US3	8.10	10
		US4	8.50	
		US10	8.50	
		US10B	8.10	
		US26	8.10	
		US26D	8.10	
 <p>3934 Full Lip Strike 1-5/8" x 2-1/4" (41 mm x 57 mm), square corner</p>		US3	8.10	10
		US4	8.50	
		US10	8.50	
		US10B	8.10	
		US26	8.10	
		US26D	8.10	
 <p>3958 Round Corner Full Lip Strike 1-5/8" x 2-1/4" (41 mm x 57 mm), round corner (1/4" radius)</p>		US3	8.10	10
		US4	8.50	
		US10	8.50	
		US10B	8.10	
		US26	8.10	
		US26D	8.10	
 <p>2-639-3109 Deadlock Dust Box, Plastic</p>		NF	4.05	10
Components and Screwpacks		Finish	2021 List	
Description				
 <p>2-300-0138 Screwpack - 3700 Series Lever Lockset</p>		US3/US4/ US10	11.60	
		US10B	11.60	
		US26/US26D	11.60	
 <p>2-300-0140 Screwpack - 3700 Series Lever Lockset</p>		US10B	11.60	
 <p>2-300-0141 Screwpack - 3700 Series Lever Lockset</p>		US26/US26D	11.60	
 <p>2-639-7641 3976 Emergency Key (10Pk)</p>		NF	8.70	



HOW TO ORDER EXAMPLE

3853 ESC US3 US26 ARC Full6 SCC KD 0 0 0 TW

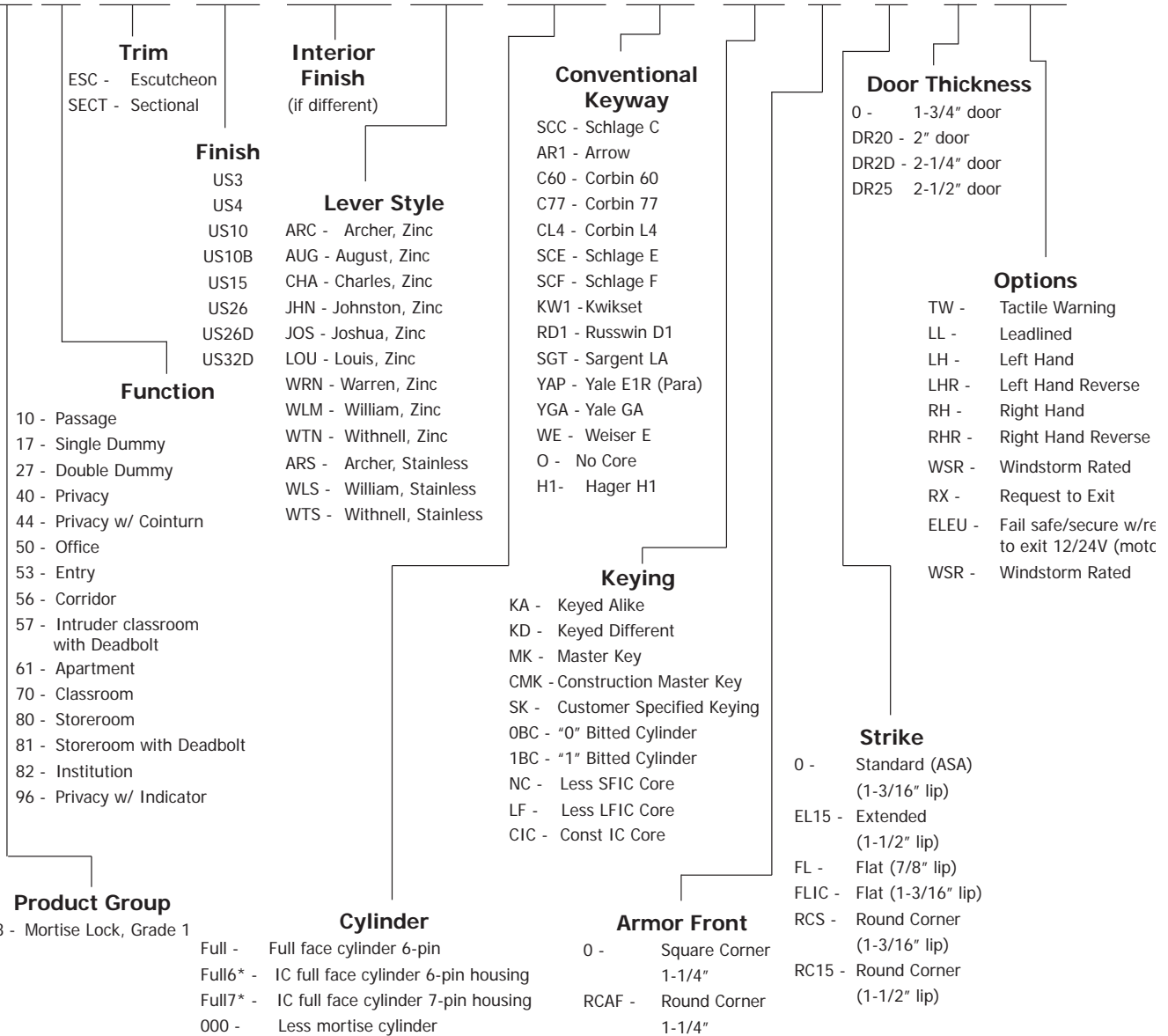

Notes:

- Finishes other than US10B, US15, US26D and US32D are subject to 90 day extended lead time.
 - If master-keyed, include master key instruction sheet with order (available online).
 - For additional keying information, refer to cylinder, core, and keying section of catalog.
 - Quick Connect option available on 3800Series Electrified Sectional and Escutcheon models (EL, EU, RX, DPM, and LM).
- Ordering example: 3880 SECT US26D WTN ELEUQC**
- Door width greater than 2-1/2", or doors with offset prep are POA with 90 day extended lead time.

Please refer to our Catalog or website (www.hagerco.com) for more detailed and series specific ordering information along with additional information including functions available, additional options, and keying information.

Description

3800 Series Sectional

Grade 1 Mortise
 Fixed Cylinder, Supplied Standard
 1-1/8" Mortise Cylinder w/ Schlage L Cam - Standard
 6 Pin Cylinders, 5-pin Keyed
 Schlage C Keyway - KD Standard
 2-3/4" (70 mm) Backset
 ASA Strike, 3985

Price includes mortise cylinder(s) where applicable and standard cylinder will be shipped with lock unless specified.

If keyed functions ordered less cylinder, subtract \$50.00 for each cylinder from list price.

Small and Large Format Interchangeable Core option available (cores sold separately - refer to Keying/Core section).

*3857, 3861, and 3882 require two cylinders.

Must specify "Full" for fixed cylinder, "ICFULL6" for SFIC 6-Pin / LFIC 6-Pin, and "ICFull7" for SFIC 7-Pin.

Options

- Lead Lined available. Add \$185.00 to the list price of lock.

- Tactile Warning available. Add \$50.00 to the list price of lock.
- For Severe Windstorm Rating, add \$40.00 to the list price of lock (3853 and 3881 only).
- Optional strikes and armor fronts available.
- Optional keying/keyways available.
- Extended Lip ASA strike available, add \$15.00 to list price of the lock.
- Lock Handing available, add \$12.00 to list price of the lock.
- ADA thumbturn available, add \$16 to list price of the lock.
- Security Torx screws available, add \$18 to the list price of the lock.

Finishes

Finishes other than 10B, 15, 26D and 32D will be subject to an extended lead time. Consult factory for availability.

**32D look on cast zinc lever; for a true 32D, specify stainless steel levers (Archer = ARS, William - WLS, Withnell = WTS).

Special door thicknesses are POA and will be subject to long lead time.

Handing required when ordering Johnston and Warren lever design.



Archer



August



William



Withnell



Charles



Johnston



Joshua



Louis



Warren

Function	Finish	Zinc 2021 List	Case Qty.	S.S. 2021 List	Case Qty.
3810S (F01) Passage	US3	403.70	6		
	US4	403.70			
	US10	403.70			
	US10B	403.70			
	US15	403.70			
	US26	403.70			
	US26D	388.15			
	US32D**	388.15		504.55	6
3817S Single Dummy	US3	137.30	6		
	US4	137.30			
	US10	137.30			
	US10B	137.30			
	US15	137.30			
	US26	137.30			
	US26D	132.00			
	US32D**	132.00		171.60	6
3827S Double Dummy	US3	273.65	6		
	US4	273.65			
	US10	273.65			
	US10B	273.65			
	US15	273.65			
	US26	273.65			
	US26D	263.10			
	US32D**	263.10		342.05	6



Locks - 3800 Series



Description

3800 Series Sectional (Continued)

Continued

Function	Finish	Zinc 2021 List	Case Qty.	S.S. 2021 List	Case Qty.
3840S (F22) Privacy	US3	463.70	6		
	US4	463.70			
	US10	463.70			
	US10B	463.70			
	US15	463.70			
	US26	463.70			
	US26D	445.90			
	US32D**	445.90		579.70	6
3844S (F22) Privacy w/ Cointurn	US3	504.95	6		
	US4	504.95			
	US10	504.95			
	US10B	504.95			
	US15	504.95			
	US26	504.95			
	US26D	485.60			
	US32D**	485.60		631.30	6
3850S Office	US3	517.75	6		
	US4	517.75			
3870S (F05) Classroom	US10	517.75			
	US10B	517.75			
3880S (F07) Storeroom	US15	517.75			
	US26	517.75			
	US26D	497.85			
	US32D**	497.85		647.20	6
3853S (F20) Entry	US3	536.40	6		
	US4	536.40			
3856S (F13) Corridor	US10	536.40			
	US10B	536.40			
	US15	536.40			
	US26	536.40			
	US26D	515.80			
	US32D**	515.80		670.50	6

Function	Finish	Zinc 2021 List	Case Qty.	S.S. 2021 List	Case Qty.
3857S* (F33) Intruder Classroom w/ Deadbolt	US3	576.15	6		
	US4	576.15			
3861S* (F09) Apartment Entrance	US10	576.15			
	US10B	576.15			
3882S* (F30) Institution	US15	576.15			
	US26	576.15			
	US26D	554.00			
	US32D**	554.00		720.15	6
3881S Storeroom w/ Deadbolt	US3	563.35	6		
	US4	563.35			
	US10	563.35			
	US10B	563.35			
	US15	563.35			
	US26	563.35			
	US26D	541.65			
	US32D**	541.65		704.20	6
3896S Privacy w/ Indicator	US3	526.55	6		
	US4	526.55			
	US10	526.55			
	US10B	526.55			
	US15	526.55			
	US26	526.55			
	US26D	506.30			
	US32D**	506.30		658.20	6



Description

3800 Series Escutcheon

Grade 1 Mortise
 Fixed Cylinder, Supplied Standard
 1-1/8" Mortise Cylinder w/ Schlage L Cam - Standard
 6 Pin Cylinders, 5-pin Keyed
 Schlage C Keyway - KD Standard
 2-3/4" (70 mm) Backset
 ASA Strike, 3985

Price includes mortise cylinder(s) where applicable and standard cylinder will be shipped with lock unless specified.

If keyed functions ordered less cylinder, subtract \$50.00 for each cylinder from list price.

Small and Large Format Interchangeable Core option available (cores sold separately - refer to Keying/Core section).

If included with the lockset, \$51.20 will be added to list price of the lock. Refer to keying/cores section for construction core options.

*3857, 3861, and 3882 require two cylinders.

Must specify "Full" for fixed cylinder, "ICFULL6" for SFIC 6-Pin / LFIC 6-Pin, and "ICFull7" for SFIC 7-Pin.

Options

- Lead Lined available. Add \$185.00 to the list price of lock.
- Tactile Warning available. Add \$50.00 to the list price of lock.
- For Severe Windstorm Rating, add \$40.00 to the list price of lock (3853 and 3881 only).
- Optional strikes and armor fronts available.
- Optional keying/keyways available
- Extended Lip ASA strike available. Add \$15.00 to list price of the lock.
- Lock Handing Available. Add \$12.00 to list price of the lock.
- Security Torx screws available, add \$18.00 to the list price of the lock.

Finishes

Finishes other than 10B, 15, 26D and 32D will be subject to an extended lead time. Consult factory for availability.

**32D look on cast zinc lever; for a true 32D, specify stainless steel levers (Archer = ARS, William = WLS, Withnell = WTS).

Special door thicknesses are POA and will be subject to long lead time.

Handing required when ordering Johnston and Warren lever design.



Archer 



August 



William 



Withnell 



Charles 



Johnston 



Joshua 



Louis 



Warren 

Function	Finish	Zinc 2021 List	Case Qty.	S.S. 2021 List	Case Qty.
3810E (F01) Passage	US3	438.00	6		
	US4	438.00			
	US10	438.00			
	US10B	438.00			
	US15	438.00			
	US26	438.00			
	US26D	421.15			
	US32D**	421.15		547.45	6
3817E Single Dummy	US3	148.95	6		
	US4	148.95			
	US10	148.95			
	US10B	148.95			
	US15	148.95			
	US26	148.95			
	US26D	143.25			
	US32D**	143.25		186.25	6
3827E Double Dummy	US3	296.85	6		
	US4	296.85			
	US10	296.85			
	US10B	296.85			
	US15	296.85			
	US26	296.85			
	US26D	285.45			
	US32D**	285.45		371.10	6



Locks - 3800 Series



Description

3800 Series Escutcheon (Continued)

Continued

Function	Finish	Zinc 2021 List	Case Qty.	S.S. 2021 List	Case Qty.
3840E (F22) Privacy	US3	503.15	6		
	US4	503.15			
	US10	503.15			
	US10B	503.15			
	US15	503.15			
	US26	503.15			
	US26D	483.80			
	US32D**	483.80		628.90	6
3844E (F22) Privacy w/ Cointurn	US3	547.95	6		
	US4	547.95			
	US10	547.95			
	US10B	547.95			
	US15	547.95			
	US26	547.95			
	US26D	526.85			
	US32D**	526.85		684.95	6
3850E Office	US3	561.75	6		
	US4	561.75			
3870E (F05) Classroom	US10	561.75			
	US10B	561.75			
3880E (F07) Storeroom	US15	561.75			
	US26	561.75			
	US26D	540.15			
	US32D**	540.15		702.20	6
3853E (F20) Entry	US3	582.00	6		
	US4	582.00			
3856E (F13) Corridor	US10	582.00			
	US10B	582.00			
	US15	582.00			
	US26	582.00			
	US26D	559.60			
	US32D**	559.30		727.45	6

Function	Finish	Zinc 2021 List	Case Qty.	S.S. 2021 List	Case Qty.
3857E* (F33) Intruder Classroom w/ Deadbolt	US3	625.10	6		
	US4	625.10			
3861E* (F09) Apartment Entrance	US10	625.10			
	US10B	625.10			
3882E* (F30) Institution	US15	625.10			
	US26	625.10			
	US26D	601.05			
	US32D**	601.05		781.35	6
3881E Storeroom w/ Deadbolt	US3	611.25	6		
	US4	611.25			
	US10	611.25			
	US10B	611.25			
	US15	611.25			
	US26	611.25			
	US26D	587.70			
	US32D**	587.70		764.00	6
3896E Privacy w/ Indicator	US3	571.35	6		
	US4	571.35			
	US10	571.35			
	US10B	571.35			
	US15	571.35			
	US26	571.35			
	US26D	549.35			
	US32D**	549.35		714.15	6

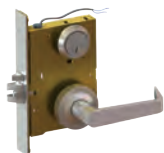

3800 Series Electrified Options - Sectional or Escutcheon Models	Add electrified charges to the list price of the lock	
Description	Function	2021 List
Outside lever continuously locked (EL) or unlocked (EU) by 12 or 24V. Latchbolt retracted by key outside or lever inside. Auxiliary latch deadlocks latchbolt when door is closed. Inside always free for immediate egress.	3880ELEU 12V/24V Storeroom - Fail Safe/Fail Secure	388.50
Both levers continuously locked (EL) or unlocked (EU) by 12 or 24V. Latchbolt retracted by key inside or outside. Auxiliary latch deadlocks latchbolt when door is closed.	3882ELEU 12V/24V Institution - Fail Safe/Fail Secure	388.50
Monitors inside lever rotation. Incorporates into fire alarm systems or in conjunction with an electromagnet. Available on 3810, 3850, 3880, 3881 or in conjunction with 3880ELEU.	RX Request to Exit	198.00
Single switch (SPDT) mounted inside lockset monitors the full extension of the latchbolt. Available on 3880, 3882, or in conjunction with 3880ELEU or 3882ELEU.	LM Latchbolt Monitoring	198.00
Single switch (SPDT Reed Magnetic Switch) mounted inside the lock monitors whether the door is fully closed. Available on 3880, 3882, or in conjunction with 3880ELEU or 3882ELEU.	DPM Door Position Monitoring	218.00

Quick Connect Option: Locks will come with molex connector attached. Quick connect option allows rapid installation of locks when used with the Hager Quick Connect harness cable. See Commercial Hinge section (page 7) for available harness sizes.

Quick Connect Ordering Example: 3880 SECT US26D WTN ELEUQC



Power Supplies	Add electrified charges to the list price of the lock	
Description	Function	2018 List
Provides power for locking devices and interfaces with building alarm controls, card readers, keypads, and other door controls.	2903 24 Volt Power Supply	Reference Electrified products section
Provides power and control for openings with an electrified locking device and automatic door operator.	2904 24 Volt Power Supply	Reference Electrified products section
Provides up to 1 amp of 12 or 24 Volt DC Power for all Hager Electrified Products	2908 24 Volt Power Supply	Reference Electrified products section
Provides up to 2 amp of 12 or 24 Volt DC Power for all Hager Electrified Products	2909 24 Volt Power Supply	Reference Electrified products section



Locks - 3800 Series



Description

3800 Series Deadlock

Grade 1 Mortise - Deadlock
 Fixed Cylinder, Standard
 1-1/8" Mortise Cylinder w/ Schlage `L' Cam Standard
 6 Pin Cylinders, 5-pin Keyed
 Schlage C Keyway - KD Standard
 2-3/4" (70 mm) Backset
 No Lip Strike, 3991

Price includes mortise cylinder(s) where applicable and standard cylinder will be shipped with deadlock unless specified.

If keyed deadlocks ordered less cylinder, subtract \$50.00 for each cylinder from list price.

Small and Large Format Interchangeable Core option available (cores sold separately - refer to Keying/Core section).

*3862 requires two cylinders

Must specify "Full" for fixed cylinder, "ICFULL6" for SFIC 6-Pin / LFIC 6-Pin, and "ICFull7" for SFIC 7-Pin.

Options

- Optional keying/keyways available.

**Hager Keyway is 7-Pin Only

Finishes other than 26D will be subject to an extended lead time. Consult factory for availability.

Refer to catalog or website for more detailed information on functions.

Function	Finish	2021 List	Case Qty.
3860S (F17) Cylinder x Thumbturn	US3	281.70	6
	US4	281.70	
	US10	281.70	
	US10B	281.70	
	US26	281.70	
	US26D	268.25	
3862S* (F16) Double Cylinder	US3	342.05	6
	US4	342.05	
	US10	342.05	
	US10B	342.05	
	US26	342.05	
	US26D	325.75	

Function	Finish	2021 List	Case Qty.
3863S (F29) Classroom (Specify Handing)	US3	342.05	6
	US4	342.05	
	US10	342.05	
	US10B	342.05	
	US26	342.05	
	US26D	325.75	
3864S (F18) Cylinder	US3	235.65	6
	US4	235.65	
	US10	235.65	
	US10B	235.65	
	US26	235.65	
	US26D	224.45	



Description

3800 Series Small Case Deadlock

Grade 1 Mortise - Deadlock
 Fixed Cylinder, Standard
 1-1/8" Mortise Cylinder w/ Schlage `L' Cam Standard
 6 Pin Cylinders, 5-pin Keyed
 Schlage C Keyway - KD Standard
 2-3/4" (70 mm) Backset
 No Lip Strike, 3999

Price includes mortise cylinder(s) where applicable and standard cylinder will be shipped with deadlock unless specified.

If keyed deadlocks ordered less cylinder, subtract \$50.00 for each cylinder from list price.

Small and Large Format Interchangeable Core option available (cores sold separately - refer to Keying/Core section).

*3832 requires two cylinders

Must specify "Full" for fixed cylinder, "ICFULL6" for SFIC 6-Pin / LFIC 6-Pin, and "ICFull7" for SFIC 7-Pin.

Options

- Optional keying/keyways available.

**Hager Keyway is 7-Pin Only

Finishes other than 26D will be subject to an extended lead time. Consult factory for availability.

Refer to catalog or website for more detailed information on functions.

Function	Finish	2021 List	Case Qty.
3830S (E06071) Cylinder x Thumbturn	US3	246.10	6
	US4	246.10	
	US10	246.10	
	US10B	246.10	
	US26	246.10	
	US26D	234.40	
3831S (E06181) Door Bolt Thumbturn only	US3	210.40	6
	US4	210.40	
	US10	210.40	
	US10B	210.40	
	US26	210.40	
	US26D	200.35	
3832S* (E06061) Double Cylinder	US3	298.70	6
	US4	298.70	
	US10	298.70	
	US10B	298.70	
	US26	298.70	
	US26D	284.45	

Function	Finish	2021 List	Case Qty.
3833S (E06091) Classroom (Specify Handing)	US3	298.70	6
	US4	298.70	
	US10	298.70	
	US10B	298.70	
	US26	298.70	
	US26D	284.45	
3834S (E06081) Cylinder	US3	205.80	6
	US4	205.80	
	US10	205.80	
	US10B	205.80	
	US26	205.80	
	US26D	196.05	



Locks - 3800 Series



Description

3800 Series Sliding Door Mortise Lock

Sliding Door Mortise Lock
 Fixed Cylinder, Standard
 1-1/8" Mortise Cylinder w/ Schlage `L' Cam Standard
 6 Pin Cylinders, 5-pin Keyed
 Schlage C Keyway - KD Standard
 2-3/4" (70 mm) Backset
 No Lip Strike

Price includes mortise cylinder(s) where applicable and standard cylinder will be shipped with deadlock unless specified.

If keyed deadlocks ordered less cylinder, subtract \$50.00 for each cylinder from list price.

Small and Large Format Interchangeable Core option available (cores sold separately - refer to Keying/Core section).

*3837 requires two cylinders

Must specify "Full" for fixed cylinder, "ICFULL6" for SFIC 6-Pin / LFIC 6-Pin, and "ICFull7" for SFIC 7-Pin.

Options

- Optional keying/keyways available.

**Hager Keyway is 7-Pin Only

Refer to catalog or website for more detailed information on functions.

Function	Finish	2021 List	Case Qty.
3835S Cylinder x Thumbturn	US26D	186.25	6
3836S Single Cylinder	US26D	186.25	6
3837S Double Cylinder	US26D	219.30	6

Function	Finish	2021 List	Case Qty.
3838S Thumbturn Only	US26D	165.40	6
3839S Thumbturn w/ Emergency Key (Privacy)	US26D	178.65	6



Components, Strikes, and Screwpacks Description	Finish	2021 List
Zinc Mortise Lock Levers (each) Consult factory for part numbers and other finishes. (May be subject to extended lead times)	US26D/US32D	56.45
Stainless Mortise Lock Levers (each) Consult factory for part numbers and other finishes. (May be subject to extended lead times)	US32D	85.35
3918 Tapered Cylinder Collar For use with sectional mortise lock, standard with 1-1/8" cylinder, 1-3/4" door. Includes wave washer and shim.	US26D US10B US15 / US32D	11.65 13.65 11.65
3928 Flat Cylinder Collar 1-3/8" diameter, 11/32" thick For use with double cylinder sectional mortise locks and other special cylinders and door thicknesses. Consult factory. Includes wave washer and shim.	US26D US10B US15 / US32D	11.65 13.65 11.65
3985 Standard Lip Strike Square corner 1-1/4" x 4-7/8" x 1-3/16" (32 mm x 124 mm x 30 mm)	US10B US32D*	21.00 19.65
3986 Extended Lip Strike Square corner 1-1/4" x 4-7/8" x 1-1/2" (32 mm x 124 mm x 38 mm)	US10B US32D*	21.00 19.65
3987 Standard Lip Strike Round corner 1-1/4" x 4-7/8" x 1-3/16" (32 mm x 124 mm x 30 mm)	US10B US32D*	21.00 19.65
3988 Extended Lip Strike Round corner 1-1/4" x 4-7/8" x 1-1/2" (32 mm x 124 mm x 38 mm)	US10B US32D*	21.00 19.65
3989 Flat Lip Strike Square corner 1-1/4" x 4-7/8" x 7/8" (32 mm x 124 mm x 22 mm)	US10B US32D*	21.00 19.65
3990 Extended Flat Lip Strike Square corner 1-1/4" x 4-7/8" x 1-3/16" (32 mm x 124 mm x 30 mm)	US10B US32D*	21.00 19.65
3991 Square corner Full Case Deadlock Strike (3860, 3862, 3863, 3864) 1-1/4" x 4-7/8" (32 mm x 124 mm)	US10B US32D*	18.25 17.05

*For use with US15 and US26D mortise locks, order US32D finish.



Locks - 3800 Series



Components, Strikes, and Screwpacks Description	Finish	2021 List
3999	US10B	18.25
For Small Case	US32D*	17.05
No Lip Strike		
Square corner		
1-1/8" x 3- 1/2" (29 mm x 89 mm)		
2-669-0389	NF	6.60
ASA Metal Dust Box		
2-669-0224	US10B	20.95
Armor Front 1-1/4" Square corner (Latch x Aux Latch x Deadbolt) - 3853, 3881		
2-669-0226	US32D*	19.55
Armor Front 1-1/4" Square corner (Latch x Aux Latch x Deadbolt) - 3853, 3881		
2-669-0230	US10B	20.95
Armor Front 1-1/4" Square corner (Latch x Aux Latch) - 3850, 3861, 3870, 3880, 3882		
2-669-0232	US32D*	19.55
Armor Front 1-1/4" Square corner (Latch x Aux Latch) - 3850, 3861, 3870, 3880, 3882		
2-669-0236	US10B	20.95
Armor Front 1-1/4" Square corner (Latch x Deadbolt) - 3856, 3857		
2-669-0238	US32D*	19.55
Armor Front 1-1/4" Square corner (Latch x Deadbolt) - 3856, 3857		
2-669-0242	US10B	20.95
Armor Front 1-1/4" Square corner (Latch) - 3810, 3840, 3844, 3896		
2-669-0244	US32D*	19.55
Armor Front 1-1/4" Square corner (Latch) - 3810, 3840, 3844, 3896		
2-669-0248	US10B	20.95
Armor Front 1-1/4" Square corner (Blank)		
2-669-0250	US32D*	19.55
Armor Front 1-1/4" Square corner (Blank)		
2-669-0254	US10B	20.95
Armor Front 1-1/4" Square corner (Deadbolt) - 3860, 3862, 3863, 3864		
2-669-0256	US32D*	19.55
Armor Front 1-1/4" Square corner (Deadbolt) - 3860, 3862, 3863, 3864		
2-669-0296	US10B	20.95
Armor Front 1-1/4" Round corner (Latch x Aux Latch x Deadbolt) - 3853, 3881		
2-669-0298	US32D*	19.55
Armor Front 1-1/4" Round corner (Latch x Aux Latch x Deadbolt) - 3853, 3881		
2-669-0302	US10B	20.95
Armor Front 1-1/4" Round corner (Latch x Aux Latch) - 3850, 3861, 3870, 3880, 3882		
2-669-0304	US32D*	19.55
Armor Front 1-1/4" Round corner (Latch x Aux Latch) - 3850, 3861, 3870, 3880, 3882		

*For use with US15 and US26D mortise locks, order US32D finish.



Components, Strikes, and Screwpacks Description	Finish	2021 List
2-669-0308 Armor Front 1-1/4" Round corner (Latch x Deadbolt) - 3856, 3857	US10B	20.95
2-669-0310 Armor Front 1-1/4" Round corner (Latch x Deadbolt) - 3856, 3857	US32D*	19.55
2-669-0314 Armor Front 1-1/4" Round corner (Latch) - 3810, 3840, 3844, 3896	US10B	20.95
2-669-0316 Armor Front 1-1/4" Round corner (Latch) - 3810, 3840, 3844, 3896	US32D*	19.55
2-669-0320 Armor Front 1-1/4" Round corner (Blank)	US10B	20.95
2-669-0322 Armor Front 1-1/4" Round corner (Blank)	US32D*	19.55
2-669-0326 Armor Front 1-1/4" Round corner (Deadbolt) - 3860, 3862, 3863, 3864	US10B	20.95
2-669-0328 Armor Front 1-1/4" Round corner (Deadbolt) - 3860, 3862, 3863, 3864	US32D*	19.55
2-669-0408 Thumbturn (3850, 3853, 3856, 3860, 3881)	US10B	34.15
2-669-0410 Thumbturn (3850, 3853, 3856, 3860, 3881)	US26D	31.90
2-669-0411 Thumbturn (3850, 3853, 3856, 3860, 3881)	US15/US32D	31.90
2-669-0415 Thumbturn (3840, 3844, 3896)	US10B	34.15
2-669-0417 Thumbturn (3840, 3844, 3896)	US26D	31.90
2-669-0418 Thumbturn (3840, 3844, 3896)	US15/US32D	31.90
2-669-0422 Emergency Release (3840, 3896)	US10B	7.45
2-669-0424 Emergency Release (3840, 3896)	US26D	6.95
2-669-0425 Emergency Release (3840, 3896)	US32D	6.95
2-669-0111 Screwpack (3850S, 3853S, 3856S, 3840S, 3844S, 3896S)	US10B	27.20
2-669-0112 Screwpack (3850S, 3853S, 3856S, 3840S, 3844S, 3896S)	US32D	25.40
2-669-0115 Screwpack (3870S, 3861S, 3857S, 3865S, 3810S)	US10B	27.20
2-669-0116 Screwpack (3870S, 3861S, 3857S, 3865S, 3810S)	US32D	25.40

*For use with US15 and US26D mortise locks, order US32D finish.

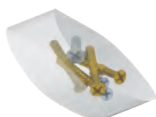

Locks - 3800 Series

Components, Strikes, and Screwpacks Description	Finish	2021 List
2-669-0119 Screwpack (3850E, 3853E, 3870E, 3861E, 3857E, 3856E, 3840E, 3844E, 3810E, 3896E)	US10B	27.20
2-669-0120 Screwpack (3850E, 3853E, 3870E, 3861E, 3857E, 3856E, 3840E, 3844E, 3810E, 3896E)	US32D	25.40
2-669-0123 Screwpack (3881S)	US10B	27.20
2-669-0124 Screwpack (3881S)	US32D	25.40
2-669-0127 Screwpack (3880S)	US10B	27.20
2-669-0128 Screwpack (3880S)	US32D	25.40
2-669-0131 Screwpack (3880E, 3881E)	US10B	27.20
2-669-0132 Screwpack (3880E, 3881E)	US32D	25.40
2-669-0135 Screwpack (3862S, 3863S, 3864S)	US10B	13.60
2-669-0136 Screwpack (3862S, 3863S, 3864S)	US32D	12.70
2-669-0147 Screwpack (3860S)	US10B	13.60
2-669-0148 Screwpack (3860S)	US32D	12.70
2-669-0139 Screwpack (3882S)	US10B	17.70
2-669-0140 Screwpack (3882S)	US32D	16.55
2-669-0143 Screwpack (3882E)	US10B	17.70
2-669-0144 Screwpack (3882E)	US32D	16.55
2-669-0157 Screwpack (3827S)	NF	10.20
2-669-0158 Screwpack (3827E)	NF	10.20
2-669-0167 Screwpack (3817S)	NF	7.10
2-669-0168 Screwpack (3817E)	NF	7.10
2-669-0365 Thru-Bolt Bag (2 each) 1-3/8" to 2" door	NF	8.70
2-669-0366 Thru-Bolt Bag (2 each) Over 2" to 2-1/2" door	NF	9.65
2-669-0613 Square Spindles - 5-pk	NF	26.50





Components, Strikes, and Screwpacks		
Description	Finish	2021 List
2-669-0597 Armor Front Screws - 10-pk	26D	11.10
2-669-0615 Lock Case (3853)	NF	182.00
2-669-0616 Lock Case (3881)	NF	182.00
2-669-0600 Lock Case (3856, 3857)	NF	216.00
2-669-0603 Lock Case (3850, 3870, 3861, 3876)	NF	178.75
2-669-0604 Lock Case (3880)	NF	178.75
2-669-0605 Lock Case (3810)	NF	127.85
2-669-0641 Lock Case (3840, 3844, 3896)	NF	178.75
2-669-0635 Lock Case (3853 Windstorm Rated)	NF	216.00
2-669-0636 Lock Case (3881 Windstorm Rated)	NF	216.00
2-669-0643 Lever Adapters (Keepers) for Stainless Levers	NF	6.40



Locks - Cylinders/Keying



Fixed Cylinders/Key-in-Lever - Keying Charges		
Description	Finish	2021 List
Keyed Different (KD) 5-pin (Standard), 6-pin, 7-pin (Hager Keyway only) available		N/C
Keyed Alike (KA) 5-pin (Standard), 6-pin, 7-pin (Hager Keyway Only). 0-Bitted and 1-Bitted available*		N/C
Master Keyed (MK) - Add to list price of lock**		21.10
Construction Master Keyed (CMK) - Add to the standard master key charge and the list price of lock (Schlage C / Hager H1 only)**		14.15
Keyed to specific or existing number - Add to list price of lock		7.50
Extra Cut Keys - specify change key, MK, GMK or CMK (3961 - 5-pin, 3962 - 6-pin, 3908 - 7-pin Hager only)		6.35
Key Markings - Standard key symbols (AA1) - Visual Key Control (VKC)		No Charge
Key Markings - Non-standard code - Visual Key Control (VKC)		6.05
Custom Cylinder Markings/ Concealed Key Control (CKC) - limited to 6 characters		6.05
3998 - Bitting List (No charge if ordered with master keying) - Factory Keyed		175.00
Bitting List - Hager designed system - Keyed by others		175.00
Other keyways available (refer to Catalog or website) - Add to list price of lock		15.65

*Allow 7 working days for 0-bitted, 1-bitted, and KA orders

** Allow 20 working days for factory master key orders.

Notes:

1. Lock prices do not include keying charges.
2. Locks furnished with 6-pin cylinder, 5-pin keyed, Schlage C keyway keyed different unless otherwise specified.
3. Please include Master Key Instruction Sheet with order, available online or in catalog. Failure to provide will delay order.

Fixed Cylinder Key			
Description	Finish	2021 List	Box Qty.
3955 Key Blank 5-Pin C Keyway Other keyways available*	NF	1.85	50
3956 Key Blank 6-Pin C Keyway Other keyways available*	NF	2.20	50
3961 Cut 5-Pin Key 5-Pin C Keyway Other keyways available*	NF	6.35	50





Fixed Cylinder Key Description	Finish	2021 List	Box Qty.
3962 Cut 6-Pin Key 6-Pin C Keyway Other keyways available*	NF	6.35	50



3907 Key Blank 7-Pin H Keyways	NF	2.55	50
--	----	------	----



3908 Cut 7-Pin Key 7-Pin H Keyways	NF	6.35	50
--	----	------	----

*Refer to catalog or website for more information on available keyways.



Fixed Cylinder/Tailpieces Description	Finish	2021 List
3960 or 3906 (Hager Keyway Only) Fixed Cylinder Kit - Includes two keys 3960 - C Keyway; 6-pin cylinder, 5-pin keyed - Standard 3906 - H Keyways, 7-pin cylinder - Standard Additional options and keyways available at additional cost (refer to catalog or website). Tailpiece optional when ordering (No Charge) Please include cylinder instructions and ordering guide sheet with order (available online).	US4 US26D	52.85 52.85



2-639-7000 Tailpiece 1 Pack of 10 tailpieces for use with 3453L, 3450L, 3480L, 3482L, 2580L	NF	13.55
--	----	-------



2-639-7001 Tailpiece 2 Pack of 10 tailpieces for use with 3470L.	NF	13.55
---	----	-------



2-639-7002 Tailpiece 3 Pack of 10 tailpieces for use with 3453K, 3480K, 3550L, 3553L, 3553K, 3579L, 3580L, 3580K, 3753L, 2550L, 2553L	NF	13.55
--	----	-------













2-639-7003 Tailpiece 4 Pack of 10 tailpieces for use with 3470K, 3570K	NF	13.55
---	----	-------



2-639-7005 Tailpiece 6 Pack of 10 tailpieces for use with 3114 (Exterior Cyl.), 3214 (Exterior	NF	13.55
---	----	-------



Locks - Cylinders/Keying

Fixed Cylinder/Tailpieces			
Description	Finish	2021 List	
 <p>2-639-7006 Tailpiece 7 Pack of 10 tailpieces for use with 3114 (Interior Cyl.), 3214 (Interior)</p>	NF	13.55	
 <p>2-639-7007 Tailpiece 8 Pack of 10 tailpieces for use with 3115, 3118, 3215</p>	NF	13.55	
 <p>2-639-7008 Tailpiece 9 Pack of 10 tailpieces for use with 3653L, 3670L, 3680L</p>	NF	13.55	
 <p>2-639-7018 Tailpiece W Pack of 10 tailpieces for use with 3473L</p>	NF	13.55	
 <p>2-639-7192 Tailpiece K Pack of 10 tailpieces for use with 47KE, 47KN</p>	NF	13.55	
 <p>2-639-7087 Tailpiece Z Pack of 10 tailpieces for use with 3570L and 3573L</p>	NF	13.55	
 <p>2-639-7094 Tailpiece X Pack of 10 tailpieces for use with 3495L</p>	NF	13.55	
 <p>2-639-7322 Tailpiece V Pack of 10 tailpieces for use with 3473L</p>	NF	13.55	
Fixed Cylinder - Rim Cylinder			
Description	Finish	2021 List	Box Qty.
 <p>3901 Fixed Rim Cylinder 6-Pin Cylinder, 5-Pin Keyed; 7-Pin Cylinder (Hager Keyway Only) Schlage C Keyway or Hager Keyway - Keyed Different Standard Shipped with breakoff tailpiece attached. Shipped with collar, mounting plate, and breakoff screws.</p>	US3	50.00	1
	US4	53.10	
	US10	53.10	
	US10B	50.00	
	US26	50.00	
	US26D	50.00	
 <p>3903 Rim Dummy Cylinder Shipped with mounting plate, and breakoff screws.</p>	US3	33.40	1
	US4	33.40	
	US10	33.40	
	US10B	33.40	
	US26	33.40	
	US26D	33.40	





Fixed Cylinder - Rim Cylinder Accessories	Finish	2021 List	Box Qty.
---	--------	-----------	----------

2-639-7058 Long breakoff tailpiece - 2-3/8" (60 mm)	NF	2.45	1
---	----	------	---

2-300-0118 Extra long breakoff screws - 2-3/8" (60 mm) (2 each)	NF	1.70	2
---	----	------	---

2-649-0137 Retaining cup Can be used with 45PN, 47PN, and 47RN	NF	9.85	1
---	----	------	---

Fixed Cylinder - Mortise Cylinder	Finish	2021 List	Box Qty.
-----------------------------------	--------	-----------	----------

3902 Fixed Cylinder Mortise Cylinder 6-Pin Cylinder, 5-Pin Keyed, 7-Pin Cylinder (Hager Keyway Only) Schlage C Keyway or Hager Keyways - Keyed Different Standard Specify 1-1/8" (29 mm), 1-1/4" (32 mm) or 1-5/8" (41 mm) Shipped with standard cam attached and Adams Rite cam loose in box; specify if different. Specify Schlage L cam when ordering cylinders for use in Hager mortise locks.	US3	50.00	1
	US4	53.10	
	US10	53.10	
	US10B	50.00	
	US26	50.00	
	US26D	50.00	

3904 Mortise Dummy Specify 1-1/8" (29 mm) or 1-1/4" (32 mm)	US3	41.20	1
	US4	43.80	
	US10	43.80	
	US10B	41.20	
	US26	41.20	
	US26D	41.20	

3905 Mortise ADA Turn Knob Specify 1-1/8" (29 mm) or 1-1/4" (32 mm) Shipped with Schlage L cam attached, specify if different.	US3	72.05	1
	US10B	72.05	
	US26D	72.05	

Fixed Cylinder - Mortise Cylinder Cams	Finish	2021 List	Box Qty.
--	--------	-----------	----------

3971 Yale Cam .722" (18 mm)	US2C	4.30 ea.	1
--	------	----------	---

3972 Adams Rite Cam .560" (14 mm) Shipped Loose in box w/ standard 3902	US2C	4.30 ea.	1
---	------	----------	---

3973 Standard Cloverleaf .741" (19 mm)	US2C	4.30 ea.	1
---	------	----------	---

3974 Marks Cam R.755" (19 mm)	US2C	4.30 ea.	1
--	------	----------	---



Locks - Cylinders/Keying



Fixed Cylinder - Mortise Cylinder Cams			
Description	Finish	2021 List	Box Qty.
3975 Standard Cam R.723" (18 mm) Shipped standard w/ 3902	US2C	4.30 ea.	1
3976 Schlage L Cam .637" (16 mm) For use w/ all keyed function 3800 Series Mortise Locks.	US2C	4.30 ea.	1
3977 Sargent/Yale Cam .733" (18.6 mm)	US2C	4.30 ea.	1
3978 Corbin Russwin/Best Cloverleaf Cam .725" (18.5 mm)	US2C	4.30 ea.	1
Small Format Interchangeable Core - Keying Charges/Cores			
Description	Finish	2021 List	
3981-U Uncombined Core 6-Pin (includes two key blanks), specify US4 or US26D		41.90	
3982-U or 3909 (Hager SFIC Only) Uncombined Core 7-Pin (includes two key blanks), specify US4 or US26D		41.90	
3981-C Combined Core 6-Pin (includes two operating keys), specify US4, US26D. Specify KA*, KD*, MK**. Specify number of control keys needed.		51.20	
3982-C or 3969 (Hager SFIC Only) Combined Core 7-Pin (includes two operating keys), specify US4, US26D. Specify KA*, KD*, MK**. Specify number of control keys needed.		51.20	
3981-BLU or RED (Best A) Construction Core 6-Pin (includes two operating keys). Specify number of control keys. Two control keys provided as a default.		51.20	
3982-BLU or RED (Best A) Construction Core 7-Pin (includes two operating keys). Specify number of control keys. Two control keys provided as a default.		51.20	
Key Markings: Standard key symbols (AA1) - Visual Key Control (VKC)		N/C	
Key Markings: Non-standard code - Visual Key Control (VKC)		6.05	
Custom Cylinder Markings/ Concealed Key Control (CKC) - Limited to 6 characters		6.05	
3984 Cut Keys - Control Keys, Extra change keys, or Master Keys		6.35	
3908 Cut Keys (Hager Keyway Only) - Control Keys, Extra change keys, or Master Keys		6.35	
3998 Bitting list (no charge if ordered with master key) - Factory keyed		175.00	
Bitting list - Hager designed system - Keyed by others		175.00	



Small Format Interchangeable Core - Keying Charges/Cores Description	Finish	2021 List	
---	--------	-----------	--

*Allow 7 working days for KD and KA orders
 ** Allow 20 working days for factory master key orders.
 Notes:
 1. Lock price includes keying charges.
 2. Cores are supplied Best A keyed different unless otherwise specified.
 3. Please include Master Key Instruction Sheet with order, available online or in catalog. Failure to provide will delay order.
 4. Construction Cores - Receive full credit, less shipping, of original cost upon return of cores and keys.

Small Format Interchangeable Core - Keys Description	Finish	2021 List	Box Qty.
---	--------	-----------	----------



3983 Small Format Interchangeable Core Key Blanks Best Keyways Used with 6-pin and 7-pin cores	NF	2.55	50
--	----	------	----

3984 Small Format Interchangeable Core Cut Key Best Keyways Used with 6-pin and 7-pin cores	NF	6.35	50
---	----	------	----

2-639-7168 SFIC 6-pin "BLUE" Construction Control Key Best A Keyway	NF	6.35	1
--	----	------	---

2-639-7169 SFIC 7-pin "BLUE" Construction Control Key Best A Keyway	NF	6.35	1
--	----	------	---

2-639-7113 SFIC 6-pin "RED" Construction Control Key Best A Keyway	NF	6.35	1
---	----	------	---

2-639-7170 SFIC 7-pin "RED" Construction Control Key Best A Keyway	NF	6.35	1
---	----	------	---



3907 Small Format Interchangeable Core Key Blanks Hager Keyways (7-pin cores only)	NF	2.55	50
---	----	------	----



3908 Small Format Interchangeable Core Cut Key Hager Keyways (7-pin cores only)	NF	6.35	50
--	----	------	----

Small Format Interchangeable Core - Tailpieces Description	Finish	2021 List	Box Qty.
---	--------	-----------	----------



2-639-7060 Pack of 10 tailpieces and compression springs for use with 2500/3500 Series SFIC lever locksets. 6-pin/7-pin cores	NF	15.60	10
--	----	-------	----



Locks - Cylinders/Keying



Small Format Interchangeable Core - Tailpieces		Finish	2021 List	Box Qty.
Description				

2-639-7061	Pack of 10 tailpieces and compression springs for use with 3400/3500 Series SFIC knob locksets. 6-pin/7-pin cores	NF	15.60	10
-------------------	--	----	-------	----

2-639-7090	Pack of 10 tailpieces and compression springs for use with 3753 interconnected lock SFIC lever locksets. 6-pin/7-pin cores	NF	15.60	10
-------------------	---	----	-------	----

2-639-7091	Pack of 10 tailpieces for use with 3114/3214 SFIC housing deadlock. 6-pin/7-pin cores	NF	15.60	10
-------------------	--	----	-------	----

2-639-7095	Pack of 10 tailpieces for use with 3115/3118/3215/3710DL/3753DL SFIC housing deadlock. 6-pin/7-pin cores	NF	15.60	10
-------------------	---	----	-------	----

Small Format Interchangeable Core - Rim Cylinder Housing		Finish	2021 List	Box Qty.
Description				

3901	Rim Cylinder - Small Format Interchangeable Core Housing Specify 6-pin or 7-pin Supplied with long tailpiece standard, collar, mounting plate, and breakoff screws. Cores sold separately.	US3 US4 US10 US10B US26 US26D	50.00 53.10 53.10 50.00 50.00 50.00	1
-------------	---	--	--	---

Small Format Interchangeable Core - Mortise Cylinder Housing		Finish	2021 List	Box Qty.
Description				

3902	Mortise Cylinder - Small Format Interchangeable Core Housing Specify length 1-1/4" (6-pin) or 1-3/8" (7-pin) or 1-5/8" for mortise exit devices. Shipped with standard cam attached and Adams Rite cam loose in box (specify if different). Cores sold separately. 1/4" blocking ring included. Specify Schlage L cam when ordering new cylinders for use in Hager mortise lock.	US3 US4 US10 US10B US26 US26D	50.00 53.10 53.10 50.00 50.00 50.00	1
-------------	--	--	--	---

Small Format Interchangeable Core - Mortise Cylinder Cams		Finish	2021 List	Box Qty.
Description				

2-639-7082	Yale Standard Cam Shipped standard w/ 3902 Small Format Interchangeable Core (SFIC) Housing.	US2C	3.85 ea	1
-------------------	---	------	---------	---

2-639-7083	Adams Rite Cam Shipped loose in box w/ standard 3902 Small Format Interchangeable Core (SFIC) Housing.	US2C	3.85 ea	1
-------------------	---	------	---------	---

2-639-7084	Corbin/Best Cloverleaf Cam	US2C	3.85 ea	1
-------------------	----------------------------	------	---------	---



Small Format Interchangeable Core - Mortise Cylinder Cams			
Description	Finish	2021 List	Box Qty.

2-639-7085 Schlage 'L' Cam For use w/ all keyed functions on 3800 Series Mortise Locks and 46CE.	US2C	3.85 ea	1
---	------	---------	---

2-639-7086 Sargent Yale Cam	US2C	3.85 ea	1
---------------------------------------	------	---------	---

Large Format Interchangeable Core - Keying Charges/Cores		
Description	Finish	2021 List

3919-Z Zero Bitted Core 6-Pin (includes two key blanks), specify US4 or US26D		53.00
---	--	-------

3919-C Combinated Core 6-Pin (includes two change keys), specify US4 or US26D. Specify KA*, KD*, MK**. Specify number of control keys needed.		64.75
--	--	-------

3919-BLA (Schlage C) Construction Core 6-Pin (includes two operating keys). Specify number of control keys. Two control keys provided as a default.		64.75
---	--	-------

Key Markings: Standard key symbols (AA1) - Visual Key Control (VKC)		N/C
---	--	-----

Key Markings: Non-standard code - Visual Key Control (VKC)		6.05
--	--	------

Core Markings (Visual or Concealed)		6.05
-------------------------------------	--	------

3998 Bitting list (no charge if ordered with master key) - Factory keyed		175.00
--	--	--------

Bitting list - Hager designed system - Keyed by others		175.00
--	--	--------

*Allow 7 working days for KD and KA orders

** Allow 20 working days for factory master key orders.

Notes:

1. Cores are available in Schlage C keyway only.
2. Please include Master Key Instruction Sheet with order, available online or in catalog. Failure to provide will delay order.
3. Construction Cores - Receive full credit, less shipping, of original cost upon return of cores and keys.

Large Format Interchangeable Core - Keys		
Description	Finish	2021 List

3956 LFIC Key Blanks Schlage C Keyway		2.20
--	--	------

3962 LFIC Cut Keys Schlage C Keyway		6.35
--	--	------

2-639-7649 LFIC Control Key Blanks Schlage C Keyway		2.20
--	--	------



Locks - Cylinders/Keying

Large Format Interchangeable Core - Keys		Finish	2021 List
Description			

3963	LFIC Control Cut Keys Schlage C Keyway		6.35
-------------	---	--	------

2-639-7132	LFIC 6-Pin "Black" Construction Control Key Schlage C Keyway		6.35
-------------------	---	--	------



Large Format Interchangeable Core - Tailpieces			Box Qty.
Description	Finish	2021 List	

2-639-7645		2.45	1
For use with 3450, 3453, 3480 and 3482 LFIC lever locksets			



2-639-7646		2.45	1
For use with 3470 LFIC lever locksets			



2-639-7647		2.45	1
For use with 3473 and 3495 LFIC lever locksets			



Large Format Interchangeable Core - Rim Cylinder Housing			Box Qty.
Description	Finish	2021 List	

3901			1
Rim Cylinder - Large Format Interchangeable Core Housing			
Supplied with tailpiece, collar, mounting plate, and breakoff screws.			
6-Pin Only			
Cores sold separately.			
	US3	50.00	
	US4	53.10	
	US10	53.10	
	US10B	50.00	
	US26	50.00	
	US26D	50.00	



LFIC - Rim Cylinder Accessories			Box Qty.
Description	Finish	2021 List	

2-639-7578	NF	3.00	1
Breakoff Tailpiece Assembly			



2-300-0175	NF	1.70	2
Breakoff Screws - 2-1/8" (54mm) (2each)			



Large Format Interchangeable Core - Mortise Cylinder Housing			Box Qty.
Description	Finish	2021 List	

3902			1
Mortise Cylinder - Large Format Interchangeable Core Housing			
1-1/2" Length			
Shipped with standard cam attached and Adams Rite cam loose in box (specify if different).			
Cores sold separately.			
Specify Schlage L cam when ordering cylinders for use in Hager mortise locks.			
	US3	50.00	
	US4	53.10	
	US10	53.10	
	US10B	50.00	
	US26	50.00	
	US26D	50.00	





Large Format Interchangeable Core - Mortise Cylinder Cams		Finish	2021 List	Box Qty.
2-639-7570 Yale Standard Cam Shipped standard w/ 3902 Large Format Interchangeable Core (LFIC) Housing.		US2C	4.50 ea	1
2-639-7571 Adams Rite Cam Shipped loose in box w/ standard 3902 Large Format Interchangeable Core (LFIC) Housing.		US2C	4.50 ea	1
2-639-7572 Schlage 'L' Cam For use w/ all keyed functions on 3800 Series Mortise Locks and 46CE.		US2C	4.50 ea	1
2-639-7573 Corbin/Best Cloverleaf Cam		US2C	4.50 ea	1
2-639-7574 Sargent/Yale Cam		US2C	4.50 ea	1
Miscellaneous		Finish	2021 List	Box Qty.
3911 2500/3400 Series Lever Thru-Bolt Jig - Steel		NF	18.75	ea
3912 3500 Series Lever Thru-Bolt Jig - Steel		NF	18.75	ea
3959 Faceplate Adaptor Can be used with a 2-3/8" backset on the 2500, 3500, 3600, and 3700 Series lockset and 3200 Series deadlocks. Converts 1" (25 mm) to 1-1/8" (29 mm) width.		NF	2.65	ea
3968 Aluminum Blocking Rings Sizes available 1/8" (3.2 mm), 3/16" (4.8 mm), 1/4" (6.4 mm), 5/16" (7.9 mm), 3/8" (9.5 mm), 1/2" (12.5 mm)		BGA CLR DBA US10	5.85 5.85 5.85 5.85	ea
3968 Aluminum Blocking Rings Sizes available 1/8" (3.2 mm), 1/4" (6.4 mm),		US3 US4 US10B US26 US26D	5.85 5.85 5.85 5.85 5.85	
3979 Mortise Cam Screws - Fixed Cylinder Mortise Cylinder Only		NF	0.35	each



Locks - Cylinders/Keying



Miscellaneous Description	Finish	2021 List	Box Qty.
3980 Cash Box Nut	NF	8.40	each



2-639-7680 Mortise Cam Screws - SFIC Mortise Cylinder Only	NF	0.35	each
--	----	------	------



Cylinder Collars Description	Finish	2021 List	Box Qty.
2-647-0012 Cylinder Collar - 7/8" projection	US3	19.10	each
2-647-0013 Cylinder Collar - 7/8" projection	ALM	19.10	each
2-647-0014 Cylinder Collar - 7/8" projection	DBZ	19.10	each
2-647-0015 Cylinder Collar - 7/8" projection	US15 / US32D	19.10	each
2-647-0016 Cylinder Collar - 7/8" projection	US4	19.10	each
2-647-0017 Cylinder Collar - 7/8" projection	US10	19.10	each
2-647-0018 Cylinder Collar - 7/8" projection	US10B	19.10	each
2-647-0019 Cylinder Collar - 7/8" projection	US26	19.10	each
2-647-0020 Cylinder Collar - 7/8" projection	US26D	19.10	each

Above cylinder collars can be used with 4700 Series exit device trim and 1-1/8" - 1-3/8" long mortise cylinders.



2-649-0045 Cylinder Collar - 7/16" projection	US3	19.10	each
2-649-0046 Cylinder Collar - 7/16" projection	US4	19.10	each
2-649-0047 Cylinder Collar - 7/16" projection	US10	19.10	each
2-649-0048 Cylinder Collar - 7/16" projection	US10B	19.10	each
2-649-0050 Cylinder Collar - 7/16" projection	US26	19.10	each
2-649-0051 Cylinder Collar - 7/16" projection	US26D	19.10	each
2-649-0052 Cylinder Collar - 7/16" projection	US15 / US32D	19.10	each

Above cylinder collars can be used with 4500 Series exit device trim and 1-1/8" long mortise cylinders.





Cylinder Collars Description	Finish	2021 List	Box Qty.
2-649-0053 Cylinder Collar - 11/16" projection	US3	19.10	each
2-649-0054 Cylinder Collar - 11/16" projection	US4	19.10	each
2-649-0055 Cylinder Collar - 11/16" projection	US10	19.10	each
2-649-0056 Cylinder Collar - 11/16" projection	US10B	19.10	each
2-649-0057 Cylinder Collar - 11/16" projection	US26	19.10	each
2-649-0058 Cylinder Collar - 11/16" projection	US26D	19.10	each
2-649-0059 Cylinder Collar - 11/16" projection	US15 / US32D	19.10	each

Above cylinder collars can be used with 4500 Series exit device trim and 1-1/4" or 1-3/8" long mortise cylinders.

Cylinder Parts Description	Finish	2021 List
2-650-3998 SFIC Capping Strip		59.00/ per 50
2-639-7511 Pin Kit 100 each of all pins and springs, additional top pins. Please note that pin kit does NOT include SFIC caps.		345.00
2-639-7512 Cylinder Lubricant		50.00
2-639-7513 Shims Opens a locked conventional cylinder (at the workbench).		49.50/ per 100
2-639-7517 Construction Ball Used for lost ball construction keying. (#6 increment)		55.00/ per 1,000
2-650-3999 Cylinder Spring Pin tumbler spring for use in all cylinders.		6.60/ per 100
2-639-7519 Cap Pin Spring Key-in-Knob/Lever cylinders including Retrofit, and Full Size (Schlage Retrofit) Interchangeable Core.		15.00/ per 100
2-639-7520 Individual SFIC Cap For use with the individual capping block tool #6.		45.00/ per 500
2-639-7522 Profile Cylinder Set Screws Caps the profile cylinder chambers		7.00/ per 10
2-639-7523 Hager Screw Cap - (.280") height		15.00/ per 10



Locks - Cylinders/Keying

Cylinder Parts Description	Finish	2021 List
2-639-7526 Screw Cap Pin (KIK / LFIC)		15.00/ per 100
2-639-7527 Follower (KIK) Holds top pins in place during assembly or disassembly		19.00
2-639-7528 Tweezers		38.00
2-639-7530 Capping Punch		57.00
2-639-7531 Decombinating Block (punch included)		175.00
2-639-7532 Manual Capping Block (punch included) (140 Spacing)		218.90
2-639-7535 Key Punch (140 Spacing)		3,540.00
2-639-7536 HPC 1200 Series Code Card (140 Spacing)		38.50



Top Pins (Hager H Keyways) Description	2021 List
2-639-8188 #2 (0.025")	6.65/ per 100
2-639-8189 #3 (0.037")	6.65/ per 100
2-639-8190 #4 (0.050")	6.65/ per 100
2-639-8191 #5 (0.062")	6.65/ per 100
2-639-8192 #6 (0.075")	6.65/ per 100
2-639-8193 #7 (0.087")	6.65/ per 100
2-639-8194 #8 (0.100")	6.65/ per 100
2-639-8195 #9 (0.112")	6.65/ per 100
2-639-8196 #10 (0.125")	6.65/ per 100
2-639-8197 #11 (0.137")	6.65/ per 100
2-639-8198 #12 (0.150")	6.65/ per 100
2-639-8199 #13 (0.162")	6.65/ per 100
2-639-8200 #14 (0.175")	6.65/ per 100
2-639-8201 #15 (0.187")	6.65/ per 100
2-639-8202 #16 (0.200")	6.65/ per 100
2-639-8203 #17 (0.212")	6.65/ per 100
2-639-8204 #18 (0.225")	6.65/ per 100
2-639-8205 #19 (0.237")	6.65/ per 100



Locks - Full Bottom Pins

Full Bottom Pins (Hager H Keyways)	2021 List
Description	
2-639-8210 #0 (0.185")	6.65/ per 100
2-639-8211 #1 (0.1975")	6.65/ per 100
2-639-8212 #2 (0.210")	6.65/ per 100
2-639-8213 #3 (0.2225")	6.65/ per 100
2-639-8214 #4 (0.2350")	6.65/ per 100
2-639-8215 #5 (0.2475")	6.65/ per 100
2-639-8216 #6 (0.2600")	6.65/ per 100
2-639-8217 #7 (0.2725")	6.65/ per 100
2-639-8218 #8 (0.2850")	6.65/ per 100
2-639-8219 #9 (0.2975")	6.65/ per 100



SFIC Bottom Pins (Hager H Keyways) Description	2021 List
2-639-8220 #0 (0.110")	6.65/ per 100
2-639-8221 #1 (0.122")	6.65/ per 100
2-639-8222 #2 (0.135")	6.65/ per 100
2-639-8223 #3 (0.147")	6.65/ per 100
2-639-8224 #4 (0.160")	6.65/ per 100
2-639-8225 #5 (0.172")	6.65/ per 100
2-639-8226 #6 (0.185")	6.65/ per 100
2-639-8227 #7 (0.197")	6.65/ per 100
2-639-8228 #8 (0.210")	6.65/ per 100
2-639-8229 #9 (0.222")	6.65/ per 100



2310

2310 2-3/8" US10B JOS.....	.074356
2310 2-3/8" 10B JHN	184471
2310 2-3/8" 10B WRN091445
2310 2-3/8" 10B CHA	184214
2310 2-3/8" US15 JOS.....	174156
2310 2-3/8" US15 JHN.....	184578
2310 2-3/8" US15 WRN.....	108128
2310 2-3/8" US15 LOU	178281
2310 2-3/8" US15 CHA	192039
2310 2-3/8" US15 WRN.....	195686
2310 2-3/8" US15 LOU	139878
2310 2-3/8" US15 CHA	185419
2310 2-3/8" 26D JOS.....	179735
2310 2-3/8" 26D JHN	183038
2310 2-3/8" 26D WRN.....	176929
2310 2-3/8" 26D LOU040846
2310 2-3/8" 26D CHA	173293
2310 2 3/4" US10B JOS.....	169469
2310 2 3/4" US10B JHN.....	169738
2310 2 3/4" US10B WRN.....	169741
2310 2 3/4" US10B LOU	169744
2310 2 3/4" US10B CHA	169747
2310 2 3/4" US15 JOS.....	169686
2310 2 3/4" US15 JHN.....	169701
2310 2 3/4" US15 WRN.....	169709
2310 2 3/4" US15 LOU	169716
2310 2 3/4" US15 CHA	169722
2310 2 3/4" US26 JOS.....	169698
2310 2 3/4" US26 JHN.....	169737
2310 2 3/4" US26 WRN.....	169740
2310 2 3/4" US26 LOU	169743
2310 2 3/4" US26 CHA	169746
2310 2 3/4" US26D JOS.....	169453
2310 2 3/4" US26D JHN.....	169617
2310 2 3/4" US26D WRN.....	169622
2310 2 3/4" US26D LOU	169628
2310 2 3/4" US26D CHA	169631
2310 2 3/4" US3 JOS.....	169689
2310 2 3/4" US3 JHN.....	169704
2310 2 3/4" US3 WRN.....	169712
2310 2 3/4" US3 LOU	169718
2310 2 3/4" US3 CHA	169724
2310 2 3/4" US4 JOS.....	169695
2310 2 3/4" US4 JHN.....	169735
2310 2 3/4" US4 WRN.....	169739
2310 2 3/4" US4 LOU	169742
2310 2 3/4" US4 CHA	169745

2317

2317 US10B JOS	169754
2317 US10B JHN HL.....	171905
2317 US10B JHN RH.....	171906
2317 US10B WRN LH.....	171917
2317 US10B WRN RH.....	171918
2317 US10B LOU	169772
2317 US10B CHA.....	169778

2317

2317 US15 JOS.....	169748
2317 US15 JHN LH.....	171895
2317 US15 JHN RH.....	171896
2317 US15 WRN LH.....	171909
2317 US15 WRN RH.....	171910
2317 US15 LOU	169768
2317 US15 CHA	169774
2317 US26 JOS.....	169753
2317 US26 JHN LH.....	171902
2317 US26 JHN RH.....	171903
2317 US26 WRN LH.....	171915
2317 US26 WRN RH.....	171916
2317 US26 LOU	169771
2317 US26 CHA	169777
2317 US26D JOS	167921
2317 US26D JHN LH.....	171893
2317 US26D JHN RH.....	171894
2317 US26D WRN LH.....	171907
2317 US26D WRN RH.....	171908
2317 US26D LOU	169767
2317 US26D CHA.....	169773
2317 US3 JOS.....	169751
2317 US3 JHN LH.....	171897
2317 US3 JHN RH.....	171898
2317 US3 WRN LH.....	171911
2317 US3 WRN RH.....	171912
2317 US3 LOU	169769
2317 US3 CHA	169775
2317 US4 LOU	169770
2317 US4 CHA	169776
2317 US4 JOS.....	169752
2317 US4 JHN LH.....	171900
2317 US4 JHN RH.....	171901
2317 US4 WRN LH.....	171913
2317 US4 WRN RH.....	171914

2340

2340 2-3/8" US10B JOS.....	92146
2340 2-3/8" US10B JHN	80804
2340 2-3/8" US10B WRN.....	91422
2340 2-3/8" US10B LOU	51718
2340 2-3/8" US10B CHA	194638
2340 2-3/8" US15 JOS.....	174157
2340 2-3/8" US15 JHN.....	184579
2340 2-3/8" US15 WRN.....	108493
2340 2-3/8" US15 LOU	178282
2340 2-3/8" US15 CHA	193046
2340 2-3/8" US26 JOS.....	195688
2340 2-3/8" US26 JHN.....	139877
2340 2-3/8" US26 CHA	112917
2340 2-3/8" 26D JOS.....	175754
2340 2-3/8" US26D JHN	181458
2340 2-3/8" US26D WRN.....	193850
2340 2-3/8" US26D LOU	40825
2340 2-3/8" 26D CHA	173294
2340 2 3/4" US10B JOS.....	169471

Items with the price in **bold and red** are Quick Ship Items and ship in 24 hours.

2340

2340 2 3/4" US10B JHN	169819
2340 2 3/4" US10B WRN	169822
2340 2 3/4" US10B LOU	169825
2340 2 3/4" US10B CHA	169828
2340 2 3/4" US15 JOS	169688
2340 2 3/4" US15 JHN	169703
2340 2 3/4" US15 WRN	169711
2340 2 3/4" US15 LOU	169730
2340 2 3/4" US15 CHA	169732
2340 2 3/4" US26 JOS	169700
2340 2 3/4" US26 JHN	169818
2340 2 3/4" US26 WRN	169821
2340 2 3/4" US26 LOU	169824
2340 2 3/4" US26 CHA	169827
2340 2 3/4" US26D JOS	169455
2340 2 3/4" US26D JOS	169455
2340 2 3/4" US26D JHN	169619
2340 2 3/4" US26D WRN	169682
2340 2 3/4" US26D LOU	169729
2340 2 3/4" US26D CHA	169733
2340 2 3/4" US3 JOS	169694
2340 2 3/4" US3 JHN	169706
2340 2 3/4" US3 WRN	169728
2340 2 3/4" US3 LOU	169731
2340 2 3/4" US3 CHA	169734
2340 2 3/4" US4 JOS	169697
2340 2 3/4" US4 JHN	169817
2340 2 3/4" US4 WRN	169820
2340 2 3/4" US4 LOU	169823
2340 2 3/4" US4 CHA	169826

2510

2510 2-3/8" US10B ARC ASA	143873
2510 2-3/8" US10B WTN ASA	147186
2510 2-3/8" US26D ARC ASA	134474
2510 2-3/8" US26D WTN ASA	136277
2510 2-3/8" US3 ARC ASA	78572
2510 2-3/8" US3 WTN ASA	137318
2510 2-3/4" US10B ARC ASA	128993
2510 2-3/4" US10B WTN ASA	129000
2510 2-3/4" US26D ARC ASA	129001
2510 2-3/4" US26D WTN ASA	129002
2510 2-3/4" US3 ARC ASA	129003
2510 2-3/4" US3 WTN ASA	129004

2517

2517 US10B ARC	130785
2517 US10B WTN	130786
2517 US26D ARC	130787
2517 US26D WTN	130788
2517 US3 ARC	130789
2517 US3 WTN	130790

2525

2525 2-3/8" US10B ARC ASA	176278
2525 2-3/8" US10B WTN ASA	193167

2525

2525 2-3/8" US26D ARC ASA	156965
2525 2-3/8" US26D WTN ASA	147316
2525 2-3/8" US3 ARC ASA	196106
2525 2-3/8" US3 WTN ASA	167674
2525 2-3/4" US10B ARC ASA	129012
2525 2-3/4" US10B WTN ASA	129013
2525 2-3/4" US26D ARC ASA	129016
2525 2-3/4" US26D WTN ASA	129017
2525 2-3/4" US3 ARC ASA	129018
2525 2-3/4" US3 WTN ASA	129020

2540

2540 2-3/8" US10B ARC ASA	135767
2540 2-3/8" US10B WTN ASA	147189
2540 2-3/8" US26D ARC ASA	134473
2540 2-3/8" US26D WTN ASA	144640
2540 2-3/8" US3 WTN ASA	137317
2540 2-3/4" US10B ARC ASA	129021
2540 2-3/4" US10B WTN ASA	129022
2540 2-3/4" US26D ARC ASA	129023
2540 2-3/4" US26D WTN ASA	129024
2540 2-3/4" US3 ARC ASA	129025
2540 2-3/4" US3 WTN ASA	129026

2550

2550 2-3/8" US26D ARC SCC KD ASA	150263
2550 2-3/8" US26D WTN SCC KD ASA	148604
2550 2-3/4" US10B ARC SCC KD ASA	129637
2550 2-3/4" US10B ARC NC ASA IC	129032
2550 2-3/4" US10B WTN SCC KD ASA	129638
2550 2-3/4" US10B WTN NC ASA IC	129034
2550 2-3/4" US26D ARC SCC KD ASA	129639
2550 2-3/4" US26D ARC NC ASA IC	129036
2550 2-3/4" US26D WTN SCC KD ASA	129642
2550 2-3/4" US26D WTN NC ASA IC	129038
2550 2-3/4" US3 ARC SCC KD ASA	129643
2550 2-3/4" US3 WTN SCC KD ASA	129644

2553

2553 2-3/8" US10B ARC SCC KD ASA	140478
2553 2-3/8" US10B WTN SCC KD ASA	160465
2553 2-3/8" US26D ARC SCC KD ASA	134768
2553 2-3/8" US26D WTN SCC KD ASA	136279
2553 2-3/8" US3 ARC SCC KD ASA	163970
2553 2-3/8" US3 WTN SCC KD ASA	150220
2553 2-3/4" US10B ARC NC ASA IC	129046
2553 2-3/4" US10B ARC SCC KD ASA	129645
2553 2-3/4" US10B WTN NC ASA IC	129048
2553 2-3/4" US10B WTN SCC KD ASA	129646
2553 2-3/4" US26D ARC NC ASA IC	129053
2553 2-3/4" US26D ARC SCC KD ASA	129647
2553 2-3/4" US26D WTN NC ASA IC	129055
2553 2-3/4" US26D WTN SCC KD ASA	129648
2553 2-3/4" US3 ARC SCC KD ASA	129649
2553 2-3/4" US3 WTN SCC KD ASA	129650

Items with the price in **bold and red** are Quick Ship Items and ship in 24 hours.



2570

2570 2-3/8" US10B WTN SCC KD ASA	164364
2570 2-3/8" US26D WTN SCC KD ASA	143635
2570 2-3/8" US3 WTN SCC KD ASA	170761
2570 2-3/4" US10B ARC SCC KD ASA	129651
2570 2-3/4" US10B ARC NC ASA IC	129061
2570 2-3/4" US10B WTN SCC KD ASA	129652
2570 2-3/4" US10B WTN NC ASA IC	129063
2570 2-3/4" US26D ARC SCC KD ASA	129653
2570 2-3/4" US26D ARC NC ASA IC	129065
2570 2-3/4" US26D WTN SCC KD ASA	129654
2570 2-3/4" US26D WTN NC ASA IC	129068
2570 2-3/4" US3 ARC SCC KD ASA	129655
2570 2-3/4" US3 WTN SCC KD ASA	129656

2580

2580 2-3/8" US10B ARC SCC KD ASA	184569
2580 2-3/8" US10B WTN SCC KD ASA	151209
2580 2-3/8" US26D WTN SCC KD ASA	132617
2580 2-3/4" US10B ARC SCC KD ASA	129657
2580 2-3/4" US10B ARC NC ASA IC	129081
2580 2-3/4" US10B WTN SCC KD ASA	129658
2580 2-3/4" US10B WTN NC ASA IC	129085
2580 2-3/4" US26D ARC SCC KD ASA	129659
2580 2-3/4" US26D ARC NC ASA IC	129088
2580 2-3/4" US26D WTN SCC KD ASA	129660
2580 2-3/4" US26D WTN NC ASA IC	129092
2580 2-3/4" US3 ARC SCC KD ASA	129661
2580 2-3/4" US3 WTN SCC KD ASA	129662

3114

3114 2-3/4" US10 NC IC	.034812
3114 2-3/4" US10 SCC KD	.012596
3114 2-3/4" US10B NC IC	.034811
3114 2-3/4" US10B SCC KD	.012597
3114 2-3/4" US26 NC IC	.034810
3114 2-3/4" US26 SCC KD	.028119
3114 2-3/4" US26D NC IC	034807
3114 2-3/4" US26D SCC KD	028118
3114 2-3/4" US3 NC IC	.034815
3114 2-3/4" US3 SCC KD	.012594
3114 2-3/4" US4 NC IC	.034814
3114 2-3/4" US4 SCC KD	.012595

3115

3115 2-3/4" US10 NC IC	.040420
3115 2-3/4" US10 SCC KD	.012588
3115 2-3/4" US10B NC IC	.040418
3115 2-3/4" US10B SCC KD	.012592
3115 2-3/4" US26 NC IC	.040449
3115 2-3/4" US26 SCC KD	.028121
3115 2-3/4" US26D NC IC	098283
3115 2-3/4" US26D SCC KD	028120
3115 2-3/4" US3 NC IC	.040425
3115 2-3/4" US3 SCC KD	.012590
3115 2-3/4" US4 NC IC	.050868
3115 2-3/4" US4 SCC KD	.012589

Items with the price in **bold and red** are Quick Ship Items and ship in 24 hours.

3118

3118 2-3/4" US10 NC IC	.038894
3118 2-3/4" US10 SCC KD	.028133
3118 2-3/4" US10B NC IC	.038887
3118 2-3/4" US10B SCC KD	.050113
3118 2-3/4" US26 NC IC	.039335
3118 2-3/4" US26 SCC KD	.028126
3118 2-3/4" US26D NC IC	098282
3118 2-3/4" US26D SCC KD	028123
3118 2-3/4" US3 NC IC	.038920
3118 2-3/4" US3 SCC KD	.028129
3118 2-3/4" US4 NC IC	.038899
3118 2-3/4" US4 SCC KD	.028131

3214

3214 2-3/8" US10 SCC KD	.099243
3214 2-3/4" US10 NC IC	.034800
3214 2-3/4" US10 SCC KD	.012650
3214 2-3/8" US10B NC IC	.102016
3214 2-3/8" US10B SCC KD	.058093
3214 2-3/4" US10B NC IC	.034769
3214 2-3/4" US10B SCC KD	.012651
3214 2-3/8" US26D NC IC	.187062
3214 2-3/8" US26D SCC KD	.113487
3214 2-3/4" US26D NC IC	.034759
3214 2-3/4" US26D SCC KD	098342
3214 2-3/8" US3 NC IC	.148520
3214 2-3/8" US3 SCC KD	.044086
3214 2-3/4" US3 NC IC	.034803
3214 2-3/4" US3 SCC KD	.012647
3214 2-3/8" US32D SCC KD	.096051
3214 2-3/4" US32D NC IC	.034749
3214 2-3/4" US32D SCC KD	012645
3214 2-3/8" US4 SCC KD	.130567
3214 2-3/4" US4 NC IC	.034801
3214 2-3/4" US4 SCC KD	.012649

3215

3215 2-3/8" US10 NC IC	.136009
3215 2-3/8" US10 SCC KD	.054763
3215 2-3/4" US10 NC IC	.048992
3215 2-3/4" US10 SCC KD	.012653
3215 2-3/8" US10B NC IC	.007223
3215 2-3/8" US10B SCC KD	.097759
3215 2-3/4" US10B NC IC	.038848
3215 2-3/4" US10B SCC KD	012652
3215 2-3/8" US26D NC IC	.046832
3215 2-3/8" US26D SCC KD	.065836
3215 2-3/4" US26D NC IC	098280
3215 2-3/4" US26D SCC KD	098341
3215 2-3/8" US3 NC IC	.005743
3215 2-3/8" US3 SCC KD	.096177
3215 2-3/4" US3 NC IC	.084949
3215 2-3/4" US3 SCC KD	.012655
3215 2-3/8" US32D NC IC	.031595
3215 2-3/8" US32D SCC KD	.097015
3215 2-3/4" US32D NC IC	.098220
3215 2-3/4" US32D SCC KD	012657

3215

3215 2-3/8" US4 NC IC	.108489
3215 2-3/8" US4 SCC KD	.067222
3215 2-3/4" US4 NC IC	.038847
3215 2-3/4" US4 SCC KD	.012654

3216

3216 ADJ US10.	.143039
3216 ADJ US10B	.143040
3216 ADJ US26D	143041
3216 ADJ US3.	.143037
3216 ADJ US32D	.143043
3216 ADJ US4.	.143038

3220

3220 ADJ US10.	.111391
3220 ADJ US10B	.111392
3220 ADJ US26D	118136
3220 ADJ US3.	.111393
3220 ADJ US32D	.111395
3220 ADJ US4.	.111396

3221

3221 ADJ US10.	.111825
3221 ADJ US10B	.111832
3221 ADJ US26D	.118140
3221 ADJ US3.	.111833
3221 ADJ US32D	.111835
3221 ADJ US4.	.111837

3222

3222 ADJ US10.	.111415
3222 ADJ US10B	.111416
3222 ADJ US26D	.118139
3222 ADJ US3.	.111417
3222 ADJ US32D	.111419
3222 ADJ US4.	.111421

3410

3410 2-3/4" US10 ARC ASA	.012557
3410 2-3/4" US10 AUG ASA	.041178
3410 2-3/4" US10 WTN ASA	.012548
3410 2-3/4" US10B ARC ASA	.012560
3410 2-3/4" US10B AUG ASA	.041148
3410 2-3/4" US10B WTN ASA	.012549
3410 2-3/4" US26 ARC ASA	.012553
3410 2-3/4" US26 AUG ASA	.041141
3410 2-3/4" US26 WTN ASA	.012526
3410 2-3/4" US26D ARC ASA	012550
3410 2-3/4" US26D AUG ASA	041139
3410 2-3/4" US26D WTN ASA	012525
3410 2-3/4" US3 ARC ASA	.012554
3410 2-3/4" US3 AUG ASA	.041082
3410 2-3/4" US3 WTN ASA	.012528
3410 2-3/4" US4 ARC ASA	.012555
3410 2-3/4" US4 AUG ASA	.040960
3410 2-3/4" US4 WTN ASA	.012530

3417

3417 US10 ARC	.012576
3417 US10 AUG	.028522
3417 US10 WTN	.012569
3417 US10B ARC	.012577
3417 US10B AUG	.028542
3417 US10B WTN	.012570
3417 US26 ARC	.012572
3417 US26 AUG	.028516
3417 US26 WTN	.012566
3417 US26D ARC	.012571
3417 US26D AUG	.028530
3417 US26D WTN	012563
3417 US3 ARC	.012573
3417 US3 AUG	.028515
3417 US3 WTN	.012567
3417 US4 ARC	.012575
3417 US4 AUG	.028529
3417 US4 WTN	.012568

3440

3440 2-3/4" US10 ARC ASA	.012518
3440 2-3/4" US10 AUG ASA	.040751
3440 2-3/4" US10 WTN ASA	.012509
3440 2-3/4" US10B ARC ASA	.012519
3440 2-3/4" US10B AUG ASA	.040748
3440 2-3/4" US10B WTN ASA	.012510
3440 2-3/4" US26 ARC ASA	.012515
3440 2-3/4" US26 AUG ASA	.040718
3440 2-3/4" US26 WTN ASA	.012504
3440 2-3/4" US26D ARC ASA	012514
3440 2-3/4" US26D AUG ASA	040658
3440 2-3/4" US26D WTN ASA	012499
3440 2-3/4" US3 ARC ASA	.012516
3440 2-3/4" US3 APL ASA	.012502
3440 2-3/4" US3 AUG ASA	.040639
3440 2-3/4" US3 WTN ASA	.012505
3440 2-3/4" US32D APL ASA	.012503
3440 2-3/4" US4 ARC ASA	.012517
3440 2-3/4" US4 AUG ASA	.040618
3440 2-3/4" US4 WTN ASA	.012508

3450

3450 2-3/4" US10 ARC NC ASA IC	.038099
3450 2-3/4" US10 ARC SCC KD ASA	.038133
3450 2-3/4" US10 AUG NC ASA IC	.024940
3450 2-3/4" US10 AUG SCC KD ASA	.028445
3450 2-3/4" US10 WTN NC ASA IC	.038088
3450 2-3/4" US10 WTN SCC KD ASA	.038127
3450 2-3/4" US10B ARC LF ASA LFIC	.191995
3450 2-3/4" US10B ARC NC ASA IC	.038087
3450 2-3/4" US10B ARC SCC KD ASA	.038116
3450 2-3/4" US10B AUG LF ASA LFIC	.192006
3450 2-3/4" US10B AUG NC ASA IC	.024141
3450 2-3/4" US10B AUG SCC KD ASA	.028440
3450 2-3/4" US10B WTN LF ASA LFIC	.187523
3450 2-3/4" US10B WTN NC ASA IC	.038048
3450 2-3/4" US10B WTN SCC KD ASA	.038113

Items with the price in **bold and red** are Quick Ship Items and ship in 24 hours.



3450		3453	
3450 2-3/4" US26 ARC NC ASA IC	.038824	3453 2-3/4" US26D WTN NC ASA IC	.182636
3450 2-3/4" US26 ARC SCC KD ASA	.038170	3453 2-3/4" US26D WTN NC ASA IC	.098322
3450 2-3/4" US26 AUG NC ASA IC	.024933	3453 2-3/4" US26D WTN SCC KD ASA	.012427
3450 2-3/4" US26 AUG SCC KD ASA	.028439	3453 2-3/4" US3 ARC NC ASA IC	.038042
3450 2-3/4" US26 WTN NC ASA IC	.038823	3453 2-3/4" US3 ARC SCC KD ASA	.012440
3450 2-3/4" US26 WTN SCC KD ASA	.038169	3453 2-3/4" US3 AUG NC ASA IC	.024712
3450 2-3/4" US26D ARC LF ASA LFIC	.187489	3453 2-3/4" US3 AUG SCC KD ASA	.028389
3450 2-3/4" US26D ARC NC ASA IC	.098296	3453 2-3/4" US3 WTN NC ASA IC	.038040
3450 2-3/4" US26D ARC SCC KD ASA	.098330	3453 2-3/4" US3 WTN SCC KD ASA	.012433
3450 2-3/4" US26D AUG LF ASA LFIC	.191999	3453 2-3/4" US4 ARC NC ASA IC	.038018
3450 2-3/4" US26D AUG NC ASA IC	.024987	3453 2-3/4" US4 ARC SCC KD ASA	.012441
3450 2-3/4" US26D AUG SCC KD ASA	.028481	3453 2-3/4" US4 AUG NC ASA IC	.024616
3450 2-3/4" US26D WTN LF ASA LFIC	.182628	3453 2-3/4" US4 AUG SCC KD ASA	.028381
3450 2-3/4" US26D WTN NC ASA IC	.098323	3453 2-3/4" US4 WTN NC ASA IC	.037886
3450 2-3/4" US26D WTN SCC KD ASA	.098333	3453 2-3/4" US4 WTN SCC KD ASA	.012434
3450 2-3/4" US3 ARC NC ASA IC	.038539	3470	
3450 2-3/4" US3 ARC SCC KD ASA	.038167	3470 2-3/4" US10 ARC NC ASA IC	.144666
3450 2-3/4" US3 AUG NC ASA IC	.024928	3470 2-3/4" US10 ARC SCC KD ASA	.144670
3450 2-3/4" US3 AUG SCC KD ASA	.028431	3470 2-3/4" US10 AUG NC ASA IC	.144671
3450 2-3/4" US3 WTN NC ASA IC	.038293	3470 2-3/4" US10 AUG SCC KD ASA	.144672
3450 2-3/4" US3 WTN SCC KD ASA	.038140	3470 2-3/4" US10 WTN NC ASA IC	.144673
3450 2-3/4" US4 ARC NC ASA IC	.038135	3470 2-3/4" US10 WTN SCC KD ASA	.144674
3450 2-3/4" US4 ARC SCC KD ASA	.038139	3470 2-3/4" US10B ARC NC ASA IC	.144675
3450 2-3/4" US4 AUG NC ASA IC	.024949	3470 2-3/4" US10B ARC SCC KD ASA	.144676
3450 2-3/4" US4 AUG SCC KD ASA	.028446	3470 2-3/4" US10B AUG NC ASA IC	.144677
3450 2-3/4" US4 WTN NC ASA IC	.038112	3470 2-3/4" US10B AUG SCC KD ASA	.144678
3450 2-3/4" US4 WTN SCC KD ASA	.038134	3470 2-3/4" US10B WTN NC ASA IC	.144679
3453		3470 2-3/4" US10B WTN SCC KD ASA	.144680
3453 2-3/4" US10 ARC NC ASA IC	.037850	3470 2-3/4" US26 ARC NC ASA IC	.144683
3453 2-3/4" US10 ARC SCC KD ASA	.012442	3470 2-3/4" US26 ARC SCC KD ASA	.144684
3453 2-3/4" US10 AUG NC ASA IC	.024866	3470 2-3/4" US26 AUG SCC KD ASA	.144686
3453 2-3/4" US10 AUG SCC KD ASA	.028404	3470 2-3/4" US26 WTN NC ASA IC	.144687
3453 2-3/4" US10 WTN NC ASA IC	.037795	3470 2-3/4" US26 WTN SCC KD ASA	.144688
3453 2-3/4" US10 WTN SCC KD ASA	.012435	3470 2-3/4" US26D ARC NC ASA IC	.144689
3453 2-3/4" US10B ARC NC ASA IC	.192007	3470 2-3/4" US26D ARC SCC KD ASA	.144667
3453 2-3/4" US10B ARC NC ASA IC	.088953	3470 2-3/4" US26D AUG NC ASA IC	.144690
3453 2-3/4" US10B ARC SCC KD ASA	.012443	3470 2-3/4" US26D AUG SCC KD ASA	.144691
3453 2-3/4" US10B AUG NC ASA IC	.192017	3470 2-3/4" US26D WTN NC ASA IC	.144668
3453 2-3/4" US10B AUG NC ASA IC	.024855	3470 2-3/4" US26D WTN SCC KD ASA	.144669
3453 2-3/4" US10B AUG SCC KD ASA	.028393	3470 2-3/4" US3 ARC NC ASA IC	.144692
3453 2-3/4" US10B WTN NC ASA IC	.187551	3470 2-3/4" US3 ARC SCC KD ASA	.144694
3453 2-3/4" US10B WTN NC ASA IC	.037776	3470 2-3/4" US3 AUG NC ASA IC	.144696
3453 2-3/4" US10B WTN SCC KD ASA	.012437	3470 2-3/4" US3 AUG SCC KD ASA	.144697
3453 2-3/4" US26 ARC NC ASA IC	.038229	3470 2-3/4" US3 WTN NC ASA IC	.144698
3453 2-3/4" US26 ARC SCC KD ASA	.012439	3470 2-3/4" US3 WTN SCC KD ASA	.144699
3453 2-3/4" US26 AUG NC ASA IC	.024761	3470 2-3/4" US4 ARC NC ASA IC	.144702
3453 2-3/4" US26 AUG SCC KD ASA	.028391	3470 2-3/4" US4 ARC SCC KD ASA	.144703
3453 2-3/4" US26 WTN NC ASA IC	.038044	3470 2-3/4" US4 AUG SCC KD ASA	.144705
3453 2-3/4" US26 WTN SCC KD ASA	.012429	3470 2-3/4" US4 WTN NC ASA IC	.144706
3453 2-3/4" US26D ARC NC ASA IC	.187488	3470 2-3/4" US4 WTN SCC KD ASA	.144707
3453 2-3/4" US26D ARC NC ASA IC	.098295	3473	
3453 2-3/4" US26D ARC SCC KD ASA	.012438	3473 2-3/4" US10B ARC NC ASA IC (REV1)	.138470
3453 2-3/4" US26D AUG NC ASA IC	.192016	3473 2-3/4" US10B ARC SCC KD ASA (REV1)	.138471
3453 2-3/4" US26D AUG NC ASA IC	.024713	3473 2-3/4" US10B AUG NC ASA IC (REV1)	.138472
3453 2-3/4" US26D AUG SCC KD ASA	.028390	3473 2-3/4" US10B AUG SCC KD ASA (REV1)	.138473

Items with the price in **bold and red** are Quick Ship Items and ship in 24 hours.

3473

3473 2-3/4" US10B WTN NC ASA IC (REV1)	138474
3473 2-3/4" US26D ARC LF ASA LFIC (REV1)	187494
3473 2-3/4" US26D ARC NC ASA IC (REV1)	138482
3473 2-3/4" US26D ARC SCC KD ASA (REV1)	138485
3473 2-3/4" US26D AUG LF ASA LFIC (REV1)	37101
3473 2-3/4" US26D AUG NC ASA IC (REV1)	138487
3473 2-3/4" US26D AUG SCC KD ASA (REV1)	138488
3473 2-3/4" US26D WTN LF ASA LFIC (REV1)	182638
3473 2-3/4" US26D WTN NC ASA IC (REV1)	138489
3473 2-3/4" US26D WTN SCC KD ASA (REV1)	138490

3480

3480 2-3/4" US10 ARC NC ASA IC037343
3480 2-3/4" US10 ARC SCC KD ASA012495
3480 2-3/4" US10 AUG NC ASA IC024368
3480 2-3/4" US10 AUG SCC KD ASA028031
3480 2-3/4" US10 WTN NC ASA IC037330
3480 2-3/4" US10 WTN SCC KD ASA012483
3480 2-3/4" US10B ARC LF ASA LFIC192043
3480 2-3/4" US10B ARC NC ASA IC037326
3480 2-3/4" US10B ARC SCC KD ASA012496
3480 2-3/4" US10B AUG LF ASA LFIC192371
3480 2-3/4" US10B AUG NC ASA IC024348
3480 2-3/4" US10B AUG SCC KD ASA028017
3480 2-3/4" US10B WTN LF ASA LFIC187556
3480 2-3/4" US10B WTN NC ASA IC037325
3480 2-3/4" US10B WTN SCC KD ASA012490
3480 2-3/4" US26 ARC NC ASA IC038085
3480 2-3/4" US26 ARC SCC KD ASA012492
3480 2-3/4" US26 AUG NC ASA IC024328
3480 2-3/4" US26 AUG SCC KD ASA027994
3480 2-3/4" US26 WTN NC ASA IC037531
3480 2-3/4" US26 WTN SCC KD ASA012479
3480 2-3/4" US26D ARC NC ASA IC187498
3480 2-3/4" US26D ARC NC ASA IC	098292
3480 2 3/4 26D ARC SCC KD ASA	012491
3480 2-3/4" US26D AUG NC ASA IC024264
3480 2-3/4" US26D AUG SCC KD ASA	027993
3480 2-3/4" US26D WTN NC ASA IC182639
3480 2-3/4" US26D WTN NC ASA IC	098651
3480 2-3/4" US26D WTN SCC KD ASA	012478
3480 2-3/4" US3 ARC NC ASA IC037516
3480 2-3/4" US3 ARC SCC KD ASA012493
3480 2-3/4" US3 AUG NC ASA IC024233
3480 2-3/4" US3 AUG SCC KD ASA027990
3480 2-3/4" US3 WTN NC ASA IC037444
3480 2-3/4" US3 WTN SCC KD ASA012481
3480 2-3/4" US4 ARC NC ASA IC037408
3480 2-3/4" US4 ARC SCC KD ASA012494
3480 2-3/4" US4 AUG NC ASA IC024187
3480 2-3/4" US4 AUG SCC KD ASA027988
3480 2-3/4" US4 WTN NC ASA IC037388
3480 2-3/4" US4 WTN SCC KD ASA012482

3495

3495 2-3/4" US10 ARC NC ASA IC006810
3495 2-3/4" US10 ARC SCC KD ASA007195
3495 2-3/4" US10 AUG NC ASA IC006739
3495 2-3/4" US10 AUG SCC KD ASA006847
3495 2-3/4" US10 WTN NC ASA IC006765
3495 2-3/4" US10 WTN SCC KD ASA007081
3495 2-3/4" US10B ARC NC ASA IC006803
3495 2-3/4" US10B ARC SCC KD ASA007192
3495 2-3/4" US10B AUG NC ASA IC006738
3495 2-3/4" US10B AUG SCC KD ASA006846
3495 2-3/4" US10B WTN NC ASA IC006758
3495 2-3/4" US10B WTN SCC KD ASA007074
3495 2-3/4" US26 ARC NC ASA IC006798
3495 2-3/4" US26 ARC SCC KD ASA007182
3495 2-3/4" US26 AUG NC ASA IC006735
3495 2-3/4" US26 AUG SCC KD ASA006841
3495 2-3/4" US26 WTN NC ASA IC006754
3495 2-3/4" US26 WTN SCC KD ASA007071
3495 2-3/4" US26D ARC LF ASA LFIC187499
3495 2-3/4" US26D ARC NC ASA IC006797
3495 2-3/4" US26D ARC SCC KD ASA007180
3495 2-3/4" US26D AUG LF ASA LFIC111736
3495 2-3/4" US26D AUG NC ASA IC006705
3495 2-3/4" US26D AUG SCC KD ASA006840
3495 2-3/4" US26D WTN NLF ASA LFIC182640
3495 2-3/4" US26D WTN NC ASA IC006753
3495 2-3/4" US26D WTN SCC KD ASA	007070
3495 2-3/4" US3 ARC NC ASA IC007292
3495 2-3/4" US3 ARC SCC KD ASA007295
3495 2-3/4" US3 AUG NC ASA IC006745
3495 2-3/4" US3 AUG SCC KD ASA007063
3495 2-3/4" US3 WTN NC ASA IC006795
3495 2-3/4" US3 WTN SCC KD ASA007176
3495 2-3/4" US4 ARC NC ASA IC006819
3495 2-3/4" US4 ARC SCC KD ASA007199
3495 2-3/4" US4 AUG NC ASA IC006743
3495 2-3/4" US4 AUG SCC KD ASA006848
3495 2-3/4" US4 WTN NC ASA IC006792
3495 2-3/4" US4 WTN SCC KD ASA007170

34K

34K1 2-3/4" US10B ARC NC ASA IC194602
34K1 2-3/4" US10B ARC SCC KD ASA194600
34K1 2-3/4" US10B AUG NC ASA IC194606
34K1 2-3/4" US10B AUG SCC KD ASA194604
34K1 2-3/4" US10B AUG SCC KD ASA190236
34K1 2-3/4" US10B WTN SCC KD ASA190233
34K1 2-3/4" US26D ARC NC ASA IC (REV 1)37074
34K1 2-3/4" US26D ARC SCC KD ASA (REV 1)46486
34K1 2-3/4" US26D WTN NC ASA IC (REV 1)37076
34K1 2-3/4" US26D WTN SCC KD ASA (REV 1)46457
34K2 2-3/4" US10B ARC NC ASA IC95455
34K2 2-3/4" US10B ARC SCC KD ASA95473
34K2 2-3/4" US10B AUG NC ASA IC95437
34K2 2-3/4" US10B AUG SCC KD ASA95440

Items with the price in **bold and red** are Quick Ship Items and ship in 24 hours.



34K		3525	
34K2 2-3/4" US10B WTN NC ASA IC	191663	3525 2-3/4" US10B ARC ASA	.095546
34K2 2-3/4" US10B WTN SCC KD ASA	191659	3525 2-3/4" US10B AUG ASA	.038434
34K2 2-3/4" US26D ARC NC ASA IC	.95467	3525 2-3/4" US10B WTN ASA	.095537
34K2 2-3/4" US26D ARC SCC KD ASA	.95489	3525 2-3/4" US26 ARC ASA	.095547
34K2 2-3/4" US26D AUG NC ASA IC	.95438	3525 2-3/4" US26 AUG ASA	.038492
34K2 2-3/4" US26D AUG SCC KD ASA	.95444	3525 2-3/4" US26 WTN ASA	.095543
34K2 2-3/4" US26D WTN NC ASA IC	191660	3525 2-3/4" US26D ARC ASA	.095550
34K2 2-3/4" US26D WTN SCC KD ASA	191658	3525 2-3/4" US26D AUG ASA	.038430
3510		3525 2-3/4" US26D WTN ASA	
3510 2-3/4" US10 ARC ASA	.000319		095544
3510 2-3/4" US10 AUG ASA	.038966	3525 2-3/4" US3 ARC ASA	.095533
3510 2-3/4" US10 WTN ASA	.000261	3525 2-3/4" US3 AUG ASA	.038519
3510 2-3/4" US10B ARC ASA	000320	3525 2-3/4" US3 WTN ASA	.095532
3510 2-3/4" US10B AUG ASA	.037082	3525 2-3/4" US4 ARC ASA	.095534
3510 2-3/4" US10B WTN ASA	000262	3525 2-3/4" US4 AUG ASA	.038390
3510 2-3/4" US26 ARC ASA	.000316	3525 2-3/4" US4 WTN ASA	.095535
3510 2-3/4" US26 AUG ASA	.036933	3527	
3510 2-3/4" US26 WTN ASA	.000258	3527 US10 ARC	.111169
3510 2-3/4" US26D ARC ASA	000313	3527 US10 AUG	.111189
3510 2-3/4" US26D AUG ASA	036892	3527 US10 WTN	.111191
3510 2-3/4" US26D WTN ASA	000256	3527 US10B ARC	.111192
3510 2-3/4" US3 ARC ASA	.000317	3527 US10B AUG	.111193
3510 2-3/4" US3 AUG ASA	.036825	3527 US10B WTN	.111194
3510 2-3/4" US3 WTN ASA	.000259	3527 US26 ARC	.111195
3510 2-3/4" US4 ARC ASA	.000318	3527 US26 AUG	.111196
3510 2-3/4" US4 AUG ASA	.036813	3527 US26 WTN	.111197
3510 2-3/4" US4 WTN ASA	.000260	3527 US26D ARC	.111198
3510 2-3/4" US3 APL ASA	.091147	3527 US26D AUG	.111199
3510 2-3/4" US32D APL ASA	091148	3527 US26D WTN	.111200
3517		3527 US3 ARC	.111201
3517 US10 ARC	.000329	3527 US3 AUG	.111202
3517 US10 AUG	.027799	3527 US3 WTN	.111203
3517 US10 WTN	.000277	3527 US4 ARC	.111205
3517 US10B ARC	.111284	3527 US4 AUG	.111206
3517 US10B AUG	.111285	3527 US4 WTN	.111204
3517 US10B WTN	.111286	3540	
3517 US26 ARC	.000322	3540 2-3/4" US10 ARC ASA	.000311
3517 US26 AUG	.027791	3540 2-3/4" US10 AUG ASA	.038384
3517 US26 WTN	.111288	3540 2-3/4" US10 WTN ASA	.000252
3517 US26D ARC	111289	3540 2-3/4" US10B ARC ASA	000312
3517 US26D AUG	111290	3540 2-3/4" US10B AUG ASA	.038280
3517 US26D WTN	111291	3540 2-3/4" US10B WTN ASA	000254
3517 US3 ARC	.000323	3540 2-3/4" US26 ARC ASA	.000308
3517 US3 AUG	.027775	3540 2-3/4" US26 AUG ASA	.038266
3517 US3 WTN	.111294	3540 2-3/4" US26 WTN ASA	.000248
3517 US4 ARC	.000325	3540 2-3/4" US26D ARC ASA	000307
3517 US4 AUG	.027768	3540 2-3/4" US26D AUG ASA	038034
3517 US4 WTN	.000276	3540 2-3/4" US26D WTN ASA	000247
3517 US3 APL	.000102	3540 2-3/4" US3 ARC ASA	.000309
3517 US32D APL	.000105	3540 2-3/4" US3 AUG ASA	.037999
3525		3540 2-3/4" US3 WTN ASA	.000249
3525 2-3/4" US10 ARC ASA	.095545	3540 2-3/4" US4 ARC ASA	.000310
3525 2-3/4" US10 AUG ASA	.038501	3540 2-3/4" US4 AUG ASA	.037979
3525 2-3/4" US10 WTN ASA	.095536	3540 2-3/4" US4 WTN ASA	.000250
		3540 2-3/4" US3 APL ASA	.091121
		3540 2-3/4" US32D APL ASA	091146

Items with the price in bold and red are Quick Ship Items and ship in 24 hours.

3550

3550 2-3/4" US10 ARC NC ASA IC	.037229
3550 2-3/4" US10 ARC SCC KD ASA	.037173
3550 2-3/4" US10 AUG NC ASA IC	.023439
3550 2-3/4" US10 AUG SCC KD ASA	.027728
3550 2-3/4" US10 WTN NC ASA IC	.037227
3550 2-3/4" US10 WTN SCC KD ASA	.037170
3550 2-3/4" US10B ARC NC ASA IC	.037208
3550 2-3/4" US10B ARC SCC KD ASA	.037169
3550 2-3/4" US10B AUG NC ASA IC	.023588
3550 2-3/4" US10B AUG SCC KD ASA	.027729
3550 2-3/4" US10B WTN NC ASA IC	.037206
3550 2-3/4" US10B WTN SCC KD ASA	.037162
3550 2-3/4" US26 ARC NC ASA IC	.038039
3550 2-3/4" US26 ARC SCC KD ASA	.037205
3550 2-3/4" US26 AUG NC ASA IC	.023554
3550 2-3/4" US26 AUG SCC KD ASA	.027726
3550 2-3/4" US26 WTN NC ASA IC	.037256
3550 2-3/4" US26 WTN SCC KD ASA	.037203
3550 2-3/4" US26D ARC NC ASA IC	.098290
3550 2-3/4" US26D ARC SCC KD ASA	.098325
3550 2-3/4" US26D AUG NC ASA IC	.023493
3550 2-3/4" US26D AUG SCC KD ASA	.027719
3550 2-3/4" US26D WTN NC ASA IC	.098291
3550 2-3/4" US26D WTN SCC KD ASA	.098329
3550 2-3/4" US3 ARC NC ASA IC	.037245
3550 2-3/4" US3 ARC SCC KD ASA	.050365
3550 2-3/4" US3 AUG NC ASA IC	.023438
3550 2-3/4" US3 AUG SCC KD ASA	.027713
3550 2-3/4" US3 WTN NC ASA IC	.037234
3550 2-3/4" US3 WTN SCC KD ASA	.037202
3550 2-3/4" US4 ARC NC ASA IC	.037232
3550 2-3/4" US4 ARC SCC KD ASA	.037200
3550 2-3/4" US4 AUG NC ASA IC	.023453
3550 2-3/4" US4 AUG SCC KD ASA	.027704
3550 2-3/4" US4 WTN NC ASA IC	.037230
3550 2-3/4" US4 WTN SCC KD ASA	.037191

3553

3553 2-3/4" US10 ARC NC ASA IC	.048993
3553 2-3/4" US10 ARC SCC KD ASA	.000290
3553 2-3/4" US10 AUG NC ASA IC	.023437
3553 2-3/4" US10 AUG SCC KD ASA	.027702
3553 2-3/4" US10 WTN NC ASA IC	.037888
3553 2-3/4" US10 WTN SCC KD ASA	.000095
3553 2-3/4" US10B ARC NC ASA IC	.037159
3553 2-3/4" US10B ARC SCC KD ASA	.000291
3553 2-3/4" US10B AUG NC ASA IC	.023436
3553 2-3/4" US10B AUG SCC KD ASA	.027701
3553 2-3/4" US10B WTN NC ASA IC	.045784
3553 2-3/4" US10B WTN SCC KD ASA	.000096
3553 2-3/4" US26 ARC NC ASA IC	.161159
3553 2-3/4" US26 ARC SCC KD ASA	.000286
3553 2-3/4" US26 AUG NC ASA IC	.023435
3553 2-3/4" US26 AUG SCC KD ASA	.027684
3553 2-3/4" US26 WTN NC ASA IC	.014395
3553 2-3/4" US26 WTN SCC KD ASA	.000092

3553

3553 2-3/4" US26D ARC NC ASA IC	.098289
3553 2-3/4" US26D ARC SCC KD ASA	.000284
3553 2-3/4" US26D AUG NC ASA IC	.023393
3553 2-3/4" US26D AUG SCC KD ASA	.027683
3553 2-3/4" US26D WTN NC ASA IC	.098655
3553 2-3/4" US26D WTN SCC KD ASA	.000091
3553 2-3/4" US3 ARC NC ASA IC	.053986
3553 2-3/4" US3 ARC SCC KD ASA	.000288
3553 2-3/4" US3 AUG NC ASA IC	.023377
3553 2-3/4" US3 AUG SCC KD ASA	.027682
3553 2-3/4" US3 WTN NC ASA IC	.084942
3553 2-3/4" US3 WTN SCC KD ASA	.000093
3553 2-3/4" US4 ARC NC ASA IC	.086632
3553 2-3/4" US4 ARC SCC KD ASA	.000289
3553 2-3/4" US4 AUG NC ASA IC	.023296
3553 2-3/4" US4 AUG SCC KD ASA	.027677
3553 2-3/4" US4 WTN NC ASA IC	.037153
3553 2-3/4" US4 WTN SCC KD ASA	.000094
3553 2-3/4" US3 APL SCC KD ASA	.090526
3553 2-3/4" US32D APL NC ASA IC	.117596
3553 2-3/4" US32D APL SCC KD ASA	.091096

3570

3570 2-3/4" US10 ARC NC ASA IC	.144716
3570 2-3/4" US10 ARC SCC KD ASA	.144417
3570 2-3/4" US10 AUG SCC KD ASA	.144719
3570 2-3/4" US10 WTN NC ASA IC	.144720
3570 2-3/4" US10 WTN SCC KD ASA	.144721
3570 2-3/4" US10B ARC NC ASA IC	.144722
3570 2-3/4" US10B ARC SCC KD ASA	.144723
3570 2-3/4" US10B AUG NC ASA IC	.144724
3570 2-3/4" US10B AUG SCC KD ASA	.144725
3570 2-3/4" US10B WTN NC ASA IC	.144726
3570 2-3/4" US10B WTN SCC KD ASA	.144711
3570 2-3/4" US26 ARC SCC KD ASA	.144728
3570 2-3/4" US26 AUG NC ASA IC	.144729
3570 2-3/4" US26 AUG SCC KD ASA	.144730
3570 2-3/4" US26 WTN NC ASA IC	.144731
3570 2-3/4" US26 WTN SCC KD ASA	.144732
3570 2-3/4" US26D ARC NC ASA IC	.144734
3570 2-3/4" US26D ARC SCC KD ASA	.144712
3570 2-3/4" US26D AUG NC ASA IC	.144735
3570 2-3/4" US26D AUG SCC KD ASA	.144736
3570 2-3/4" US26D WTN NC ASA IC	.144713
3570 2-3/4" US26D WTN SCC KD ASA	.144714
3570 2-3/4" US3 ARC NC ASA IC	.144737
3570 2-3/4" US3 ARC SCC KD ASA	.144738
3570 2-3/4" US3 AUG NC ASA IC	.144740
3570 2-3/4" US3 AUG SCC KD ASA	.144741
3570 2-3/4" US3 WTN NC ASA IC	.144742
3570 2-3/4" US3 WTN SCC KD ASA	.144743
3570 2-3/4" US4 ARC NC ASA IC	.144744
3570 2-3/4" US4 ARC SCC KD ASA	.144745
3570 2-3/4" US4 AUG NC ASA IC	.144746
3570 2-3/4" US4 AUG SCC KD ASA	.144747
3570 2-3/4" US4 WTN NC ASA IC	.97056

Items with the price in **bold and red** are Quick Ship Items and ship in 24 hours.

3570

3570 2-3/4" US4 WTN SCC KD ASA	144749
3570 2-3/4" US3 APL SCC KD ASA	144739

3570 2-3/4" US32D APL SCC KD ASA 144715

3573

3573 2-3/4" US10 ARC NC ASA IC (REV1)	138416
3573 2-3/4" US10 ARC SCC KD ASA (REV1)	138417
3573 2-3/4" US10 AUG NC ASA IC (REV1)	138418
3573 2-3/4" US10 AUG SCC KD ASA (REV1)	138419
3573 2-3/4" US10 WTN NC ASA IC (REV1)	138420
3573 2-3/4" US10 WTN SCC KD ASA (REV1)	138421
3573 2-3/4" US10B ARC NC ASA IC (REV1)	138422
3573 2-3/4" US10B ARC SCC KD ASA (REV1)	138423
3573 2-3/4" US10B AUG NC ASA IC (REV1)	138424
3573 2-3/4" US10B AUG SCC KD ASA (REV1)	138426
3573 2-3/4" US10B WTN NC ASA IC (REV1)	138427
3573 2-3/4" US10B WTN SCC KD ASA (REV1)	138428
3573 2-3/4" US26 ARC NC ASA IC (REV1)	138429
3573 2-3/4" US26 ARC SCC KD ASA (REV1)	138430
3573 2-3/4" US26 AUG NC ASA IC (REV1)	138431
3573 2-3/4" US26 AUG SCC KD ASA (REV1)	138432
3573 2-3/4" US26 WTN NC ASA IC (REV1)	138433
3573 2-3/4" US26 WTN SCC KD ASA (REV1)	138434
3573 2-3/4" US26D ARC NC ASA IC (REV1)	138405
3573 2-3/4" US26D ARC SCC KD ASA (REV1)	138435
3573 2-3/4" US26D AUG NC ASA IC (REV1)	138407
3573 2-3/4" US26D AUG SCC KD ASA (REV1)	138409
3573 2-3/4" US26D WTN NC ASA IC (REV1)	138441
3573 2-3/4" US26D WTN SCC KD ASA (REV1)	138412
3573 2-3/4" US3 ARC NC ASA IC (REV1)	138448
3573 2-3/4" US3 ARC SCC KD ASA (REV1)	138449
3573 2-3/4" US3 AUG NC ASA IC (REV1)	138450
3573 2-3/4" US3 AUG SCC KD ASA (REV1)	138452
3573 2-3/4" US3 WTN NC ASA IC (REV1)	138453
3573 2-3/4" US3 WTN SCC KD ASA (REV1)	138454
3573 2-3/4" US4 ARC NC ASA IC (REV1)	138455
3573 2-3/4" US4 ARC SCC KD ASA (REV1)	138456
3573 2-3/4" US4 AUG NC ASA IC (REV1)	138457
3573 2-3/4" US4 AUG SCC KD ASA (REV1)	138458
3573 2-3/4" US4 WTN NC ASA IC (REV1)	138459
3573 2-3/4" US4 WTN SCC KD ASA (REV1)	138460

3579

3579 2-3/4" US10 ARC SCC KD ASA	095564
3579 2-3/4" US10 AUG NC ASA IC	023240
3579 2-3/4" US10 AUG SCC KD ASA	027417
3579 2-3/4" US10 WTN SCC KD ASA	095555
3579 2-3/4" US10B ARC SCC KD ASA	095563
3579 2-3/4" US10B AUG NC ASA IC	023129
3579 2-3/4" US10B AUG SCC KD ASA	027411
3579 2-3/4" US10B WTN NC ASA IC	100241
3579 2-3/4" US10B WTN SCC KD ASA	095556
3579 2-3/4" US26 ARC SCC KD ASA	095560
3579 2-3/4" US26 AUG NC ASA IC	023053
3579 2-3/4" US26 AUG SCC KD ASA	027410
3579 2-3/4" US26 WTN SCC KD ASA	095557
3579 2-3/4" US26D ARC NC ASA IC	098284

Items with the price in **bold and red** are Quick Ship Items and ship in 24 hours.



3579

3579 2-3/4" US26D ARC SCC KD ASA	095559
3579 2-3/4" US26D AUG NC ASA IC	023041
3579 2-3/4" US26D AUG SCC KD ASA	027408
3579 2-3/4" US26D WTN NC ASA IC	098285
3579 2-3/4" US26D WTN SCC KD ASA	095558
3579 2-3/4" US3 ARC SCC KD ASA	095566
3579 2-3/4" US3 AUG NC ASA IC	022986
3579 2-3/4" US3 AUG SCC KD ASA	027420
3579 2-3/4" US3 WTN SCC KD ASA	095552
3579 2-3/4" US4 ARC SCC KD ASA	095565
3579 2-3/4" US4 AUG NC ASA IC	023241
3579 2-3/4" US4 AUG SCC KD ASA	027421
3579 2-3/4" US4 WTN SCC KD ASA	095553

3580

3580 2-3/4" US10 ARC NC ASA IC	037088
3580 2-3/4" US10 ARC SCC KD ASA	000305
3580 2-3/4" US10 AUG NC ASA IC	022937
3580 2-3/4" US10 AUG SCC KD ASA	027351
3580 2-3/4" US10 WTN NC ASA IC	037034
3580 2-3/4" US10 WTN SCC KD ASA	000156
3580 2-3/4" US10B ARC NC ASA IC	037031
3580 2-3/4" US10B ARC SCC KD ASA	000306
3580 2-3/4" US10B AUG NC ASA IC	022831
3580 2-3/4" US10B AUG SCC KD ASA	027349
3580 2-3/4" US10B WTN NC ASA IC	037018
3580 2-3/4" US10B WTN SCC KD ASA	000160
3580 2-3/4" US26 ARC NC ASA IC	037752
3580 2-3/4" US26 ARC SCC KD ASA	000301
3580 2-3/4" US26 AUG NC ASA IC	022737
3580 2-3/4" US26 AUG SCC KD ASA	027347
3580 2-3/4" US26 WTN NC ASA IC	037103
3580 2-3/4" US26 WTN SCC KD ASA	000144
3580 2-3/4" US26D ARC NC ASA IC	098286
3580 2-3/4" US26D ARC SCC KD ASA	000300
3580 2-3/4" US26D AUG NC ASA IC	022700
3580 2-3/4" US26D AUG SCC KD ASA	027338
3580 2-3/4" US26D WTN NC ASA IC	098652
3580 2-3/4" US26D WTN SCC KD ASA	000143
3580 2-3/4" US3 ARC NC ASA IC	037098
3580 2-3/4" US3 ARC SCC KD ASA	000302
3580 2-3/4" US3 AUG NC ASA IC	022615
3580 2-3/4" US3 AUG SCC KD ASA	027337
3580 2-3/4" US3 WTN NC ASA IC	084892
3580 2-3/4" US3 WTN SCC KD ASA	000154
3580 2-3/4" US4 ARC NC ASA IC	086636
3580 2-3/4" US4 ARC SCC KD ASA	000303
3580 2-3/4" US4 AUG NC ASA IC	022602
3580 2-3/4" US4 AUG SCC KD ASA	027328
3580 2-3/4" US4 WTN NC ASA IC	037089
3580 2-3/4" US4 WTN SCC KD ASA	000155
3580 2-3/4" US3 APL SCC KD ASA	090565
3580 2-3/4" US32D APL SCC KD ASA	091101

3610

3610 ADJ 2-3/8 TO 2-3/4 US10 ARC ASA	092398
3610 ADJ 2-3/8 TO 2-3/4 US10 AUG ASA	027301

3610

3610 ADJ 2-3/8 TO 2-3/4 US10 WTN ASA092402
3610 ADJ 2-3/8 TO 2-3/4 US10B ARC ASA092404
3610 ADJ 2-3/8 TO 2-3/4 US10B AUG ASA027299
3610 ADJ 2-3/8 TO 2-3/4 US10B WTN ASA092403
3610 ADJ 2-3/8 TO 2-3/4 US26 ARC ASA092406
3610 ADJ 2-3/8 TO 2-3/4 US26 AUG ASA027295
3610 ADJ 2-3/8 TO 2-3/4 US26 WTN ASA092405
3610 ADJ 2-3/8 TO 2-3/4 US26D ARC ASA	092408
3610 ADJ 2-3/8 TO 2-3/4 US26D AUG ASA027294
3610 ADJ 2-3/8 TO 2-3/4 US26D WTN ASA	092410
3610 ADJ 2-3/8 TO 2-3/4 US3 ARC ASA092416
3610 ADJ 2-3/8 TO 2-3/4 US3 AUG ASA027292
3610 ADJ 2-3/8 TO 2-3/4 US3 WTN ASA092411
3610 ADJ 2-3/8 TO 2-3/4 US4 ARC ASA092418
3610 ADJ 2-3/8 TO 2-3/4 US4 AUG ASA027291
3610 ADJ 2-3/8 TO 2-3/4 US4 WTN ASA092419

3617

3617 US10 ARC013176
3617 US10 AUG027277
3617 US10 WTN013170
3617 US10B ARC013175
3617 US10B AUG027275
3617 US10B WTN013169
3617 US26 ARC013172
3617 US26 AUG027276
3617 US26 WTN013166
3617 US26D ARC	013171
3617 US26D AUG027272
3617 US26D WTN	013165
3617 US3 ARC013173
3617 US3 AUG027262
3617 US3 WTN013167
3617 US4 ARC013174
3617 US4 AUG027278
3617 US4 WTN013168

3640

3640 ADJ 2-3/8 TO 2-3/4 US10 ARC ASA092422
3640 ADJ 2-3/8 TO 2-3/4 US10 AUG ASA027238
3640 ADJ 2-3/8 TO 2-3/4 US10 WTN ASA092421
3640 ADJ 2-3/8 TO 2-3/4 US10B ARC ASA092423
3640 ADJ 2-3/8 TO 2-3/4 US10B AUG ASA027232
3640 ADJ 2-3/8 TO 2-3/4 US10B WTN ASA092424
3640 ADJ 2-3/8 TO 2-3/4 US26 ARC ASA092428
3640 ADJ 2-3/8 TO 2-3/4 US26 AUG ASA027230
3640 ADJ 2-3/8 TO 2-3/4 US26 WTN ASA092427
3640 ADJ 2-3/8 TO 2-3/4 US26D ARC ASA	092429
3640 ADJ 2-3/8 TO 2-3/4 US26D AUG ASA027229
3640 ADJ 2-3/8 TO 2-3/4 US26D WTN ASA	092430
3640 ADJ 2-3/8 TO 2-3/4 US3 ARC ASA092431
3640 ADJ 2-3/8 TO 2-3/4 US3 AUG ASA027227
3640 ADJ 2-3/8 TO 2-3/4 US3 WTN ASA092433
3640 ADJ 2-3/8 TO 2-3/4 US4 ARC ASA092435
3640 ADJ 2-3/8 TO 2-3/4 US4 AUG ASA027225
3640 ADJ 2-3/8 TO 2-3/4 US4 WTN ASA092434

3653

3653 ADJ 2-3/8 TO 2-3/4 US10 ARC NC ASA IC193999
3653 ADJ 2-3/8 TO 2-3/4 US10 ARC SCC KD ASA092436
3653 ADJ 2-3/8 TO 2-3/4 US10 AUG NC ASA IC194000
3653 ADJ 2-3/8 TO 2-3/4 US10 AUG SCC KD ASA026938
3653 ADJ 2-3/8 TO 2-3/4 US10 WTN NC ASA IC194001
3653 ADJ 2-3/8 TO 2-3/4 US10 WTN SCC KD ASA092439
3653 ADJ 2-3/8 TO 2-3/4 US10B ARC NC ASA IC194003
3653 ADJ 2-3/8 TO 2-3/4 US10B ARC SCC KD ASA092440
3653 ADJ 2-3/8 TO 2-3/4 US10B AUG NC ASA IC194005
3653 ADJ 2-3/8 TO 2-3/4 US10B AUG SCC KD ASA026695
3653 ADJ 2-3/8 TO 2-3/4 US10B WTN NC ASA IC194007
3653 ADJ 2-3/8 TO 2-3/4 US10B WTN SCC KD ASA092452
3653 ADJ 2-3/8 TO 2-3/4 US26 ARC NC ASA IC194011
3653 ADJ 2-3/8 TO 2-3/4 US26 ARC SCC KD ASA092442
3653 ADJ 2-3/8 TO 2-3/4 US26 AUG NC ASA IC194015
3653 ADJ 2-3/8 TO 2-3/4 US26 AUG SCC KD ASA026868
3653 ADJ 2-3/8 TO 2-3/4 US26 WTN NC ASA IC194016
3653 ADJ 2-3/8 TO 2-3/4 US26 WTN SCC KD ASA092450
3653 ADJ 2-3/8 TO 2-3/4 US26D ARC NC ASA IC194023
3653 ADJ 2-3/8 TO 2-3/4 US26D ARC SCC KD ASA	092443
3653 ADJ 2-3/8 TO 2-3/4 US26D AUG NC ASA IC194027
3653 ADJ 2-3/8 TO 2-3/4 US26D AUG SCC KD ASA026836
3653 ADJ 2-3/8 TO 2-3/4 US26D WTN NC ASA IC194031
3653 ADJ 2-3/8 TO 2-3/4 US26D WTN SCC KD ASA	092449
3653 ADJ 2-3/8 TO 2-3/4 US3 ARC NC ASA IC194037
3653 ADJ 2-3/8 TO 2-3/4 US3 ARC SCC KD ASA092444
3653 ADJ 2-3/8 TO 2-3/4 US3 AUG NC ASA IC194038
3653 ADJ 2-3/8 TO 2-3/4 US3 AUG SCC KD ASA026788
3653 ADJ 2-3/8 TO 2-3/4 US3 WTN NC ASA IC194039
3653 ADJ 2-3/8 TO 2-3/4 US3 WTN SCC KD ASA092447
3653 ADJ 2-3/8 TO 2-3/4 US4 ARC NC ASA IC194040
3653 ADJ 2-3/8 TO 2-3/4 US4 ARC SCC KD ASA092445
3653 ADJ 2-3/8 TO 2-3/4 US4 AUG NC ASA IC194042
3653 ADJ 2-3/8 TO 2-3/4 US4 AUG SCC KD ASA026834
3653 ADJ 2-3/8 TO 2-3/4 US4 WTN NC ASA IC194044
3653 ADJ 2-3/8 TO 2-3/4 US4 WTN SCC KD ASA092446

3670

3670 ADJ 2-3/8 - 2-3/4 US10 ARC NC ASA IC127307
3670 ADJ 2-3/8 - 2-3/4 US10 ARC SCC KD ASA127308
3670 ADJ 2-3/8 - 2-3/4 US10 AUG NC ASA IC127309
3670 ADJ 2-3/8 - 2-3/4 US10 AUG SCC KD ASA127310
3670 ADJ 2-3/8 - 2-3/4 US10 WTN NC ASA IC127311
3670 ADJ 2-3/8 - 2-3/4 US10 WTN SCC KD ASA127312
3670 ADJ 2-3/8 - 2-3/4 US10B ARC NC ASA IC127291
3670 ADJ 2-3/8 - 2-3/4 US10B ARC SCC KD ASA127292
3670 ADJ 2-3/8 - 2-3/4 US10B AUG NC ASA IC127293
3670 ADJ 2-3/8 - 2-3/4 US10B AUG SCC KD ASA127294
3670 ADJ 2-3/8 - 2-3/4 US10B WTN NC ASA IC127295
3670 ADJ 2-3/8 - 2-3/4 US10B WTN SCC KD ASA127296
3670 ADJ 2-3/8 - 2-3/4 US26 ARC NC ASA IC127313
3670 ADJ 2-3/8 - 2-3/4 US26 ARC SCC KD ASA127314
3670 ADJ 2-3/8 - 2-3/4 US26 AUG NC ASA IC127315
3670 ADJ 2-3/8 - 2-3/4 US26 AUG SCC KD ASA127316
3670 ADJ 2-3/8 - 2-3/4 US26 WTN NC ASA IC127317
3670 ADJ 2-3/8 - 2-3/4 US26 WTN SCC KD ASA127318
3670 ADJ 2-3/8 - 2-3/4 US26D ARC NC ASA IC127279

Items with the price in **bold and red** are Quick Ship Items and ship in 24 hours.



3670

3670 ADJ 2-3/8 TO 2-3/4 US26D ARC SCC KD ASA	127280
3670 ADJ 2-3/8" - 2-3/4" US26D AUG NC ASA IC	127281
3670 ADJ 2-3/8" - 2-3/4" US26D AUG SCC KD ASA	127282
3670 ADJ 2-3/8" - 2-3/4" US26D WTN NC ASA IC	127283
3670 ADJ 2-3/8 - 2-3/4 US26D WTN SCC KD ASA	127284
3670 ADJ 2-3/8" - 2-3/4" US3 ARC NC ASA IC	127319
3670 ADJ 2-3/8" - 2-3/4" US3 ARC SCC KD ASA	127320
3670 ADJ 2-3/8" - 2-3/4" US3 AUG NC ASA IC	127321
3670 ADJ 2-3/8" - 2-3/4" US3 AUG SCC KD ASA	127322
3670 ADJ 2-3/8" - 2-3/4" US3 WTN NC ASA IC	127323
3670 ADJ 2-3/8" - 2-3/4" US3 WTN SCC KD ASA	127324
3670 ADJ 2-3/8" - 2-3/4" US4 ARC NC ASA IC	127325
3670 ADJ 2-3/8" - 2-3/4" US4 ARC SCC KD ASA	127326
3670 ADJ 2-3/8" - 2-3/4" US4 AUG NC ASA IC	127327
3670 ADJ 2-3/8" - 2-3/4" US4 AUG SCC KD ASA	127328
3670 ADJ 2-3/8" - 2-3/4" US4 WTN NC ASA IC	127329
3670 ADJ 2-3/8" - 2-3/4" US4 WTN SCC KD ASA	127330

3680

3680 ADJ 2-3/8" - 2-3/4" US10 ARC NC ASA IC	194114
3680 ADJ 2-3/8" - 2-3/4" US10 ARC SCC KD ASA	127332
3680 ADJ 2-3/8" - 2-3/4" US10 AUG NC ASA IC	194115
3680 ADJ 2-3/8" - 2-3/4" US10 AUG SCC KD ASA	127334
3680 ADJ 2-3/8" - 2-3/4" US10 WTN NC ASA IC	194116
3680 ADJ 2-3/8" - 2-3/4" US10 WTN SCC KD ASA	127336
3680 ADJ 2-3/8" - 2-3/4" US10B ARC NC ASA IC	194117
3680 ADJ 2-3/8" - 2-3/4" US10B ARC SCC KD ASA	127298
3680 ADJ 2-3/8" - 2-3/4" US10B AUG NC ASA IC	194118
3680 ADJ 2-3/8" - 2-3/4" US10B AUG SCC KD ASA	127300
3680 ADJ 2-3/8" - 2-3/4" US10B WTN NC ASA IC	194119
3680 ADJ 2-3/8" - 2/3/4" US10B WTN SCC KD ASA	127302
3680 ADJ 2-3/8" - 2-3/4" US26 ARC NC ASA IC	194120
3680 ADJ 2-3/8" - 2-3/4" US26 ARC SCC KD ASA	127338
3680 ADJ 2-3/8" - 2-3/4" US26 AUG NC ASA IC	194121
3680 ADJ 2-3/8" - 2-3/4" US26 AUG SCC KD ASA	127340
3680 ADJ 2-3/8" - 2-3/4" US26 WTN NC ASA IC	194122
3680 ADJ 2-3/8" - 2-3/4" US26 WTN SCC KD ASA	127342
3680 ADJ 2-3/8" - 2-3/4" US26D ARC NC ASA IC	194123
3680 ADJ 2-3/8 - 2-3/4 US26D ARC SCC KD ASA	127286
3680 ADJ 2-3/8" - 2-3/4" US26D AUG NC ASA IC	194130
3680 ADJ 2-3/8" - 2-3/4" US26D AUG SCC KD ASA	127288
3680 ADJ 2-3/8" - 2-3/4" US26D WTN NC ASA IC	194134

3680 ADJ 2-3/8 - 2-3/4 US26D WTN SCC KD ASA 127290

3680 ADJ 2-3/8" - 2-3/4" US3 ARC NC ASA IC	194139
3680 ADJ 2-3/8" - 2-3/4" US3 ARC SCC KD ASA	127344
3680 ADJ 2-3/8" TO 2-3/4" US3 AUG NC ASA IC	194140
3680 ADJ 2-3/8" - 2-3/4" US3 AUG SCC KD ASA	127346
3680 ADJ 2-3/8" - 2-3/4" US3 WTN NC ASA IC	194141
3680 ADJ 2-3/8" - 2-3/4" US3 WTN SCC KD ASA	127348
3680 ADJ 2-3/8" - 2-3/4" US4 ARC NC ASA IC	194142
3680 ADJ 2-3/8" - 2-3/4" US4 ARC SCC KD ASA	127350
3680 ADJ 2-3/8" - 2-3/4" US4 AUG NC ASA IC	194143
3680 ADJ 2-3/8" - 2-3/4" US4 AUG SCC KD ASA	127352
3680 ADJ 2-3/8" - 2-3/4" US4 WTN NC ASA IC	194145
3680 ADJ 2-3/8" 1 2-3/4" US4 WTN SCC KD ASA	127354

3710

3710 2-3/4" US10 ARC NC TEE IC005277
3710 2-3/4" US10 ARC SCC KD TEE005365
3710 2-3/4" US10 AUG NC TEE IC005268
3710 2-3/4" US10 AUG SCC KD TEE005328
3710 2-3/4" US10 WTN NC TEE IC005287
3710 2-3/4" US10 WTN SCC KD TEE005663
3710 2-3/4" US10B ARC NC TEE IC005275
3710 2-3/4" US10B ARC SCC KD TEE005363
3710 2-3/4" US10B AUG NC TEE IC005267
3710 2-3/4" US10B AUG SCC KD TEE005316
3710 2-3/4" US10B WTN NC TEE IC005242
3710 2-3/4" US10B WTN SCC KD TEE005656
3710 2-3/4" US26 ARC NC TEE IC005274
3710 2-3/4" US26 ARC SCC KD TEE005355
3710 2-3/4" US26 AUG NC TEE IC005263
3710 2-3/4" US26 AUG SCC KD TEE005303
3710 2-3/4" US26 WTN NC TEE IC005284
3710 2-3/4" US26 WTN SCC KD TEE005651
3710 2-3/4" US26D ARC NC TEE IC005273
3710 2-3/4" US26D ARC SCC KD TEE005339
3710 2-3/4" US26D AUG NC TEE IC005262
3710 2-3/4" US26D AUG SCC KD TEE005302
3710 2-3/4" US26D WTN NC TEE IC005283
3710 2-3/4" US26D WTN SCC KD TEE005623
3710 2-3/4" US3 ARC NC TEE IC005282
3710 2-3/4" US3 ARC SCC KD TEE005369
3710 2-3/4" US3 AUG NC TEE IC005272
3710 2-3/4" US3 AUG SCC KD TEE005336
3710 2-3/4" US3 WTN NC TEE IC005290
3710 2-3/4" US3 WTN SCC KD TEE005684
3710 2-3/4" US4 ARC NC TEE IC005281
3710 2-3/4" US4 ARC SCC KD TEE005368
3710 2-3/4" US4 AUG NC TEE IC005271
3710 2-3/4" US4 AUG SCC KD TEE005335
3710 2-3/4" US4 WTN NC TEE IC005289
3710 2-3/4" US4 WTN SCC KD TEE005680

3753

3753 2-3/4" US10 WTN SCC KD TEE	115183
3753 2-3/4" US10B ARC SCC KD TEE	115191
3753 2-3/4" US10B AUG NC TEE IC99508
3753 2-3/4" US10B AUG SCC KD TEE	115199
3753 2-3/4" US10B WTN NC TEE IC	31698
3753 2-3/4" US10B WTN SCC KD TEE	15184
3753 2-3/4" US26 ARC SCC KD TEE	115193
3753 2-3/4" US26 AUG SCC KD TEE	115201
3753 2-3/4" US26 WTN SCC KD TEE	115186
3753 2-3/4" US26D ARC SCC KD TEE	115194
3753 2-3/4" US26D AUG SCC KD TEE	115204
3753 2-3/4" US26D WTN SCC KD TEE	115187
3753 2-3/4" US3 ARC SCC KD TEE	115188
3753 2-3/4" US3 AUG SCC KD TEE	115195
3753 2-3/4" US3 WTN SCC KD TEE	115181
3753 2-3/4" US4 WTN SCC KD TEE	115182

Items with the price in **bold and red** are Quick Ship Items and ship in 24 hours.

3796

3796 2-3/4" US10 WTN TEE.....	164177
3796 2-3/4" US10B ARC TEE.....	1184406
3796 2-3/4" US10B AUG TEE.....	165131
3796 2-3/4" US10B WTN TEE.....	155217
3796 2-3/4" US26 ARC TEE.....	193321
3796 2-3/4" US26 WTN TEE.....	132080
3796 2-3/4" US26D ARC TEE.....	166874
3796 2-3/4" US26D AUG TEE.....	161772
3796 2-3/4" US26D WTN TEE.....	158627
3796 2-3/4" US3 WTN TEE.....	92738
3796 2-3/4" US3 AUG TEE.....	191000
3796 2-3/4" US3 WTN TEE.....	197165
3796 2-3/4" US4 ARC TEE.....	94890
3796 2-3/4" US4 ARC TEE.....	80918

3810

3810 ESC US26D ARC.....	001029
3810 ESC US26D WLM.....	001118
3810 ESC US26D AUG.....	141107
3810 ESC US26D WTN.....	001070
3810 ESC US32D ARC.....	101244
3810 ESC US32D ARS.....	104200
3810 ESC US32D WLM.....	101245
3810 ESC US32D AUG.....	150016
3810 ESC US32D WLS.....	104202
3810 ESC US32D WTN.....	101242
3810 ESC US32D WTS.....	104198
3810 SECT US26D ARC.....	001035
3810 SECT US26D WLM.....	001132
3810 SECT US26D AUG.....	121368
3810 SECT US26D WTN.....	001078
3810 SECT US32D ARC.....	101243
3810 SECT US32D ARS.....	104199
3810 SECT US32D WLM.....	100652
3810 SECT US32D WLS.....	104201
3810 SECT US32D AUG.....	142537
3810 SECT US32D WTN.....	101241
3810 SECT US32D WTS.....	104197

3817

3817 ESC 26D ARC.....	101383
3817 ESC 26D WLM.....	101384
3817 ESC 26D AUG.....	186915
3817 ESC 26D WTN.....	101380
3817 ESC 32D ARC.....	101392
3817 ESC US32D ARS.....	143086
3817 ESC 32D WLM.....	101394
3817 ESC 32D AUG.....	176056
3817 ESC 32D WTN.....	101387
3817 SECT 26D ARC.....	101382
3817 SECT 26D WLM.....	101385
3817 SECT US26D AUG.....	122764
3817 SECT 26D WTN.....	101379
3817 SECT 32D ARC.....	101388
3817 SECT 32D ARS.....	118466

3817

3817 SECT 32D WLM.....	101393
3817 SECT 32D AUG.....	162223
3817 SECT 32D WTN.....	101386

3827

3827 ESC 26D ARC.....	101398
3827 ESC 26D WLM.....	101399
3827 ESC 26D AUG.....	124256
3827 ESC 26D WTN.....	101396
3827 ESC 32D ARC.....	101404
3827 ESC 32D WLM.....	101412
3827 ESC 32D AUG.....	173996
3827 ESC 32D WTN.....	101402
3827 SECT 26D ARC.....	101397
3827 SECT 26D WLM.....	101400
3827 SECT US26D AUG.....	122765
3827 SECT 26D WTN.....	101395
3827 SECT 32D ARC.....	101403
3827 SECT 32D ARS.....	118447
3827 SECT 32D WLM.....	101411
3827 SECT US32D WLS.....	110988
3827 SECT USU32D AUG.....	160253
3827 SECT 32D WTN.....	101401
3827 SECT US32D WTS.....	141202

3840

3840 ESC US26D ARC.....	000999
3840 ESC US26D WLM.....	000992
3840 ESC US26D AUG.....	118525
3840 ESC US26D WTN.....	001023
3840 ESC US32D ARC.....	101339
3840 ESC US32D ARS.....	104206
3840 ESC US32D WLM.....	101340
3840 ESC US32D WLS.....	104208
3840 ESC US32D WTN.....	101337
3840 ESC US32D WTS.....	104204
3840 SECT US26D ARC.....	001000
3840 SECT US26D WLM.....	000994
3840 SECT US26D AUG.....	122766
3840 SECT US26D WTN.....	001098
3840 SECT US32D ARC.....	101338
3840 SECT US32D ARS.....	104205
3840 SECT US32D WLM.....	100653
3840 SECT US32D WLS.....	104207
3840 SECT US32D AUG.....	131036
3840 SECT US32D WTN.....	101336
3840 SECT US32D WTS.....	104203

3844

3844 ESC US26D ARC.....	163963
3844 ESC US26D WLM.....	149362
3844 ESC US26D WTN.....	135035
3844 ESC US32D WLM.....	191634
3844 ESC US32D WTN.....	135357
3844 SECT US26D ARC.....	142322
3844 SECT US26D WLM.....	152401
3844 SECT US26D WTN.....	134987

Items with the price in **bold and red** are Quick Ship Items and ship in 24 hours.



3844

3844 SECT US26D WTS.	142453
3844 SECT US26D AUG.	170662
3844 SECT US32D ARC.	150965
3844 SECT US32D WTN.	135355
3844 SECT US32D WLM.	154720
3844 SECT US32D AUG.	93358

3850

3850 ESC US26D ARC.	100433
3850 ESC US26D ARC FULL6 SCC KD.	102922
3850 ESC US26D WLM.	100434
3850 ESC US26D WLM FULL6 SCC KD.	102924
3850 ESC US26D WTN.	100432
3850 ESC US26D WTN FULL6 SCC KD.	102920
3850 ESC US32D ARC.	101236
3850 ESC US32D ARC FULL6 SCC KD.	102969
3850 ESC US32D ARS.	103657
3850 ESC US32D ARS FULL6 SCC KD.	103658
3850 ESC US32D WLM.	101239
3850 ESC US32D WLM FULL6 SCC KD.	102971
3850 ESC US32D WLS.	103659
3850 ESC US32D WLS FULL6 SCC KD.	103660
3850 ESC US32D AUG FULL6 SCC KD.	146929
3850 ESC US32D WTN.	101232
3850 ESC US32D WTN FULL6 SCC KD.	102967
3850 ESC US32D WTS.	103746
3850 ESC US32D WTS FULL6 SCC KD.	103661
3850 SECT US26D ARC.	000965
3850 SECT US26D ARC FULL6 SCC KD.	102921
3850 SECT US26D WLM.	000959
3850 SECT US26D WLM FULL6 SCC KD.	102923
3850 SECT US26D AUG.	136008
3850 SECT US26D AUG FULL6 SCC KD.	122972

3850 SECT US26D WTN 000972

3850 SECT US26D WTN FULL6 SCC KD.	102925
3850 SECT US32D ARC.	101234
3850 SECT US32D ARC FULL6 SCC KD.	102968
3850 SECT US32D ARS.	103360
3850 SECT US32D ARS FULL6 SCC KD.	103361
3850 SECT US32D WLM.	101238
3850 SECT US32D WLM FULL6 SCC KD.	102970
3850 SECT US32D WLS.	103662
3850 SECT US32D WLS FULL6 SCC KD.	103663
3850 SECT US32D AUG.	190593
3850 SECT US32D AUG FULL6 SCC KD.	121583
3850 SECT US32D WTN.	101230
3850 SECT US32D WTN FULL6 SCC KD.	102966
3850 SECT US32D WTS.	103358
3850 SECT US32D WTS FULL6 SCC KD.	103359

3853

3853 ESC US26D ARC REV 1.	115862
3853 ESC US26D ARC FULL6 SCC KD REV 1.	115630
3853 ESC US26D WLM REV 1.	115868
3853 ESC US26D WLM FULL6 SCC KD REV 1.	115631

3853

3853 ESC US26D AUG REV 1.	165082
3853 ESC US26D AUG FULL6 SCC KD REV 1.	125154
3853 ESC US26D WTN REV 1.	115873
3853 ESC US26D WTN FULL6 SCC KD.	115632
3853 ESC US32D ARC REV 1.	115878
3853 ESC US32D ARC FULL6 SCC KD REV 1.	115880
3853 ESC US32D ARS REV 1.	115881
3853 ESC US32D ARS FULL6 SCC KD REV 1.	115882
3853 ESC US32D WLM REV 1.	115883
3853 ESC US32D WLM FULL6 SCC KD REV 1.	115885
3853 ESC US32D WLS REV 1.	115890
3853 ESC US32D WLS FULL6 SCC KD REV 1.	115891
3853 ESC US32D AUG REV 1.	116214
3853 ESC US32D AUG FULL6 SCC KD REV 1.	150013
3853 ESC US32D WTN REV 1.	115892
3853 ESC US32D WTN FULL6 SCC KD REV 1.	115894
3853 ESC US32D WTS REV 1.	115895
3853 ESC US32D WTS FULL6 SCC KD REV 1.	115896
3853 SECT US26D ARC REV 1.	115900
3853 SECT US26D ARC FULL6 SCC KD.	115902
3853 SECT US26D ARS FULL6 SCC KD (REV.1).	139693
3853 SECT US26D WLM REV 1.	115905
3853 SECT US26D WLM FULL6 SCC KD REV 1.	115633
3853 SECT US26D AUG REV 1.	131092
3853 SECT US26D AUG FULL6 SCC KD REV.1.	120892
3853 SECT US26D WTN REV 1.	115909
3853 SECT US26D WTN FULL6 SCC KD.	115634
3853 SECT US32D ARC REV 1.	115914
3853 SECT US32D ARC FULL6 SCC KD REV 1.	115916
3853 SECT US32D ARS REV 1.	115917
3853 SECT US32D ARS FULL6 SCC KD (REV.1).	115918
3853 SECT US32D WLM REV 1.	115919
3853 SECT US32D WLM FULL6 SCC KD REV 1.	115921
3853 SECT US32D WLS REV 1.	115922
3853 SECT US32D WLS FULL6 SCC KD REV 1.	115923
3853 SECT US32D AUG REV 1.	186817
3853 SECT US32D AUG FULL6 SCC KD REV.1.	121377
3853 SECT US32D WTN REV 1.	115924
3853 SECT US32D WTN FULL6 SCC KD REV 1.	115926
3853 SECT US32D WTS REV 1.	115927
3853 SECT US32D WTS FULL6 SCC KD REV 1.	115928

Items with the price in **bold and red** are Quick Ship Items and ship in 24 hours.

3856

3856 ESC US26D ARC.....	143380
3856 ESC US26D ARC FULL6 SCC KD.....	143383
3856 ESC US26D WLM.....	151761
3856 ESC US26D WLM FULL6 SCC KD.....	089194
3856 ESC US26D WTN.....	135551
3856 ESC US26D WTN FULL6 SCC KD.....	135552
3856 ESC US26D AUG.....	183700
3856 ESC US26D AUG FULL6 SCC KD.....	156475
3856 ESC US32D WLM FULL6 SCC KD.....	155443
3856 ESC US32D WTN.....	135583
3856 ESC US32D WTN FULL6 SCC KD.....	135588
3856 ESC US32D AUG FULL6 SCC KD.....	155029
3856 SECT US26D ARC.....	143841
3856 SECT US26D ARC FULL6 SCC KD.....	143840
3856 SECT US26D WLM.....	154564
3856 SECT US26D WLM FULL6 SCC KD.....	154572
3856 SECT US26D WTN.....	135529
3856 SECT US26D WTN FULL6 SCC KD.....	109876
3856 SECT US26D AUG.....	148175
3856 SECT US26D AUG FULL6 SCC KD.....	148208
3856 SECT US32D ARC.....	040927
3856 SECT US32D ARC FULL6 SCC KD.....	097797
3856 SECT US32D WLM.....	177023
3856 SECT US32D WLM FULL6 SCC KD.....	171768
3856 SECT US32D WTN.....	135557
3856 SECT US32D WTN FULL6 SCC KD.....	135582
3856 SECT US32D AUG.....	149221
3856 SECT US32D AUG FULL6 SCC KD.....	149232

3857

3857 ESC US26D ARC REV 1.....	123411
3857 ESC US26D ARC FULL6 SCC KD REV 1.....	123830
3857 ESC US26D WLM REV 1.....	123840
3857 ESC US26D WLM FULL6 SCC KD REV 1.....	123868
3857 ESC US26D AUG.....	118526
3857 ESC US26D WTN REV 1.....	123871
3857 ESC US26D WTN FULL6 SCC KD REV 1.....	123872
3857 ESC US32D ARC REV 1.....	123875
3857 ESC US32D ARC FULL6 SCC KD REV 1.....	123876
3857 ESC US32D ARS REV 1.....	123879
3857 ESC US32D ARS FULL6 SCC KD REV 1.....	123880
3857 ESC US32D WLM REV 1.....	123881
3857 ESC US32D WLM FULL6 SCC KD REV 1.....	123882
3857 ESC US32D WLS REV 1.....	123932
3857 ESC US32D WLS FULL6 SCC KD REV 1.....	123933
3857 ESC US32D WTN REV 1.....	123935
3857 ESC US32D WTN FULL6 SCC KD REV 1.....	123936
3857 ESC US32D WTS REV 1.....	123937
3857 ESC US32D WTS FULL6 SCC KD REV 1.....	123938
3857 SECT US26D ARC REV 1.....	123939
3857 SECT US26D ARC FULL6 SCC KD REV 1.....	123940
3857 SECT US26D WLM REV 1.....	123980
3857 SECT US26D WLM FULL6 SCC KD REV 1.....	123981

3857

3857 SECT US26D AUG REV 1.....	182060
3857 SECT US26D AUG FULL6 SCC KD REV 1.....	139898
3857 SECT US26D WTN REV 1.....	123984
3857 SECT US26D WTN FULL6 SCC KD REV 1.....	123985
3857 SECT US32D ARC REV 1.....	123989
3857 SECT US32D ARC FULL6 SCC KD REV 1.....	123991
3857 SECT US32D ARS REV 1.....	123992
3857 SECT US32D ARS FULL6 SCC KD REV 1.....	123993
3857 SECT US32D WLM REV 1.....	123994
3857 SECT US32D WLM FULL6 SCC KD REV 1.....	123995
3857 SECT US32D WLS REV 1.....	124068
3857 SECT US32D WLS FULL6 SCC KD REV 1.....	124069
3857 SECT US32D AUG FULL6 SCC KD REV 1.....	131477
3857 SECT US32D WTN REV 1.....	124070
3857 SECT US32D WTN FULL6 SCC KD REV 1.....	124071
3857 SECT US32D WTS REV 1.....	124072
3857 SECT US32D WTS FULL6 SCC KD REV 1.....	124073

3870

3870 ESC US26D ARC.....	100370
3870 ESC US26D ARC FULL6 SCC KD.....	102930
3870 ESC US26D WLM.....	100374
3870 ESC US26D WLM FULL6 SCC KD.....	102932
3870 ESC US26D AUG.....	169053
3870 ESC US26D AUG FULL6 SCC KD.....	160268
3870 ESC US26D WTN.....	100365
3870 ESC US26D WTN FULL6 SCC KD.....	102928
3870 ESC US32D ARC.....	101187
3870 ESC US32D ARC FULL6 SCC KD.....	102937
3870 ESC US32D ARS.....	103703
3870 ESC US32D ARS FULL6 SCC KD.....	103704
3870 ESC US32D WLM.....	101191
3870 ESC US32D WLM FULL6 SCC KD.....	102939
3870 ESC US32D AUG FULL6 SCC KD.....	155032
3870 ESC US32D WLS.....	103705
3870 ESC US32D WLS FULL6 SCC KD.....	103706
3870 ESC US32D WTN.....	101182
3870 ESC US32D WTN FULL6 SCC KD.....	102934
3870 ESC US32D WTS.....	103707
3870 ESC US32D WTS FULL6 SCC KD.....	103708

3870 SECT US26D ARC..... 100368

3870 SECT US26D ARC FULL6 SCC KD.....	102929
3870 SECT US26D WLM.....	100372
3870 SECT US26D WLM FULL6 SCC KD.....	102931
3870 SECT US26D AUG.....	143782
3870 SECT US26D AUG FULL6 SCC KD.....	121680

3870 SECT US26D WTN..... 100362

3870 SECT US26D WTN FULL6 SCC KD.....	102927
3870 SECT US32D ARC.....	101185
3870 SECT US32D ARC FULL6 SCC KD.....	102936
3870 SECT US32D ARS.....	103348
3870 SECT US32D ARS FULL6 SCC KD.....	103357
3870 SECT US32D WLM.....	101189
3870 SECT US32D WLM FULL6 SCC KD.....	102938
3870 SECT US32D WLS.....	103709

Items with the price in **bold and red** are Quick Ship Items and ship in 24 hours.



3870

3870 SECT US32D WLS FULL6 SCC KD	103710
3870 SECT US32D AUG	172482
3870 SECT US32D AUG FULL6 SCC KD	165954
3870 SECT US32D WTN	101181
3870 SECT US32D WTN FULL6 SCC KD	102933
3870 SECT US32D WTS	103346
3870 SECT US32D WTS FULL6 SCC KD	103347

3880

3880 ESC US26D ARC	100447
3880 ESC US26D ARC FULL6 SCC KD	102981
3880 ESC US26D WLM	100444
3880 ESC US26D WLM FULL6 SCC KD	102983
3880 ESC US26D AUG	118527
3880 ESC US26D AUG FULL6 SCC KD	136173
3880 ESC US26D WTN	100446
3880 ESC US26D WTN FULL6 SCC KD	102979
3880 ESC US32D ARC	101347
3880 ESC US32D ARC FULL6 SCC KD	102987
3880 ESC US32D ARS	103714
3880 ESC US32D ARS FULL6 SCC KD	103715
3880 ESC US32D WLM	101350
3880 ESC US32D WLM FULL6 SCC KD	102989
3880 ESC US32D AUG FULL6 SCC KD	155032
3880 ESC US32D WLS	103716
3880 ESC US32D WLS FULL6 SCC KD	103717
3880 ESC US32D WTN	101343
3880 ESC US32D WTN FULL6 SCC KD	102985
3880 ESC US32D WTS	103718
3880 ESC US32D WTS FULL6 SCC KD	103719

3880 SECT US26D ARC 100438

3880 SECT US26D ARC FULL6 SCC KD	102980
3880 SECT US26D WLM	100441
3880 SECT US26D WLM FULL6 SCC KD	102982
3880 SECT US26D AUG	122767
3880 SECT US26D AUG FULL6 SCC KD	121692

3880 SECT US26D WTN 100435

3880 SECT US26D WTN FULL6 SCC KD	102975
3880 SECT US32D ARC	101345
3880 SECT US32D ARC FULL6 SCC KD	102986
3880 SECT US32D ARS	103355
3880 SECT US32D ARS FULL6 SCC KD	103356
3880 SECT US32D WLM	101349
3880 SECT US32D WLM FULL6 SCC KD	102988
3880 SECT US32D WLS	103720
3880 SECT US32D WLS FULL6 SCC KD	103721
3880 SECT US32D AUG	154108
3880 SECT US32D AUG FULL6 SCC KD	124258
3880 SECT US32D WTN	101341
3880 SECT US32D WTN FULL6 SCC KD	102984
3880 SECT US32D WTS	103353
3880 SECT US32D WTS FULL6 SCC KD	103354

3881

3881 ESC US26D ARC REV 1	115636
3881 ESC US26D ARC FULL6 SCC KD REV 1	115637

3881

3881 ESC US26D WLM REV 1	115641
3881 ESC US26D WLM FULL6 SCC KD REV 1	115642
3881 ESC US26D AUG FULL6	183022
3881 ESC US26D WTN REV 1	115646
3881 ESC US26D WTN FULL6 SCC KD REV 1	115647
3881 ESC US32D ARC REV 1	115650
3881 ESC US32D ARC FULL6 SCC KD REV 1	115651
3881 ESC US32D ARS REV 1	115652
3881 ESC US32D ARS FULL6 SCC KD REV 1	115653
3881 ESC US32D WLM REV 1	115654
3881 ESC US32D WLM FULL6 SCC KD REV 1	115655
3881 ESC US32D WLS REV 1	115681
3881 ESC US32D WLS FULL6 SCC KD REV 1	115682
3881 ESC US32D AUG FULL6 SCC KD REV 1	155039
3881 ESC US32D WTN REV 1	115683
3881 ESC US32D WTN FULL6 SCC KD REV 1	115684
3881 ESC US32D WTS REV 1	115685
3881 ESC US32D WTS FULL6 SCC KD REV 1	115686
3881 SECT US26D ARC REV 1	115687
3881 SECT US26D ARC FULL6 SCC KD REV 1	115689
3881 SECT US26D WLM REV 1	115692
3881 SECT US26D WLM FULL6 SCC KD REV 1	115693
3881 SECT US26D AUG REV 1	123601
3881 SECT US26D AUG FULL6 SCC KD REV 1	130006
3881 SECT US26D WTN REV 1	115696
3881 SECT US26D WTN FULL6 SCC KD REV 1	115697
3881 SECT US32D ARC REV 1	115765
3881 SECT US32D ARC FULL6 SCC KD REV 1	115766
3881 SECT US32D ARS REV 1	115767
3881 SECT US32D ARS FULL6 SCC KD REV 1	115768
3881 SECT US32D WLM REV 1	115769
3881 SECT US32D WLM FULL6 SCC KD REV 1	115770
3881 SECT US32D WLS REV 1	115771
3881 SECT US32D WLS FULL6 SCC KD REV 1	115772
3881 SECT US32D AUG FULL6 SCC KD REV 1	146044
3881 SECT US32D WTN REV 1	115773
3881 SECT US32D WTN FULL6 SCC KD REV 1	115774
3881 SECT US32D WTS REV 1	115775
3881 SECT US32D WTS FULL6 SCC KD REV 1	115776

3896

3896 ESC US26D ARC	158649
3896 ESC US26D WLM	149413
3896 ESC US26D AUG	183564
3896 ESC US26D WTN	135359
3896 ESC US32D ARC	145397
3896 ESC US32D ARS	160060
3896 ESC US32D WLM	166864
3896 ESC US32D WLS	174822
3896 ESC US32D AUG	150088
3896 ESC US32D WTN	135527
3896 ESC US32D WTS	160745
3896 SECT US26D ARC	134470

Items with the price in **bold and red** are Quick Ship Items and ship in 24 hours.

3896

3896 SECT US26D WLM.....	154738
3896 SECT US26D AUG.....	139558
3896 SECT US32D ARC.....	137506
3896 SECT US32D ARS.....	151852
3896 SECT US32D WLM.....	137507
3896 SECT US32D WLS.....	145358
3896 SECT US32D AUG.....	152523
3896 SECT US32D WTN.....	135526
3896 SECT US32D WTS.....	150604

3901

3901 US10 7PCYL H1 KD 7PKEY.....	165023
3901 US10B 7PCYL H1 KD 7PKEY.....	165024
3901 US26 7PCYL H1 KD 7PKEY.....	165021
3901 US26D 7PCYL H1 KD 7PKEY.....	165019
3901 US3 7PCYL H1 KD 7PKEY.....	165022
3901 US4 7PCYL H1 KD 7PKEY.....	165020
3901 US10 6PCYL SCC KD.....	097960
3901 US10B 6PCYL SCC KD.....	097959
3901 US26 6PCYL SCC KD.....	097958
3901 US26D 6PCYL SCC KD.....	097955
3901 US3 6PCYL SCC KD.....	097962
3901 US4 6PCYL SCC KD.....	097961
3901 US10 NC IC6.....	018874
3901 US10B NC IC6.....	821186
3901 US26 NC IC6.....	186110
3901 US26D NC IC6.....	017485
3901 US3 NC IC6.....	082166
3901 US4 NC IC6.....	036952
3901 US10 NC IC7.....	109138
3901 US10B NC IC7.....	074697
3901 US26 NC IC7.....	116314
3901 US26D NC IC7.....	057961
3901 US3 NC IC7.....	067659
3901 US4 NC IC7.....	017000
3901 US10 LF LFIC.....	181627
3901 US10B LF LFIC.....	181628
3901 US26 LF LFIC.....	181630
3901 US26D LF LFIC.....	181633
3901 US3 LF LFIC.....	181625
3901 US4 LF LFIC.....	181626

3902

3902 1-1/8" US10 7PCYL H1 KD STD CAM.....	165035
3902 1-1/8" US10B 7PCYL H1 KD STD CAM.....	165030
3902 1-1/8" US26 7PCYL H1 KD STD CAM.....	165033
3902 1-1/8" US26D 7PCYL H1 KD STD CAM.....	165031
3902 1-1/8" US3 7PCYL H1 KD STD CAM.....	165028
3902 1-1/8" US4 7PCYL H1 KD STD CAM.....	165032
3902 1-1/4" US10 7PCYL H1 KD STD CAM.....	165063
3902 1-1/4" US10B 7PCYL H1 KD STD CAM.....	165064
3902 1-1/4" US26 7PCYL H1 KD STD CAM.....	165061
3902 1-1/4" US26D 7PCYL H1 STD CAM.....	165059
3902 1-1/4" US3 7PCYL H1 KD STD CAM.....	165062
3902 1-1/4" US4 7PCYL H1 KD STD CAM.....	165060
3902 1-1/8" US10 SCC KD STD CAM.....	097949
3902 1-1/8" US10B SCC KD STD CAM.....	097952

Items with the price in **bold and red** are Quick Ship Items and ship in 24 hours.

3902 1-1/8" US26 SCC KD STD CAM.....	097941
3902 1-1/8" US26D SCC KD STD CAM.....	097939
3902 1-1/8" US3 SCC KD STD CAM.....	097944
3902 1-1/8" US4 SCC KD STD CAM.....	097945
3902 1-1/4" US10 SCC KD STD CAM.....	097948
3902 1-1/4" US10B SCC KD STD CAM.....	097954
3902 1-1/4" US26 SCC KD STD CAM.....	097942
3902 1-1/4" US26D SCC KD STD CAM.....	097940
3902 1-1/4" US3 SCC KD STD CAM.....	097943
3902 1-1/4" US4 SCC KD STD CAM.....	097947
3902 1-1/4" US10 NC IC6 STD CAM.....	055419
3902 1-1/4" US10B NC IC6 STD CAM.....	014394
3902 1-1/4" US26 NC IC6 STD CAM.....	101470
3902 1-1/4" US26D NC IC6 STD CAM.....	081777
3902 1-1/4" US3 NC IC6 STD CAM.....	100683
3902 1-1/4" US4 NC IC6 STD CAM.....	124503
3902 1-3/8" US10 NC IC7 STD CAM.....	054177
3902 1-3/8" US10B NC IC7 STD CAM.....	102506
3902 1-3/8" US26 NC IC7 STD CAM.....	116344
3902 1-3/8" US26D NC IC7 STD CAM.....	58154
3902 1-3/8" US3 NC IC7 STD CAM.....	067670
3902 1-3/8" US4 NC IC7 STD CAM.....	113147
3902 1-1/2" US10 LF LFIC STD CAM.....	181609
3902 1-1/2" US10B LF LFIC STD CAM.....	181610
3902 1-1/2" US26 LF LFIC STD CAM.....	181611
3902 1-1/2" US26D LF LFIC STD CAM.....	181612
3902 1-1/2" US3 LF LFIC STD CAM.....	181606
3902 1-1/2" US4 LF LFIC STD CAM.....	181608

3903

3903 US10 DUMMY RIM CYL.....	123098
3903 US10B DUMMY RIM CYL.....	123099
3903 US26 DUMMY RIM CYL.....	123100
3903 US26D DUMMY RIM CYL.....	123101
3903 US3 DUMMY RIM CYL.....	123096
3903 US4 DUMMY RIM CYL.....	123097

3904

3904 1-1/8" US10 DUMMY MORTISE CYL.....	104063
3904 1-1/8" US10B DUMMY MORTISE CYL.....	104074
3904 1-1/8" US26 DUMMY MORTISE CYL.....	104065
3904 1-1/8" US26D DUMMY MORTISE CYL.....	104075
3904 1-1/8" US3 DUMMY MORTISE CYL.....	104061
3904 1-1/8" US4 DUMMY MORTISE CYL.....	104062
3904 1-1/4" US10B DUMMY MORTISE CYL.....	104070
3904 1-1/4" US26 DUMMY MORTISE CYL.....	104071
3904 1-1/4" US26D DUMMY MORTISE CYL.....	104072
3904 1-1/4" US3 DUMMY MORTISE CYL.....	104067

3905

3905 1-1/8" US10B ADA TURN MORTISE CYL AR CAM.....	141863
3905 1-1/8" US26D ADA TURN MORTISE CYL AR CAM.....	134838
3905 1-1/8" US10B ADA TURN MORTISE CYL SCH CAM.....	104056
3905 1-1/8" US26D ADA TURN MORTISE CYL SCH CAM.....	104057
3905 1-1/4" US10B ADA TURN MORTISE CYL SCH CAM.....	104059
3905 1-1/4" US26D ADA TURN MORTISE CYL SCH CAM.....	104060

3906

3906 US26D H1 KD 7PKEY.....	164999
3906 US4 H1 KD 7PKEY.....	165000



3907

3907 H1 Key Blank165065

3909

3909 US26D H1 UNC IC7.....165005

3909 US4 H1 UNC IC7.....165006

3955

3955 SCC KEY BLANK (5PIN).....96173

3956

3956 SCC KEY BLANK (6PIN).....96174

3969

3969 US26D H1 KD IC7.....170853

3969 US4 H1 KD IC7.....170860

Items with the price in **bold and red** are Quick Ship Items and ship in 24 hours.



H **HAGER**[®]
COMPANIES

TABLE OF CONTENTS

A

Arms, 5100 Series

Main Arm Assembly.....6
 Extra Heavy Duty Parallel7
 Extra Heavy Duty Hold Open7
 Extra Heavy Duty Stop8
 Extra Heavy Duty Hold Open Stop.....9
 Extra Heavy Duty Hold Open Cushion Stop.....9
 Extra Heavy Duty Cushion Stop9
 Standard Hold Open7
 Track Arms.....9-10

Arms, 5200 Series

Main Arm Assembly..... 12
 Extra Heavy Duty Hold Open Cushion Stop..... 15
 Extra Heavy Duty Cushion Stop 15
 Extra Heavy Duty 13
 Extra Heavy Duty Hold Open 13
 Extra Heavy Duty Hold Open Stop..... 13
 Extra Heavy Duty Stop 13
 Standard Hold Open 13
 Track Arms.....15-16

Arms, 5300 Series

Main Arm Assembly..... 18
 Extra Heavy Duty 19
 Extra Heavy Duty Hold Open 19
 Extra Heavy Duty Hold Open Stop..... 19
 Extra Heavy Duty Stop 19
 Extra Heavy Duty Hold Open Cushion Stop..... 20
 Extra Heavy Duty Cushion Stop 20
 Standard Hold Open 19
 Track Arms.....20-21

Arms, 5400 Series

Main Arm Assembly..... 22

B

Blade Stop Spacer

5100 Series7
 5200 Series 14
 5300 Series..... 20
 5400 Series 23

Body Only

5100 Series, Cast Iron.....6
 5200 Series, Aluminum 12
 5300 Series, Aluminum 18
 5400 Series, Aluminum 22

Brackets

Extra Clearance, 5100 Series.....8

Extra Clearance, 5200 Series..... 14
 Extra Clearance, 5300 Series.....20
 Extra Heavy Duty Parallel Arm, 5100 Series..... 7
 Hold Open Parallel Arm, 5200 Series 13
 Hold Open Parallel Arm, 5300 Series 19
 Parallel Arm, 5100 Series..... 8
 Parallel Arm, 5200 Series..... 12
 Parallel Arm, 5300 Series..... 18
 Parallel Arm, 5400 Series.....23

C

Closers

5100 Series, Grade 1 5
 5200 Series, Grade 1 11
 5300 Series, Grade 1 17
 5400 Series, Grade 222

Covers

5100 Series, Full Plastic..... 6
 5100 Series, Metal 9
 5200 Series, Full Plastic..... 12
 5200 Series, Slim Line Plastic 14
 5200 Series, Metal 14
 5300 Series, Full Plastic..... 18

D

Drop Plates

5100 Series, Regular Arm 7
 5100 Series, Low Clearance..... 7
 5100 Series, Parallel Arm..... 7
 5100 Series, Top Jamb..... 8
 5200 Series, Top Jamb, Narrow Top Rail..... 14
 5200 Series, Narrow Top Rail 14
 5200 Series, Top Jamb, Parallel Arm..... 14
 5200 Series, Parallel Arm 14
 5300 Series, Narrow Rail, Parallel Arm..... 20
 5300 Series, Low Clearance..... 20
 5300 Series, OH Holder, Narrow..... 20

E

Electromagnetic Door Holders & Accessories

Accessories 25-26
 Floor Mount (Double Door) 24
 Floor Mount (Single Door)..... 24
 Flush Mount 24
 Recessed Mount 24
 Surface Mount..... 24

H

High Security Package, 5100 Series..... 6
 How To Order 3-4



Door Controls

	L			S	
Lead Times		2	Screw Packs		
Long Rod and Shoe, 5100 Series.....		7	5100 Series		7-8
Long Rod and Shoe, 5200 Series.....		13	5200 Series		12-13
Long Rod and Shoe, 5300 Series.....		19	5300 Series		18-19
	O		5400 Series		23
Overhead Door Holders and Stops		27-30	Spring Cushion Kit		8,15, 20
	P			T	
Pinion Cap			Track Arms		
5200 Series		14	5100 Series		6, 9-10
5300 Series		18	5200 Series		12, 15-16
5400 Series		23	5300 Series		18, 20-21
	Q				
Quick Ship.....		2			

INTRODUCTION

Hager door controls offer architects, contractors, and building owners a superior product with proven reliability. In fact, our 5100, 5200, and 5300 Series Grade 1 models are the only closers in the industry that are both BHMA certified and backed by a lifetime warranty. That makes them a no-risk choice for virtually any building type.

With Hager, you get door controls that are packaged with everything needed for quick installation, regardless of the application. Hager door closers are tri-packed for mounting three ways: parallel arm, regular arm, and top jamb. They are non-handed, packaged with a parallel arm bracket and thru-bolts at no extra charge, and adjustable for various door sizes.

Quick Ship

Products denoted with **red and bold** pricing are available to order through the Quick Ship program and ship within 24 hours. When ordering these products please visit www.hagerco.com and log in to MyHager to access the 'Quick Ship' portal. Due to the promptness of the fulfillment process, Quick Ship orders are non-cancellable.

Lead Times

Stock items will typically ship in five working days or less from the order entry date. Made-to-order items will typically ship in 15 working days depending on seasonal volume and order complexity. Special orders including industrials, special machining, and large quantities may need to be scheduled. The anticipated ship date will be included with each order acknowledgement. Please contact Customer Service if product availability is in question.

New Finish

Painted flat black finish (BHMA 693) is now available. Use BLK to designate finish. Extended lead time and MOQ may apply.

Cancellation Notification

Cancellation for made-to-order items must be communicated within 48 hours of order placement.

HOW TO ORDER

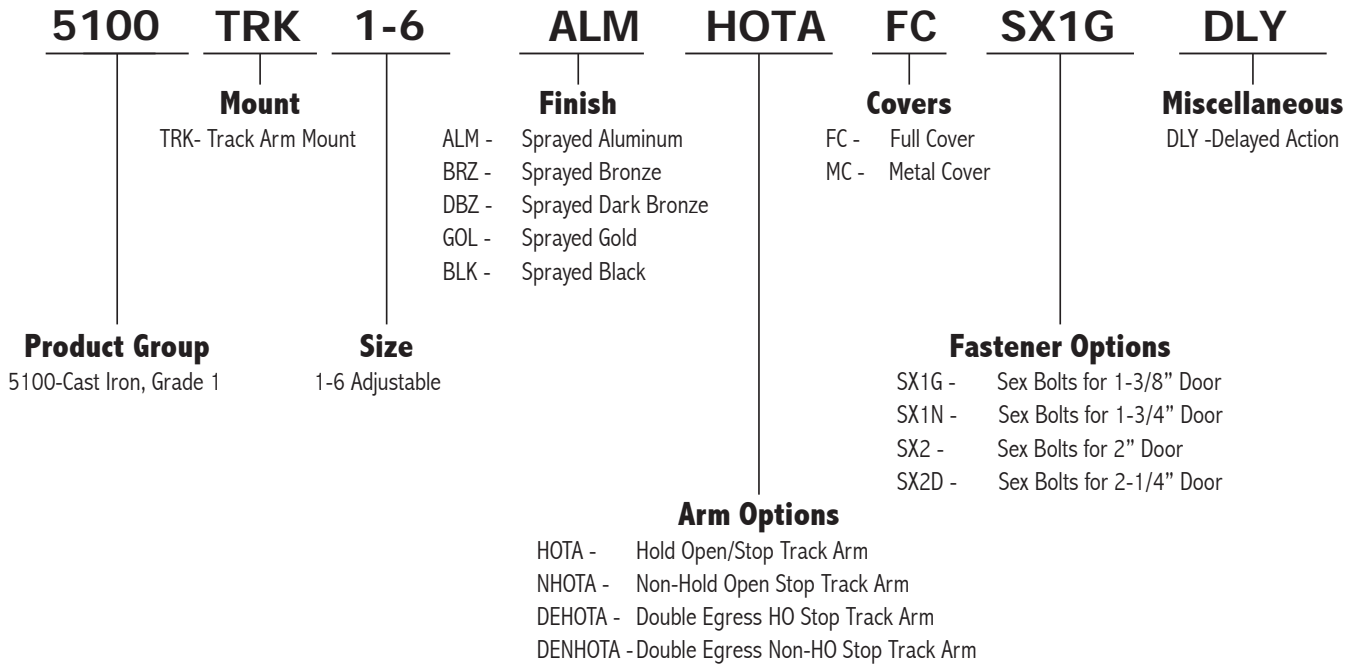

HOW TO ORDER

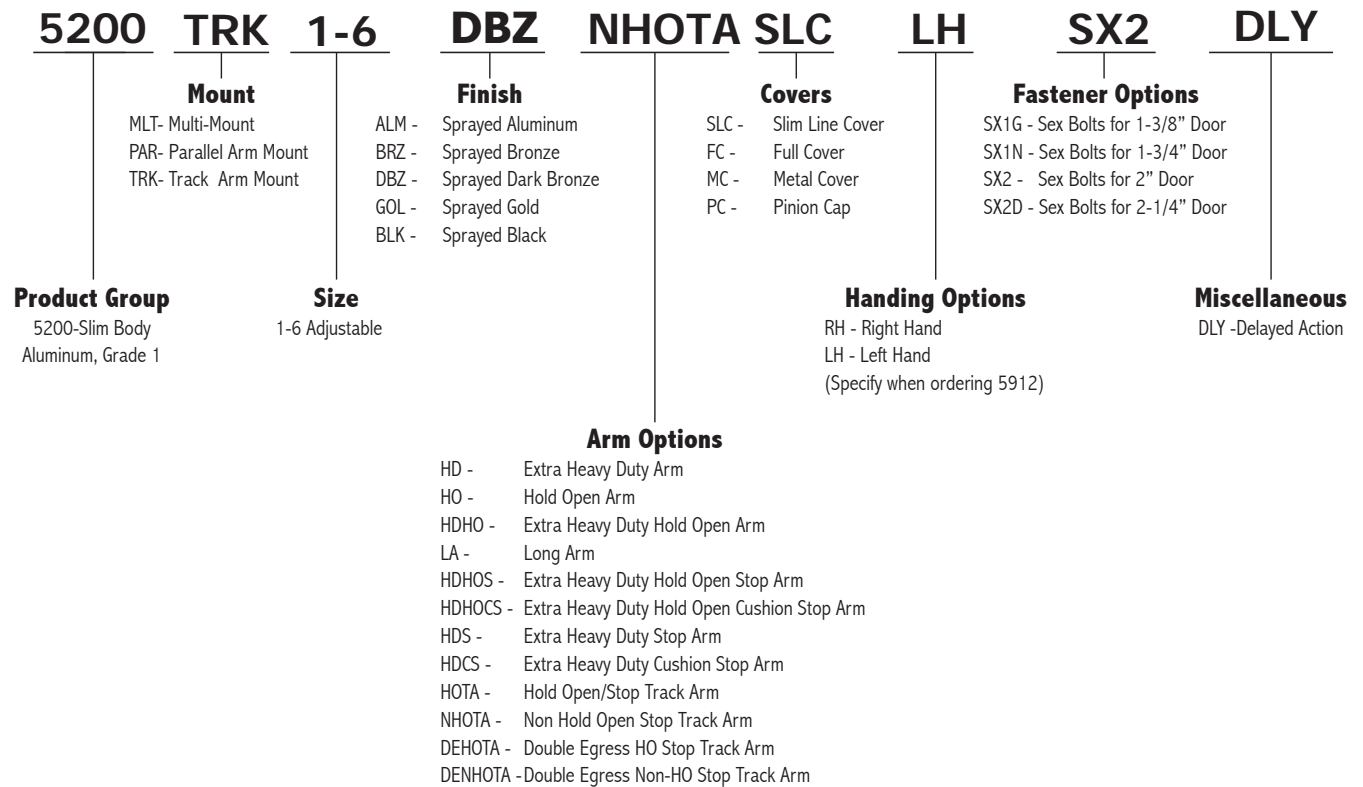

Door Controls

HOW TO ORDER

5300	TRK	1-6	DBZ	HOTA	FC	RH	SX1G	DLY
Product Group 5300 - Aluminum, Grade 1	Mount MLT- Multi-Mount PAR- Parallel Arm Mount TRK- Track Arm Mount	Size 1-6 Adjustable	Finish ALM - Sprayed Aluminum BRZ - Sprayed Bronze DBZ - Sprayed Dark Bronze GOL - Sprayed Gold BLK - Sprayed Black	Arm Options HD - Extra Heavy Duty Arm HO - Hold Open Arm HDHO - Extra Heavy Duty Hold Open Arm LA - Long Arm HDHOS - Extra Heavy Duty Hold Open Stop Arm HDHOCS - Extra Heavy Duty Hold Open Cushion Stop Arm HDS - Extra Heavy Duty Stop Arm HDCS - Extra Heavy Duty Cushion Stop Arm HOTA - Hold Open/Stop Track Arm NHOTA - Non Hold Open Stop Track Arm	Covers FC - Full Cover PC - Pinion Cap	Handing Options RH - Right Hand LH - Left Hand (Specify when ordering 5912)	Fastener Options SX1G - Sex Bolts for 1-3/8" Door SX1N - Sex Bolts for 1-3/4" Door SX2 - Sex Bolts for 2" Door SX2D - Sex Bolts for 2-1/4" Door	Miscellaneous DLY -Delayed Action



Door Controls - 5100 Series



Description	Finish	2021 List	Stock No.	Case Qty.	Box Qty.
5100 Series	ALM	325.10	126470	4	1
Grade 1	BRZ	325.10	126473		
Adjustable sizes 1-6	DBZ	325.10	126472		
	GOL	325.10	126474		
	BLK	325.10	199292		
	32D	532.80	062640		

ADA (Barrier Free) Door Closers:

Any certified BHMA/ANSI A156.4 door closer, regardless of manufacturer, that is installed and adjusted based on ADA or other reduced opening force requirements may not provide sufficient power to reliably close and latch a door.

If arms are ordered separately, there will be a significant difference in price than if purchased with a closer as a complete assembly. Adders are listed below. Add the list price of the option to the list price of the closer and take standard discounts.

Delayed Action Valve

17.70

Lead Lined Cover

111.40

Check with factory for pricing and availability of plated products.

POA

Closers with non-standard arms

5100 Series 1-6 Closer, 5106 extra heavy duty arm, plastic cover	ALM	373.40	130952
	BRZ	373.40	130970
	DBZ	373.40	130973
	GOL	373.40	130976
5100 Series 1-6 Closer, 5107 standard hold open arm, plastic cover	ALM	364.25	126475
	BRZ	364.25	130899
	DBZ	364.25	130947
	GOL	364.25	130951
5100 Series 1-6 Closer, 5108 extra heavy duty hold open arm, plastic cover (left hand)	ALM	360.70	130956
	BRZ	360.70	149871
	DBZ	360.70	151034
	GOL	360.70	156482
5100 Series 1-6 Closer, 5108 extra heavy duty hold open arm , plastic cover (right hand)	ALM	360.70	130957
	BRZ	360.70	149872
	DBZ	360.70	151033
	GOL	360.70	156483
5100 Series 1-6 Closer, 5125 extra heavy duty stop arm, plastic cover	ALM	373.40	130961
	BRZ	373.40	130972
	DBZ	373.40	130975
	GOL	373.40	130978
5100 Series 1-6 Closer, 5954 extra heavy duty hold open cushion stop arm, plastic cover	ALM	513.70	130959
	BRZ	513.70	149499
	DBZ	513.70	148985
	GOL	513.70	154060

1. Items with the price in **bold and red** are Quick Ship items and ship in 24 hours.
Please use stock number when ordering. 2. U/M is each unless otherwise noted.



Door Controls - 5100 Series

Description	Finish	2021 List	Stock	Case Qty.	Box Qty.
5100 Series 1-6 Closer, 5955 extra heavy cushion stop arm, plastic cover	ALM	466.80	130962		
	BRZ	466.80	151220		
	DBZ	466.80	150847		
	GOL	466.80	155760		
5100 Series 1-6 Closer, 5961 extra heavy hold open stop arm, plastic cover	ALM	421.40	130958		
	BRZ	421.40	130971		
	DBZ	421.40	130974		
	GOL	421.40	130977		
5100M16GALMOMOX 5100 Series High Security Package Package Contains: Closer, main arm assembly, parallel arm bracket, standard screw pack, SNB screw pack, torx screw pack and painted metal cover.	ALM	378.10	152114	4	1
5100 Closer w/ Non Hold Open Stop Track Arm	ALM	370.15	166331	10	1
	BRZ	370.15	166352		
	DBZ	370.15	166332		
	GOL	370.15	166353		
5100 Closer w/ Hold Open Stop Track Arm	ALM	383.80	166337	10	1
	BRZ	383.80	166219		
	DBZ	383.80	166338		
	GOL	383.80	167220		
5100 Closer w/ Double Egress Non Hold Open Stop Track Arm	ALM	399.70	166344	10	1
	BRZ	399.70	167235		
	DBZ	399.70	166345		
	GOL	399.70	167236		
5100 Closer w/ Double Egress Hold Open Stop Track Arm	ALM	413.35	166348	10	1
	BRZ	413.35	167239		
	DBZ	413.35	166349		
	GOL	413.35	167240		
5101 5100 Series Closer Body Only Adjustable sizes 1-6	ALM	245.70	148803	4	1
	BRZ	245.70	148805		
	DBZ	245.70	148804		
	GOL	245.70	148806		
	BLK	245.70	199347		
	5102 Full Plastic Cover 5100 Series	ALM	17.15	89003	25
BRZ		17.15	88988		
DBZ		17.15	88928		
GOL		17.15	88730		
BLK		17.15	199349		
5103 Main Arm Assembly 5100 Series	ALM	34.00	72038	8	1
	BRZ	34.00	71384		
	DBZ	34.00	71378		
	GOL	34.00	71297		
	BLK	34.00	199350		



Door Controls - 5100 Series



Description	Finish	2021 List	Stock	Case Qty.	Box Qty.
5104 Standard Screw Pack 5100 Series	ALM	9.60	87683	80	1
	BRZ	9.60	87619		
	DBZ	9.60	87607		
	GOL	9.60	87089		
	BLK	9.60	75940		
5106 Extra Heavy Duty Parallel Arm 5100 Series	ALM	93.20	71612	10	1
	BRZ	93.20	71144		
	DBZ	93.20	71129		
	GOL	93.20	71121		
	BLK	93.20	199357		
5107 Standard Hold Open Arm 5100 Series	ALM	72.50	65492	10	1
	BRZ	72.50	65430		
	DBZ	72.50	65429		
	GOL	72.50	65422		
	BLK	72.50	199358		
5108 Extra Heavy Duty Hold Open Arm 5100 Series Specify handing when ordering.	ALM	93.20	72742	10	1
	BRZ	93.20	71054		
	DBZ	93.20	71053		
	GOL	93.20	70883		
	BLK	93.20	-		
5109 Drop Plate - Regular Arm Mount w/ Screws 5100 Series	ALM	40.00	62245	10	1
	BRZ	40.00	62028		
	DBZ	40.00	61745		
	GOL	40.00	61741		
	BLK	40.00	100464		
5110 Drop Plate - Parallel Arm Mount w/ Screws 5100 Series	ALM	40.00	61739	10	1
	BRZ	40.00	61735		
	DBZ	40.00	61726		
	GOL	40.00	61725		
	BLK	40.00	199373		
5111 Extra Heavy Duty Parallel Arm Bracket 5100 Series	ALM	17.15	61676	10	1
	BRZ	17.15	61506		
	DBZ	17.15	61432		
	GOL	17.15	61423		
	BLK	17.15	199374		
5112 Long Rod and Shoe 5100 Series For door reveals between 3" - 5".	ALM	17.15	98370	10	1
	BRZ	17.15	97617		
	DBZ	17.15	95821		
	GOL	17.15	95735		
	BLK	17.15	62264		
5113 Blade Stop Spacer	ALM	25.55	95278	15	1
	BRZ	25.55	95276		
	DBZ	25.55	94728		
	GOL	25.55	94438		
	BLK	25.55	199375		
5114 Drop Plate Low Clearance Top Jamb Mount w/ Screws 5100 Series	ALM	40.00	36332	10	1
	BRZ	40.00	36326		
	DBZ	40.00	36325		
	GOL	40.00	36292		
	BLK	40.00	199376		

1. Items with the price in **bold and red** are Quick Ship items and ship in 24 hours.
Please use stock number when ordering. 2. U/M is each unless otherwise noted.



Door Controls - 5100 Series



Description	Finish	2021 List	Stock	Case Qty.	Box Qty.
5115 Drop Plate Top Jamb Mount w/ Screws 5100 Series	ALM	40.00	23471	10	1
	BRZ	40.00	36431		
	DBZ	40.00	36430		
	GOL	40.00	36380		
	BLK	40.00	074966		
5125 Extra Heavy Duty Stop Arm 5100 Series Can be combined with 5950, spring cushion kit.	ALM	93.20	120769	10	1
	BRZ	93.20	120770		
	DBZ	93.20	120771		
	GOL	93.20	120772		
	BLK	93.20	199552		
5909 Parallel Arm Bracket 5100 Series	ALM	8.65	63220	20	1
	BRZ	8.65	63101		
	DBZ	8.65	63100		
	GOL	8.65	63078		
	BLK	8.65	084425		
5935 2" Extra Clearance Bracket 5100 Series	ALM	22.50	129572	36	6
	BRZ	22.50	129574		
	DBZ	22.50	129575		
	GOL	22.50	129576		
	BLK	22.50	-		
5940 SNB Screw Pack, 1-3/4" Door 5100 Series	ALM	9.60	104380	200	1
	BRZ	9.60	104381		
	DBZ	9.60	104382		
	GOL	9.60	104383		
	BLK	9.60	-		
5941 SNB Screw Pack, 1-3/8" Door 5100 Series	ALM	9.60	104384	200	1
	BRZ	9.60	104385		
	DBZ	9.60	104386		
	GOL	9.60	104387		
	BLK	9.60	-		
5942 SNB Screw Pack, 2" Door 5100 Series	ALM	9.60	104388	200	1
	BRZ	9.60	104389		
	DBZ	9.60	104390		
	GOL	9.60	104391		
	BLK	9.60	-		
5943 SNB Screw Pack, 2-1/4" Door 5100 Series	ALM	9.60	104392	200	1
	BRZ	9.60	104393		
	DBZ	9.60	104394		
	GOL	9.60	104395		
	BLK	9.60	-		
5946 Tamper Resistant Torx Screwpack Sex Nuts and Bolts for 1-3/4" (44mm) doors 5100 Series Only	ALM	29.50	148410	1000	1
5950 Spring Cushion Kit 5100/5200/5300 Series	ALM	125.10	118353	10	1
	BRZ	125.10	120777		
	DBZ	125.10	120779		
	GOL	125.10	120780		
	BLK	125.10	199887		



Door Controls - 5100 Series

	Description	Finish	2021	Stock	Case Qty.	Box Qty.
	5954 Extra Heavy Duty Hold Open Cushion Stop Arm 5100 Series Includes 5961 and 5950.	ALM	261.45	118337	10	1
		BRZ	261.45	118338		
		DBZ	261.45	118339		
		GOL	261.45	118340		
		BLK	261.45	-		
	5955 Extra Heavy Duty Cushion Stop Arm 5100 Series Includes 5125 and 5950.	ALM	225.00	118341	10	1
		BRZ	225.00	118342		
		DBZ	225.00	118343		
		GOL	225.00	118344		
		BLK	225.00	-		
	5961 Extra Heavy Duty Hold Open Stop Arm Can be combined with 5950, spring cushion kit.	ALM	186.10	192281	10	1
		BRZ	186.10	192282		
		DBZ	186.10	192283		
		GOL	186.10	192284		
		BLK	186.10	199888		
	5962 5100 Series Plated Metal Cover (Check with factory for availability)	US32D	207.70	198227	25	1
		ALM / Painted	145.40	144034		
		DBZ / Painted	145.40	144035		
		BLK/Painted	145.40	-		
	2-659-0145 Non Hold Open Stop Track Arm 5100 Series	ALM	90.20	72256	10	1
	2-659-0144 Non Hold Open Stop Track Arm 5100 Series	BRZ	90.20	72252		
	2-659-0143 Non Hold Open Stop Track Arm 5100 Series	DBZ	90.20	72249		
	2-659-0142 Non Hold Open Stop Track Arm 5100 Series	GOL	90.20	72246		
	2-659-0137 Hold Open Stop Track Arm 5100 Series	ALM	104.00	190571	10	1
	2-659-0136 Hold Open Stop Track Arm 5100 Series	BRZ	104.00	72215		
	2-659-0135 Hold Open Stop Track Arm 5100 Series	DBZ	104.00	72207		
	2-659-0134 Hold Open Stop Track Arm 5100 Series	GOL	104.00	72196		
	2-659-0203 Double Egress Non Hold Open Stop Track Arm 5100 Series	ALM	129.40	167865	10	1
2-659-0204 Double Egress Non Hold Open Stop Track Arm 5100 Series	BRZ	129.40	167866			

1. Items with the price in **bold and red** are Quick Ship items and ship in 24 hours.
Please use stock number when ordering. 2. U/M is each unless otherwise noted.



Door Controls - 5100 Series

Description	Header 1	Finish	Year	Stock	Case Qty.	Box Qty.
2-659-0205 Double Egress Non Hold Open Stop Track Arm 5100 Series		DBZ	129.40	167867		
2-659-0206 Double Egress Non Hold Open Stop Track Arm 5100 Series		GOL	129.40	167868		
2-659-0207 Double Egress Hold Open Stop Track Arm 5100 Series		ALM	148.55	167869	10	1
2-659-0208 Double Egress Hold Open Stop Track Arm 5100 Series		BRZ	148.55	167870		
2-659-0209 Double Egress Hold Open Stop Track Arm 5100 Series		DBZ	148.55	167871		
2-659-0210 Double Egress Hold Open Stop Track Arm 5100 Series		GOL	148.55	167873		

Track arms only available in painted finishes shown



Door Controls - 5200 Series



Description	Finish	2021	Stock	Case Qty.	Box Qty.
5200 Series	ALM	243.90	126476	6	1
Grade 1	BRZ	243.90	126478		
Adjustable sizes 1-6	DBZ	243.90	126477		
	GOL	243.90	126479		
	BLK	243.90	199553		

ADA (Barrier Free) Door Closers:

Any certified BHMA/ANSI A156.4 door closer, regardless of manufacturer, that is installed and adjusted based on ADA or other reduced opening force requirements may not provide sufficient power to reliably close and latch a door.

If arms are ordered separately, there will be a significant difference in price than if purchased with a closer as a complete assembly. Adders are listed below. Add the list price of the option to the list price of the closer and take standard discounts.

Delayed Action Valve	17.70
Lead Lined Cover	111.40
Check with factory for pricing and availability of plated products.	POA

Closers with non-standard arms

5200 Series 1-6 Closer, 5203 tri-pack arm, slim line plastic cover	ALM	243.90	145551
	BRZ	243.90	166442
	DBZ	243.90	149176
	GOL	243.90	151746
	BLK	243.90	199553
5200 Series 1-6 Closer, 5910 hold open arm, plastic cover	ALM	283.65	145539
	BRZ	283.65	145540
	DBZ	283.65	145541
	GOL	283.65	145542
5200 Series 1-6 Closer, 5906 extra heavy duty hold open stop arm, plastic cover	ALM	341.70	145552
	BRZ	341.70	145556
	DBZ	341.70	145557
	GOL	341.70	145558
5200 Series 1-6 Closer, 5907 extra heavy duty stop arm, plastic cover	ALM	292.95	145560
	BRZ	292.95	145561
	DBZ	292.95	145562
	GOL	292.95	145563
5200 Series 1-6 Closer, 5911 extra heavy duty arm, plastic cover	ALM	309.05	149447
	BRZ	309.05	154453
	DBZ	309.05	148832
	GOL	309.05	155891
5200 Series 1-6 Closer, 5912 extra heavy duty hold open arm, plastic cover (left hand)	ALM	280.05	148835
	BRZ	280.05	163413
	DBZ	280.05	153689
	GOL	280.05	156741
5200 Series 1-6 Closer, 5912 extra heavy duty hold open arm, plastic cover (right hand)	ALM	280.05	148839
	BRZ	280.05	163414
	DBZ	280.05	153858
	GOL	280.05	156742
5200 Series 1-6 Closer, 5956 extra heavy duty hold open cushion stop arm, plastic cover	ALM	434.95	149802
	BRZ	434.95	151691
	DBZ	434.95	149732
	GOL	434.95	162296

1. Items with the price in **bold and red** are Quick Ship items and ship in 24 hours.
Please use stock number when ordering. 2. U/M is each unless otherwise noted.











Door Controls - 5200 Series

Description	Finish	2021	Stock	Case Qty.	Box Qty.
5200 Series 1-6 Closer, 5957 extra heavy duty cushion stop arm, plastic cover	ALM	394.65	149011		
	BRZ	394.65	162252		
	DBZ	394.65	148977		
	GOL	394.65	162991		
5200 Closer w/ Non Hold Open Stop Track Arm	ALM	290.55	166333	10	1
	BRZ	290.55	166354		
	DBZ	290.55	166334		
	GOL	290.55	167045		
5200 Closer w/ Hold Open Stop Track Arm	ALM	304.40	166339	10	1
	BRZ	304.40	167223		
	DBZ	304.40	166341		
	GOL	304.40	167224		
5200 Closer w/ Double Egress Non Hold Open Stop Track Arm	ALM	334.35	166350	10	1
	BRZ	334.35	167241		
	DBZ	334.35	166351		
	GOL	334.35	167242		
5200 Closer w/ Double Egress Hold Open Stop Track Arm	ALM	320.50	166346	10	1
	BRZ	320.50	167237		
	DBZ	320.50	166347		

Description	Finish	2021	Stock	Case Qty.	Box Qty.
5201 5200 Series Closer Body Only Adjustable sizes 1-6	ALM	172.10	148807	6	1
	BRZ	172.10	148809		
	DBZ	172.10	148808		
	GOL	172.10	148810		
	BLK	172.10	199708		
5202 Full Plastic Cover 5200 Series	ALM	17.15	88651	25	1
	BRZ	17.15	88532		
	DBZ	17.15	88355		
	GOL	17.15	88343		
	BLK	17.15	199709		
5203 Main Arm Assembly 5200 Series	ALM	34.00	71694	8	1
	BRZ	34.00	71296		
	DBZ	34.00	70681		
	GOL	34.00	71271		
	BLK	34.00	75941		
5204 Standard Screw Pack 5200 Series	ALM	9.90	72358	80	1
	BRZ	9.90	72236		
	DBZ	9.90	72228		
	GOL	9.90	70684		
	BLK	9.90	75941		
5900 Parallel Arm Bracket 5200/5300/5400 Series	ALM	8.65	99140	120	1
	BRZ	8.65	99138		
	DBZ	8.65	99135		
	GOL	8.65	99134		
	BLK	8.65	-		



Door Controls - 5200 Series

	Description	Finish	2021	Stock	Case Qty.	Box Qty.
	5902 SNB Screw Pack, 1-3/4" Door 5200/5300/5400 Series	ALM	9.90	99129	200	1
		BRZ	9.90	99128		
		DBZ	9.90	99127		
		GOL	9.90	99126		
		BLK	9.90	-		
	5903 SNB Screw Pack, 1-3/8" Door 5200/5300/5400 Series	ALM	9.90	99125	200	1
		BRZ	9.90	99124		
		DBZ	9.90	99123		
		GOL	9.90	99122		
		BLK	9.90	-		
	5904 SNB Screw Pack, 2" Door 5200/5300/5400 Series	ALM	9.90	99121	200	1
		BRZ	9.90	99118		
		DBZ	9.90	99117		
		GOL	9.90	99116		
		BLK	9.90	-		
	5905 SNB Screw Pack, 2-1/4" Door 5200/5300/5400 Series	ALM	9.90	99115	200	1
		BRZ	9.90	99114		
		DBZ	9.90	99113		
		GOL	9.90	99112		
		BLK	9.90	-		
	5906 Extra Heavy Duty Hold Open Stop Arm 5200/5300 Series Can be combined with 5950, spring cushion kit.	ALM	186.10	14583	10	1
		BRZ	186.10	14582		
		DBZ	186.10	14578		
		GOL	186.10	14570		
		BLK	186.10	199865		
	5907 Extra Heavy Duty Stop Arm 5200/5300 Series Can be combined with 5950, spring cushion kit.	ALM	93.20	14595	10	1
		BRZ	93.20	14591		
		DBZ	93.20	14587		
		GOL	93.20	14586		
		BLK	93.20	199866		
	5908 Long Rod and Shoe 5200/5300 Series	ALM	17.15	35989	25	1
		BRZ	17.15	35988		
		DBZ	17.15	35941		
		GOL	17.15	35929		
		BLK	17.15	-		
	5910 Standard Hold Open Arm 5200/5300 Series If ordered separately 5914, Rev 1 needed for parallel mount	ALM	74.60	191400	10	1
		BRZ	74.60	191402		
		DBZ	74.60	191401		
		GOL	74.60	191403		
		BLK	74.60	199868		
	5911 Extra Heavy Duty Arm 5200/5300 Series	ALM	93.20	73657		
		BRZ	93.20	73656		
		DBZ	93.20	73607		
		GOL	93.20	73487		
		BLK	93.20	199884		
	5912 Extra Heavy Duty Hold Open Arm 5200/5300 Series Specify handing when ordering.	ALM	93.20	73446	10	1
		BRZ	93.20	73317		
		DBZ	93.20	73347		
		GOL	93.20	73283		
		BLK	93.20	-		

1. Items with the price in **bold and red** are Quick Ship items and ship in 24 hours.
Please use stock number when ordering. 2. U/M is each unless otherwise noted.



Door Controls - 5200 Series



Description	Finish	2021	Stock	Case Qty.	Box Qty.
5913 Blade Stop Spacer 5200/5300/5400 Series	ALM	26.30	73268	15	1
	BRZ	26.30	73244		
	DBZ	26.30	73076		
	GOL	26.30	73074		
	BLK	26.30	068591		



5914 Hold Open Parallel Arm Bracket 5200/5300 Series For standard hold-open arm.	ALM	17.15	171426	60	1
	BRZ	17.15	191431		
	DBZ	17.15	191428		
	GOL	17.15	191432		
	BLK	17.15	71981		



5918 Drop Plate - Top Jamb Narrow Top Rail w/ Mounting Screws 5200 Series For use with slim line or no cover.	ALM	40.00	72262	10	1
	BRZ	40.00	72242		
	DBZ	40.00	72248		
	GOL	40.00	72241		
	BLK	40.00	-		

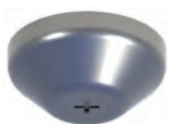

5919 Pinion Cap 5200 Series	ALM	1.90	72138	20	1
	BRZ	1.90	70989		
	DBZ	1.90	70779		
	GOL	1.90	70765		
	BLK	1.90	-		



5920 Slim Line Plastic Cover 5200 Series	ALM	17.15	70962	18	1
	BRZ	17.15	70859		
	DBZ	17.15	70987		
	GOL	17.15	70984		
	BLK	17.15	74835		



5921 Drop Plate Narrow Top Rail w/ Mounting Screws 5200 Series For use with full cover.	ALM	40.00	33996	10	1
	BRZ	40.00	33994		
	DBZ	40.00	33980		
	GOL	40.00	33979		
	BLK	40.00	39740		



5922 Drop Plate - Top Jamb Parallel Arm with Mounting Screws 5200 Series For use with slim line or no cover.	ALM	40.00	33957	10	1
	BRZ	40.00	33943		
	DBZ	40.00	33941		
	GOL	40.00	33940		
	BLK	40.00	82349		



5923 Drop Plate Parallel Arm with Mounting Screws 5200 Series For use with full cover.	ALM	40.00	33947	10	1
	BRZ	40.00	33936		
	DBZ	40.00	33934		
	GOL	40.00	33929		
	BLK	40.00	74827		



5932 Plated Metal Cover (Check with factory for availability) 5200 Series	US32D	169.20	198229	25	1
	ALM (painted)	169.20	191374		
	BLK (painted)	169.20	-		



5936 Extra Clearance Bracket 5200/5300 Series	ALM	22.50	129577	48	8
	BRZ	22.50	129578		
	DBZ	22.50	129579		
	GOL	22.50	129580		
	BLK	22.50	100387		



Door Controls - 5200 Series

	Description	Finish	2021	Stock	Case Qty.	Box Qty.
	5950	ALM	125.10	118353	10	1
	Spring Cushion Kit	BRZ	125.10	120777		
	5100/5200/5300 Series	DBZ	125.10	120779		
		GOL	125.10	120780		
		BLK	125.10	199887		
	5956	ALM	261.45	118345	10	1
	Extra Heavy Duty Hold Open Cushion Stop Arm	BRZ	261.45	118346		
	5200/5300 Series	DBZ	261.45	118347		
	Includes 5906 and 5950.	GOL	261.45	118348		
		BLK	261.45	084427		
	5957	ALM	225.00	118349	10	1
	Extra Heavy Duty Cushion Stop Arm	BRZ	225.00	118350		
	5200/5300 Series	DBZ	225.00	118351		
	Includes 5907 and 5950.	GOL	225.00	118352		
		BLK	225.00	-		
	2-659-0141	ALM	90.20	198619	10	1
	Non Hold Open Stop Track Arm					
	5200/5300 Series					
	2-659-0140	BRZ	90.20	72247		
	Non Hold Open Stop Track Arm					
	5200/5300 Series					
	2-659-0139	DBZ	90.20	72238		
	Non Hold Open Stop Track Arm					
	5200/5300 Series					
	2-659-0138	GOL	90.20	72239		
	Non Hold Open Stop Track Arm					
	5200/5300 Series					
	2-659-0350	ALM	104.00	72197	10	1
	Hold Open Stop Track Arm					
	5200/5300 Series					
	2-659-0351	BRZ	104.00	72198		
	Hold Open Stop Track Arm					
	5200/5300 Series					
	2-659-0352	DBZ	104.00	72192		
	Hold Open Stop Track Arm					
	5200/5300 Series					
	2-659-0353	GOL	104.00	72193		
	Hold Open Stop Track Arm					
	5200/5300 Series					
	2-659-0211	ALM	129.40	167874	10	1
	Double Egress Non Hold Open Stop Track Arm					
	5200 Series					

1. Items with the price in **bold and red** are Quick Ship items and ship in 24 hours.
Please use stock number when ordering. 2. U/M is each unless otherwise noted.

1/1/2021
www.hagerco.com



Door Controls - 5200 Series

Description	Finish	2021	Stock	Case Qty.	Box Qty.
2-659-0212 Double Egress Non Hold Open Stop Track Arm 5200 Series	BRZ	129.40	167875		
2-659-0213 Double Egress Non Hold Open Stop Track Arm 5200 Series	DBZ	129.40	167876		
2-659-0214 Double Egress Non Hold Open Stop Track Arm 5200 Series	GOL	129.40	167877		
2-659-0215 Double Egress Hold Open Stop Track Arm 5200 Series	ALM	148.55	167878	10	1
2-659-0216 Double Egress Hold Open Stop Track Arm 5200 Series	BRZ	148.55	167879		
2-659-0217 Double Egress Hold Open Stop Track Arm 5200 Series	DBZ	148.55	167880		
2-659-0218 Double Egress Hold Open Stop Track Arm 5200 Series	GOL	1448.55	167881		

Track arms only available in painted finishes shown



Door Controls - 5300 Series



Description	Finish	2021	Stock	Case Qty.	Box Qty.
5300 Series	ALM	194.90	145672	6	1
Grade 1	BRZ	194.90	145673		
Adjustable sizes 1-6	DBZ	194.90	145674		
	GOL	194.90	145675		
	BLK	194.90	199793		
ADA (Barrier Free) Door Closers:					
Any certified BHMA/ANSI A156.4 door closer, regardless of manufacturer, that is installed and adjusted based on ADA or other reduced opening force requirements may not provide sufficient power to reliably close and latch a door.					
If arms are ordered separately, there will be a significant difference in price than if purchased with a closer as a complete assembly.					
Adders are listed below. Add the list price of the option to the list price of the closer and take standard discounts.					
Delayed Action Valve		17.70			
Lead Lined Cover		111.40			
Check with factory for pricing and availability of plated products.		POA			
Closers with non-standard arms					
5300 Series 1-6 Closer, 5910 hold open arm, plastic cover	ALM	233.50	145676		
	BRZ	233.50	145677		
	DBZ	233.50	145678		
	GOL	233.50	145679		
5300 Series 1-6 Closer, 5906 extra heavy duty hold open stop arm, plastic cover	ALM	289.85	145681		
	BRZ	289.85	145682		
	DBZ	289.85	145683		
	GOL	289.85	145684		
5300 Series 1-6 Closer, 5907 extra heavy duty stop arm, plastic cover	ALM	242.45	145686		
	BRZ	242.45	174460		
	DBZ	242.45	145687		
	GOL	242.45	164629		
5300 Series 1-6 Closer, 5911 extra heavy duty arm, plastic cover	ALM	242.45	150366		
	BRZ	242.45	173792		
	DBZ	242.45	152815		
	GOL	242.45	-		
5300 Series 1-6 Closer, 5912 extra heavy duty hold open arm, plastic cover (left hand)	ALM	229.20	152972		
	BRZ	229.20	-		
	DBZ	229.20	154681		
	GOL	229.20	-		
5300 Series 1-6 Closer, 5912 extra heavy duty hold open arm, plastic cover (right hand)	ALM	229.20	152973		
	BRZ	229.20	-		
	DBZ	229.20	154682		
	GOL	229.20	-		
5300 Series 1-6 Closer, 5956 extra heavy duty hold open cushion stop arm, plastic cover	ALM	380.75	150916		
	BRZ	380.75	171199		
	DBZ	380.75	160007		
	GOL	380.75	-		
5300 Series 1-6 Closer, 5957 extra heavy duty cushion stop arm, plastic cover	ALM	339.50	149230		
	BRZ	339.50	149807		
	DBZ	339.50	149013		
	GOL	339.50	173080		

1. Items with the price in **bold and red** are Quick Ship items and ship in 24 hours.
Please use stock number when ordering. 2. U/M is each unless otherwise noted.

1/1/2021
www.hagerco.com



Door Controls - 5300 Series



Description	Finish	2021	Stock	Case Qty.	Box Qty.
5300 Closer w/ Non Hold Open Stop Track Arm	ALM	240.60	166335	10	1
	BRZ	240.60	167062		
	DBZ	240.60	166336		
	GOL	240.60	167217		
5300 Closer w/ Hold Open Stop Track Arm	ALM	252.90	166342	10	1
	BRZ	252.90	167225		
	DBZ	252.90	166343		
	GOL	252.90	167234		



Description	Finish	2021	Stock	Case Qty.	Box Qty.
5301 Closer Body Only Adjustable sizes 1-6	ALM	125.40	148811	6	1
	BRZ	125.40	148813		
	DBZ	125.40	148812		
	GOL	125.40	148814		
	BLK	125.40	75827		



5302 Full Plastic Cover 5300 Series	ALM	17.15	88207	25	1
	BRZ	17.15	87873		
	DBZ	17.15	87843		
	GOL	17.15	87785		
	BLK	17.15	78432		



5303 Main Arm Assembly 5300 Series	ALM	34.00	71270	8	1
	BRZ	34.00	71255		
	DBZ	34.00	71254		
	GOL	34.00	71234		
	BLK	34.00	199859		



5304 Standard Screw Pack 5300 Series	ALM	9.90	72356	80	1
	BRZ	9.90	72210		
	DBZ	9.90	72180		
	GOL	9.90	72174		
	BLK	9.90	75942		



5900 Parallel Arm Bracket 5200/5300/5400 Series	ALM	8.65	99140	120	1
	BRZ	8.65	99138		
	DBZ	8.65	99135		
	GOL	8.65	99134		
	BLK	8.65	-		



5901 Pinion Cap 5300/5400 Series	ALM	1.95	99133	200	1
	BRZ	1.95	99132		
	DBZ	1.95	99131		
	GOL	1.95	99130		1
	BLK	1.95	-		



5902 SNB Screw Pack, 1-3/4" Door 5200/5300/5400 Series	ALM	9.90	99129	200	1
	BRZ	9.90	99128		
	DBZ	9.90	99127		
	GOL	9.90	99126		
	BLK	9.90	-		



Door Controls - 5300 Series

Description	Finish	2021	Stock	Case Qty.	Box Qty.
 5903 SNB Screw Pack, 1-3/8" 5200/5300/5400 Series	ALM	9.90	99125	200	1
	BRZ	9.90	99124		
	DBZ	9.90	99123		
	GOL	9.90	99122		
	BLK	9.90	-		
 5904 SNB Screw Pack, 2" Door 5200/5300/5400 Series	ALM	9.90	99121	200	1
	BRZ	9.90	99118		
	DBZ	9.90	99117		
	GOL	9.90	99116		
	BLK	9.90	-		
 5905 SNB Screw Pack, 2-1/4" Door 5200/5300/5400 Series	ALM	9.90	99115	200	1
	BRZ	9.90	99114		
	DBZ	9.90	99113		
	GOL	9.90	99112		
	BLK	9.90	-		
 5906 Extra Heavy Duty Hold Open Stop Arm 5200/5300 Series Can be combined with 5950, spring cushion kit.	ALM	186.10	14583	10	1
	BRZ	186.10	14582		
	DBZ	186.10	14578		
	GOL	186.10	14570		
	BLK	186.10	199865		
 5907 Extra Heavy Duty Stop Arm 5200/5300 Series Can be combined with 5950, spring cushion kit.	ALM	93.20	14595	10	1
	BRZ	93.20	14591		
	DBZ	93.20	14587		
	GOL	93.20	14586		
	BLK	93.20	199866		
 5908 Long Rod and Shoe 5200/5300 Series	ALM	17.15	35989	25	1
	BRZ	17.15	35988		
	DBZ	17.15	35941		
	GOL	17.15	35929		
	BLK	17.15	-		
 5910 Standard Hold Open Arm 5200/5300 Series If ordered separately 5914, Rev 1 needed for parallel mount.	ALM	74.60	191400		
	BRZ	74.60	191402		
	DBZ	74.60	191401		
	GOL	74.60	191403		
	BLK	74.60	199868		
 5911 Extra Heavy Duty Arm 5200/5300 Series	ALM	93.20	73657	10	1
	BRZ	93.20	73656		
	DBZ	93.20	73607		
	GOL	93.20	73487		
	BLK	93.20	199884		
 5912 Extra Heavy Duty Hold Open Arm 5200/5300 Series Specify handing when ordering.	ALM	93.20	73446	10	1
	BRZ	93.20	73317		
	DBZ	93.20	73347		
	GOL	93.20	73283		
	BLK	93.20	-		

1. Items with the price in **bold and red** are Quick Ship items and ship in 24 hours.
 Please use stock number when ordering. 2. U/M is each unless otherwise noted.



Door Controls - 5300 Series

	Description	Finish	2021	Stock	Case Qty.	Box Qty.
	5913 Blade Stop Spacer 5200/5300/5400 Series	ALM	26.30	73268	15	1
		BRZ	26.30	73244		
		DBZ	26.30	73076		
		GOL	26.30	73074		
		BLK	26.30	68591		
	5914 Hold Open Parallel Arm Bracket 5200/5300 Series For standard hold-open arm.	ALM	17.15	191426	60	1
		BRZ	17.15	191431		
		DBZ	17.15	191428		
		GOL	17.15	191432		
		BLK	17.15	71981		
	5915 Drop Plate - OH Holder Narrow Rail w/ Mounting Screws 5300 Series For use with full cover.	ALM	40.00	72754	10	1
		BRZ	40.00	72741		
		DBZ	40.00	72750		
		GOL	40.00	72673		
		BLK	40.00	133059		
	5916 Drop Plate - Narrow Rail Parallel Arm Cover w/ Mounting Screws 5300 Series For use with full cover.	ALM	40.00	72669	10	1
		BRZ	40.00	72500		
		DBZ	40.00	72509		
		GOL	40.00	72468		
		BLK	40.00	100600		
	5917 Drop Plate - Low Clearance Overhead Holder w/ Mounting Screws 5300 Series For use with no cover.	ALM	40.00	72410	10	1
		BRZ	40.00	72281		
		DBZ	40.00	72372		
		GOL	40.00	72264		
		BLK	40.00	100599		
	5936 Extra Clearance Bracket 5200/5300 Series	ALM	22.50	129577	48	1
		BRZ	22.50	129578		
		DBZ	22.50	129579		
		GOL	22.50	129580		
		BLK	22.50	100387		
	5950 Spring Cushion Kit (sold separately) 5100/5200/5300 Series	ALM	125.10	118353	10	1
		BRZ	125.10	120777		
		DBZ	125.10	120779		
		GOL	125.10	120780		
	5956 Extra Heavy Duty Hold Open Cushion Stop Arm 5200/5300 Series Includes 5906 and 5950.	ALM	261.45	118345	10	1
		BRZ	261.45	118346		
		DBZ	261.45	118347		
		GOL	261.45	118348		
		BLK	261.45	084427		
	5957 Extra Heavy Duty Cushion Stop Arm 5200/5300 Series Includes 5907 and 5950.	ALM	225.00	118349	10	1
		BRZ	225.00	118350		
		DBZ	225.00	118351		
		GOL	225.00	118352		
		BLK	225.00	-		
	2-659-0141 Non Hold Open Stop Track Arm 5200/5300 Series	ALM	90.20	198619	10	1
		BRZ	90.20	72247		



Door Controls - 5300 Series



Description	Voltage	Finish	2021	Stock	Case Qty.	Box Qty.
2-659-0139 Non Hold Open Stop Track Arm 5200/5300 Series		DBZ	90.20	72238		
2-659-0138 Non Hold Open Stop Track Arm 5200/5300 Series		GOL	90.20	72239		
2-659-0350 Hold Open Stop Track Arm 5200/5300 Series		ALM	104.00	72197	10	1
2-659-0351 Hold Open Stop Track Arm 5200/5300 Series		BRZ	104.00	72198		
2-659-0352 Hold Open Stop Track Arm 5200/5300 Series		DBZ	104.00	72192		
2-659-0353 Hold Open Stop Track Arm 5200/5300 Series		GOL	104.00	72183		

Track arms only available in painted finishes shown

1. Items with the price in **bold and red** are Quick Ship items and ship in 24 hours.
Please use stock number when ordering. 2. U/M is each unless otherwise noted.



Door Controls - 5400 Series



Description	Size	Finish	2021	Stock	Case Qty.	Box Qty.
5400 Series		ALM	120.30	85450	6	1
Grade 2		DBZ	120.30	85449		
Size 2 - 5		BLK	120.30	36779		
5400 Series Adders:			16.50			
Optional backcheck available (add to list price)						
5401		ALM	92.55	67779	6	1
5400 Series Closer Body Only		DBZ	92.55	76407		
Size 2 - 5		BLK	92.55	76416		
5402		ALM	17.15	77881		
Plastic Cover		DBZ	17.15	77819		
5400 Series						
5403		ALM	30.35	71659	8	1
Main Arm Assembly		DBZ	30.35	71218		
5400 Series		BLK	30.35	-		
5404		ALM	9.40	72336	80	1
Standard Screw Pack		DBZ	9.40	72171		
5400 Series		BLK	9.40	-		



Door Controls - 5400 Series



Description	Size	Finish	2021	Stock	Case Qty.	Box Qty.
5900 Parallel Arm Bracket 5200/5300/5400 Series		ALM	8.65	99140	120	1
		DBZ	8.65	99135		
		BLK	8.65	-		
5901 Pinion Cap 5300/5400 Series		ALM	1.95	99133	200	1
		DBZ	1.95	99131		
		BLK	1.95	-		
5902 SNB Screw Pack, 1-3/4" Door 5200/5300/5400 Series		ALM	9.90	9129	200	1
		DBZ	9.90	9127		
		BLK	9.60	-		
5903 SNB Screw Pack, 1-3/8" Door 5200/5300/5400 Series		ALM	9.90	99125	200	1
		DBZ	9.90	99123		
		BLK	9.90	-		
5904 SNB Screw Pack, 2" Door 5200/5300/5400 Series		ALM	9.90	99121	200	1
		DBZ	9.90	99117		
		BLK	9.90	-		
5905 SNB Screw Pack, 2-1/4" Door 5200/5300/5400 Series		ALM	9.90	99115	200	1
		DBZ	9.90	99113		
		BLK	9.90	-		
5913 Blade Stop Spacer 5200/5300/5400 Series		ALM	26.30	73268	15	1
		DBZ	26.30	73076		
		BLK	26.30	-		

1. Items with the price in **bold and red** are Quick Ship items and ship in 24 hours.
Please use stock number when ordering. 2. U/M is each unless otherwise noted.



Door Controls - Electromagnetic Holders

	Description	Header 1	Finish	Year	Stock	Case Qty.	Box Qty.	
	380F Electromagnetic Door Holder Flush Mount	12 & 24	US3	260.35	122598	25	1	
			L2	260.35	113307			
			LS	260.35	107216			
		24 & 120	US3	260.35	-			
			L2	260.35	143678			
			LS	260.35	107443			
		24 & 220	US3	260.35	142090			
			L2	260.35	-			
			LS	260.35	124474			
	380G Electromagnetic Door Holder Floor Mount (Single Door)	12 & 24	US3	393.80	133360	18	1	
			L2	393.80	-			
			LS	393.80	133362			
		24 & 120	US3	393.80	-			
			L2	393.80	-			
			LS	393.80	111432			
		24 & 220	US3	393.80	-			
			L2	393.80	122342			
			LS	393.80	139500			
	380H Electromagnetic Door Holder Floor Mount (Double Door)	12 & 24	US3	460.55	-	6	1	
			L2	460.55	-			
			LS	460.55	-			
		24 & 120	US3	460.55	-			
			L2	460.55	-			
			LS	460.55	114881			
		24 & 220	US3	460.55	-			
			L2	460.55	-			
			LS	460.55	-			
	380R Electromagnetic Door Holder Recessed Mount	12 & 24	US3	260.35	129952	25	1	
			L2	260.35	130390			
			LS	260.35	107442			
		24 & 120	US3	260.35	-			
			L2	260.35	-			
			LS	260.35	107446			
		24 & 220	US3	260.35	-			
			L2	260.35	-			
			LS	260.35	141037			
	380S Electromagnetic Door Holder Surface Mount	12 & 24	US3	287.00	114503	25	1	
			L2	287.00	113961			
			LS	287.00	107441			
		24 & 120	US3	287.00	120377			
			L2	287.00	116868			
			LS	287.00	107444			
		24 & 220	US3	287.00	-			
			L2	287.00	139499			
			LS	287.00	-			



Door Controls - Electromagnetic Holders

Description	Header 1	Finish	Year	Stock	Case Qty.	Box Qty.
 381A Adjustable Extension Rods	1-1/2"	US3	21.50	107528	25	1
		L2	21.50	107529		
		LS	21.50	107527		
	2"	US3	22.75	107532		
		L2	22.75	107533		
		LS	22.75	107530		
	4"	US3	25.35	107535		
		L2	25.35	107536		
		LS	25.35	107534		
 381B Surface Back Box	4"	US3	40.05	107547	50	1
		L2	40.05	107548		
		LS	40.05	107545		
 381C Catch Disc	2"	US3	26.80	107550	25	1
		L2	26.80	107551		
		LS	26.80	107549		
 381D Drilling Fixture	4"	-	51.50	166584	1	1
 381E Extension Rods	1/2"	US3	17.45	107450	25	1
		L2	17.45	107451		
		LS	17.45	107449		
	1"	US3	18.80	107453		
		L2	18.80	107452		
		LS	18.80	107455		
	1-1/2"	US3	20.10	107458		
		L2	20.10	107460		
		LS	20.10	107457		
	2"	US3	21.50	107467		
		L2	21.50	107468		
		LS	21.50	107462		
	3"	US3	22.75	107489		
		L2	22.75	107490		
		LS	22.75	107488		
4"	US3	24.05	107492			
	L2	24.05	107493			
	LS	24.05	107491			
 381H Hardware Package	4"	-	22.75	165884	25	1
 381S Catch Plate Assembly	4"	US3	66.75	107543	50	1
		L2	66.75	107544		
		LS	66.75	107542		

1. Items with the price in **bold and red** are Quick Ship items and ship in 24 hours.
 Please use stock number when ordering. 2. U/M is each unless otherwise noted.



Door Controls - Electromagnetic Holders



Description	Header 1	Finish	Year	Stock	Case Qty.	Box Qty.
381W Extension Wrenches (2 pcs.)	4"	-	5.35	107552	25	1



Door Controls - Overhead Door Holders and Stops



Description	Material	Finish	2021	Stock	Case Qty.	Box Qty.
6015 Series						
Medium Duty Surface Mount						
Friction	Stainless steel	US32D/630	170.15	140725	6	1
Size 1	Steel	US10B/640	170.15	140826		
18" - 33" Frame Opening		US3/632	170.15	147008		
		ALM/powder coated	124.85	140886		
Friction	Stainless steel	US32D/630	170.15	140726	6	1
Size 2	Steel	US10B/640	170.15	140827		
33" - 51" Frame Opening		US3/632	170.15	147010		
		ALM/powder coated	124.85	140887		

6015 Series						
Medium Duty Concealed Mount						
Friction	Stainless steel	US32D/630	170.15	140731	6	1
Size 1	Steel	US10B/640	170.15	140832		
18" - 33" Frame Opening		US3/632	170.15	147009		
		ALM/powder coated	124.85	140892		
Friction	Stainless steel	US32D/630	170.15	140732	6	1
Size 2	Steel	US10B/640	170.15	140833		
33" - 51" Frame Opening		US3/632	170.15	147011		
		ALM/powder coated	124.85	140893		



6016 Series						
Medium Duty Surface Mount						
Stop ONLY	Stainless steel	US32D/630	170.15	140720	6	1
Size 1	Steel	US10B/640	170.15	140822		
18" - 33" Frame Opening		US3/632	170.15	147000		
		ALM/powder coated	124.85	140882		
Stop ONLY	Stainless steel	US32D/630	170.15	140721	6	1
Size 2	Steel	US10B/640	170.15	140823		
33" - 51" Frame Opening		US3/632	170.15	147002		
		ALM/powder coated	124.85	140883		

6016 Series						
Medium Duty Concealed Mount						
Stop ONLY	Stainless steel	US32D/630	170.15	140727	6	1
Size 1	Steel	US10B/640	170.15	140828		
18" - 33" Frame Opening		US3/632	170.15	147001		
		ALM/powder coated	124.85	140888		
Stop ONLY	Stainless steel	US32D/630	170.15	140728	6	1
Size 2	Steel	US10B/640	170.15	140829		
33" - 51" Frame Opening		US3/632	170.15	147003		
		ALM/powder coated	124.85	140889		

1. Items with the price in **bold and red** are Quick Ship items and ship in 24 hours.
Please use stock number when ordering. 2. U/M is each unless otherwise noted.



Door Controls - Overhead Door Holders and Stops



Description	Material	Finish	2021	Stock	Case Qty.	Box Qty.
6017 Series						
Medium Duty Surface Mount						
Hold Open	Stainless steel	US32D/630	170.15	140722	6	1
Size 1	Steel	US10B/640	170.15	140824		
18" - 33" Frame Opening		US3/632	170.15	147004		
		ALM/powder coated	124.85	140884		
Hold Open	Stainless steel	US32D/630	170.15	140723	6	1
Size 2	Steel	US10B/640	170.15	140825		
33" - 51" Frame Opening		US3/632	170.15	147006		
		ALM/powder coated	124.85	140885		
6017 Series						
Medium Duty Concealed Mount						
Hold Open	Stainless steel	US32D/630	170.15	140729	6	1
Size 1	Steel	US10B/640	170.15	140830		
18" - 33" Frame Opening		US3/632	170.15	147005		
		ALM/powder coated	124.85	140890		
Hold Open	Stainless steel	US32D/630	170.15	140730	6	1
Size 2	Steel	US10B/640	170.15	140831		
33" - 51" Frame Opening		US3/632	170.15	147007		
		ALM/powder coated	124.85	140891		
6000 Series Accessories						
	2-659-0101	US26D	13.70	141691		
Surface Mounted End Cap and	2-659-0102	US10B	13.70	141692		
Spring Replacement Kit	2-659-0103	US3	13.70	141693		
6000 Series Accessories						
	2-659-0104	-	13.70	141695		
Concealed Mounted End Cap and						
Spring Replacement Kit						
6000 Series Accessories						
	2-659-0105	-	20.50	141696		
Hold Open Replacement Kit						
6000 Series Accessories						
	2-659-0106	-	20.50	141697		
Friction Replacement Kit						
6000 Series Screwpacks						
	2-659-0098	US26D	10.30	141688		
Standard screwpack includes	2-659-0099	US10B	10.30	141689		
machine screws, wood screws, sex	2-659-0100	US3	10.30	141690		
nuts & bolts for 1-3/4" doors, arm						
set screws, Allen wrench, for both						
concealed and surface mounted						
6000 Series Screwpacks						
	2-659-0107	US26D	8.05	141698		
SNB screwpack includes sex nuts	2-659-0108	US10B	8.05	141699		
and bolts for 1-3/8" doors	2-659-0109	US3	8.05	141700		
6000 Series Screwpacks						
	2-659-0110	US26D	8.05	141701		
SNB screwpack includes sex nuts	2-659-0111	US10B	8.05	141702		
and bolts for 2" doors	2-659-0112	US3	8.05	141703		



Door Controls - Overhead Door Holders and Stops



Description	Material	Finish	2021	Stock	Case Qty.	Box Qty.
6000 Series Screwpacks	2-659-0113	US26D	8.05	141704		
SNB screwpack includes sex nuts and bolts for 2-1/4" doors	2-659-0114	US10B	8.05	141705		
	2-659-0115	US3	8.05	141706		



Description	Material	Finish	2021	Stock	Case Qty.	Box Qty.
7015 Series Heavy Duty Surface Mount						
Friction	Stainless steel	US32D/630	323.30	140712	6	1
Size 1	Steel	US10B/640	323.30	140814		
23" - 39" Frame Opening		US3/632	323.30	147263		
		ALM/powder coated	260.95	140874		
Friction	Stainless steel	US32D/630	323.30	140713	6	1
Size 2	Steel	US10B/640	323.30	140815		
39" - 54" Frame Opening		US3/632	323.30	147265		
		ALM/powder coated	260.95	140875		

7015 Series Heavy Duty Concealed Mount						
Friction	Stainless steel	US32D/630	323.30	140718	6	1
Size 1	Steel	US10B/640	323.30	140820		
23" - 39" Frame Opening		US3/632	323.30	147264		
		ALM/powder coated	260.95	140880		
Friction	Stainless steel	US32D/630	323.30	140719	6	1
Size 2	Steel	US10B/640	323.30	140821		
39" - 54" Frame Opening		US3/632	323.30	147266		
		ALM/powder coated	260.95	140881		



7016 Series Heavy Duty Surface Mount						
Stop ONLY	Stainless steel	US32D/630	323.30	140680	6	1
Size 1	Steel	US10B/640	323.30	140805		
23" - 39" Frame Opening		US3/632	323.30	147252		
		ALM/powder coated	260.95	140870		
Stop ONLY	Stainless steel	US32D/630	323.30	140701	6	1
Size 2	Steel	US10B/640	323.30	140807		
39" - 54" Frame Opening		US3/632	323.30	147255		
		ALM/powder coated	260.95	140871		



7016 Series Heavy Duty Concealed Mount						
Stop ONLY	Stainless steel	US32D/630	323.30	140714	6	1
Size 1	Steel	US10B/640	323.30	140816		
23" - 39" Frame Opening		US3/632	323.30	147254		
		ALM/powder coated	260.95	140876		
Stop ONLY	Stainless steel	US32D/630	323.30	140715	6	1
Size 2	Steel	US10B/640	323.30	140817		
39" - 54" Frame Opening		US3/632	323.30	147256		
		ALM/powder coated	260.95	140877		

1. Items with the price in **bold and red** are Quick Ship items and ship in 24 hours.
Please use stock number when ordering. 2. U/M is each unless otherwise noted.



Door Controls - Overhead Door Holders and Stops



Description	Material	Finish	2021	Stock	Case Qty.	Box Qty.
7017 Series Heavy Duty Surface Mount						
Hold Open	Stainless steel	US32D/630	323.30	140710	6	1
Size 1	Steel	US10B/640	323.30	140810		
23" - 39" Frame Opening		US3/632	323.30	147257		
		ALM/powder coated	260.95	140872		
Hold Open	Stainless steel	US32D/630	323.30	140711	6	1
Size 2	Steel	US10B/640	323.30	140813		
39" - 54" Frame Opening		US3/632	323.30	147261		
		ALM/powder coated	260.95	140873		
7017 Series Heavy Duty Concealed Mount						
Hold Open	Stainless steel	US32D/630	323.30	140716	6	1
Size 1	Steel	US10B/640	323.30	140818		
23" - 39" Frame Opening		US3/632	323.30	147258		
Hold Open	Stainless steel	US32D/630	323.30	140717	6	1
Size 2	Steel	US10B/640	323.30	140819		
39" - 54" Frame Opening		US3/632	323.30	147264		
7000 Series Accessories						
Surface Mounted End Cap and Spring Replacement Kit	2-659-0119	US26D	18.75	141711		
	2-659-0120	US10B	18.75	141712		
	2-659-0121	US3	18.75	141713		
7000 Series Accessories						
Concealed Mounted End Cap and Spring Replacement Kit	2-659-0122	-	18.75	141714		
7000 Series Accessories						
Hold Open Replacement Kit	2-659-0123	-	22.70	141715		
7000 Series Accessories						
Friction Replacement Kit	2-659-0124	-	22.70	141716		
7000 Series Screwpacks						
Standard screwpack includes machine screws, wood screws, sex nuts & bolts for 1-3/4" doors, arm set screws, Allen wrench, for both concealed and surface mounted	2-659-0116	US26D	15.65	141707		
	2-659-0117	US10B	15.65	141708		
	2-659-0118	US3	15.65	141709		
7000 Series Screwpacks						
SNB screwpack includes sex nuts and bolts for 1-3/8" doors	2-659-0125	US26D	11.35	141717		
	2-659-0126	US10B	11.35	141718		
	2-659-0127	US3	11.35	141719		
7000 Series Screwpacks						
SNB screwpack includes sex nuts and bolts for 2" doors	2-659-0128	US26D	11.35	141720		
	2-659-0129	US10B	11.35	141721		
	2-659-0130	US3	11.35	141722		

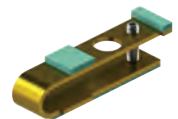

Door Controls - Overhead Door Holders and Stops



Description	Material	Finish	2021	Stock	Case Qty.	Box Qty.
7000 Series Screwpacks	2-659-0131	US26D	11.35	141723		
SNB screwpack includes sex nuts	2-659-0132	US10B	11.35	141724		
and bolts for 2-1/4" doors	2-659-0133	US3	11.35	141725		

1. Items with the price in **bold and red** are Quick Ship items and ship in 24 hours.
Please use stock number when ordering. 2. U/M is each unless otherwise noted.





H **HAGER**[®]
COMPANIES

TABLE OF CONTENTS

A		L	
Actuators	17-19	8300 Series Low Energy Power Operators	15-16
Adjustable Angle Bracket (2941/2942)	6	8400 Series Low Energy Power Operators	12-14
Angle Brackets (2950 Series)	9	M	
Armature Mounting Plates (2950 Series).....	7-8	Magnetic Locks (2941/2942 Series).....	6
Arm Assemblies (8300 Series)	16	Magnetic Locks (2950 Series).....	7-9
Arm Assemblies (8400 Series)	13	Magnetic Shear Locks (2961/2965).....	9
B		Magnetic Switches	11
Battery Backup (8300 Series).....	15	O	
Bollard Posts.....	19	On-Board Power Supply (8400 Series)	14
C		Outdoor Shrouds.....	4,11
Concealed Magnetic Contact	11	P	
Coordinator Mounting Bracket (2950 Series)	8	Power Supply.....	3-4
Covers (8400 Series).....	13-14	Power Transfers	11
D		Pressure Sense Bars.....	10
Delayed Egress Magnetic Lock.....	9-10	Proximity Cards & Keys... ..	4-5
Door Prop Alarms.....	3	Pedestrian Presence Sensors	21
Drop Plates (8400 Series)	13	R	
E		Relay & Door Sequencer	20
Egress Sensors.....	11	Relay Board (8400 Series).....	14
Electric Strikes	5-6	S	
Emergency Door Release.....	11	Spacer Brackets (2950 Series)	7
Exit Switches	10	Spindles (8300 Series)	16
F		Spindles (8400 Series).....	13
Filler Bars (2941/2942 Series)	6	T	
Filler Bars (2950 Series)	8	Top Jamb Kits (2941/2942)	6
G		Top Jamb Kits (2950 Series)	7
Gang Boxes	11	U	
Glass Door Kits (2941/2942)	6	Universal Brackets (2950 Series).....	7
Glass Door Kits (2950 Series).....	7	Underdesk Switch	11
H		W	
Handheld Programmer (8300 Series)	16	Wireless Receiver	20
K		Wireless Transmitters	20
Key Switch.....	3		
Keypads.....	4		



Electrified Products

LEAD TIMES

Stock items will typically ship in five working days or less from the order entry date. Made-to-order items will typically ship in 15 working days depending on seasonal volume and order complexity. Special orders including industrials, special machining, and large quantities may need to be scheduled. The anticipated ship date will be included with each order acknowledgment. Please contact Customer Service if product availability is in question.

QUICK SHIP

Products denoted with **red and bold** pricing are available to order through the Quick Ship program and ship within 24 hours. When ordering these products please visit www.hagerco.com and log in to MyHager to access the 'Quick Ship' portal. Due to the promptness of the fulfillment process, Quick Ship orders are non-cancellable.

CANCELLATION NOTIFICATION

Cancellation for made-to-order items must be communicated within 48 hours of order placement.





Description	Finish	2021 List	Stock No.	Case Qty.
29KS ASD Key switch - Alternate, SPDT	US32D	105.85	156361	12
29KS MSD Key switch - Momentary, SPDT	US32D	105.85	156367	12
29KS ADD Key switch - Alternate, DPDT	US32D	122.60	156366	12
29KS MDD Key switch - Momentary, DPDT	US32D	117.05	156367	12
Options: Red LED \$21.65 list price adder Green LED \$21.65 list price adder 2 LED's \$27.05 list price adder				
29EA NS Door Prop Alarm, Single Gang Mount, No Key Switch		303.50	199478	
29EA KS Door Prop Alarm, Double Gang Mount, Key Switch		427.70	199474	
29EA MKNC Door Prop Alarm, Double Gang Mount, Mortise Cylinder Switch		386.25	199473	
2901 For use with 4500 Series electric latch retraction battery back up option available		614.30	114909	
2902 For use with 4500 Series electric latch retraction in a day/night mode of operation, battery backup option available		677.95	114990	
2903 Provides 24 volt DC power for Fail Safe or Fail Secure locking devices and interface with building alarm controls, card readers, keypads, and other door controls.		529.45	114455	
2904 Provides 24 volt DC power and control for opening with an electrified locking device and automatic door operator		561.25	136899	
2908 Provides up to 1 amp of 12 or 24 volt DC power for all Hager Electrified Products except (ELR)		366.05	149931	1
2909 Provides up to 2 amps of 12 or 24 volt DC power for all Hager Electrified Products		558.10	177262	



Electrified Products

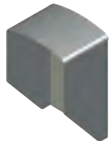

Description	Finish	2021 List	Stock No.	Case Qty.
2910 Provides up to 4 amps of 12 or 24 volt DC power for all Hager Electrified Products		856.65	198523	
2911 Provides up to 6 amps of 12 or 24 volt DC power for all Hager Electrified Products		1,000.10	198524	
2-679-0661 5 Amp hour battery backup for use with 2908 & 2909		49.05	153208	
2-679-0662 12 VDC output regulator module for use with 2908 & 2909		62.90	159033	
2-679-0664 Universal Relay Module for use with 2908 & 2909		120.80	156812	
2-679-0703 Electric Retraction Sequencer for use with 2908 & 2909		182.55	177267	
2-679-0704 Access Control Module for use with 2908 & 2909		199.50	177263	
2-679-0705 16 AMP Power Booster for use with 2909 only		182.55	177264	
2-679-0706 Power Supply Remote Monitoring Module for use with 2908 & 2909		265.25	177266	
2-679-0708 Underdesk Push Switch		115.00	176289	
2915 Heavy Duty Keypad - Indoor 500 users, 4-6 digit PIN codes 12/24V AC/DC	US3	239.55	150749	12
	US4	239.55	150750	
	US10B	239.55	150751	
	US26	239.55	150752	
	US32D	195.00	149619	
2916 Heavy Duty Keypad - Outdoor 500 users, 4-6 digit PIN Codes 12/24V AC/DC	32D	254.65	173204	8
2916P Heavy Duty Keypad / Prox-Outdoor 500 users, 4-6 digit PIN codes 12/24V AC/DC	32D	700.15	189700	8
2-679-0669 Shroud Cover	-	163.75	176541	
2-679-0700 Surface Mount Box	-	32.95	172698	
2-679-0021 HID ProxCard II, 25 Cards	-	195.00	149627	
2-679-0022 HID ProxCard II, 100 Cards	-	779.80	153893	





Description	Finish	2021 List	Stock No.	Case Qty.
2-679-0023 HID ProxKey, 10 Key fobs	-	156.00	150753	
2-679-0024 HID ProxKey, 100 Key fobs	-	1,559.55	153894	
2925 Electric Strike - 5/8" Latch Field Reversible Failsafe/Failsecure 12/24VDC 4-7/8" Sq Corner Stainless Steel Faceplate	US32D	133.70	149637	8
2928 SC Electric Strike - 1/2" to 3/4" latch Failsafe/Failsecure 12/24V AC/DC 4-7/8" Sq Corner Stainless Steel Faceplate	US32D	217.25	149638	8
2928 RC Electric Strike - 1/2" to 3/4" latch Failsafe/Failsecure 12/24V AC/DC 4-7/8" Radius Corner Faceplate	ALM	189.45	150333	8
2928 6R Electric Strike - 1/2" to 3/4" latch Failsafe/Failsecure 12/24V AC/DC 6-7/8" Radius Corner Faceplate	ALM	195.00	154920	8
2928 7R Electric Strike - 1/2" to 3/4" latch Failsafe/Failsecure 12/24V AC/DC 7-15/16" Radius Corner Faceplate	ALM	200.55	173212	8
Options: Keeper open/closed status \$48.70 list price adder Note: Additional finishes available for 2928. Inquire with Hager Customer Service for pricing.				
2930 CYL Electric Strike - Cylindrical lock Dual Voltage 12/24VDC ANSI/BHMA A156.31 Grade 1 UL Listed 3-hour fire rated Non-handed	US4 US10 US10B US26 US26D US32D	562.60 562.60 562.60 562.60 562.60 512.45	175715 156216 160255 175075 149642 149641	12
2930 MOR Electric Strike - Mortise lock Dual Voltage 12/24VDC ANSI/BHMA A156.31 Grade 1 UL Listed 3-hour fire rated Non-handed	US4 US10 US10B US26 US26D US32D	584.85 584.85 584.85 584.85 584.85 540.30	167282 160328 163253 149646 149645	12



Electrified Products

Description	Finish	2021 List	Stock No.	Case Qty.
2930 MDB Electric Strike - Mortise lock w/ Deadbolt Dual Voltage 12/24VDC ANSI/BHMA A156.31 Grade 1 UL Listed 3-hour fire rated Non-handed	US4 US10 US10B US26 US26D US32D	612.70 612.70 612.70 612.70 612.70 557.00	 175970 176007 149649 149648	12
Options:	Latchbolt Monitor (LBM) \$73.00 list price adder Door secure monitor (DSM) \$150.45 list price adder Deadbolt monitor - (DBM) LH \$78.00 list price adder Deadbolt monitor - (DBM) RH \$78.00 list price adder			
2-679-0028 Buzzer 12/24V AC/DC operation for 2925/2928/2930	-	44.15	153474	12
2-679-0029 Rectifier for AC operation for 2925/2928/2930	-	24.55	155676	12
2941 Magnetic Lock 600 lb. holding force 12/24VDC, field selectable	ALM	250.70	149650	4
2942 Magnetic Lock 1200 lb. holding force 12/24VDC, field selectable	ALM	300.85	149652	4
2-679-0100 Top Jamb Kit for 2942	ALM	98.10	149653	8
2-679-0101 Top Jamb Kit for 2941	ALM	98.10	149654	8
2-679-0102 Glass Door Kit for 2942	ALM	49.05	149655	8
2-679-0103 Glass Door Kit for 2941	ALM	49.05	149656	8
2-679-0104 Adjustable Angle Bracket for 2942 10-1/2" x 1-3/4" x 3-1/8"	ALM	36.80	149657	8
2-679-0106 Angle bracket for 2942 (Cut for use with 2941) 10-1/2" x 1-1/2" x 3/4"	ALM	24.55	149659	8
2-679-0107 Filler bar for 2942 (Cut for use with 2941) 5/8" x 3/4" x 10-1/2"	ALM	18.45	149660	6
2-679-0108 Filler bar for 2942 (Cut for use with 2941) 3/4" x 3/4" x 10-1/2"	ALM	18.45	149661	6





Description	Finish	2021 List	Stock No.	Case Qty.
2951 Magnetic Lock 1,650 lb. holding force Surface mount - single 12/24VDC	ALM	512.45	149701	2
	DBZ	584.85	153513	2
2952 Magnetic Lock 1,650 lb. holding force Surface mount - double 12/24VDC	ALM	1,041.60	152042	2
	DBZ	1,180.80	153528	2
2953 Magnetic Lock 1,200 lb. holding force Surface mount - single 12/24VDC	ALM	484.65	149707	2
	DBZ	551.45	153533	2
2954 Magnetic Lock 1,200 lb. holding force Surface mount - double 12/24VDC	ALM	980.35	152043	2
	DBZ	1,125.15	153538	2

Options: Adjustable timer input (TIME) \$75.75 (2-679-0109)
 Door Position Sensor (DPS) \$47.60 (2-679-0110)*
 Magnetic Bond Sensor (MBS) \$71.40 (2-679-0111)*
 Anti Tamper Switch (ATS) \$58.05 (2-679-0112)

Note: Additional finishes available for 2951, 2952, 2953, 2954.
 Inquire with Hager Customer Service for pricing.
 * Must order two for use with the 2952 or 2954



2-679-0120 Top jamb kit 2951/2953	ALM	119.25	149709	4
2-679-0121 Top jamb kit 2951/2953	DBZ	217.25		4
2-679-0130 Top jamb kit 2952/2954	ALM	239.55	153861	4
2-679-0131 Top jamb kit 2952/2954	DBZ	435.60		4



2-679-0160 Glass door kit 2951/2953 *Order 2 ea. for double door	ALM	220.60	168468	8
2-679-0161 Glass door kit 2951/2953 *Order 2 ea. for double door	DBZ	318.65		8



2-679-0180 Universal Bracket for 2951/2953	ALM	78.05	149710	12
2-679-0181 Universal Bracket for 2951/2953	DBZ	114.75		12
2-679-0190 Universal Bracket for 2952/2954	ALM	156.00	161684	9
2-679-0191 Universal Bracket for 2952/2954	DBZ	229.50	167699	9



Electrified Products



Description	Finish	2021 List	Stock No.	Case Qty.
2-679-0200 Spacer Bracket for 2951/2953	ALM	110.35	153684	12



2-679-0201 Spacer Bracket for 2952/2954	ALM	137.05	161686	9
---	-----	--------	--------	---

2-679-0204 Armature mounting plate	-	73.55	167666	3
--	---	-------	--------	---

2-679-0205 Armature mounting platem w/sensor		122.60	-	3
--	--	--------	---	---

Note: Additional finishes available on many of the 2950 magnetic lock series accessories. Inquire with Hager Customer Service for pricing.



2-679-0210 Coordinator mounting bracket for 2951/2953	ALM	147.10	160581	12
---	-----	--------	--------	----

2-679-0220 Coordinator mounting bracket for 2952/2954	ALM	269.65	166426	6
---	-----	--------	--------	---



2-679-0281 Filler bar - 1/8" x 1-1/4" for 2951/2953	ALM	40.15	149711	12
---	-----	-------	--------	----

2-679-0283 Filler bar - 1/8" x 1-1/4" for 2951/2953	DBZ	76.90	149712	12
---	-----	-------	--------	----

2-679-0291 Filler bar - 1/4" x 1-1/4" for 2951/2953	ALM	41.30	149713	12
---	-----	-------	--------	----

2-679-0293 Filler bar - 1/4" x 1-1/4" for 2951/2953	DBZ	78.05	149715	12
---	-----	-------	--------	----

2-679-0311 Filler bar - 1/2" x 1-1/4" for 2951/2953	ALM	45.70	149716	12
---	-----	-------	--------	----

2-679-0313 Filler bar - 1/2" x 1-1/4" for 2951/2953	DBZ	82.50	149738	12
---	-----	-------	--------	----

2-679-0321 Filler bar - 5/8" x 1-1/4" for 2951/2953	ALM	49.05	149717	12
---	-----	-------	--------	----

2-679-0323 Filler bar - 5/8" x 1-1/4" for 2951/2953	DBZ	85.80	149739	12
---	-----	-------	--------	----

2-679-0381 Filler bar - 1/8" x 1-1/4" for 2952/2954	ALM	45.70	149718	12
---	-----	-------	--------	----

2-679-0383 Filler bar - 1/8" x 1-1/4" for 2952/2954	DBZ	82.50	149740	12
---	-----	-------	--------	----

2-679-0391 Filler bar - 1/4" x 1-1/4" for 2952/2954	ALM	49.05	149719	12
---	-----	-------	--------	----

2-679-0393 Filler bar - 1/4" x 1-1/4" for 2952/2954	DBZ	85.80	149741	12
---	-----	-------	--------	----

2-679-0411 Filler bar - 1/2" x 1-1/4" for 2952/2954	ALM	53.55	149720	12
---	-----	-------	--------	----

2-679-0413 Filler bar - 1/2" x 1-1/4" for 2952/2954	DBZ	90.30	149742	12
---	-----	-------	--------	----

2-679-0421 Filler bar - 5/8" x 1-1/4" for 2952/2954	ALM	55.75	149721	12
---	-----	-------	--------	----





Description	Finish	2021 List	Stock No.	Case Qty.
2-679-0423 Filler bar - 5/8" x 1-1/4" for 2952/2954	DBZ	92.50	149743	12
2-679-0491 Angle Bracket - 1-1/2" x 1-1/2" for 2951/2953	ALM	55.75	149734	12
2-679-0493 Angle Bracket - 1-1/2" x 1-1/2" for 2951/2953	DBZ	90.30	149744	12
2-679-0501 Angle Bracket - 2" x 1-1/2" for 2951/2953	ALM	55.75	149735	12
2-679-0503 Angle Bracket - 2" x 1-1/2" for 2951/2953	DBZ	92.50	149745	12
2-679-0571 Angle Bracket - 1-1/2" x 1-1/2" for 2952/2954	ALM	71.35	149736	12
2-679-0573 Angle Bracket - 1-1/2" x 1-1/2" for 2952/2954	DBZ	108.10	149746	12
2-679-0581 Angle Bracket - 2" x 1-1/2" for 2952/2954	ALM	75.80	149737	12
2-679-0583 Angle Bracket - 2" x 1-1/2" for 2952/2954	DBZ	112.55	149747	12
Note: Additional finishes available on many of the 2950 magnetic lock series accessories. Inquire with Hager Customer Service for pricing				
2961 Magnetic Shear Lock 2,000 lb. holding force 1-5/8" depth, integrated electronics	US32D	880.05	151837	6
2965 Magnetic Shear Lock 2,700 lb. holding force 1-5/8" depth, integrated electronics ITC, FTC, HTC Same Price	US32D	952.45	151838	6
Options: ITC for standard mounting armature kit for aluminum and hollow metal doors with 7/8" to 1-1/8" deep top channels, wood doors, and factory prepared hollow metal flush edge doors. FTC for mounting for field prepared horizontal mounting in hollow metal doors with flush edge. HTC for mounting 1-15/16" deep Herculite channels. Herculite top rail armature adjustment bracket for leading edge adjustments (HTR) \$405.55 list price adder Magnetic bond sensor (MBS) \$130.85 list price adder Door Position sensor (DPS) \$59.50 list price adder				
2-679-0600 Wood Door reinforcement box for 2961	-	49.05	158750	6
2-679-0601 Wood Door reinforcement box for 2965		49.05		6
2958 Delayed Egress Magnetic Lock 1,650 lb. holding force Surface mount - single 12/24 VDC	ALM DBZ	1,347.95 1,420.35	149748 176098	6
2958 T Tandem Delayed Egress Magnetic Lock 1,650 lb. holding force Surface mount - double 12/24 VDC	ALM DBZ	2,266.95 2,344.90	159818	6



Electrified Products

Description	Finish	2021 List	Stock No.	Case Qty.
<p>Operation (Must Specify): NA - IBC, IFC, NFPA101, NFPA1-UFC, UBC, SBC Compliant ND - IBC, IFC, California Building Code OSHPD, NFPA 101, NFPA1-UFC, UBC, SBC Compliant BD - BOCA National Building Code CH - City of Chicago Building Code</p> <p>Reset Control: Built in key switch - 1-30 second timed bypass, sustained bypass and alarm reset (std) (Not available with BOCA and Chicago operation) Built in reset push switch. Available with NFPA (NA) only Less key or push switch (No price reduction)</p> <p>Options: Door Position Status (DPS) \$44.60 list price adder Magnetic Bond Sensor (MBS) \$73.00 list price adder Anti-Tamper Switch (ATS) \$61.30 list price adder</p>				
<p>2972 Exit Switch MSD 2" Square button Momentary, SPDT 10 AMP contact</p>	US32D	78.05	149630	12
<p>2972T Exit Switch with Integrated Adjustable Timer 2" Square Button Adjustable 1-60 second timer Note: Not Code Compliant</p>	US32D	150.45	151710	6
<p>Options: Red LED \$22.30 list price adder Green LED \$22.30 list price adder 2 LED's \$27.85 list price adder</p>				
<p>2973 Code Compliant Exit Switch 2" Square Button Integrated fixed 30- second timer CSFM Listed, NFPA, IBC, IFC code compliance for Access Controlled Egress Doors LED illumination</p>	US32D	156.00	149631	6
<p>Options: Red LED \$21.65 list price adder Green LED \$21.65 list price adder 2 LED's \$27.05 list price adder</p>				
<p>2977 Exit Switch Piezoelectric Button Green & Red Illumination Adj. 1-35 sec. 12/24VDC Timer</p>	US32D	156.00	149634	12
<p>2978 Touchless Exit Switch Infrared sensor Illuminated status indication</p>	US32D	91.95	149636	12
<p>4801 Pressure Sense Bar Pressure sense technology; Tri-failsafe 12/24 VDC voltage sense input includes 10 ft. cable and connector; armored power transfer loop 36" Standard, Optional 42" & 48" available</p>	ALM BLK	404.40 404.40	156360 167722	6



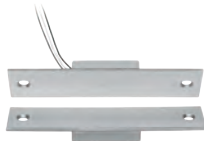

Description	Finish	2021 List	Stock No.	Case Qty.
2-679-0611 PIR Egress Sensor	White	267.40	149632	12
2-679-0612 PIR Egress Sensor	Black	267.40	62176	12
2-679-0708 Under Desk Push Switch	White	115.00	176289	1
2-679-0620 Concealed Mortise Power Transfer Loop	-	73.55	149750	12
2-679-0621 Heavy Duty Power Transfer 2-Wire	ALM	440.05	152079	6
2-679-0622 Heavy Duty Power Transfer 2-Wire	DBZ	440.05	160604	6
2-679-0623 Heavy Duty Power Transfer 10-Wire	ALM	440.05	149751	6
2-679-0624 Heavy Duty Power Transfer 10-Wire	DBZ	440.05	154018	6
2-679-0625 Concealed Magnetic Contact	ALM	121.70	152890	12
2-679-0626 Magnetic Switch	-	39.05	182672	1
2-679-0640 Single gang back box	-	14.80	149752	1
2-679-0641 3-gang interior mount box	-	110.35	166911	1
2-679-0642 Shroud for surface mount box outdoor use	-	70.05	166912	1
2-679-0650 Emergency Door Release Blue break glass station	-	225.10	149754	6
2-659-0368 Restroom Kit Includes relay, DPS, push to lock and indicator	-	555.00	34130	6
2-659-0372 Emergency Kit Includes light, button and sign	-	218.50	149754	6



8400 Series - Low Energy Power Operator



Description	Mount	Finish	2021 List	Stock No.	Box Qty.
8418 Single Operator	Push	ALM	4,642.90	162136	1
1 unit, 1 controller, single cover, handed		DBZ	4,642.60	162141	
Standard Sizes - 36"	Pull	ALM	4,674.25	162138	
42", 44" and 48" - add \$263.00 to list price		DBZ	4,674.25	162143	
Specify Push or Pull side of door					
8419 Simultaneous Pair	Push	ALM	8,333.00	162145	1
2 units, 1 controller, double cover, non-handed		DBZ	8,333.00	162147	
Standard Sizes - 60" and 72"	Pull	ALM	8,435.70	162146	
84", 88", 92" and 96" - add \$263.00 to list price		DBZ	8,435.70	162148	
Specify Push or Pull side of door					
8420 Independent Pair	Push	ALM	9,107.35	162149	1
2 units, 2 controllers, double cover, non-handed		DBZ	9,107.35	162151	
Standard Sizes - 60" and 72"	Pull	ALM	9,213.30	162150	
84", 88", 92" and 96" - add \$263.00 to list price		DBZ	9,213.20	162152	
Specify Push or Pull side of door					
8421 Double Egress Simultaneous Pair	Push/Pull	ALM	8,851.85	162153	1
2 units, 1 controller, double cover, non-handed		DBZ	8,851.85	162154	
Standard Sizes - 60" and 72"					
84", 88", 92" and 96" - add \$263.00 to list price					
8422 Double Egress Independent Pair	Push/Pull	ALM	9,674.00	162155	1
2 units, 2 controllers, double cover, non-handed		DBZ	9,674.00	162156	
Standard Sizes - 60" and 72"					
84", 88", 92" and 96" - add \$263.00 to list price					
8423 Single Operator with Mechanical Closer	Push	ALM	6,272.70		1
1 unit, 1 controller, 1-5100 Series Door Closer,		DBZ	6,272.70		
double cover, handed	Pull	ALM	6,272.70		
Standard Sizes - 60" and 72"		DBZ	6,272.70		
84", 88", 92" and 96" - add \$263.00 to list price					
Specify Push or Pull side of door					
*Note: Non-standard door widths in quantities under 50 units: please contact Technical Support for list adder.					
*Note: Curtain wall operators are available. Please contact Technical Support					

8400 Series - Low Energy Power Operator

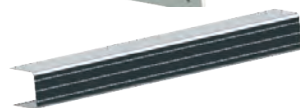

Description	Finish	2021 List	Stock No.	Case Qty.	Box Qty.
2-659-0151 Pull Side Track Arm with 20mm Spindle	ALM	448.85	162512	-	1
2-659-0152 Pull Side Track Arm with 20mm Spindle	DBZ	546.20	162513	-	
2-659-0153 Push Side Standard Arm with 35mm Spindle	ALM	448.85	162515	-	1
2-659-0154 Push Side Standard Arm with 35mm Spindle	DBZ	546.20	162516	-	
2-659-0220 Push Side Standard Arm with 50mm Spindle For use with double egress assemblies	ALM	448.85	162561	-	1
2-659-0221 Push Side Standard Arm with 50mm Spindle For use with double egress assemblies	DBZ	546.20	162562	-	
2-659-0222 Double Egress Arm Assembly Track arm with 20mm Spindle	ALM	811.15	162563	-	1
2-659-0223 Double Egress Arm Assembly Track arm with 20mm Spindle	DBZ	919.30	162564	-	
2-659-0224 20mm Replacement Spindle For use with double egress and track arm assembly	ALM	155.25	162565	-	1
2-659-0225 20mm Replacement Spindle For use with double egress and track arm assembly	DBZ	189.30	162566	-	
2-659-0226 35mm Replacement Spindle For use with standard single and standard pair applications	ALM	155.25	162567	-	1
2-659-0227 35mm Replacement Spindle For use with standard single and standard pair applications	DBZ	189.30	162568	-	
2-659-0228 50mm Replacement Spindle	ALM	155.25	162570	-	1
2-659-0229 50mm Replacement Spindle For use with push side standard arm - double egress only	DBZ	189.30	162573	-	
2-659-0230 Narrow Top Rail Drop Plate	ALM	137.40	162693	-	1
2-659-0231 Narrow Top Rail Drop Plate	DBZ	137.40	162694	-	
2-659-0232 Cover for Single Operator - 36"	ALM	259.60	162574	-	1
2-659-0233 Cover for Single Operator - 36"	DBZ	259.60	162661	-	



8400 Series - Low Energy Power Operator

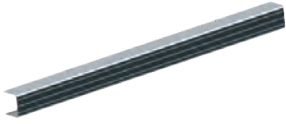

Description	Finish	2021 List	Stock No.	Case Qty.	Box Qty.
2-659-0234 Cover for Dual Operators - 72"	ALM	454.25	162663	-	1
2-659-0235 Cover for Dual Operators - 72"	DBZ	454.25	162692	-	-
Note: Additional sizes available. Inquire with Hager customer service for pricing.					
2-659-0236 Power Supply On-Board 115 VAC 60Hz 24 VDC 500mA		849.00	162696	-	1
2-659-0237 Relay Board 24VDC 40mA 5 amp/ 220 VAC or 28VDC DPDT contacts		33.05	162697	-	1



8300 Series - Low Energy Power Operator



Description	Mount	Finish	2021 List	Stock No.	Box Qty.
8318 Single Operator	Push	ALM	3,250.00	75963	1
1 unit, single cover, non-handed		DBZ	3,625.00	75960	1
Standard Sizes - 36"	Pull	ALM	3,250.00	75956	1
42", 44" and 48"		DBZ	3,625.00	75937	1
Specify Push or Pull side of door					
8319 Simultaneous Pair	Push	ALM	6,500.00	75652	1
2 units, double cover, non-handed		DBZ	7,670.00	75653	1
Standard Sizes - 72"	Pull	ALM	6,500.00	75650	1
84", 88", and 96"		DBZ	7,670.00	75644	1
Specify Push or Pull side of door					
8321 Double Egress Simultaneous Pair	Push/Pull	ALM	7,205.00	75584	1
2 units, double cover, non-handed					
Standard Sizes - 72"					
84", 88", 96"					

For non-standard sizes, add \$246.90 to single operator list price. For doubles, add \$370.40 to the list price.



8300 Series - Low Energy Power Operator

Description	Finish	2021 List	Stock No.	Case Qty.	Box Qty.
2-679-0901 8300 - 20mm Replacement Spindle		113.65	75504	-	1
2-679-0902 8300 - 35mm Replacement Spindle		113.65	75500	-	1
2-679-0903 8300 - 50mm Replacement Spindle		113.65	75501	-	1
2-679-0904 8300 - 80mm Replacement Spindle		136.40	75502	-	1
2-679-0896 8300 - Standard Arm w/ 35mm Spindle (Push)	ALM	340.90	75498	-	1
2-679-0897 8300 - Standard Arm w/ 35mm Spindle (Push)	BLK	340.90	75494	-	1
2-679-0898 8300 - Track Arm w/ 20mm Spindle (Pull)	ALM	431.90	75495	-	1
2-679-0899 8300 - Track Arm w/ 20mm Spindle (Pull)	BLK	431.90	75485	-	1
2-679-0900 8300 - Dbl Egress Arm w/ 20mm Spindle (Pull)	ALM	136.40	75482	-	1
2-679-0905 8300 - Standard Arm Extension	ALM	227.25	75478	-	1
2-679-0906 8300 - Standard Arm Extension	BLK	909.15	75472	-	1
2-679-0907 8300 - KP EVO Programming Device		1,181.90	75470	-	1

Electrified Products - Low Energy Power Operator Controls



Description	Finish	2021 List	Stock No.	Case Qty.	Box Qty.
2-659-0303 6" Round with Text & Logo	US32D/Blue	212.20	185055	12	1
2-659-0304 6" Round with Logo Only	US32D/Blue	212.20	185058	12	1
2-659-0305 4-3/4" Square with Text & Logo	US32D/Blue	212.20	185056	12	1
2-659-0306 4-3/4" Square with Logo Only	US32D/Blue	212.20	185059	12	1
2-659-0307 4-3/4" Square with Logo Only	US32D/Blue	212.20	186793	12	1
2-659-0308 4-3/4" Square with Text Only	US32D/Blue	212.20	186794	12	1
2-659-0161 6" Round Actuator Push To Open and Handicap Symbol	US32D/Blue	127.35	162698	20	1
2-659-0162 6" Round Actuator Handicap Symbol	US32D/Blue	127.35	162699	20	1
2-569-0357 4.5" Square Actuator Push to Open text and Accessibility Logo	US32D/Blue	100.50	068110	20	1
2-659-0358 6" Round Actuator Push to Open text and Accessibility Logo	US32D/Blue	100.50	068104	20	1
2-659-0163 Surface Mount Box For 6" Round Actuator	Black	42.45	162700	20	1



Electrified Products - Low Energy Power Operator Controls



2-659-0164
Weather Ring
For 6" Round Actuator

Black 8.50 162701 10 1



2-659-0162
6" Round Actuator
Handicap Symbol

US32D/Blue 127.35 162699 20 1



2-659-0165
4.5" Round Actuator
Push To Open and Handicap Symbol

US32D/Blue 110.40 162703 20 1



2-659-0166
4.5" Round Actuator
Handicap Symbol

US32D/Blue 110.40 162704 20 1



2-659-0167
Surface Mount Box
For 4.5" Round Actuator

Black 34.00 162705 20 1



2-659-0168
Weather Ring
For 4.5" Round Actuator

Black 8.50 162706 10 1



2-659-0241
Universal Back Plate
For use when mounting 4.5" round or 4.5" square actuator to bollard post

US32D 27.65 162743 10 1



2-659-0169
6" Square Actuator
Push To Open and Handicap Symbol

US32D/Blue 127.35 162707 20 1



2-659-0170
6" Square Actuator
Handicap Symbol

US32D/Blue 127.35 162708 20 1



2-659-0171
Surface Mount Box
For 6" Square Actuator

Black 34.00 162709 20 1



2-659-0172
4.5" Square Actuator
Push To Open and Handicap Symbol

US32D/Blue 104.00 162710 20 1

Electrified Products - Low Energy Power Operator Controls



Description	Finish	2021 List	Stock No.	Case Qty.	Box Qty.
2-659-0173 4.5" Square Actuator Handicap Symbol	US32D/Blue	104.00	162711	20	1
2-659-0174 Surface Mount Box For 4.5" Square Actuator	Black	34.00	162712	45	1
2-659-0175 1.5" x 4.75" Jamb Actuator Push To Open and Handicap Symbol	US32D/Blue	100.80	162713	20	1
2-659-0176 1.5" x 4.75" Jamb Actuator Handicap Symbol	US32D/Blue	100.80	162714	20	1
2-659-0177 Surface Mount Box For 1.5" x 4.75" Jamb Actuator	Black	21.25	162715	20	1
2-659-0178 36" Low Profile Actuator Push To Open and Handicap Symbol Wireless Includes 433 MHz wireless transmitter Exceeds California Building Code, Section 1117B.6	US32D/Blue	742.65	162716	2	1
2-659-0179 36" Low Profile Actuator Push To Open and Handicap Symbol Hard Wired Exceeds California Building Code, Section 1117B.6	US32D/Blue	684.30	162717	2	1
2-659-0242 4.75" Vestibule Actuator Push To Open and Handicap Symbol	US32D/Blue	254.65	162741	20	1
2-659-0243 Surface Mount Box For 4.75" Vestibule Actuator	Black	79.60	162742	42	1
2-659-0180 Bollard Post For use with 4.5" round and 4.5" square push plates	Black	530.45	162720	1	1



Electrified Products - Low Energy Power Operator Controls



Description	Finish	2021 List	Stock No.	Case Qty.	Box Qty.
2-659-0181 Bollard Post For use with 4.5" round and 4.5" square push plates	Bronze	530.45	162724	1	1
2-659-0182 Bollard Post For use with 4.5" round and 4.5" square push plates	Silver	530.45	162725	1	1
2-659-0183 433 MHz Receiver Digital, Radio Controlled	-	122.05	162726	20	1
2-659-0184 3-Volt Transmitter Wireless Hardwired to actuator	Black	116.70	162727	20	1
2-659-0185 9-Volt Transmitter Wireless	Black	116.70	162728	20	1
2-659-0186 Wireless Transmitter One Button	Black	116.70	162729	20	1
2-659-0240 Programmable Relay and Door Sequencer For door timing and advanced relay sequencing	-	179.45	082867	20	1
*Note: Actuators come standard hard-wired. Must order receiver and transmitter separately for wireless applications.					
2-659-0332 Bodyguard Sensor Overhead Presence Sensor	Black	\$541.05	94685	24	1
2-659-0333 Bodyguard Programming Remote		\$61.15	94645	1	1
2-659-0334 Bodyguard Mounting Kit	Black	\$56.00	94641	20	1
2-659-0335 Superscan I Safety Sensor Single Mount Unit	Black	\$391.80	94626	6	1
2-659-0336 Superscan II Safety Sensor Single Mount Unit with Master and Slave Modules	Black	\$671.65	94623	6	1





H **HAGER**[®]
COMPANIES

TABLE OF CONTENTS

	A			F
Additions.....		4	Fasteners.....	4
Architectural Finish Symbols		3	Filler Plates	
Armor Plates.....		6-8	Filler Plate, Door Face.....	90
	C		Filler Plate, Flush Bolt Strike.....	90
Chain Door Check.....		84	Filler Plate, Door Edge.....	90
Coat Hooks.....		101, 112-114	Filler Plate, Template Hinge Shim.....	91
Corner Guard.....		68	Filler Plate, Frame Strike.....	91
Custom Pulls			Filler Plate, Latch Adapter.....	91
18 Degree Pull.....		127-128	Filler Plate, Flush Bolt.....	91
90 Degree Pull.....		110	Filler Plate, Frame Hinge.....	91
Acorn Tip Pull.....		115-116	Flush Bolts	
Colonial Pull.....		111	Automatic Flush Bolts.....	80-81
C-Shaped Pulls.....		104-109	Constant Latching Flush Bolt	81
Curved Shape Pulls.....		109, 116, 124-126	Dust Proof Strike.....	79
Offset Mount, Vertical Pull.....		102-103	Automatic Flush Bolt with Fire Bolt.....	82
Offset Pulls.....		111-112, 127	Manual Flush Bolts.....	80
Segment Shape Pulls.....		120-123	Residential Flush Bolts.....	132-133
Square Tip Pull.....		114	Slide Flush Bolt.....	79
S-Shaped Pulls.....		100-111		
Steeple Tip Pull.....		115		
Straight Mount, Vertical Pulls.....		103-104, 123		
Crating.....		3		
	D			H
Door Coordinators			Hand Rail Bracket.....	84, 136
Carry Bar.....		82		
Coordinator with Filler Bar.....		83		
Filler Bars.....		83		
Gravity Coordinator.....		83		
Mounting Brackets.....		83		
Door Edgings				K
Mortise Type.....		61-63	Kick Plates.....	6-8
Overlap Type.....		64-65		
Surface Type.....		66-68		
Door Guard.....		77, 132		L
Door Knocker Viewer.....		86, 90	Latches	
Door Protection Plates.....		6-8	Hospital Latch, 2-3/4" Backset.....	85
Door Latch (Privacy).....		78	Hospital Latch, 5" Backset.....	85
Door Silencers			Hospital Latch, Lead Lined.....	85
Metal Door.....		85	Latch Conversion Kit.....	85
Wood Door.....		85	Pocket Door Latch.....	89
Door Viewers.....		135	Privacy Pocket Door Latch.....	89
			Latch Protectors.....	92



Trim & Auxiliary

M

Miscellaneous Hardware

Closet Knobs.....	130
Closet Rod, Sockets.....	136
Concealed Edge Pull.....	24
Finger Pulls.....	129
Magnetic Catch.....	134
Pocket Door Edge Pulls.....	130,131
Mounting Options.....	5

P

Pulls

Anti Vandal Trim.....	85
Back-to-Back Offset Pulls.....	23-24
Back-to-Back Straight Pulls.....	18-20
Cast Pulls.....	22, 35
Flush Cup Pulls.....	20-21, 25-26
Half Round.....	9
Offset Pulls.....	16-18, 25, 111
Oval.....	15
Rectangular.....	10
Round.....	11-13, 16-20
Straight Pulls.....	9-16
Wire Drawer Pulls.....	84

Pull Plates

Cylinder Pull.....	45
Pull Plate w/ Lip.....	45
Square Corner.....	29-37

Push Bars

Back-to-Back.....	49
Bent.....	46-48
Flat.....	46-47
Round.....	47-48

Push Plates

Beveled - Square Corner.....	40-42
Half Circle.....	45
Plastic Laminate.....	7, 40-41
Radius Corner.....	37-40, 42
Round Bevel Top and Bottom.....	43
Rounded Corner.....	39-40
Square Corner.....	27-28

Push/Pull Sets

Flat Bar.....	61
Round Bar.....	46-56
Security Push/Pull Plate.....	45

R

Recommended Application.....	3
Recommended Maintenance.....	3
Residential Trim.....	84, 87, 129-134

Roller Latch/Catches

Adjustable Ball Catch.....	86
Drive-In Ball Catch.....	134
Roller Latch.....	86
Roller Latch with Stop.....	86
Roller Latch w/ ASA Strike.....	128
Roller Latch w/ Full Lip Strike.....	128
Roller Latch w/ Tee Strike.....	86
Three-Way Ball Catch.....	87

S

Signage

ADA Tactile, Plastic.....	97-100
International Symbols, Plastic.....	96
Men/Women, Plastic.....	95
Numbers, Plastic.....	94
Push/Pull, Plastic.....	93
Restroom/Restrooms, Plastic.....	95

Stops and Holders

Roller Bumper.....	77
Door Holder, Kickdown.....	76, 131
Floor Stops.....	70-76, 87-89, 131
Heavy Duty Floor Stop.....	75
Stops With Holder.....	72-74, 87-89
Wall Stops.....	68-69, 72-74, 87-88, 131
Hinge Pin Door Bumper.....	132, 136
Surface Bolts.....	78



CRATING CHARGES

When ordered separately, orders of less than 5 armor plates (plates over 22 inches high and wide) are subject to a \$16.40 net crating charge.

ARCHITECTURAL FINISH SYMBOLS

Unless specifically noted, finishes are priced as listed by each item on the following pages.

US & HAGER	DESCRIPTION	BASE MATERIAL	PRICING INSTRUCTIONS	BHMA SYMBOL
2C	Zinc Plated Steel	Steel	As Listed	603
3	Bright Brass	Brass	As Listed	605
4	Satin Brass	Brass	As Listed	606
5	Satin Brass, Oxidized	Brass Brass/Bronze	25% Above US10B	609
9	Bright Bronze	Brass Brass/Bronze	25% Above US10	611
10	Satin Bronze	Brass Brass/Bronze	As Listed	612
10B	Antique Bronze, Oiled	Brass Brass/Bronze	As Listed	613
10R	Matte Lacquer Antique Bronze	Brass Brass/Bronze	As Listed	-
15	Satin Nickel	Brass Brass/Bronze	Price Same as US26D	619
15A	Satin Nickel Oxidized	Brass Brass/Bronze	As Listed	620
19	Flat Black Coated	Any	As Listed ¹	622
26	Bright Chromium Plated	Brass Brass/Bronze	As Listed	625
26D	Satin Chromium Plated	Brass Brass/Bronze	As Listed	626
28	Satin Anodized Aluminum	Aluminum	As Listed	628
32	Stainless Steel Metal, Bright	300 Series	As Listed	629
32D	Stainless Steel Metal, Satin	300 Series	As Listed	630
DBZ	Dark Bronze Painted	Any	As Listed	695
PC	Clear Plastic	-	As Listed	-
PK	Plastic Laminate - Black	-	As Listed	-
CO	Plastic Laminate - Chocolate	-	As Listed	-
PG	Plastic Laminate - Grey	-	As Listed	-
S1	Sprayed Aluminum	Cast Iron	As Listed	-
S2	Sprayed Brass	Cast Iron	As Listed	-
S3	Sprayed Bronze	Cast Iron	As Listed	-

1. Same as DBZ unless otherwise listed.

NOTE: For any finish not listed in this Price Book, or explained above, price and availability on request.

RECOMMENDED SPECIAL INSTRUCTIONS:

Application: All accessory item installation should be made following the application of paint or other finishes. Under no circumstances should accessory items be installed prior to painting. Paint or other finish material must be dry before applying accessory items to door. Hager recommends that a 72 hour drying time be allowed prior to application of accessory items under normal atmospheric conditions.

Maintenance: For cleaning, use only a soft damp cloth. Do not use any chemicals, abrasive cleaners, waxes, or brass cleaners on items with a lacquer coating or on plastic plates.



Trim & Auxiliary

ADDITIONS WHERE NOT LISTED

Door Edgings

For quantities less than 20 of one type of door edging, add 30% to list price.

Pull, Push Plate, Pull Plate, or Kick Plate Options

Add to the list price of each unit:

Antimicrobial Powder Coat Protection (32D only)

To order use MV3 as suffix - \$15.25 list price each

Flush Back Mounting on Pull Plates

\$11.50 list each plate.

Cutouts - Standard Locations (Not available on Kick Plates)

Wrought (.050) thickness -

-Cut for 1-1/4" (CFC) Standard Cylinder, add \$15.70 each.

-Cut for 2-1/8" (CFC) Cylinder or Turn Piece, add \$15.70 each.

Other thickness plates -

-Cut for 1-1/4" (CFC) Standard Cylinder, add \$18.75 each.

-Cut for 2-1/8" (CFC) Cylinder or Turn Piece, add \$18.75 each.

Cutouts - Non-Standard Locations

Priced on application.

Engraving

For engraving standard "PUSH" or "PULL", "Men" or "Women" for stainless steel, add \$46.45 each, \$92.95 set.

For engraving standard "PUSH" or "PULL", "Men" or "Women" for all other materials, add \$31.55 each, \$63.15 set.

Tactile Warning

Available on limited items. Add \$43.10 to list.

Pull Plates - Non-Standard

To price pull plates not listed in price book, add list price of pull desired to the list price of the plate desired, plus \$5.05 list for assembly charge (and any other options required). Add \$5.00 list for punching two holes in push plates.

Accessibility Option

For Hager Special Accessibility Clearance - (2-1/2"), prefix "H". Add \$6.65 List for single pull and \$13.30 List for double pull.

FASTENERS

Illustrated below are various types of fasteners that can be furnished by Hager Companies. Please specify type of fastening desired. All types of fastening cannot be used with all items of hardware. If specified method is not possible, we reserve the right to furnish whatever type we feel is best suited for the installation. When used with tempered glass doors, specify thickness of glass and hole diameter.



Hex bolt and machine screws
(various sizes)



Lead anchor
(used with floor stops in masonry applications)



Plastic anchor and full threaded screw
(used in drywall or masonry applications)



Lag screw and shield

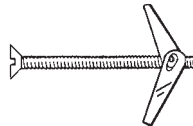

Toggle bolt
(ideal for drywall applications)

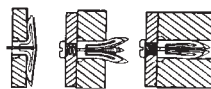

Plastic toggle anchor
(used with wall stops in drywall applications)



Thru-bolt and finish washer
(flat or oval head; size as required)



Spanner head machine screws
(various sizes furnished at extra charge)



Security torx head machine screws
(various sizes furnished at extra charge)

Note: Torx and Spanner screws are available for select items. Please call Customer Service for availability and price.

MOUNTINGS

Illustrated below are various types of mountings that can be furnished by Hager Companies. Please specify type of mounting desired. All types of mountings cannot be used with all items of hardware. If specified method is not possible, we reserve the right to furnish whatever type we feel is best suited for the installation. When used with tempered glass doors specify thickness of glass and hole diameter.

Mounting Accessory Charges:

For Concealed Cone mountings, add \$11.50 list for each required fitting (Type 3).

For Concealed Cone mountings, add \$11.50 list for each required fitting (Type 5).

For Spanner Collar mountings, add \$19.75 list for each required fitting (Type 7).

For Concealed Cone and Lug mountings, add \$29.15 list for each required fitting. (.125" plate only)

Temper Glass Door Installation:

Spanner Cap Mountings (Type 8) for tempered glass doors, add \$19.75 list for each spanner cap.

Note: Mounting back-to-back or spanner cap installation requires at least two fittings.

Stile Plates, add \$16.50 list each.

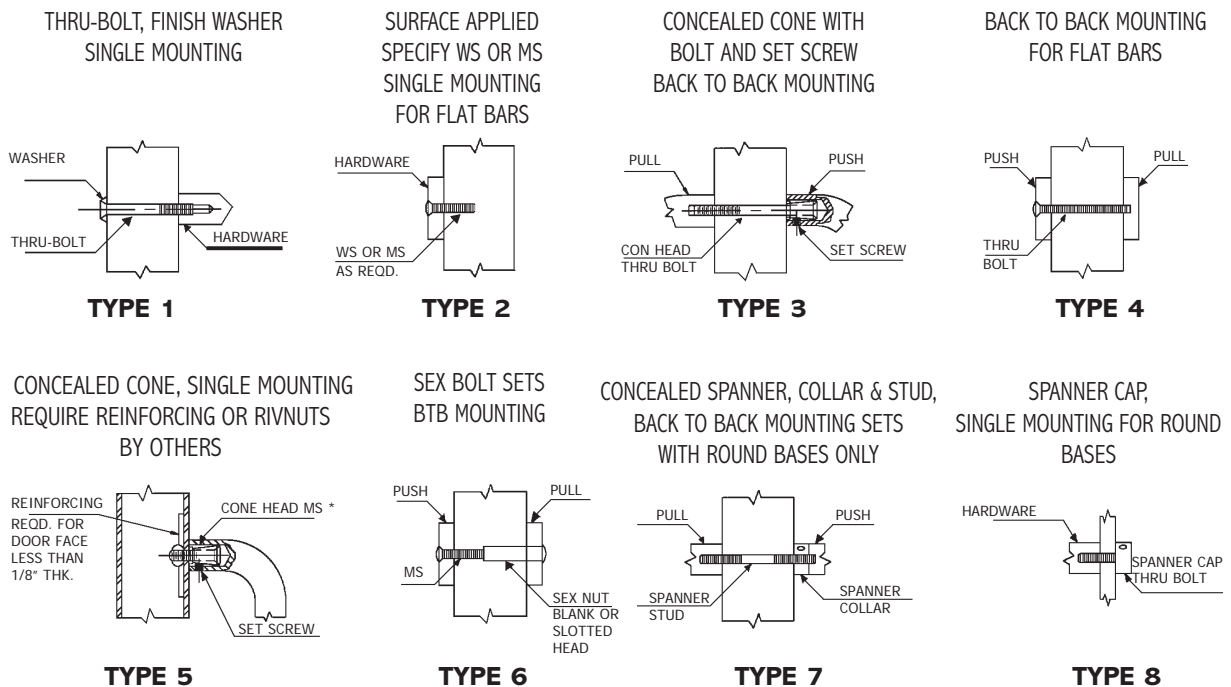

Lead Times

Stock items will typically ship in five working days or less from the order entry date. Made-to-order items will typically ship in 15 working days depending on seasonal volume and order complexity. Special orders including industrials, special machining, and large quantities may need to be scheduled. The anticipated ship date will be included with each order acknowledgement. Please contact Customer Service if product availability is in question.

Quick Ship

Products denoted with **red and bold** pricing are available to order through the Quick Ship program and ship within 24 hours. When ordering these products please visit www.hagerco.com and log in to MyHager to access the 'Quick Ship' portal. Due to the promptness of the fulfillment process, Quick Ship orders are non-cancellable.

Cancellation Notification

Cancellation for made-to-order items must be communicated within 48 hours of order placement.



Trim & Auxiliary

DOOR PLATE HUNDRED SQUARE INCH SIZE CHART													
H/W	24"	26"	28"	30"	32"	34"	36"	38"	40"	42"	44"	46"	48" MAX
4"	0.96	1.04	1.12	1.20	1.28	1.36	1.44	1.52	1.60	1.68	1.76	1.84	1.92
6"	1.44	1.56	1.68	1.80	1.92	2.04	2.16	2.28	2.40	2.52	2.64	2.76	2.88
8"	1.92	2.08	2.24	2.40	2.56	2.72	2.88	3.04	3.20	3.36	3.52	3.68	3.84
10"	2.40	2.60	2.80	3.00	3.20	3.40	3.60	3.80	4.00	4.20	4.40	4.60	4.80
12"	2.88	3.12	3.36	3.60	3.84	4.08	4.32	4.56	4.80	5.04	5.28	5.52	5.76
14"	3.36	3.64	3.92	4.20	4.48	4.76	5.04	5.32	5.60	5.88	6.16	6.44	6.72
16"	3.84	4.16	4.48	4.80	5.12	5.44	5.76	6.08	6.40	6.72	7.04	7.36	7.68
18"	4.32	4.68	5.04	5.40	5.76	6.12	6.48	6.84	7.20	7.56	7.92	8.28	8.64
20"	4.80	5.20	5.60	6.00	6.40	6.80	7.20	7.60	8.00	8.40	8.80	9.20	9.60
22"	5.28	5.72	6.16	6.60	7.04	7.48	7.92	8.36	8.80	9.24	9.68	10.12	10.56
24"	5.76	6.24	6.72	7.20	7.68	8.16	8.64	9.12	9.60	10.08	10.56	11.04	11.52
26"	6.24	6.76	7.28	7.80	8.32	8.84	9.36	9.88	10.40	10.92	11.44	11.96	12.48
28"	6.72	7.28	7.84	8.40	8.96	9.52	10.08	10.64	11.20	11.76	12.32	12.88	13.44
30"	7.20	7.80	8.40	9.00	9.60	10.20	10.80	11.40	12.00	12.60	13.20	13.80	14.40
32"	7.68	8.32	8.96	9.60	10.24	10.88	11.52	12.16	12.80	13.44	14.08	14.72	15.36
34"	8.16	8.84	9.52	10.20	10.88	11.56	12.24	12.92	13.60	14.28	14.96	15.64	16.32
36"	8.64	9.36	10.08	10.80	11.52	12.24	12.96	13.68	14.40	15.12	15.84	16.56	17.28
38"	9.12	9.88	10.64	11.40	12.16	12.92	13.68	14.44	15.20	15.96	16.72	17.48	18.24
40"	9.60	10.40	11.20	12.00	12.80	13.60	14.40	15.20	16.00	16.80	17.60	18.40	19.20
42"	10.08	10.92	11.76	12.60	13.44	14.28	15.12	15.96	16.80	17.64	18.48	19.32	20.16
44"	10.56	11.44	12.32	13.20	14.08	14.96	15.84	16.72	17.60	18.48	19.36	20.24	21.12
46"	11.04	11.96	12.88	13.80	14.72	15.64	16.56	17.48	18.40	19.32	20.24	21.16	22.08
48" MAX	11.52	12.48	13.44	14.40	15.36	16.32	17.28	18.24	19.20	20.16	21.12	22.08	23.04

To figure the list price of a door protection plate, find the hundred square inch size on the chart above. For odd or fractional sizes use the next higher price (i.e. 8" x 31-1/2" - price as 8" x 32" = 2.56 sq. inches). Multiply the square inch size by the list price (for example, 2.56 sq. inches x US\$31.10 = \$79.62 list).

- #6 x 5/8" Phillips Oval Head undercut, Stainless Steel Sheet Metal Screws for counter sunk plates and Truss Head Stainless Steel Screws for non-counter sunk plates, to match plated finish.
- When ordered separately, orders of less than 5 armor plates are subject to a \$16.40 net crating charge (plates over 22 inches high and wide).
- Four rounded corners are available for \$20.00 list.
- Kickplates specified with adhesive tape will be supplied without holes.
- Armor plates available with UL listing. See page 7.
- Cutouts for kick and armor plates priced on application.

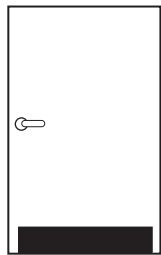

Mop Plate
Up to 8"h x 48"w

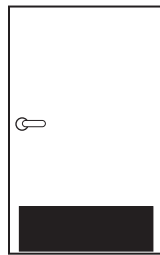

Kick Plate
6"-12"h x 48"w



Stretcher Plate
6"-12"h x 48"w

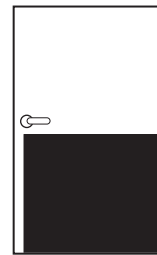

Armor Plate
Up to 48"h x 48"w

NFPA 80 STANDARD 6.4.5.3

- Factory installed protection plates shall be installed in accordance with the listing of the door.
- Field installed protection plate shall be labeled and installed in accordance with their listing.

Exception: Labeling is not required where the top of the protection plate is not more than 16" (406 mm) above the bottom of the door.





Description	Height	US28	US3, US4,	US10B	DBZ US19, US9	US32	US32D
190S	Under 8" high	11.40	32.75	47.80	38.21	22.85	10.25
Four beveled edges	8" to 24" high	9.55	32.00	46.90	37.55	22.20	9.20
.050 Gauge	Over 24" to 36" high	9.65	40.95	58.20	46.55	22.45	9.40
Metal Door Protection Plate	Over 36" to 48" high	10.50	49.40	70.60	56.45	22.45	9.40
Note: UL Listed for US32 and US32D only	8" x 34" (List Pricing)	-	-	-	-	-	24.95
	10" x 34" (List Pricing)	-	-	-	-	-	31.15



198S	Under 8" high	-	-	-	-	-	9.70
.038 Gauge	8" to 24" high	-	-	-	-	-	8.65
Metal Door Protection Plate	Over 24" to 36" high	-	-	-	-	-	8.90
	Over 36" to 48" high	-	-	-	-	-	8.90

Note: UL labeling not required when top of plate is less than 16" above the bottom of the door, per NFPA 80 - 2007.

Description	Height	BGA
199B	Under 8" high	11.40
Bright Gold Anodized	8" to 24" high	9.60
100 square inches	Over 24" to 36" high	9.65
.038 Gauge	Over 36" to 48" high	10.50
Metal Door Protection Plate		

Description	Height	Clear Plastic	Black	Brown	Grey
204S	Up to 48" high	9.37	-	-	-
Clear Plastic					
.125 Gauge					
214S	Up to 48" high	-	11.33	15.50	15.50
Plastic Laminate					
.125 Gauge					

Description	Height	US28	US3, US4, US10	US10B	DBZ US19, US9	US32	US32D
220S	Under 8" high	14.45	33.70	57.73	46.20	-	23.55
Four beveled edges	8" to 24" high	14.45	33.70	57.73	46.20	-	23.55
.062 Gauge	Over 24" to 36" high	15.45	36.45	63.05	50.40	-	23.55
Metal Door Protection Plate	Over 36" to 48" high	16.90	39.25	53.15	66.50	-	23.55

Note: Diamond plate is available in US26. Use US3/US4/US10 pricing.



Trim & Auxiliary



Description	Height	Black (Calcutta)	Brown (Chocolate)	Tan (Beige)
225S	Under 8" high	12.90	12.90	12.90
.060 Gauge	8" to 24" high	10.95	10.95	10.95
Kydex Door Protection Plate	Over 24" to 36" high	11.65	11.65	11.65
	Over 36" to 48" high	11.65	11.65	11.65

Note: UL labeling not required when top of plate is less than 16" above the bottom of the door, per NFPA 80 - 2007.

Option	Description	Price
CSK	Countersunk Holes	0.65 per 100 square inch price
SA	Self Adhesive Tape	0.65 per 100 square inch price
	Spanner Head Screws	0.65 each
	Torx Head Screws	0.65 each
	.125 Material	Price on Application
	Wrap Around Side & Bottom Return	Price on Application
	UL Label Stamp (No tape -voids UL Listing)	14.10





Description	Finish	2021 List	Stock No.	Box Qty.	Case Qty.
1E					
Pull- Half Round	US3	51.15	052830	1	12
Material: Brass, bronze, aluminum, stainless steel	US4	55.05	063599		
Base: 1/2" x 1"	US10	55.05	052831		
Projection: 2"	US10B	68.80	052832		
Clearance: 1-1/2"	DBZ	55.05	-		
CTC: 6"	US26	55.05	022786		
Door Thickness: 1-3/4" standard	US26D	55.05	052834		
Fasteners: 1/4"-20 x 2-1/4" FPHMS with washers	US28	29.35	052835		
Not suitable for BTB Mounting.	US32	53.50	074723		
	US32D	52.05	052836		



1G					
Pull- Half Round	US3	60.70	081562	1	12
Material: Brass, bronze, aluminum, stainless steel	US4	65.40	028588		
Base: 1/2" x 1"	US10	65.40	060015		
Projection: 2"	US10B	81.75	078323		
Clearance: 1-1/2"	DBZ	65.40	-		
CTC: 8"	US26	65.40	030588		
Door Thickness: 1-3/4" standard	US26D	65.40	066243		
Fasteners: 1/4"-20 x 2-1/4" FPHS with washers	US28	30.95	056587		
Not suitable for BTB Mounting.	US32	65.40	032021		
	US32D	65.20	058307		



1J					
Pull- Half Round	US3	71.15	073346	1	12
Material: Brass, bronze, aluminum, stainless steel	US4	77.50	026724		
Base: 1/2" x 1"	US10	77.50	067206		
Projection: 2"	US10B	96.90	062739		
Clearance: 1-1/2"	DBZ	77.50	-		
CTC: 10"	US26	77.50	013936		
Door Thickness: 1-3/4" standard	US26D	77.50	062738		
Fasteners: 1/4"-20 x 2-1/4" FPHMS with washers	US28	34.90	010948		
Not suitable for BTB Mounting.	US32	75.40	092494		
	US32D	72.20	072255		



1L					
Pull- Half Round	US3	81.60	022469	1	12
Material: Brass, bronze, aluminum, stainless steel	US4	89.80	059759		
Base: 1/2" x 1"	US10	89.80	019781		
Projection: 2"	US10B	112.25	048642		
Clearance: 1-1/2"	DBZ	89.80	-		
CTC: 12"	US26	89.80	-		
Door Thickness: 1-3/4" standard	US26D	89.80	085377		
Fasteners: 1/4"-20 x 2-1/4" FPHMS with washers	US28	43.15	067536		
Not suitable for BTB Mounting.	US32	87.95	060054		
	US32D	83.60	060014		

1. Items with the price in **bold and red** are Quick Ship items and ship in 24 hours.
Please use stock number when ordering. 2. U/M is each unless otherwise noted.



Trim & Auxiliary



Description	Finish	2021 List	Stock No.	Box Qty.	Case Qty.
2E					
Pull - Rectangular	US3	47.25	052812	1	12
Material: Brass, bronze, aluminum, stainless steel	US4	48.75	002326		
Base: 3/8" x 1-1/4"	US10	48.75	091536		
Projection: 2"	US10B	60.95	015641		
Clearance: 1-5/8"	DBZ	48.75	-		
CTC: 6"	US26	48.75	052815		
Door Thickness: 1-3/4" standard	US26D	48.75	052816		
Fasteners: 1/4"-20 x 2-1/4" FPHMS with washers	US28	24.85	052817		
Not suitable for BTB Mounting.	US32	53.25	-		
	US32D	47.80	052818		



2G					
Pull - Rectangular	US3	56.70	052819	1	12
Material: Brass, bronze, aluminum, stainless steel	US4	60.15	-		
Base: 3/8" x 1-1/4"	US10	60.15	052820		
Projection: 2"	US10B	75.20	052821		
Clearance: 1-5/8"	DBZ	60.15	-		
CTC: 8"	US26	60.15	120486		
Door Thickness: 1-3/4" standard	US26D	60.15	008573		
Fasteners: 1/4"-20 x 2-1/4" FPHMS with washers	US28	26.75	052824		
Not suitable for BTB Mounting.	US32	61.80	175262		
	US32D	58.35	052825		



2J					
Pull - Rectangular	US3	67.00	099284	1	12
Material: Brass, bronze, aluminum, stainless steel	US4	72.65	111300		
Base: 3/8" x 1-1/4"	US10	72.65	-		
Projection: 2"	US10B	92.75	083743		
Clearance: 1-5/8"	DBZ	74.20	-		
CTC: 10"	US26	74.20	-		
Door Thickness: 1-3/4" standard	US26D	74.20	067318		
Fasteners: 1/4"-20 x 2-1/4" FPHMS with washers	US28	29.95	072355		
Not suitable for BTB Mounting.	US32	41.40	-		
	US32D	71.40	063689		



2L					
Pull - Rectangular	US3	70.35	137565	1	12
Material: Brass, bronze, aluminum, stainless steel	US4	75.10	078244		
Base: 3/8" x 1-1/4"	US10	78.30	036307		
Projection: 2"	US10B	97.85	001482		
Clearance: 1-5/8"	DBZ	78.30	-		
CTC: 12"	US26	78.30	-		
Door Thickness: 1-3/4" standard	US26D	78.30	101506		
Fasteners: 1/4"-20 x 2-1/4" FPHMS with washers	US28	38.95	016671		
Note suitable for BTB Mounting.	US32	79.15	036632		
	US32D	76.05	068545		





Description	Finish	2021 List	Stock No.	Box Qty.	Case Qty.
3E					
Pull - Round	US3	53.55	052507	1	12
Material: Brass, bronze, aluminum, stainless steel	US4	53.55	082808		
Base: 3/4" diameter	US10	56.65	052508		
Projection: 2-1/4"	US10B	70.80	052510		
Clearance: 1-1/2"	DBZ	56.65	-		
CTC: 6"	US26	56.65	052826		
Door Thickness: 1-3/4" standard	US26D	56.65	052705		
Fasteners: 1/4"-20 x 2-1/4" FPHMS with washers	US28	22.65	052511		
	US32	55.60	003987		
	US32D	29.10	052512		



3G					
Pull - Round	US3	55.00	052706	1	12
Material: Brass, bronze, aluminum, stainless steel	US4	55.00	054828		
Base: 3/4" diameter	US10	58.20	052707		
Projection: 2-1/4"	US10B	72.75	052513		
Clearance: 1-1/2"	DBZ	58.20	-		
CTC: 8"	US26	58.20	052827		
Door Thickness: 1-3/4" standard	US26D	58.20	052708		
Fasteners: 1/4"-20 x 2-1/4" FPHMS with washers	US28	29.35	052709		
	US32	55.60	003987		
	US32D	30.90	052514		



3J					
Pull - Round	US3	56.40	058846	1	12
Material: Brass, bronze, aluminum, stainless steel	US4	56.40	017703		
Base: 3/4" diameter	US10	65.85	059315		
Projection: 2-1/4"	US10B	82.35	058929		
Clearance: 1-1/2"	DBZ	65.85	-		
CTC: 10"	US26	65.85	067231		
Door Thickness: 1-3/4" standard	US26D	65.85	060904		
Fasteners: 1/4"-20 x 2-1/4" FPHMS with washers	US28	38.10	064414		
	US32	57.40	009135		
	US32D	35.45	053788		



3L					
Pull - Round	US3	67.95	062658	1	12
Material: Brass, bronze, aluminum, stainless steel	US4	74.50	044307		
Base: 3/4" diameter	US10	80.20	084100		
Projection: 2-1/4"	US10B	100.25	067606		
Clearance: 1-1/2"	DBZ	80.20	-		
CTC: 12"	US26	80.20	088253		
Door Thickness: 1-3/4" standard	US26D	80.20	070804		
Fasteners: 1/4"-20 x 2-1/4" FPHMS with washers	US28	41.30	068010		
	US32	85.75	071641		
	US32D	61.00	056122		

1. Items with the price in **bold and red** are Quick Ship items and ship in 24 hours.
Please use stock number when ordering. 2. U/M is each unless otherwise noted.



Trim & Auxiliary



Description	Finish	2021 List	Stock No.	Box Qty.	Case Qty.
P4E Security Pull - Round Material: Stainless steel Base: 1" diameter Projection: 2-1/4" Clearance: 1-1/4" CTC: 6" Fasteners: 3/8" - 16 x 1-1/4" Nyloc hex head cap screws Concealed mounting in door, use on hollow metal doors only.	US32D	71.00	085014	1	12



T4E Security Pull - Round Material: Stainless steel Base: 1" diameter Projection: 2-1/4" Clearance: 1-1/4" CTC: 6" Door Thickness: 1-3/4" standard Fasteners: 1/4" - 20 x 2-1/4" FTXMS with washers Security Torx, Thru Bolt Mounting	US32D	74.15	085015	1	12
---	-------	-------	--------	---	----



4G Pull - Round Material: Brass, bronze, aluminum, stainless steel Base: 1" diameter Projection: 2-3/4" Clearance: 1-3/4" CTC: 8" Door Thickness: 1-3/4" standard Fasteners: 1/4"-20 x 2-1/4" FPHMS with washers	US3 US4 US10 US10B US26 US26D US28 US32 US32D	77.40 83.60 94.15 121.15 86.20 86.20 38.90 74.70 54.75	052710 071068 052711 052712 052828 052713 051945 056698 051946	1	12
---	---	--	--	---	----



4H Pull - Round Material: Brass, bronze, aluminum, stainless steel Base: 1" diameter Projection: 2-3/4" Clearance: 1-3/4" CTC: 9" Door Thickness: 1-3/4" standard Fasteners: 1/4"-20 x 2-1/4" FPHMS with washers	US3 US4 US10 US10B DBZ US26 US26D US28 US32 US32D	76.45 76.75 84.10 84.10 84.10 84.10 84.10 44.15 96.60 70.95	116804 - 154833 068290 - 139764 016412 099188 075526 037214	1	12
---	--	--	--	---	----





Description	Finish	2021 List	Stock No.	Box Qty.	Case Qty.
4J					
Pull - Round	US3	92.85	052714	1	12
Material: Brass, bronze, aluminum, stainless steel	US4	92.85	054807		
Base: 1" diameter	US10	94.15	052715		
Projection: 2-3/4"	US10B	121.15	052716		
Clearance: 1-3/4"	DBZ	96.90	-		
CTC: 10"	US26	94.85	052829		
Door Thickness: 1-3/4" standard	US26D	94.85	052515		
Fasteners: 1/4"-20 x 2-1/4" FPHMS with washers	US28	35.00	052717		
	US32	77.10	060648		
	US32D	60.85	052516		



4L					
Pull - Round	US3	86.95	056307	1	12
Material: Brass, bronze, aluminum, stainless steel	US4	86.95	062858		
Base: 1" diameter	US10	102.40	068316		
Projection: 2-3/4"	US10B	128.00	062875		
Clearance: 1-3/4"	DBZ	102.40	-		
CTC: 12"	US26	102.40	054951		
Door Thickness: 1-3/4" standard	US26D	102.40	072906		
Fasteners: 1/4"-20 x 2-1/4" FPHMS with washers	US28	51.75	059808		
	US32	112.75	069478		
	US32D	86.85	054672		



5D					
Pull - Round	US3	34.45	048492	1	12
Material: Brass, bronze, aluminum, stainless steel	US4	34.45	048493		
Base: 5/8" diameter	US10	37.25	048489		
Projection: 2-1/8"	US10B	46.55	048495		
Clearance: 1-1/2"	DBZ	37.25	-		
CTC: 5-1/2"	US26	37.25	007765		
Door Thickness: 1-3/4" standard	US26D	37.25	048496		
Fasteners: 1/4"-20 x 2-1/4" FPHMS with washers	US28	23.50	048491		
Not suitable for BTB Mounting.	US32	43.55	167480		
	US32D	32.40	048497		



5N					
Cast Pull					
Material: Brass, bronze, aluminum, stainless steel	US3	51.75	052289	1	12
Base: 5/8" x 1-3/16"	US4	55.60	052290		
Projection: 2"	US10	59.45	052291		
Clearance: 1-1/2"	US10B	74.30	052292		
Length: 6-1/8"	DBZ	59.45	-		
CTC: 5-1/2"	US26	59.45	052808		
Door Thickness: 1-3/4" standard	US26D	59.45	052701		
Fasteners: 1/4"-20 x 2-1/4" FPHMS with washers	US28	36.35	138885		
Not suitable for BTB Mounting.	US32D	65.20	052294		

1. Items with the price in **bold and red** are Quick Ship items and ship in 24 hours.
Please use stock number when ordering. 2. U/M is each unless otherwise noted.



Trim & Auxiliary



Description	Finish	2021 List	Stock No.	Box Qty.	Case Qty.
6N					
Cast Pull	US3	39.95	052295	1	12
Material: Brass, bronze, aluminum, stainless steel	US4	44.70	052296		
Base: 1" diameter	US10	55.30	052297		
Projection: 1-7/8"	US10B	69.15	052298		
Clearance: 1-3/8"	DBZ	55.30	-		
O/A Length: 6-1/2"	US26	55.30	028570		
CTC: 5-1/2"	US26D	55.30	052811		
Door Thickness: 1-3/4" standard	US28	28.85	052299		
Fasteners: 1/4"-20 x 2-1/4" FPHMS with washers	US32D	57.05	052300		
Not suitable for BTB Mounting.					



7N					
Cast Pull					
Material: Brass, bronze, aluminum					
Base: 2" diameter	US3	50.45	052301	1	12
Projection: 1-7/8"	US4	50.45	053309		
Clearance: 1-3/8"	US10	58.70	052302		
CTC: 5-1/2"	US10B	73.40	052806		
Door Thickness: 1-3/4" standard	DBZ	58.70	-		
Fasteners: 1/4"-20 x 2-1/4" FPHMS with washers	US26	58.70	052807		
Not suitable for BTB Mounting.	US26D	58.70	052304		
	US28	25.75	052303		



8N					
Material: Brass, bronze, aluminum					
Base: 2" diameter	US3	50.45	052305	1	12
Projection: 1-7/8"	US4	50.45	053310		
CTC: 5-1/2"	US10	53.55	052306		
Clearance: 1-3/8"	US10B	75.95	052700		
Fasteners: #8 x 1 OPHWS	DBZ	60.75	-		
Not suitable for BTB Mounting.	US26	53.55	052805		
	US26D	46.35	052308		
	US28	25.75	052307		



P8N					
Cast Pull	US4	71.00	081356	1	12
Material: Brass	US26D	71.00	084188		
Base: 1-1/2" x 1-5/8"					
Projection: 2-1/4"					
CTC: 7-3/4"					
Clearance: 1-9/16"					
O/A Length: 8-3/4"					
Fasteners: 3/8 - 16 x 3/4" FPHMS					
Not suitable for BTB Mounting.					





Description	Finish	2021 List	Stock No.	Box Qty.	Case Qty.
9E					
Pull - Oval	US3	40.50	078724	1	12
Material: Brass, bronze, stainless steel	US4	40.50	031734		
Base: 1/2" x 3/4"	US10	45.60	017647		
Projection: 2"	US10B	56.95	083301		
Clearance: 1-1/2"	DBZ	45.60	-		
CTC: 6"	US26	45.60	083270		
Door Thickness: 1-3/4" standard	US26D	45.60	082917		
Fasteners: 1/4"-20 x 2-1/4" FPHMS with washers	US32	47.25	109645		
Not suitable for BTB Mounting.	US32D	46.70	066230		



9G					
Pull - Oval	US3	45.30	073348	1	12
Material: Brass, bronze, stainless steel	US4	45.30	129264		
Base: 1/2" x 3/4"	US10	50.25	071399		
Projection: 2"	US10B	62.85	076145		
Clearance: 1-1/2"	DBZ	50.25	-		
CTC: 8"	US26	50.25	62005		
Door Thickness: 1-3/4" standard	US26D	50.25	073350		
Fasteners: 1/4"-20 x 2-1/4" FPHMS with washers	US32	33.85	089854		
Not suitable for BTB Mounting.	US32D	40.45	073862		



9J					
Pull - Oval	US3	50.30	032128	1	12
Material: Brass, bronze, stainless steel	US4	50.30	021300		
Base: 1/2" x 3/4"	US10	55.05	026721		
Projection: 2"	US10B	68.80	020045		
Clearance: 1-1/2"	DBZ	55.05	-		
CTC: 10"	US26	55.05	55471		
Door Thickness: 1-3/4" standard	US26D	55.05	068291		
Fasteners: 1/4"-20 x 2-1/4" FPHMS with washers	US32	56.15	112592		
Not suitable for BTB Mounting.	US32D	49.10	089049		







9L					
Pull - Oval	US3	55.05	001447	1	12
Material: Brass, bronze, stainless steel	US4	55.05	090944		
Base: 1/2" x 3/4"	US10	59.95	018507		
Projection: 2"	US10B	74.95	095056		
Clearance: 1-1/2"	DBZ	59.95	-		
CTC: 12"	US26	59.95	-		
Door Thickness: 1-3/4" standard	US26D	59.95	017368		
Fasteners: 1/4" x 2-1/4" FPHMS with washers	US32	62.50	064516		
Not suitable for BTB Mounting.	US32D	53.50	075733		

1. Items with the price in **bold and red** are Quick Ship items and ship in 24 hours.
Please use stock number when ordering. 2. U/M is each unless otherwise noted.



Trim & Auxiliary

	Description	Finish	2021 List	Stock No.	Box Qty.	Case Qty.
	10L					
	Pull - Round	US3	274.00	079250	1	8
	Material: Brass, bronze, stainless steel	US4	274.00	094670		
	Base: 1-1/4" diameter	US10	304.15	002193		
	Projection: 3"	US10B	380.20	084947		
	Clearance: 1-3/4"	DBZ	304.15	-		
	CTC: 12"	US26	304.15	030731		
	Door Thickness: 1-3/4" standard	US26D	304.15	023472		
Fasteners: 5/16" - 18 x 2-1/4" FPHMS with washers	US32	271.80	097312			
	US32D	230.75	067649			
	10Q					
	Pull - Round	US3	300.60	090612	2	8
	Material: Brass, bronze, stainless steel	US4	300.60	010843		
	Base: 1-1/4" diameter	US10	321.70	034458		
	Projection: 3"	US10B	402.15	087786		
	Clearance: 1-3/4"	DBZ	321.70	-		
	CTC: 18"	US26	321.70	-		
	Door Thickness: 1-3/4" standard	US26D	321.70	039520		
Fasteners: 5/16" - 18 x 2-1/4" FPHMS with washers	US32	281.90	027254			
	US32D	261.50	072664			
	11E					
	90° Offset Pull - Round	US3	83.05	059597	-	2
	Material: Brass, bronze, aluminum, stainless steel	US4	83.05	018312		
	Base: 3/4" diameter	US10	86.85	060336		
	Projection: 2-1/2"	US10B	108.55	060315		
	Clearance: 1-3/4"	DBZ	86.85	-		
	CTC: 6"	US26	86.85	040696		
	Offset: 2-1/2"	US26D	86.85	075266		
Door Thickness: 1-3/4" standard	US28	54.50	043401			
Fasteners: 5/16" - 18 x 2-1/4" FPHMS with washers	US32	88.75	-			
Available with 45° offset	US32D	69.25	057380			
	11G					
	90° Offset Pull - Round	US3	87.50	063681	-	2
	Material: Brass, bronze, aluminum, stainless steel	US4	87.50	047133		
	Base: 3/4" diameter	US10	92.70	097774		
	Projection: 2-1/2"	US10B	115.90	068662		
	Clearance: 1-3/4"	DBZ	92.70	-		
	CTC: 8"	US26	92.70	013867		
	Offset: 2-1/2"	US26D	92.70	093586		
Door Thickness: 1-3/4" standard	US28	61.70	067803			
Fasteners: 5/16" - 18 x 2-1/4" FPHMS with washers	US32	94.15	109006			
Available with 45° offset	US32D	76.05	066983			





Description	Finish	2021 List	Stock No.	Box Qty.	Case Qty.
11J					
90° Offset Pull - Round	US3	92.60	073589	-	2
Material: Brass, bronze, aluminum, stainless steel	US4	92.60	087629		
Base: 3/4" diameter	US10	100.55	074842		
Projection: 2-1/2"	US10B	125.65	056958		
Clearance: 1-3/4"	DBZ	100.55	-		
CTC: 10"	US26	100.55	064743		
Offset: 2-1/2"	US26D	100.55	091336		
Door Thickness: 1-3/4" standard	US28	65.20	075928		
Fasteners: 5/16" - 18 x 2-1/4" FPHMS with washers	US32	97.80	091535		
Available with 45° offset	US32D	79.60	066497		



11L					
90° Offset Pull - Round	US3	100.55	096446	-	2
Material: Brass, bronze, aluminum, stainless steel	US4	100.55	-		
Base: 3/4" diameter	US10	112.70	023215		
Projection: 2-1/2"	US10B	140.85	070692		
Clearance: 1-3/4"	DBZ	112.70	-		
CTC: 12"	US26	112.70	062866		
Offset: 2-1/2"	US26D	112.70	086064		
Door Thickness: 1-3/4" standard	US28	69.95	073571		
Fasteners: 5/16" - 18 x 2-1/4" FPHMS with washers	US32	105.00	078494		
Available with 45° offset	US32D	85.05	065800		



12G					
90° Offset Pull - Round	US3	111.55	060314	-	2
Material: Brass, bronze, aluminum, stainless steel	US4	111.55	081233		
Base: 1" diameter	US10	128.05	043913		
Projection: 2-3/4"	US10B	160.05	076432		
Clearance: 1-3/4"	DBZ	128.05	-		
CTC: 8"	US26	128.05	078220		
Offset: 3"	US26D	128.05	062954		
Door Thickness: 1-3/4" standard	US28	56.75	070404		
Fasteners: 5/16" - 18 x 2-1/4" FPHMS with washers	US32	110.60	099416		
Available with 45° offset	US32D	90.20	060905		



12J					
90° Offset Pull - Round	US3	116.50	060159	-	2
Material: Brass, bronze, aluminum, stainless steel	US4	116.50	082215		
Base: 1" diameter	US10	130.70	069370		
Projection: 2-3/4"	US10B	158.65	059163		
Clearance: 1-3/4"	DBZ	130.70	-		
CTC: 10"	US26	130.70	059778		
Offset: 3"	US26D	130.70	068450		
Door Thickness: 1-3/4" standard	US28	62.85	070967		
Fasteners: 5/16" - 18 x 2-1/4" FPHMS with washers	US32	122.90	059561		
Available with 45° offset	US32D	97.20	055174		

1. Items with the price in **bold and red** are Quick Ship items and ship in 24 hours.
Please use stock number when ordering. 2. U/M is each unless otherwise noted.



Trim & Auxiliary



Description	Finish	2021 List	Stock No.	Box Qty.	Case Qty.
12L					
90° Offset Pull - Round	US3	124.35	056782	-	2
Material: Brass, bronze, aluminum, stainless steel	US4	124.35	063686		
Base: 1" diameter	US10	138.90	059327		
Projection: 2-3/4"	US10B	173.60	061587		
Clearance: 1-3/4"	DBZ	138.90	41947		
CTC: 12"	US26	138.90	076229		
Offset: 3"	US26D	138.90	077083		
Door Thickness: 1-3/4" standard	US28	68.70	062011		
Fasteners: 5/16" - 18 x 2-1/4" FPHMS with washers	US32	135.25	067052		
Available with 45° offset	US32D	101.10	059815		



13E					
Push/Pull Set - Round	US3	131.95	061785	1	12
Type 7 mounting	US4	131.95	095631		
Material: Brass, bronze, aluminum, stainless steel	US10	134.45	002512		
Base: 3/4" diameter	US10B	168.10	028794		
Projection: 2-1/4"	DBZ	134.45	-		
Clearance: 1-1/2"	US26	134.45	063688		
Door Thickness: 1-3/4"	US26D	134.45	060821		
CTC: 6"	US28	91.65	076294		
BTB Mounting type 7 concealed spanner (Required 3/8" min. holes in door)	US32	147.35	020838		
	US32D	120.70	055892		



13G					
Push/Pull Set - Round	US3	151.50	002452	1	12
Type 7 mounting	US4	151.50	018605		
Material: Brass, bronze, aluminum, stainless steel	US10	157.15	056543		
Base: 3/4" diameter	US10B	196.40	057132		
Projection: 2-1/4"	DBZ	157.15	-		
Clearance: 1-1/2"	US26	157.15	058650		
Door Thickness: 1-3/4"	US26D	157.15	096884		
CTC: 8"	US28	100.20	057936		
BTB Mounting type 7 concealed spanner (Required 3/8" min. holes in door)	US32	168.15	016398		
	US32D	130.80	059203		



13J					
Push/Pull Set - Round	US3	167.25	067010	1	12
Type 7 mounting	US4	167.25	058379		
Material: Brass, bronze, aluminum, stainless steel	US10	174.85	013815		
Base: 3/4" diameter	US10B	218.55	006667		
Projection: 2-1/4"	DBZ	174.85	-		
Clearance: 1-1/2"	US26	174.85	043759		
Door Thickness: 1-3/4"	US26D	174.85	068292		
CTC: 10"	US28	112.30	014475		
BTB Mounting type 7 concealed spanner (Required 3/8" min. holes in door)	US32	185.65	032231		
	US32D	143.15	063863		





Description	Finish	2021 List	Stock No.	Box Qty.	Case Qty.
13L					
Push/Pull Set - Round	US3	180.15	095055	1	12
Type 7 mounting	US4	180.15	110600		
Material: Brass, bronze, aluminum, stainless steel	US10	204.50	060284		
Base: 3/4" diameter	US10B	255.65	039979		
Projection: 2-1/4"	DBZ	204.50	-		
Clearance: 1-1/2"	US26	204.50	070322		
Door Thickness: 1-3/4"	US26D	204.50	070163		
CTC: 12"	US28	125.30	037236		
BTB Mounting type 7 concealed spanner (Required 3/8" min. holes in door)	US32	198.90	034594		
	US32D	164.75	084896		

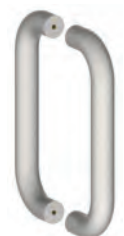

14G					
Push/Pull Set - Round					
Type 7 mounting	US3	189.35	056325	1	12
Material: Brass, bronze, aluminum, stainless steel	US4	189.35	123899		
Base: 1" diameter	US10	203.65	027836		
Projection: 2-3/4"	US10B	254.55	019363		
Clearance: 1-3/4"	DBZ	203.65	-		
Door Thickness: 1-3/4"	US26	203.65	029353		
CTC: 8"	US26D	203.65	077790		
BTB Mounting type 7 concealed spanner (Required 3/8" min. holes in door)	US28	130.00	091532		
	US32	220.10	088849		
	US32D	177.15	070068		



14H					
Push/Pull Set - Round					
Type 7 mounting	US3	208.50	125548	1	12
Material: Brass, bronze, aluminum, stainless steel	US4	219.15	143956		
Base: 1" diameter	US10	221.20	-		
Projection: 2-3/4"	US10B	276.50	018727		
Clearance: 1-3/4"	DBZ	221.20	-		
Door Thickness: 1-3/4"	US26	221.20	-		
CTC: 9"	US26D	221.20	034117		
BTB Mounting type 7 concealed spanner (Required 3/8" min. holes in door)	US28	130.25	147101		
	US32	244.95	-		
	US32D	190.05	024734		



14J					
Push/Pull Set - Round					
Type 7 mounting	US3	210.20	056432	1	8
Material: Brass, bronze, aluminum, stainless steel	US4	210.20	028831		
Base: 1" diameter	US10	222.90	066033		
Projection: 2-3/4"	US10B	278.60	060441		
Clearance: 1-3/4"	DBZ	222.90	-		
Door Thickness: 1-3/4"	US26	222.90	059309		
CTC: 10"	US26D	222.90	061594		
BTB Mounting type 7 concealed spanner (Required 3/8" min. holes in door)	US28	131.75	014601		
	US32	246.50	084135		
	US32D	191.60	067342		

1. Items with the price in **bold and red** are Quick Ship items and ship in 24 hours.
Please use stock number when ordering. 2. U/M is each unless otherwise noted.



Trim & Auxiliary



Description	Finish	2021 List	Stock No.	Box Qty.	Case Qty.
14L					
Push/Pull Set - Round	US3	218.35	086803	1	8
Type 7 mounting	US4	218.35	083099		
Material: Brass, bronze, aluminum, stainless steel	US10	249.15	071917		
Base: 1" diameter	US10B	311.45	071108		
Projection: 2-3/4"	DBZ	249.15	-		
Clearance: 1-3/4"	US26	249.15	010126		
Door Thickness: 1-3/4"	US26D	249.15	023138		
CTC: 12"	US28	146.00	100725		
BTB Mounting type 7 concealed spanner (Required 3/8" min. holes in door)	US32	267.40	063460		
	US32D	216.85	057010		



15C					
Heavy Duty Flush Cup Pull					
Material: Stainless steel					
Face: 3-1/2" x 5"	US32D	66.60	026410	1	10
Opening: 1-3/4" x 3-1/16"					
Projection: 1/8"					
Cup Depth: 3/4" (Cup welded to face plate)					
Fasteners: #6 x5/8" OPHWS					



15N					
Flush Cup Pull					
Material: Brass, bronze, aluminum, stainless steel	US3	59.75	053114	2	20
Face: 3-1/2" x 5"	US4	69.65	053115		
Opening: 1-3/4" x 3-1/16"	US10	68.70	053116		
Projection: 1/8"	US10B	85.90	053117		
Cup Depth: 3/4"	DBZ	68.70	-		
Fasteners: #6 x5/8" OPHWS	US26	68.70	053118		
	US26D	64.40	053119		
	US28	25.90	053120		
	US32D	33.50	053121		



15P					
Heavy Duty Security Flush Cup Pull					
Material: Stainless steel					
Face: 3-1/2" x 5"	US32D	70.50	085266	2	20
Opening: 1-3/4" x 3-1/16"					
Projection: 3/16"					
Cup Depth: 3/4" (Cup welded to face plate)					
Welded studs for security (2) 6 -32 x 1-1/2" FPHMS (security torx)					





Description	Finish	2021 List	Stock No.	Box Qty.	Case Qty.
15S					
Light Duty Flush Cup Pull	US3	53.60	014360	2	20
Material: Brass, bronze, aluminum, stainless steel	US4	60.70	039342		
Face: 3-1/2" x 5"	US10	68.70	025946		
Opening: 1-3/4" x 3-1/16"	US10B	85.90	042147		
Projection: 1/8"	DBZ	68.70	-		
Cup Depth: 3/4"	US26	68.70	089124		
Fasteners: #6 x 5/8" PPHWS	US26D	68.70	020841		
Fasteners inside recessed cup	US28	43.55	091301		
	US32D	45.20	017661		



16N					
Light Duty Flush Cup Pull	US3	25.15	073983	2	20
Material: Brass, bronze	US4	32.45	010007		
Face: 1-15/16" x 3"	US10	26.05	074227		
Opening: 27/32" x 2-3/8"	US10B	32.55	068253		
Projection: 1/16"	US26	32.45	068254		
Cup Depth: 5/8"	US26D	26.05	067702		
Fasteners: #8 x 3/4" OPHWS					
Fasteners inside recessed cup					



16R					
Finger Pull Plate	US3	76.95	018081	2	20
Material: Brass, bronze, aluminum, stainless steel	US4	84.30	141082		
Size: 4" x 16"	US10	84.30	-		
Opening: 1-3/4" x 3-1/16"	US10B	105.40	060151		
Cup Depth: 13/16"	DBZ	84.30	--		
Fasteners: #6 x 5/8" OPHWS	US26	84.30	085308		
	US26D	84.30	009524		
	US28	59.00	092065		
	US32	95.00	-		
	US32D	65.65	057855		



17N					
Light Duty Flush Cup Pull	US3	22.10	068535	2	20
Material: Brass, bronze	US4	28.50	077871		
Face: 2-1/2" x 3-31/32"	US10	23.50	068096		
Opening: 1-11/32" x 3-13/32"	US10B	29.35	068255		
Projection: 3/32"	US26	28.50	068256		
Cup Depth: 5/8"	US26D	22.65	067507		
Fasteners: #8 x 13/16" OPHWS					
Fasteners inside recessed cup					

1. Items with the price in **bold and red** are Quick Ship items and ship in 24 hours.
Please use stock number when ordering. 2. U/M is each unless otherwise noted.



Trim & Auxiliary



Description	Finish	2021 List	Stock No.	Box Qty.	Case Qty.
19N					
Cast Pull	US3	69.85	-	1	20
Material: Brass, bronze	US10	72.65	072477		
Base Diameter: 1-1/2"	US10B	93.65	076217		
Projection: 3-1/8"	DBZ	74.95	-		
Clearance: 1-11/16"	US26	74.95	-		
CTC: 6-3/16"	US26D	74.95	064247		
Length O/A: 9"					
Fasteners: #8 x 1" OPHWS					
Suitable for BTB Mounting with sex nuts by special quotation					



20N					
Cast Pull					
Material: Brass, bronze					
Base Diameter: 1-1/2"					
Projection: 3-1/8"	US3	69.85	058572	1	1
Clearance: 1-11/16"	US10	74.95	033608		
CTC: 5-7/32"	US10B	93.65	095243		
Length O/A: 9"	DBZ	74.95	--		
Fasteners: 1/4" - 20 thru bolts with washers	US26	74.95	017678		
Door Thickness: 1-3/4" standard	US26D	74.95	058574		
Not suitable for BTB Mounting					



20L					
Push/Pull Set - Round	US3	594.55	140460	1	4
Type 7 mounting	US4	628.40	090986		
Material: Brass, bronze, stainless steel	US10	628.40	-		
Base: 1-1/4" diameter	US10B	785.50	019165		
Projection: 3"	DBZ	628.40	-		
Clearance: 1-3/4"	US26	628.40	052420		
CTC: 12"	US26D	628.40	022949		
Door Thickness: 1-3/4" standard	US28	628.40	-		
BTB Mounting type 7 concealed spanner (Required 7/16" min. holes in door)	US32	555.80	030891		
	US32D	518.85	099136		



20Q					
Push/Pull Set - Round					
Type 7 mounting					
Material: Brass, bronze, stainless steel	US3	660.70	184392	1	4
Base: 1-1/4" diameter	US4	698.30	-		
Projection: 3"	US10	698.30	-		
Clearance: 1-3/4"	US10B	872.85	105155		
CTC: 18"	DBZ	698.30	-		
Door Thickness: 1-3/4" standard	US26	698.30	163164		
BTB Mounting type 7 concealed spanner (Required 7/16" min. holes in door)	US26D	698.30	046330		
	US28	698.30	-		
	US32	430.05	066386		
	US32D	576.55	067607		





Description	Finish	2021 List	Stock No.	Box Qty.	Case Qty.
21E					
90° Offset Push/Pull Set - Round	US3	208.10	138354	-	1
Material: Brass, bronze, aluminum, stainless steel	US4	208.10	-		
Base: 3/4" diameter	US10	218.00	-		
Projection: 2-1/2"	US10B	272.50	012325		
Clearance: 1-3/4"	DBZ	218.00	-		
CTC: 6"	US26	218.00	071225		
Offset: 2-1/2"	US26D	218.00	028763		
Door Thickness: 1-3/4" standard	US28	151.85	019295		
BTB Mounting Type 7 concealed spanner (Required 3/8" minimum holes in door)	US32	220.45	161045		
Available with 45° offset	US32D	181.60	089757		



21G					
90° Offset Push/Pull Set - Round	US3	219.40	058679	-	1
Material: Brass, bronze, aluminum, stainless steel	US4	219.40	043225		
Base: 3/4" diameter	US10	229.60	-		
Projection: 2-1/2"	US10B	287.00	063310		
Clearance: 1-3/4"	DBZ	229.60	-		
CTC: 8"	US26	229.60	018016		
Offset: 2-1/2"	US26D	229.60	066826		
Door Thickness: 1-3/4" standard	US28	166.35	075590		
BTB Mounting Type 7 concealed spanner (Required 3/8" minimum holes in door)	US32	221.40	025013		
Available with 45° offset	US32D	195.15	058003		



21J					
90° Offset Push/Pull Set - Round	US3	226.80	078909	-	1
Material: Brass, bronze, aluminum, stainless steel	US4	226.80	-		
Base: 3/4" diameter	US10	245.10	005255		
Projection: 2-1/2"	US10B	306.35	057372		
Clearance: 1-3/4"	DBZ	245.10	-		
CTC: 10"	US26	245.10	005678		
Offset: 2-1/2"	US26D	245.10	067008		
Door Thickness: 1-3/4" standard	US28	170.60	112219		
BTB Mounting Type 7 concealed spanner (Required 3/8" minimum holes in door)	US32	238.45	019770		
Available with 45° offset	US32D	202.40	080009		



21L					
90° Offset Push/Pull Set - Round	US3	241.70	097140	-	1
Material: Brass, bronze, aluminum, stainless steel	US4	241.70	002578		
Base: 3/4" diameter	US10	269.55	-		
Projection: 2-1/2"	US10B	336.95	042312		
Clearance: 1-3/4"	DBZ	269.55	--		
CTC: 12"	US26	269.55	007396		
Offset: 2-1/2"	US26D	269.55	032790		
Door Thickness: 1-3/4" standard	US28	182.65	047803		
BTB Mounting Type 7 concealed spanner (Required 3/8" minimum holes in door)	US32	252.95	027578		
Available with 45° offset	US32D	213.25	069905		

1. Items with the price in **bold and red** are Quick Ship items and ship in 24 hours. Please use stock number when ordering. 2. U/M is each unless otherwise noted.



Trim & Auxiliary



Description	Finish	2021 List	Stock No.	Box Qty.	Case Qty.
22G					
90° Offset Push/Pull Set - Round	US3	262.80	079012	-	1
Material: Brass, bronze, aluminum, stainless steel	US4	262.80	167031		
Base: 1" diameter	US10	294.60	075421		
Projection: 2-3/4"	US10B	368.25	096184		
Clearance: 1-3/4"	DBZ	294.60	-		
CTC: 8"	US26	294.60	048693		
Offset: 3"	US26D	294.60	007328		
Door Thickness: 1-3/4" standard	US28	160.10	024277		
BTB Mounting Type 7 concealed spanner (Required 3/8" minimum holes in door)	US32	264.55	098201		
Available with 45° offset	US32D	260.90	067908		



22J					
90° Offset Push/Pull Set - Round	US3	277.15	075192	-	1
Material: Brass, bronze, aluminum, stainless steel	US4	277.15	175712		
Base: 1" diameter	US10	310.45	050773		
Projection: 2-3/4"	US10B	388.05	058192		
Clearance: 1-3/4"	DBZ	310.45	-		
CTC: 10"	US26	310.45	005787		
Offset: 3"	US26D	310.45	085517		
Door Thickness: 1-3/4" standard	US28	172.10	002376		
BTB Mounting Type 7 concealed spanner (Required 3/8" minimum holes in door)	US32	288.75	073277		
Available with 45° offset	US32D	281.10	076699		







22L					
90° Offset Push/Pull Set - Round	US3	291.50	073970	-	1
Material: Brass, bronze, aluminum, stainless steel	US4	291.50	078417		
Base: 1" diameter	US10	329.65	000477		
Projection: 2-3/4"	US10B	412.05	080383		
Clearance: 1-3/4"	DBZ	329.65	-		
CTC: 12"	US26	329.65	015975		
Offset: 3"	US26D	329.65	038687		
Door Thickness: 1-3/4" standard	US28	183.90	000794		
BTB Mounting Type 7 concealed spanner (Required 3/8" minimum holes in door)	US32	312.60	059202		
Available with 45° offset	US32D	301.70	064503		



22N					
Concealed Edge Pull	US3	74.10	086819	1	10
Material: Solid brass	US26D	80.55	086820		
Size: 31/32" x 4-1/4" x 3/8"					
Finger piece extends: 2-3/4"					
Fasteners: #6 x 3/4" FPHWS					









	Description	Finish	2021 List	Stock No.	Box Qty.	Case Qty.	
	23Q						
	90° Offset Pull - Round	US3	371.85	006390	-	2	
	Material: Brass, bronze, aluminum, stainless steel	US4	371.85	029999			
	Base Diameter: 1-1/4"	US10	391.90	021472			
	Projection: 3"	US10B	489.90	017369			
	Clearance: 1-3/4"	DBZ	391.90	--			
	CTC: 18"	US26	391.90	019785			
	Diamond plate available at price of US10	US26D	391.90	023673			
	Offset: 3-3/4" standard	US28	139.50	049363			
	Fasteners: 5/16" - 18 thru bolt w/ washer Door Thickness: 1-3/4" standard with 45° offset	US32	342.00	002751			
	US32D	293.15	080011				
	24Q						
	90° Offset Push/Pull Set - Round	US3	791.40	003843	-	1	
	Material: Brass, bronze, aluminum, stainless steel	US4	791.40	134285			
	Base Diameter: 1-1/4"	US10	831.40	043201			
	Projection: 3"	US10B	1,039.25	024989			
	Clearance: 1-3/4"	DBZ	831.40	-			
	CTC: 18"	US26	831.40	-			
	Offset: 3-3/4"	US26D	831.40	-			
	Door Thickness: 1-3/4" standard	US28	298.10	095347			
	BTB Mounting Type 7 concealed spanner (Required 3/8" minimum holes in door) Available with 45° offset	US32	732.30	-			
	US32D	632.80	067055				
	190F						
	Foot Pull	Powder Coated Aluminum	70.45	39832	-	100	
	Material: T6 aluminum Projection: 3" Door Thickness: 1-3/4" standard Fasteners: (3) #12 screws suitable for wood/metal doors + (1) sex nut & bolt						
	25B						
	Security Flush Pull Set	US32D	135.65	025035	1	10	
	Material: Stainless steel Face: 3-1/2" x 5" Opening: 1-3/4" x 3-1/16" Projection: 3/16" Cup Depth: 3/4" Fasteners: (2) 6 - 32 x 1-1/2" FPHMS (security torx)						
	25C						
	Heavy Duty Flush Pull Set	US32D	131.60	008405	1	10	
	Material: Stainless steel Face: 3-1/2" x 5" Opening: 1-3/4" x 3-1/16" Projection: 1/8" Cup Depth: 3/4" Fasteners: (4) 6 -32 OPHMS with sex nuts and bolts Consists of 2 ea. 15C pulls BTB						

1. Items with the price in **bold and red** are Quick Ship items and ship in 24 hours. Please use stock number when ordering. 2. U/M is each unless otherwise noted.



Trim & Auxiliary

	Description	Finish	2021 List	Stock No.	Box Qty.	Case Qty.
	25N					
	Flush Pull Set	US3	131.65	057171	1	10
	Material: Brass, bronze, aluminum, stainless steel	US4	131.65	069686		
	Face: 3-1/2" x 5"	US10	135.45	064913		
	Opening: 1-3/4" x 3-1/16"	US10B	169.30	075384		
	Projection: 1/8"	DBZ	135.45	-		
	Cup Depth: 3/4"	US26	135.45	087487		
	Fasteners: (4) 6 -32 OPHMS with sex nuts and bolts Consists of 2 ea. 15N pulls BTB	US26D	135.45	055307		
	US28	100.90	074843			
	US32D	56.65	066502			
	25P					
	Security Finger Pull/Push Plate Set	US32D	275.90	089518	1	10
	Material: Stainless steel					
	Base: 4" x 16"					
	Opening: 1-3/4" x 3-1/16"					
Projection: 1/8"						
Fasteners: 8 - 32 x 3/4" FPHMS (security torx) sex nuts and bolts						
	26N					
	Security Finger Pull	US4	73.45	024671	2	20
	Material: Brass, stainless steel	US26	100.55	036321		
	Face: 4" x 5"	US32D	105.65	017790		
Opening: 1-5/8" x 3"						
Projection: 1/8"						
Cup Depth: 13/16"						
Fasteners: 1/4" - 20 x 3/4" security torx FPHMS						
 	27N					
	Security Flush Cup Pull	US32D	137.35	006749	2	20
	Material: Stainless steel					
	Face: 5" x 5"					
	Opening: 3" x 3-1/2"					
	Projection: 3/8"					
Cup Depth: 7/8"						
Fasteners: 10 - 24 FPHMS (security torx) sex nuts and thru bolts Not available for BTB Mounting						
 	27P					
	Security Flush Cup Pull	US32D	137.35	013714	2	20
	Material: Stainless steel					
	Face: 5" x 5"					
	Opening: 3" x 3-1/2"					
	Projection: 3/8"					
Cup Depth: 7/8"						
Fasteners: 1/4" - 20 x 3/4" FPHMS (security torx) Not available for BTB Mounting						





Description	Finish	2021 List	Stock No.	Box Qty.	Case Qty.
30S					
Push-Plate - Square Corner					
Material: Brass, bronze, aluminum, stainless steel					
Gauge: 0.050					
Fasteners: #6 x 5/8" OPH tapping screws					
3" x 12"					
	US3	17.60	052473	5	50
	US4	17.60	053057		
	US10	21.00	052603		
	US10B	26.25	052604		
	DBZ	21.00	-		
	US26	21.00	052788		
	US26D	21.00	052605		
	US28	11.05	052606		
	US32	15.85	060400		
	US32D	12.90	052607		
<hr/>					
3-1/2" x 15					
	US3	23.75	051947	5	50
	US4	25.25	053058		
	US10	28.85	052474		
	US10B	36.05	052475		
	DBZ	28.85	042052		
	US26	28.85	051948		
	US26D	27.80	052608		
	US28	10.50	051949		
	US32	14.40	067703		
	US32D	10.80	052476		
<hr/>					
4" x 16"					
	US3	27.80	052477	5	50
	US4	27.30	053059		
	US10	30.40	052478		
	US10B	38.00	052479		
	DBZ	30.40	042048		
	US26	30.40	052789		
	US26D	29.35	052480		
	US28	11.75	052481		
	US32	15.95	056570		
	US32D	11.40	052482		
<hr/>					
6" x 16"					
	US3	39.65	052609		5
	US4	39.65	016001		
	US10	44.80	052610		
	US10B	56.00	052611		
	DBZ	44.80	-		
	US26	44.80	052612		
	US26D	43.80	052613		
	US28	16.20	052614		
	US32	24.10	059757		
	US32D	16.20	052615		
<hr/>					
8" x 16"					
	US3	48.75	052616		5
	US4	48.75	053054		
	US10	55.95	052617		
	US10B	69.90	052618		
	DBZ	55.95	42049		
	US26	55.95	052619		
	US26D	54.90	052620		
	US28	18.10	052621		
	US32	30.15	056697		
	US32D	22.05	052483		

1. Items with the price in **bold and red** are Quick Ship items and ship in 24 hours.
Please use stock number when ordering. 2. U/M is each unless otherwise noted.



Trim & Auxiliary



Description	Finish	2021 List	Stock No.	Box Qty.	Case Qty.
A30S					
Push-Plate - Square Corner					
Material: Brass, bronze, aluminum, stainless steel					
Gauge: 0.062					
Fasteners: #6 x 5/8" OPH tapping screws					
3" x 12"	US3	28.95	088064	5	50
	US4	28.95	040610		
	US10	33.60	089728		
	US10B	41.95	057228		
	DBZ	33.60	-		
	US26	33.60	083774		
	US26D	33.60	002164		
	US28	14.15	161252		
	US32	26.90	154189		
	US32D	17.25	018593		
<hr/>					
3-1/2" x 15	US3	31.20	086010	5	50
	US4	31.20	125264		
	US10	37.75	060451		
	US10B	47.20	095370		
	DBZ	37.75	-		
	US26	37.75	041812		
	US26D	37.75	050973		
	US28	15.75	095372		
	US32	32.75	014761		
	US32D	21.90	095371		
<hr/>					
4" x 16"	US3	35.30	088141	5	50
	US4	35.30	096314		
	US10	41.55	018240		
	US10B	51.95	026224		
	DBZ	41.55	-		
	US26	41.55	068218		
	US26D	41.55	088369		
	US28	17.00	098928		
	US32	34.45	71242		
	US32D	23.95	084940		
<hr/>					
6" x 16"	US3	51.15	146109		5
	US4	51.15	147465		
	US10	57.45	008731		
	US10B	71.85	094683		
	DBZ	57.45	-		
	US26	57.45	098852		
	US26D	57.45	001249		
	US28	22.30	098000		
	US32	58.50	-		
	US32D	39.85	052271		
<hr/>					
8" x 16"	US3	55.30	046204		5
	US4	55.30	065722		
	US10	61.55	089364		
	US10B	76.95	025549		
	DBZ	61.55	-		
	US26	61.55	053802		
	US26D	61.55	092477		
	US28	29.65	155732		
	US32	72.10	104412		
	US32D	44.60	081011		

1. Items with the price in **bold and red** are Quick Ship items and ship in 24 hours.
Please use stock number when ordering. 2. U/M is each unless otherwise noted.



Description	Finish	2021 List	Stock No.	Box Qty.	Case Qty.
31E					
Pull Plate - Square Corner - Half Round Pull					
Material: Brass, bronze, aluminum, stainless steel					
Gauge: 0.050; CTC: 6"					
30S x 1E Pull					
Fasteners: #6 x 5/8" OPH tapping screws					
	US3	81.90	056433	1	10
	US4	81.90	060011		
	US10	87.05	055633		
	US10B	108.80	058712		
	DBZ	87.05	-		
	US26	87.05	078715		
	US26D	81.90	054517		
	US28	39.65	054428		
	US32	82.20	071221		
	US32D	58.70	054029		
4" x 16"	US3	82.90	052652	1	10
	US4	82.90	053049		
	US10	88.05	052653		
	US10B	110.10	052493		
	DBZ	88.05			
	US26	88.05	052800		
	US26D	83.15	054341		
	US28	40.70	052654		
	US32	92.70	062509		
	US32D	70.25	052494		



31G					
Pull Plate - Square Corner - Half Round Pull					
Material: Brass, bronze, aluminum, stainless steel					
Gauge: 0.050; CTC: 8"					
30S x 1G Pull					
Fasteners: #6 x 5/8" OPH tapping screws					
	US3	83.40	058350	1	10
	US4	83.40	085438		
	US10	91.55	057757		
	US10B	114.45	058681		
	DBZ	91.55	-		
	US26	91.55	064372		
	US26D	91.55	058351		
	US28	43.80	055483		
	US32	102.90	041049		
	US32D	66.95	055482		
4" x 16"	US3	88.60	056514	1	10
	US4	88.60	064373		
	US10	93.15	058057		
	US10B	116.45	059416		
	DBZ	93.15	-		
	US26	93.15	059035		
	US26D	93.15	056759		
	US28	46.35	056350		
	US32	108.95	095219		
	US32D	68.00	055297		

1. Items with the price in **bold and red** are Quick Ship items and ship in 24 hours.
Please use stock number when ordering. 2. U/M is each unless otherwise noted.



Trim & Auxiliary



Description	Finish	2021 List	Stock No.	Box Qty.	Case Qty.
31J					
Pull Plate - Square Corner - Half Round Pull					
Material: Brass, bronze, aluminum, stainless steel					
Gauge: 0.050; CTC: 10"					
30S x 1J Pull					
Fasteners: #6 x 5/8" OPH tapping screws					
3-1/2" x 15"	US3	94.85	011268	1	10
	US4	98.80	065208		
	US10	102.35	700006		
	US10B	127.90	067881		
	DBZ	102.35	-		
	US26	102.35	-		
	US26D	103.35	081194		
	US28	50.80	116104		
	US32	114.50	077157		
	US32D	88.75	056322		
4" x 16"	US3	96.65	125465	1	10
	US4	100.00	049246		
	US10	106.10	063316		
	US10B	132.60	062373		
	DBZ	106.10	-		
	US26	106.10	-		
	US26D	106.10	021574		
	US28	53.10	050497		
	US32	107.90	068294		
	US32D	92.25	062377		



32E					
Pull Plate - Square Corner - Rectangular Pull					
Material: Brass, bronze, aluminum, stainless steel					
Gauge: 0.050; CTC: 6"					
Fasteners: #6 x 5/8" OPH tapping screws					
30S x 2E Pull					
3-1/2" x 15"	US3	65.60	052642	1	10
	US4	62.80	053047		
	US10	81.90	052643		
	US10B	102.35	052644		
	DBZ	81.90	-		
	US26	81.90	052797		
	US26D	81.90	052645		
	US28	34.50	052646		
	US32	68.95	067882		
	US32D	48.40	052647		
4" x 16"	US3	73.15	052648	1	10
	US4	73.15	053048		
	US10	83.95	052798		
	US10B	104.95	052492		
	DBZ	83.95	-		
	US26	83.95	052799		
	US26D	83.95	052649		
	US28	36.55	052650		
	US32	79.65	060399		
	US32D	50.45	052651		





Description	Finish	2021 List	Stock No.	Box Qty.	Case Qty.
32G					
Pull Plate - Square Corner - Rectangular Pull					
Material: Brass, bronze, aluminum, stainless steel					
Gauge: 0.050; CTC: 8"					
Fasteners: #6 x 5/8" OPH tapping screws					
30S x 2G Pull					
3-1/2" x 15"					
	US3	75.90	059981	1	10
	US4	75.90	085113		
	US10	88.65	163347		
	US10B	110.10	066040		
	DBZ	88.05	-		
	US26	88.65	-		
	US26D	87.05	060646		
	US28	45.85	063926		
	US32	88.75	-		
	US32D	61.80	055010		
4" x 16"	US3	87.05	054727	1	10
	US4	87.05	003510		
	US10	92.20	056784		
	US10B	115.25	056756		
	DBZ	92.20	-		
	US26	91.65	065122		
	US26D	92.20	069514		
	US28	49.95	069513		
	US32	96.05	017637		
	US32D	65.90	055389		



32J					
Pull Plate - Square Corner - Rectangular Pull					
Material: Brass, bronze, aluminum, stainless steel					
Gauge: 0.050; CTC: 10"					
Fasteners: #6 x 5/8" OPH tapping screws					
30S x 2J Pull					
3-1/2" x 15"					
	US3	88.65	043039	1	10
	US4	91.20	-		
	US10	97.55	118724		
	US10B	121.95	022532		
	DBZ	97.55	-		
	US26	97.55	-		
	US26D	97.55	-		
	US28	41.85	-		
	US32	105.40	-		
	US32D	88.75	019279		
4" x 16"	US3	92.10	032063	1	10
	US4	97.10	139843		
	US10	100.55	117572		
	US10B	125.65	005155		
	DBZ	100.55	-		
	US26	100.55	029867		
	US26D	100.55	044540		
	US28	45.40	-		
	US32	109.85	040153		
	US32D	94.15	069243		

1. Items with the price in **bold and red** are Quick Ship items and ship in 24 hours.
Please use stock number when ordering. 2. U/M is each unless otherwise noted.



Trim & Auxiliary



Description	Finish	2021 List	Stock No.	Box Qty.	Case Qty.
33E					
Pull Plate - Square Corner - 3/4" Round Pull					
Material: Brass, bronze, aluminum, stainless steel	US3	69.00	052655	1	10
Gauge: 0.050; CTC:6"	US4	69.00	053044		
Fasteners: #6 x 5/8" OPH tapping screws	US10	77.75	052656		
30S x 3E Pull	US10B	97.20	052657		
3-1/2" x 15"	DBZ	77.75	41990		
	US26	77.75	052801		
	US26D	77.75	052658		
	US28	33.50	052659		
	US32	56.65	074228		
	US32D	38.50	052660		
4" x 16"	US3	75.20	052661	1	10
	US4	75.20	016002		
	US10	81.65	053045		
	US10B	102.05	052662		
	DBZ	81.65	41986		
	US26	81.65	052802		
	US26D	81.65	052663		
	US28	37.60	052664		
	US32	63.85	056516		
	US32D	39.65	052665		



33G					
Pull Plate - Square Corner - 3/4" Round Pull					
Material: Brass, bronze, aluminum, stainless steel					
Gauge: 0.050; CTC: 8"	US3	77.25	052667	1	10
Fasteners: #6 x 5/8" OPH tapping screws	US4	77.25	053046		
30S x 3GPull	US10	85.00	052495		
3-1/2" x 15"	US10B	106.20	052668		
	DBZ	85.00	-		
	US26	85.00	052803		
	US26D	78.30	052669		
	US28	36.55	052670		
	US32	61.80	002398		
	US32D	38.75	052666		
4" x 16"	US3	82.50	052671	1	10
	US4	82.50	053060		
	US10	90.15	052672		
	US10B	112.65	052673		
	DBZ	90.15	41981		
	US26	90.15	052804		
	US26D	84.55	52674		
	US28	38.65	052675		
	US32	66.25	063728		
	US32D	40.80	052676		





Description	Finish	2021 List	Stock No.	Box Qty.	Case Qty.
33J					
Pull Plate - Square Corner - 3/4" Round Pull					
Material: Brass, bronze, aluminum, stainless steel					
Gauge: 0.050; CTC: 10"					
Fasteners: #6 x 5/8" OPH tapping screws					
30S x 3J Pull					
3-1/2" x 15"					
	US3	79.25	076230	1	10
	US4	81.60	048521		
	US10	85.00	071881		
	US10B	106.20	006002		
	US26	106.20	113458		
	DBZ	85.00	-		
	US26D	85.00	112480		
	US28	46.70	054673		
	US32	94.00	067662		
	US32D	77.00	065235		
4" x 16"	US3	85.30	087358	1	10
	US4	89.15	080814		
	US10	93.00	059652		
	US10B	116.25	077870		
	DBZ	93.00	-		
	US26	93.00	135368		
	US26D	93.00	092249		
	US28	49.35	060024		
	US32	97.80	068874		
	US32D	79.55	057608		
34G					
Pull Plate - Square Corner - 1" Round Pull					
Material: Brass, bronze, aluminum, stainless steel					
Gauge: 0.050; CTC: 8"					
Fasteners: #6 x 5/8" OPH tapping screws					
30S x 4G Pull					
3-1/2" x 15"					
	US3	93.15	052888	1	10
	US4	100.55	022822		
	US10	104.80	052890		
	US10B	131.00	052891		
	DBZ	104.80	-		
	US26	104.80	068374		
	US26D	104.80	052893		
	US28	52.05	143095		
	US32	106.70	-		
	US32D	90.65	051944		
4" x 16"	US3	96.05	052894	1	10
	US4	102.35	052895		
	US10	107.85	052896		
	US10B	134.80	052897		
	DBZ	107.85	-		
	US26	107.85	052898		
	US26D	107.85	052899		
	US28	53.10	052900		
	US32	108.80	062950		
	US32D	94.00	052901		



1. Items with the price in **bold and red** are Quick Ship items and ship in 24 hours.
Please use stock number when ordering. 2. U/M is each unless otherwise noted.



Trim & Auxiliary



Description	Finish	2021 List	Stock No.	Box Qty.	Case Qty.
34J					
Pull Plate - Square Corner - 1" Round Pull					
Material: Brass, bronze, aluminum, stainless steel					
Gauge: 0.050; CTC: 10"					
Fasteners: #6 x 5/8" OPH tapping screws					
30S x 4J Pull					
3-1/2" x 15"					
	US3	117.15	088937	1	10
	US4	117.15	023595		
	US10	127.15	065332		
	US10B	161.70	057755		
	DBZ	129.35	-		
	US26	122.55	040243		
	US26D	122.55	068488		
	US28	41.45	095443		
	US32	90.65	069479		
	US32D	70.55	059558		
4" x 16"	US3	117.95	058218	1	10
	US4	117.95	076042		
	US10	128.25	054937		
	US10B	166.10	056339		
	DBZ	132.85	-		
	US26	126.20	067490		
	US26D	126.20	063209		
	US28	42.25	065718		
	US32	93.85	074891		
	US32D	71.70	056278		



35D					
Pull Plate - Square Corner - 5/8" Round Pull					
Material: Brass, bronze, aluminum, stainless steel					
Gauge: 0.050; CTC: 5-1/2"					
Fasteners: #6 x 5/8" OPH tapping screws					
30S x 5D Pull					
3-1/2" x 15"					
	US3	60.25	048502		
	US4	60.25	029931		
	US10	64.00	048500		
	US10B	80.00	048503		
	DBZ	64.00	-		
	US26	64.00	057278		
	US26D	64.00	024259		
	US28	29.95	048501		
	US32	61.70	163371		
	US32D	31.85	048505		
4" x 16"	US3	64.00	048508		
	US4	64.00	028846		
	US10	66.05	048506		
	US10B	82.60	048509		
	DBZ	66.05	-		
	US26	66.05	012741		
	US26D	66.05	048510		
	US28	31.15	048507		
	US32	54.00	071154		
	US32D	34.75	048511		





Description	Finish	2021 List	Stock No.	Box Qty.	Case Qty.
35N					
Pull Plate - Square Corner - Cast Pull					
Material: Brass, bronze, aluminum, stainless steel					
Gauge: 0.050; CTC: 5-1/2"					
Fasteners: #6 x 5/8" OPH tapping screws					
30S x 5N Pull					
3-1/2" x 15"					
	US3	63.50	052487	1	10
	US4	64.55	053051		
	US10	68.25	052637		
	US10B	85.30	052488		
	DBZ	68.25	-		
	US26	68.25	052794		
	US26D	68.25	053052		
	US28	40.45	052489		
	US32	93.05	057091		
	US32D	58.40	052490		
4" x 16"	US3	64.90	052639	1	10
	US4	66.60	007485		
	US10	71.85	052795		
	US10B	89.80	052640		
	DBZ	71.85	-		
	US26	71.85	028998		
	US26D	71.85	052641		
	US28	41.30	016004		
	US32	101.85	030733		
	US32D	60.45	052491		



36N					
Pull Plate - Square Corner					
Material: Brass, bronze, aluminum, stainless steel					
Gauge: 0.050; CTC: 5-1/2"					
Fasteners: #6 x 5/8" OPH tapping screws					
30S x 6N Pull					
3-1/2" x 15"					
	US3	59.60	052484	1	10
	US4	59.60	053056		
	US10	62.05	052628		
	US10B	77.55	052629		
	DBZ	62.05	-		
	US26	62.05	052792		
	US26D	62.05	052630		
	US28	32.70	052485		
	US32	82.20	098946		
	US32D	47.40	052631		
4" x 16"	US3	61.65	052632	1	10
	US4	61.65	053050		
	US10	64.10	052633		
	US10B	80.15	052634		
	DBZ	64.10	-		
	US26	64.10	052793		
	US26D	64.10	052635		
	US28	34.75	052636		
	US32	90.05	064685		
	US32D	48.15	052486		

1. Items with the price in **bold and red** are Quick Ship items and ship in 24 hours.
Please use stock number when ordering. 2. U/M is each unless otherwise noted.



Trim & Auxiliary



Description	Finish	2021 List	Stock No.	Box Qty.	Case Qty.
39E					
Pull Plate - Square Corner - 3/4" Oval Pull					
Material: Brass, bronze, aluminum, stainless steel					
Gauge: 0.050; CTC: 6"					
Fasteners: #6 x 5/8" OPH tapping screws					
30S x 9E Pull					
3-1/2" x 15"	US3	59.25	066457	1	10
	US4	59.25	068631		
	US10	61.30	066451		
	US10B	76.60	066452		
	DBZ	61.30	-		
	US26	81.25	066453		
	US26D	67.90	064908		
	US32	72.10	092653		
	US32D	55.60	066454		
4" x 16"	US3	61.30	066242	1	10
	US4	61.30	094002		
	US10	65.40	066459		
	US10B	81.75	066460		
	DBZ	65.40	-		
	US26	85.30	163380		
	US26D	69.95	066286		
	US32	76.20	083352		
	US32D	56.65	066241		



39G					
Pull Plate - Square Corner - 3/4" Oval Pull					
Material: Brass, bronze, aluminum, stainless steel					
Gauge: 0.050; CTC: 8"					
Fasteners: #6 x 5/8" OPH tapping screws					
30S x 9G Pull					
3-1/2" x 15"	US3	61.55	066446	1	10
	US4	61.55	022286		
	US10	66.25	066439		
	US10B	82.80	066440		
	DBZ	66.25	-		
	US26	84.90	125056		
	US26D	70.95	021978		
	US32	77.10	113343		
	US32D	56.65	066442		
4" x 16"	US3	65.65	066448	1	10
	US4	65.65	074705		
	US10	70.70	066449		
	US10B	70.70	066450		
	DBZ	88.40	-		
	US26	89.05	066443		
	US26D	75.05	070325		
	US32	81.20	019174		
	US32D	58.70	066444		





Description	Finish	2021 List	Stock No.	Box Qty.	Case Qty.
39J					
Pull Plate - Square Corner - 3/4" Oval Pull					
Material: Brass, bronze, aluminum, stainless steel	US3	78.65	086925	1	10
Gauge: 0.050; CTC: 10"	US4	95.30	-		
Fasteners: #6 x 5/8" OPH tapping screws	US10	95.30	124357		
30S x 9J Pull	US10B	119.10	039926		
3-1/2" x 15"	DBZ	95.30	-		
	US26	106.30	-		
	US26D	101.35	174973		
	US32	98.45	-		
	US32D	84.70	005157		
4" x 16"	US3	77.50	086628	1	10
	US4	95.85	-		
	US10	95.85	112185		
	US10B	119.80	033458		
	DBZ	95.85	-		
	US26	109.45	106111		
	US26D	106.10	076007		
	US32	99.25	-		
	US32D	86.25	074073		
40R					
Push Plate - Radius Corner - Beveled	US3	23.40	073770	10	50
Material: Brass, bronze, aluminum, stainless steel	US4	24.25	076051		
Gauge: 0.050	US10	28.10	066942		
Fasteners: #6 x 5/8" OPH tapping screws	US10B	35.15	003979		
3" x 12"	DBZ	28.10	-		
	US26	28.10	066131		
	US26D	28.10	074534		
	US28	14.65	043755		
	US32	21.90	152753		
	US32D	18.80	066229		
3-1/2" x 15"	US3	27.00	058476	10	50
	US4	29.95	080655		
	US10	32.40	057093		
	US10B	40.50	025774		
	DBZ	32.40	-		
	US26	32.40	086949		
	US26D	32.40	059230		
	US28	15.75	-		
	US32	25.35	066906		
	US32D	21.90	059562		
4" x 16"	US3	29.75	058347	10	50
	US4	32.85	081497		
	US10	35.40	016005		
	US10B	44.25	060152		
	DBZ	35.40	-		
	US26	35.40	059245		
	US26D	35.40	085378		
	US28	16.55	016006		
	US32	27.30	088231		
	US32D	23.50	052790		



1. Items with the price in **bold and red** are Quick Ship items and ship in 24 hours.
Please use stock number when ordering. 2. U/M is each unless otherwise noted.



Trim & Auxiliary



Description	Finish	2021 List	Stock No.	Box Qty.	Case Qty.
40R (Continued) 6" x 16"	US3	41.55	057640	-	5
	US4	44.70	047040		
	US10	48.55	006018		
	US10B	60.70	072734		
	DBZ	48.55	-		
	US26	48.55	-		
	US26D	48.55	114027		
	US28	21.50	010887		
	US32	51.25	088229		
	US32D	35.80	057637		
8" x 16"	US3	48.75	025145	-	5
	US4	54.25	022787		
	US10	58.50	015792		
	US10B	73.15	061212		
	DBZ	58.50	-		
	US26	58.50	126198		
	US26D	58.50	024628		
	US28	24.45	122600		
	US32	52.05	-		
	US32D	53.35	061211		



A40R					
Push Plate - Radius Corner - Beveled					
Material: Brass, bronze, aluminum, stainless steel					
Gauge: 0.062					
Fasteners: #6 x 5/8" OPH tapping screws					
3" x 12"	US3	34.45	032130	10	50
	US4	34.45	131011		
	US10	39.20	185395		
	US10B	49.00	114771		
	DBZ	39.20	-		
	US26	39.20	039363		
	US26D	39.20	114030		
	US28	23.50	084099		
	US32	34.25	194871		
	US32D	23.95	048868		
3-1/2" x 15"	US3	36.75	191065	10	50
	US4	36.75	049913		
	US10	43.25	181074		
	US10B	54.10	074760		
	DBZ	43.25	-		
	US26	43.25	044606		
	US26D	43.25	038686		
	US28	21.10	-		
	US32	40.45	180893		
	US32D	28.25	059304		
4" x 16"	US3	40.80	029232	10	50
	US4	40.80	014136		
	US10	47.25	140485		
	US10B	59.05	077017		
	DBZ	47.25	-		
	US26	47.25	150804		
	US26D	47.25	015454		
	US28	22.35	047411		
	US32	42.55	135831		
	US32D	30.80	099623		





Description	Finish	2021 List	Stock No.	Box Qty.	Case Qty.
A40R (Continued) 6" x 16"	US3	54.10	45908	-	5
	US4	58.80	-		
	US10	58.80	-		
	US10B	73.50	199329		
	DBZ	58.80	-		
	US26	58.80	-		
	US26D	58.80	055405		
	US28	27.60	-		
	US32	66.60	-		
8" x 16"	US32D	48.35	070607		
	US3	60.15	076399	-	5
	US4	66.00	-		
	US10	67.00	-		
	US10B	83.75	077019		
	DBZ	67.00	-		
	US26	67.00	-		
	US26D	67.00	142995		
	US28	31.05	177968		
	US32	84.35	-		
US32D	51.25	001398			



50T Push Plate - Round - Not Beveled Material: Brass, bronze, aluminum, stainless steel Gauge: 0.050 Fasteners: #6 x 5/8" OPH tapping screws 3" x 12"	US3	28.25	078618	5	50
	US4	28.25	007196		
	US10	30.80	006322		
	US10B	38.50	071333		
	DBZ	30.80	-		
	US26	30.80	-		
	US26D	30.80	102851		
	US28	20.85	102662		
	US32	24.55	-		
	US32D	23.50	059934		
3-1/2" x 15"	US3	29.75	057418	5	50
	US4	29.75	077529		
	US10	35.30	088168		
	US10B	44.10	000846		
	DBZ	35.30	-		
	US26	35.30	075140		
	US26D	35.30	062792		
	US28	23.05	041167		
	US32	28.10	015650		
4" x 16"	US32D	25.80	072371		
	US3	32.85	056970	5	50
	US4	32.85	068950		
	US10	37.75	058204		
	US10B	47.20	075002		
	DBZ	37.75	-		
	US26	37.75	059593		
	US26D	37.75	092668		
	US28	24.55	018465		
US32	27.30	000492			
US32D	30.40	016007			

1. Items with the price in **bold and red** are Quick Ship items and ship in 24 hours.
Please use stock number when ordering. 2. U/M is each unless otherwise noted.



Trim & Auxiliary



Description	Finish	2021 List	Stock No.	Box Qty.	Case Qty.
A50T Push Plate - Round - Beveled Material: Brass, bronze, aluminum, stainless steel Gauge: 0.062 Fasteners: #6 x 5/8" OPH tapping screws 3" x 12"	US3	44.70	094264	5	50
	US4	44.70	107968		
	US10	49.55	074256		
	US10B	61.95	095264		
	DBZ	49.55	-		
	US26	49.55	075708		
	US26D	49.55	079997		
	US28	28.10	097574		
	US32	38.95	189960		
	US32D	33.20	034543		
3-1/2" x 15"	US3	46.45	099962	5	50
	US4	46.45	094532		
	US10	54.50	-		
	US10B	68.10	054241		
	DBZ	54.50	-		
	US26	54.50	014282		
	US26D	54.50	069277		
	US28	32.65	-		
	US32	40.45	-		
	US32D	34.25	084951		
4" x 16"	US3	50.35	084171	5	50
	US4	50.35	075929		
	US10	58.35	130057		
	US10B	72.95	111705		
	DBZ	58.35	-		
	US26	58.35	134570		
	US26D	58.35	032134		
	US28	34.25	039648		
	US32	42.55	053431		
	US32D	37.45	031281		



60S Push Plate - Square Corner - Beveled Material: Plastic Laminate Gauge: 0.125 Fasteners: #6 x 5/8" OPH tapping screws 3" x 12"	PG - Gray	11.05	043566	5	50
	PK - Black	11.05	067121		
	CO - Brown	11.05	035206		
3-1/2" x 15"	PG - Gray	11.90	-	5	50
	PK - Black	11.90	055792		
	CO - Brown	11.90	085523		
4" x 16"	PG - Gray	12.55	072811	5	50
	PK - Black	12.55	056442		
	CO - Brown	12.55	076032		
6" x 16"	PG - Gray	15.75	094770	5	50
	PK - Black	15.75	056581		
	CO - Brown	15.75	076033		
8" x 16"	PG - Gray	18.80	029886	5	50
	PK - Black	18.80	-		
	CO - Brown	18.80	061399		



Description	Finish	2021 List	Stock No.	Box Qty.	Case Qty.
70S					
Push Plate - Square Corner - Beveled					
Material: Clear Plastic Laminate					
Gauge: 0.125					
Fasteners: #6 x 5/8" OPH tapping screws					
3" x 12"	PC - Clear	11.05	057033	5	50
3-1/2" x 15"	PC - Clear	12.50	056757	5	50
6" x 16"	PC - Clear	17.85	058687	5	50
8" x 16"	PC - Clear	20.60	062760	5	50
80S					
Push Plate - Square Corner - Beveled					
Material: Brass, bronze, aluminum, stainless steel					
Gauge: 0.125					
Fasteners: #6 x 5/8" OPH tapping screws					
3" x 12"	US3	50.25	018566	5	50
	US4	53.10	-		
	US10	58.80	110525		
	US10B	73.50	053549		
	US26	58.80	-		
	DBZ	58.80	113461		
	US26D	58.80	064583		
	US28	24.85	147832		
	US32	53.60	142047		
	US32D	41.70	021042		
3-1/2" x 15"	US3	55.65	099583	5	50
	US4	61.00	000935		
	US10	64.75	080441		
	US10B	80.90	064035		
	DBZ	64.75	-		
	US26	64.75	023445		
	US26D	64.75	098464		
	US28	28.70	085960		
	US32	58.60	123564		
	US32D	30.40	066719		
4" x 16"	US3	69.55	069050	5	50
	US4	69.55	053351		
	US10	72.10	070736		
	US10B	90.15	080514		
	DBZ	72.10	038745		
	US26	69.85	003451		
	US26D	69.85	099998		
	US28	30.30	000740		
	US32	60.90	081409		

1. Items with the price in **bold and red** are Quick Ship items and ship in 24 hours.
Please use stock number when ordering. 2. U/M is each unless otherwise noted.



Trim & Auxiliary



Description	Finish	2021 List	Stock No.	Box Qty.	Case Qty.
80S					
Push Plate - Square Corner - Beveled	US3	82.00	125266	-	5
(Continued)	US4	84.30	138751		
6" x 16"	US10	86.95	134181		
	US10B	108.65	057343		
	DBZ	86.95	-		
	US26	86.95	-		
	US26D	86.95	024257		
	US28	44.70	111496		
	US32	77.80	033372		
	US32D	59.85	062560		
8" x 16"	US3	104.10	024903	-	5
	US4	106.10	122088		
	US10	106.10	042324		
	US10B	136.60	041316		
	DBZ	109.30	-		
	US26	109.30	078222		
	US26D	109.30	-		
	US28	54.50	-		
	US32	96.45	021592		
	US32D	74.30	073791		



90R					
Push Plate - Radius Corner - Not Beveled	US3	66.95	154614	5	50
Material: Brass, bronze, aluminum, stainless steel	US4	70.85	013671		
Gauge: 0.125	US10	75.50	-066374		
Fasteners: #6 x 5/8" OPH tapping screws	US10B	94.35	056839		
3" x 12"	DBZ	75.50	-		
	US26	75.50	043374		
	US26D	75.50	097121		
	US28	40.45	026780		
	US32	70.15	-		
	US32D	54.75	099013		
3-1/2" x 15"	US3	72.25	116990	5	50
	US4	74.95	-		
	US10	81.30	140484		
	US10B	101.65	010106		
	DBZ	81.30	-		
	US26	81.30	068575		
	US26D	81.30	032458		
	US28	44.90	078511		
	US32	75.75	-		
	US32D	58.70	068865		
4" x 16"	US3	76.55	086539	5	50
	US4	82.00	002134		
	US10	86.55	077793		
	US10B	108.20	035806		
	DBZ	86.55	-		
	US26	86.55	013904		
	US26D	86.55	084672		
	US28	46.45	089584		
	US32	81.25	164545		
	US32D	59.85	075458		



Description	Finish	2021 List	Stock No.	Box Qty.	Case Qty.
90R					
Push Plate - Radius Corner - Not Beveled					
Material: Brass, bronze, aluminum, stainless steel					
Gauge: 0.125					
Fasteners: #6 x 5/8" OPH tapping screws					
6" x 16"	US3	98.80	092195	-	5
	US4	101.00	165660		
	US10	103.60	-		
	US10B	129.50	087169		
	DBZ	103.60	-		
	US26	103.60	-		
	US26D	103.60	018872		
	US28	61.10	-		
	US32	94.00	-		
	US32D	71.70	080425		
8" x 16"	US3	120.85	-	-	5
	US4	122.85	-		
	US10	125.75	-		
	US10B	157.20	046733		
	DBZ	125.75	-		
	US26	125.75	-		
	US26D	125.75	-		
	US28	70.65	181583		
	US32	112.70	-		
	US32D	85.00	018249		



100T					
Push Plate - Radius Corner - Not Beveled					
Material: Brass, bronze, aluminum, stainless steel					
Gauge: 0.125					
Fasteners: #6 x 5/8" OPH tapping screws					
"3 x 12"	US3	65.40	80351	-	5
	US4	67.55	093144		
	US10	73.55	-		
	US10B	91.95	016836		
	DBZ	73.55	-		
	US26	73.55	051749		
	US26D	73.55	025230		
	US28	39.10	181216		
	US32	68.30	094651		
	US32D	53.20	09486		
3-1/2" x 15"	US3	70.45	069291	-	5
	US4	73.15	040912		
	US10	79.45	068702		
	US10B	99.35	069149		
	DBZ	79.45	-		
	US26	79.45	174234		
	US26D	79.45	007779		
	US28	43.55	121532		
	US32	73.95	071048		
	US32D	57.35	078531		



Trim & Auxiliary



Description	Finish	2021 List	Stock No.	Box Qty.	Case Qty.
100T					
Push Plate - Radius Corner - Not Beveled					
Material: Brass, bronze, aluminum, stainless steel					
Gauge: 0.125					
Fasteners: #6 x 5/8" OPH tapping screws					
4" x 16"	US3	74.85	079375	5	50
	US4	84.70	120436		
	US10	84.70	036191		
	US10B	105.90	069394		
	DBZ	84.70	-		
	US26	84.70	131710		
	US26D	84.70	068881		
	US28	51.60	187514		
	US32	77.85	080612		
	US32D	60.90	071810		
6" x 16"	US3	84.70	79375	-	5
	US4	91.20	120436		
	US10	94.85	36191		
	US10B	118.60	032106		
	DBZ	94.85	-		
	US26	94.85	028999		
	US26D	94.85	146901		
	US28	59.10	138277		
	US32	77.80	159417		
	US32D	69.95	001305		
8" x 16"	US3	112.90	-	-	5
	US4	123.10	-		
	US10	127.80	-		
	US10B	159.80	016853		
	DBZ	127.80	-		
	US26	127.80	-		
	US26D	127.80	146766		
	US28	101.50	-		
	US32	99.70	134422		
	US32D	94.90	012977		

1. Items with the price in **bold and red** are Quick Ship items and ship in 24 hours.
Please use stock number when ordering. 2. U/M is each unless otherwise noted.



Description	Finish	2021 List	Stock No.	Box Qty.	Case Qty.
110S					
Half Circle Push Plate					
8" x 16"	US3	59.80	018809	1	10
Material: Brass, bronze, aluminum, stainless steel	US4	59.80	023148		
Gauge: 0.050	US10B	83.55	017836		
Fasteners: #6 x 5/8" OPH tapping screws	DBZ	66.85	-		
	US26	66.85	018083		
	US26D	66.85	004595		
	US28	38.15	043858		
	US32	57.45	032334		
	US32D	46.70	001030		



120L					
Pull Plate - w/ Lip (Not beveled)	US3	87.55	052718	2	20
3-1/2"x16"	US4	87.55	054479		
Material: Brass, bronze, aluminum, stainless steel	US10	78.80	052719		
Lip Projection: 1-1/8"	US10B	98.50	052720		
Gauge: 0.125	DBZ	78.80	-		
Fasteners: #6 x 5/8" OPH tapping screws	US26	78.80	052837		
	US26D	78.80	052721		
	US28	39.20	052517		
	US32	98.25	016965		
	US32D	42.80	052518		



121L					
Cylinder Pull	US3	51.00	082020	1	10
2" x 3-3/4"	US4	39.20	080813		
Material: Brass, bronze, aluminum, stainless steel	US10	54.10	074977		
Beveled Lip Projection: 1-1/8"	US10B	67.60	073385		
Gauge: 0.125	DBZ	54.10	-		
Cylinder Cutout: 1-1/4" diameter	US26	39.95	020459		
Cylinder sold separately. Stud installed on reverse to prevent twisting.	US26D	54.10	069510		
	US28	35.00	063605		
	US32	46.70	095790		
	US32D	44.30	068962		







122L					
Security Push/Pull Set	US32D	224.15	088047	1	10
Push Plate: 4" x 16"					
Pull Plate: 4" x 9-1/4"					
Fasteners: BTB by Type 6					
Lip Projection: 2-1/8"					
Gauge: 0.125					
Mounting with security torx screws and blank head sex nuts.					

1. Items with the price in **bold and red** are Quick Ship items and ship in 24 hours.
Please use stock number when ordering. 2. U/M is each unless otherwise noted.



Trim & Auxiliary

	Description	Finish	2021 List	Case Qty.	CTC Over 36"
	125S				
	Bent Push Bar	US3	192.50	4	4.00
	Material: Brass, bronze, aluminum, stainless steel	US4	192.50		4.00
	Bar Size: 3/8" x 1-1/4"	US10	199.15		4.00
	Base Plate: 1" x 3"	US10B	248.95		4.00
	Projection: 2-1/8"	DBZ	199.15		
	*Add per linear inch or fraction thereof	US28	119.40		2.75
	Standard fasteners are 1/4"-20 FPHMS and #8 x 3/4" FPH Tapping Screws.	US32	215.60		6.70
		US32D	173.45		5.65
	126S				
	Push Bar				
	Material: Brass, bronze, aluminum, stainless steel				
	Bar Size: 3/8" x 1-1/4"	US3	199.15	4	4.00
	Base Plate: 1" x 3"	US4	249.25		4.00
	Projection: 2-1/8"	US10	295.50		4.00
	*Add per linear inch or fraction thereof	US10B	369.40		4.00
	Standard fasteners are #8 x 3/4" FPH Tapping Screws.	DBZ	295.50		
	Optional thru bolts available.	US28	144.65		2.75
		US32	254.15		6.70
	US32D	224.70		5.65	
	127S				
	Push Bar				
	Material: Brass, bronze, aluminum, stainless steel				
	Bar Size: 3/8" x 1-1/4"	US3	145.90	1	8.00
	Base: 1-1/4" Square	US4	162.00		8.00
	Projection: 3/4"	US10	162.00		8.00
	*Add per linear inch or fraction thereof	US10B	202.50		8.00
	Standard fasteners are 1/4"-20 FPHMS. Optional wood screws available no charge.	DBZ	162.00		
		US28	93.05		5.45
		US32	170.45		12.90
	US32D	131.75		13.40	
	128P				
	Wide Push Bar				
	Material: Brass, bronze, aluminum, stainless steel				
	Bar Size: 3/8" x 3"	US3	347.40	1	8.00
	Base Plate: 1-1/2" x 4-1/2"	US4	371.70		8.00
	Projection: 2-1/8"	US10	382.90		8.00
	*Add per linear inch or fraction thereof	US10	478.65		8.00
	Standard fasteners are #8 x 3/4" FPH Tapping Screws.	DBZ	382.90		
	Optional thru bolts available.	US28	322.85		5.45
		US32	404.65		12.90
	US32D	340.65		13.40	



Description	Finish	2021 List	Case Qty.	CTC Over 36"
128S				
Wide Push Bar	US3	327.10	1	8.00
Material: Brass, bronze, aluminum, stainless steel	US4	341.90		8.00
Bar Size: 3/8" x 3"	US10	358.35		8.00
Base: 3/8" x 3"	US10B	447.90		8.00
Projection: 2"	DBZ	358.35		
Door Thickness: 1-3/4" Standard	US28	178.95		5.45
*Add per linear inch or fraction thereof	US32	379.30		12.90
Standard fasteners are 1/4"-20 x 2-1/4" FPHMS with finish washers.	US32D	316.10		13.40



129P				
Wide Push Bar			1	8.00
Bar Size: 3/8" x 3"	US3	276.95		8.00
Base: 1" x 3"	US4	293.55		8.00
Projection: 3/4"	US10	310.45		8.00
*Add per linear inch or fraction thereof	US10B	388.05		8.00
Standard fasteners are 1/4"-20 x 1-1/4"	DBZ	310.45		
FPHMS. Optional thru bolts available. #14 FPH wood screws available.	US28	128.60		5.45
	US32	342.00		12.90
	US32D	270.90		13.40



130S				
Push Bar			4	4.00
Material: Brass, bronze, aluminum, stainless steel	US3	189.60		4.00
Bar Stock: 1" Round	US4	204.50		4.00
Projection: 2-1/2"	US10	243.75		4.00
Door Thickness: 1-3/4"	US10B	304.70		4.00
*Add per linear inch or fraction thereof	DBZ	243.75		
Standard fasteners are 1/4"-20 x 2-1/4" FPHMS with finish washers. May be ordered with Type 5 mounting at an extra charge.	US28	89.70		2.75
	US32	226.00		6.70
	US32D	178.95		5.65











131S				
Push Bar			4	4.00
Material: Brass, bronze, aluminum, stainless steel	US3	195.30		4.00
Bar Stock: 1" Round	US4	213.80		4.00
Base Plate: 2" Diameter	US10	234.20		4.00
Projection: 2-5/8"	US10B	292.80		4.00
Door Thickness: 1-3/4" Standard	DBZ	234.20		
*Add per linear inch or fraction thereof	US28	97.80		2.75
Standard fasteners are 1/4"-20 x 2-1/4" FPHMS with finish washers. May be ordered with Type 5 mounting at an extra charge.	US32	236.50		6.70
	US32D	193.60		5.65

1. Items with the price in **bold and red** are Quick Ship items and ship in 24 hours.
Please use stock number when ordering. 2. U/M is each unless otherwise noted.



Trim & Auxiliary





	Description	Finish	2021 List	Case Qty.	CTC Over 36"
	133S				
	Push Bar	US3	160.70	4	4.00
	Material: Brass, bronze, aluminum, stainless steel	US4	174.85		4.00
	Bar Stock: 3/4" Round	US10	189.60		4.00
	Projection: 2-1/4"	US10B	237.05		4.00
	Door Thickness: 1-3/4" Standard	DBZ	189.60		
	*Add per linear inch or fraction thereof	US28	76.05		2.75
	Standard fasteners are 1/4"-20 x 2-1/4" FPHMS with finish washers.	US32	193.80		6.70
	US32D	152.15		5.65	
	134S				
	Push Bar	US3	167.15	4	4.00
	Material: Brass, bronze, aluminum, stainless steel	US4	187.80		4.00
	Bar Stock: 3/4" Round	US10	200.70		4.00
	Base Plate: 1-1/4" Diameter	US10B	250.85		4.00
	Projection: 2-3/8"	DBZ	200.70		
	Door Thickness: 1-3/4" Standard	US28	86.85		2.75
	*Add per linear inch or fraction thereof	US32	212.80		6.70
Standard fasteners are 1/4"-20 x 2-1/4" FPHMS with finish washers. May be ordered with Type 5 mounting at an extra charge.	US32D	162.70		5.65	
	136S				
	Push Bar				
	Material: Brass, bronze, aluminum, stainless steel	US3	399.65	4	8.00
	Bar Stock: 1-1/4" Round	US4	408.75		8.00
	Projection: 3"	US10	417.95		8.00
	Fasteners: 5/16" - 18 x 2-1/4" with finish washers	US10B	522.45		8.00
	Door Thickness: 1-3/4" Standard	DBZ	417.95		
	*Add per linear inch or fraction thereof	US28	289.05		5.45
May be ordered with Type 5 mounting at an extra charge.	US32	379.30		12.90	
	US32D	343.20		13.40	
	137S				
	Push Bar				
	Material: Brass, bronze, aluminum, stainless steel	US3	409.10	4	8.00
	Bar Stock: 1-1/4" Round	US4	417.95		8.00
	Base Plate: 2" Diameter	US10	427.45		8.00
	Projection: 3-1/8"	US10B	534.30		8.00
	Door Thickness: 1-3/4" Standard	DBZ	427.45		
	Fasteners: 5/16" - 18 x 2-1/4" with finish washers	US28	298.10		5.45
Additional bars by quotation	US32	431.70		12.90	
*Add per linear inch or fraction thereof	US32D	352.20		13.40	
May be ordered with Type 5 mounting at an extra charge.					

	Description	Finish	2021 List	Case Qty.	CTC Over 36"
	138P				
	Push/Pull Set	US3	423.45	2	16.10
	Material: Brass, bronze, aluminum, stainless steel	US4	460.70		16.10
	Bar Stock: 1" Round	US10	490.25		16.10
	Projection: 2-1/2"	US10B	612.80		16.10
	Fasteners: 1/4" - 20 type 3 concealed cone	DBZ	490.25		
	*Add per linear inch or fraction thereof	US28	222.25		10.70
	US32	494.90		23.65	
	US32D	400.95		26.80	
	139P				
	Push/Pull Set	US3	365.55	2	16.10
	Material: Brass, bronze, aluminum, stainless steel	US4	393.90		16.10
	Bar Stock: 3/4" Round	US10	423.45		16.10
	Projection: 2-1/4"	US10B	529.30		16.10
	Fasteners: 1/4" - 20 type 3 concealed cone	DBZ	423.45		
	*Add per linear inch or fraction thereof	US28	195.15		10.70
	US32	429.70		23.65	
	US32D	347.40		26.80	
	140P				
	Push/Pull Set				
	Material: Brass, bronze, aluminum, stainless steel				
	Bar Stock: 1-1/4" Round	US3	845.20	2	16.10
	Projection: 3"	US4	861.65		16.10
	Fasteners: 5-16" - 18 Type 3 concealed cone	US10	880.20		16.10
	*Add per linear inch or fraction thereof	US10B	1,100.25		16.10
	DBZ	880.20			
	US28	639.10		10.70	
	US32	837.80		23.65	
	US32D	729.50		26.80	
	150B				
	Push/Pull Set				
	Material: Brass, bronze, aluminum, stainless steel				
	Bar Stock: 3/4" Round	US3	291.75	2	4.00
	Projection: 2-1/4"	US4	304.90		4.00
	CTC: 8"	US10	314.00		4.00
	Fasteners: Type 7 & (2) Type 8	US10B	392.50		4.00
Additional bars by quotation	DBZ	314.00			
*Add per linear inch or fraction thereof	US28	164.85		2.75	
For tempered glass only	US32	359.40		6.70	
	US32D	287.20		5.65	





1. Items with the price in **bold and red** are Quick Ship items and ship in 24 hours.
Please use stock number when ordering. 2. U/M is each unless otherwise noted.



Trim & Auxiliary

	Description	Finish	2021 List	Case Qty.	CTC Over 36"
	150D				
	Push/Pull Set	US3	245.80	2	4.00
	Material: Brass, bronze, aluminum, stainless steel	US4	258.40		4.00
	Bar Stock: 3/4" Round	US10	267.55		4.00
	Projection: 2-1/4"	US10B	334.45		4.00
	CTC: 8"	DBZ	267.55		
	Fasteners: Type 7 & (2) Type 1	US28	128.45		2.75
	Additional bars by quotation	US32	314.35		6.70
	*Add per linear inch or fraction thereof	US32D	242.10		5.65
	Standard fastening method				
	150V				
	Push/Pull Set				
	Material: Brass, bronze, aluminum, stainless steel				
	Bar Stock: 3/4" Round				
	Projection: 2-1/4"	US3	275.55	2	4.00
	CTC: 8"	US4	288.15		4.00
	Fasteners: Type 7 & (2) Type 5	US10	297.25		4.00
	Additional bars by quotation	US10B	371.55		4.00
	*Add per linear inch or fraction thereof	DBZ	297.25		
	Fully concealed fastening method	US28	157.35		2.75
	US32	343.20		6.70	
	US32D	270.90		5.65	
	151B				
	Push/Pull Set				
	Material: Brass, bronze, aluminum, stainless steel				
	Bar Stock: 3/4" Round	US3	304.90	2	4.00
	Projection: 2-1/4"	US4	317.70		4.00
	CTC: 10"	US10	329.50		4.00
	Fasteners: Type 7 & (2) Type 8	US10B	411.85		4.00
	Additional bars by quotation	DBZ	329.50		
	*Add per linear inch or fraction thereof	US28	182.90		2.75
	For tempered glass only	US32	326.90		6.70
	US32D	298.10		5.65	
	151D				
	Push/Pull Set				
	Material: Brass, bronze, aluminum, stainless steel	US3	258.40	2	4.00
	Bar Stock: 3/4" Round	US4	271.50		4.00
	Projection: 2-1/4"	US10	283.10		4.00
	CTC: 10"	US10B	353.85		4.00
	Fasteners: Type 7 & (2) Type 1	DBZ	283.10		
	Additional bars by quotation	US28	139.40		2.75
	*Add per linear inch or fraction thereof	US32	325.10		6.70
	Standard fastening method	US32D	252.95		5.65







	Description	Finish	2021 List	Case Qty.	CTC Over 36"*
	151V				
	Push/Pull Set	US3	288.15	2	4.00
	Material: Brass, bronze, aluminum, stainless steel	US4	300.95		4.00
	Bar Stock: 3/4" Round	US10	312.80		4.00
	Projection: 2-1/4"	US10B	391.00		4.00
	CTC: 10"	DBZ	312.80		
	Fasteners: Type 7 & (2) Type 5	US28	171.15		2.75
	Additional bars by quotation	US32	354.00		6.70
	*Add per linear inch or fraction thereof	US32D	281.75		5.65
	Fully concealed fastening method				
	152B				
	Push/Pull Set				
	Material: Brass, bronze, aluminum, stainless steel				
	Bar Stock: 3/4" Round	US3	318.35	2	4.00
	Projection: 2-1/4"	US4	340.00		4.00
	CTC: 12"	US10	343.75		4.00
	Fasteners: Type 7 & (2) Type 8	US10B	429.70		4.00
	Additional bars by quotation	DBZ	343.75		
	*Add per linear inch or fraction thereof	US28	193.50		2.75
	For tempered glass only	US32	376.05		6.70
	US32D	308.95		5.65	
	152D				
	Push/Pull Set				
	Material: Brass, bronze, aluminum, stainless steel				
	Bar Stock: 3/4" Round	US3	271.75	2	4.00
	Projection: 2-1/4"	US4	293.55		4.00
	CTC: 12"	US10	297.25		4.00
	Fasteners: Type 7 & (2) Type 1	US10B	371.55		4.00
	Additional bars by quotation	DBZ	297.25		
	*Add per linear inch or fraction thereof Standard fastening method	US28	153.20		2.75
		US32	331.00		6.70
	US32D	263.95		5.65	
	152V				
	Push/Pull Set				
	Material: Brass, bronze, aluminum, stainless steel	US3	301.40	2	4.00
	Bar Stock: 3/4" Round	US4	323.25		4.00
	Projection: 2-1/4"	US10	327.10		4.00
	CTC: 12"	US10B	408.85		4.00
	Fasteners: Type 7 & (2) Type 5	DBZ	327.10		
	Additional bars by quotation	US28	184.95		2.75
	*Add per linear inch or fraction thereof	US32	360.00		6.70
	Fully concealed fastening method	US32D	292.65		5.65

1. Items with the price in **bold and red** are Quick Ship items and ship in 24 hours.
Please use stock number when ordering. 2. U/M is each unless otherwise noted.



Trim & Auxiliary

	Description	Finish	2021 List	Case Qty.	CTC Over 36"
	153B				
	Push/Pull Set	US3	326.55	2	4.00
	Material: Brass, bronze, aluminum, stainless steel	US4	365.90		4.00
	Bar Stock: 1" Round	US10	365.90		4.00
	Projection: 2-1/2"	US10B	457.40		4.00
	CTC: 10"	DBZ	365.90		
	Fasteners: Type 7 & (2) Type 8	US28	186.00		2.75
	Additional bars by quotation	US32	380.05		6.70
*Add per linear inch or fraction thereof	US32D	308.60		5.65	
For tempered glass only					
	153D				
	Push/Pull Set	US3	280.25	2	4.00
	Material: Brass, bronze, aluminum, stainless steel	US4	319.50		4.00
	Bar Stock: 1" Round	US10	333.05		4.00
	Projection: 2-1/2"	US10B	419.60		4.00
	CTC: 10"	DBZ	335.70		
	Fasteners: Type 7 & (2) Type 1	US28	140.95		2.75
	Additional bars by quotation	US32	334.95		6.70
*Add per linear inch or fraction thereof	US32D	263.40		5.65	
Standard fastening method					
	153V				
	Push/Pull Set	US3	310.45	2	4.00
	Material: Brass, bronze, aluminum, stainless steel	US4	349.25		4.00
	Bar Stock: 1" Round	US10	349.25		4.00
	Projection: 2-1/2"	US10B	436.60		4.00
	CTC: 10"	DBZ	349.25		
	Fasteners: Type 7 & (2) Type 5	US28	171.85		2.75
	Additional bars by quotation	US32	363.85		6.70
*Add per linear inch or fraction thereof	US32D	292.25		5.65	
Fully concealed fastening method					
	154B				
	Push/Pull Set	US3	337.65	2	4.00
	Material: Brass, bronze, aluminum, stainless steel	US4	383.00		4.00
	Bar Stock: 1" Round	US10	391.55		4.00
	Projection: 2-1/2"	US10B	489.45		4.00
	CTC: 12"	DBZ	391.55		
	Fasteners: Type 7 & (2) Type 8	US28	213.20		2.75
	Additional bars by quotation	US32	393.15		6.70
*Add per linear inch or fraction thereof	US32D	318.05		5.65	
For tempered glass only					



Description	Finish	2021 List	Case Qty.	CTC Over 36"*
154D				
Push/Pull Set	US3	289.70	2	4.00
Material: Brass, bronze, aluminum, stainless steel	US4	330.15		4.00
Bar Stock: 1" Round	US10	346.70		4.00
Projection: 2-1/2"	US10B	433.35		4.00
CTC: 12"	DBZ	346.70		
Fasteners: Type 7 & (2) Type 1	US28	157.35		2.75
Additional bars by quotation	US32	348.05		6.70
*Add per linear inch or fraction thereof	US32D	272.85		5.65
Standard fastening method				



154V				
Push/Pull Set				
Material: Brass, bronze, aluminum, stainless steel				
Bar Stock: 1" Round	US3	319.40	2	4.00
Projection: 2-1/2"	US4	359.85		4.00
CTC: 12"	US10	375.75		4.00
Fasteners: Type 7 & (2) Type 5	US10B	469.70		4.00
Additional bars by quotation	DBZ	375.75		
*Add per linear inch or fraction thereof	US28	194.65		2.75
Fully concealed fastening method	US32	377.05		6.70
	US32D	301.70		5.65



155B				
Push/Pull Set				
Material: Brass, bronze, aluminum, stainless steel				
Bar Stock: 1" Round	US3	376.05	2	4.00
Projection: 2-1/2"	US4	399.50		4.00
CTC: 18"	US10	422.90		4.00
Fasteners: Type 7 & (2) Type 8	US10B	528.65		4.00
Additional bars by quotation	DBZ	422.90		
*Add per linear inch or fraction thereof	US28	243.30		2.75
For tempered glass only	US32	427.30		6.70
	US32D	345.00		5.65







155D				
Push/Pull Set				
Material: Brass, bronze, aluminum, stainless steel	US3	329.65	2	4.00
Bar Stock: 1" Round	US4	372.15		4.00
Projection: 2-1/2"	US10	376.60		4.00
CTC: 18"	US10B	470.75		4.00
Fasteners: Type 7 & (2) Type 1	DBZ	376.60		
Additional bars by quotation	US28	167.25		2.75
*Add per linear inch or fraction thereof	US32	382.15		6.70
Standard fastening method	US32D	299.90		5.65

1. Items with the price in **bold and red** are Quick Ship items and ship in 24 hours. Please use stock number when ordering. 2. U/M is each unless otherwise noted.



Trim & Auxiliary

	Description	Finish	2021 List	Case Qty.	CTC Over 36"
	155V				
	Push/Pull Set	US3	359.30	2	4.00
	Material: Brass, bronze, aluminum, stainless steel	US4	382.90		4.00
	Bar Stock: 1" Round	US10	406.15		4.00
	Projection: 2-1/2"	US10B	507.65		4.00
	CTC: 18"	DBZ	406.15		
	Fasteners: Type 7 & (2) Type 5	US28	205.30		2.75
	Additional bars by quotation	US32	410.95		6.70
	*Add per linear inch or fraction thereof	US32D	328.90		5.65
	Fully concealed fastening method				
	156B				
	Offset Push/Pull Set			1	4.00
	Material: Brass, bronze, aluminum, stainless steel	US3	336.30		4.00
	Bar Stock: 3/4" Round	US4	336.30		4.00
	Projection: 2-1/2"	US10	351.60		4.00
	Offset: 2-1/2"	US10B	439.50		4.00
	CTC: 8"	DBZ	351.60		
	Fasteners: Type 7 & (2) Type 8	US28	215.15		2.75
	Handing Required	US32	399.75		6.70
	Additional bars by quotation	US32D	318.15		5.65
*Add per linear inch or fraction thereof					
For tempered glass only					
	156D				
	Offset Push/Pull Set			1	4.00
	Material: Brass, bronze, aluminum, stainless steel	US3	278.75		4.00
	Bar Stock: 3/4" Round	US4	289.80		4.00
	Projection: 2-1/2"	US10	305.10		4.00
	Offset: 2-1/2"	US10B	381.35		4.00
	CTC: 8"	DBZ	305.10		
	Fasteners: Type 7 & (2) Type 1	US28	170.00		2.75
	Handing Required	US32	354.75		6.70
	Additional bars by quotation	US32D	273.00		5.65
*Add per linear inch or fraction thereof					
Standard fastening method					
	156V				
	Offset Push/Pull Set			1	4.00
	Material: Brass, bronze, aluminum, stainless steel	US3	309.00		4.00
	Bar Stock: 3/4" Round	US4	319.50		4.00
	Projection: 2-1/2"	US10	334.85		4.00
	Offset: 2-1/2"	US10B	418.55		4.00
	CTC: 8"	DBZ	334.85		
	Fasteners: Type 7 & (2) Type 5	US28	198.90		2.75
	Handing Required	US32	383.45		6.70
	Additional bars by quotation	US32D	301.90		5.65
*Add per linear inch or fraction thereof					
Fully concealed fastening method					





Description	Finish	2021 List	Case Qty.	CTC Over 36"*
157B				
Offset Push/Pull Set	US3	342.70	1	4.00
Material: Brass, bronze, aluminum, stainless steel	US4	351.90		4.00
Bar Stock: 3/4" Round	US10	367.80		4.00
Projection: 2-1/2"	US10B	459.75		4.00
Offset: 2-1/2"	DBZ	367.80		
CTC: 10"	US28	219.35		2.75
Fasteners: Type 7 & (2) Type 8	US32	410.35		6.70
Handing Required	US32D	325.60		5.65
Additional bars by quotation				
*Add per linear inch or fraction thereof				
For tempered glass only				



157D				
Offset Push/Pull Set			1	4.00
Material: Brass, bronze, aluminum, stainless steel				
Bar Stock: 3/4" Round	US3	286.65		4.00
Projection: 2-1/2"	US4	297.25		4.00
Offset: 2-1/2"	US10	313.15		4.00
CTC: 10"	US10B	391.45		4.00
Fasteners: Type 7 & (2) Type 1	DBZ	313.15		
Handing Required	US28	174.35		2.75
Additional bars by quotation	US32	365.35		6.70
*Add per linear inch or fraction thereof	US32D	280.50		5.65
Standard fastening method				



157V				
Offset Push/Pull Set			1	4.00
Material: Brass, bronze, aluminum, stainless steel				
Bar Stock: 3/4" Round	US3	316.95		4.00
Projection: 2-1/2"	US4	327.10		4.00
Offset: 2-1/2"	US10	343.05		4.00
CTC: 10"	US10B	428.80		4.00
Fasteners: Type 7 & (2) Type 5	DBZ	343.05		
Handing Required	US28	203.30		2.75
Additional bars by quotation	US32	394.35		6.70
*Add per linear inch or fraction thereof	US32D	309.25		5.65
Fully concealed fastening method				





158B				
Offset Push/Pull Set	US3	347.10	1	4.00
Material: Brass, bronze, aluminum, stainless steel	US4	372.60		4.00
Bar Stock: 3/4" Round	US10	388.55		4.00
Projection: 2-1/2"	US10B	485.70		4.00
Offset: 2-1/2"	DBZ	388.55		
CTC: 12"	US28	238.45		2.75
Fasteners: Type 7 & (2) Type 8	US32	429.90		6.70
Handing Required	US32D	339.65		5.65
Additional bars by quotation				
*Add per linear inch or fraction thereof				
For tempered glass only				

1. Items with the price in **bold and red** are Quick Ship items and ship in 24 hours.
Please use stock number when ordering. 2. U/M is each unless otherwise noted.



Trim & Auxiliary

	Description	Finish	2021 List	Case Qty.	CTC Over 36"
	158D				
	Offset Push/Pull Set	US3	317.90	1	4.00
	Material: Brass, bronze, aluminum, stainless steel	US4	317.70		4.00
	Bar Stock: 3/4" Round	US10	329.30		4.00
	Projection: 2-1/2"	US10B	411.60		4.00
	Offset: 2-1/2"	DBZ	329.30		
	CTC: 12"	US28	193.50		2.75
	Fasteners: Type 7 & (2) Type 1	US32	384.65		6.70
	Handing Required	US32D	294.50		5.65
	Additional bars by quotation *Add per linear inch or fraction thereof Standard fastening method				
	158V				
	Offset Push/Pull Set	US3	330.55	1	4.00
	Material: Brass, bronze, aluminum, stainless steel	US4	347.40		4.00
	Bar Stock: 3/4" Round	US10	359.05		4.00
	Projection: 2-1/2"	US10B	448.80		4.00
	Offset: 2-1/2"	DBZ	359.05		
	CTC: 12"	US28	222.25		2.75
	Fasteners: Type 7 & (2) Type 5	US32	413.60		6.70
	Handing Required	US32D	323.35		5.65
	Additional bars by quotation *Add per linear inch or fraction thereof Fully concealed fastening method				
	159B				
	Offset Push/Pull Set				
	Material: Brass, bronze, aluminum, stainless steel				
	Bar Stock: 1" Round	US3	369.70	1	4.00
	Projection: 2-1/2"	US4	399.50		4.00
	Offset: 3"	US10	414.25		4.00
	CTC: 10"	US10B	517.85		4.00
	Fasteners: Type 7 & (2) Type 8	DBZ	414.25		
	Handing Required	US28	224.15		2.75
	Additional bars by quotation *Add per linear inch or fraction thereof For tempered glass only	US32	406.30		6.70
US32D	346.35		5.65		
	159D				
	Offset Push/Pull Set				
	Material: Brass, bronze, aluminum, stainless steel	US3	323.25	1	4.00
	Bar Stock: 1" Round	US4	353.05		4.00
	Projection: 2-1/2"	US10	392.50		4.00
	Offset: 3"	US10B	490.60		4.00
	CTC: 10"	DBZ	392.50		
	Fasteners: Type 7 & (2) Type 1	US28	171.95		2.75
	Handing Required	US32	361.40		6.70
	Additional bars by quotation *Add per linear inch or fraction thereof Standard fastening method	US32D	301.15		5.65







	Description	Finish	2021 List	Case Qty.	CTC Over 36"
	159V				
	Offset Push/Pull Set	US3	353.05	1	4.00
	Material: Brass, bronze, aluminum, stainless steel	US4	382.90		4.00
	Bar Stock: 1" Round	US10	397.70		4.00
	Projection: 2-1/2"	US10B	497.10		4.00
	Offset: 3"	DBZ	397.70		
	CTC: 10"	US28	206.05		2.75
	Fasteners: Type 7 & (2) Type 5	US32	390.15		6.70
	Handing Required	US32D	330.05		5.65
	Additional bars by quotation				
*Add per linear inch or fraction thereof					
Fully concealed fastening method					
	160B				
	Offset Push/Pull Set	US3	378.65	1	4.00
	Material: Brass, bronze, aluminum, stainless steel	US4	406.90		4.00
	Bar Stock: 1" Round	US10	421.80		4.00
	Projection: 2-1/2"	US10B	527.25		4.00
	Offset: 3"	DBZ	421.80		
	CTC: 12"	US28	242.10		2.75
	Fasteners: Type 7 & (2) Type 8	US32	424.40		6.70
	Handing Required	US32D	352.20		5.65
	Additional bars by quotation				
*Add per linear inch or fraction thereof					
For tempered glass only					
	160D				
	Offset Push/Pull Set	US3	332.30	1	4.00
	Material: Brass, bronze, aluminum, stainless steel	US4	360.55		4.00
	Bar Stock: 1" Round	US10	395.75		4.00
	Projection: 2-1/2"	US10B	499.05		4.00
	Offset: 3"	DBZ	399.25		
	CTC: 12"	US28	178.95		2.75
	Fasteners: Type 7 & (2) Type 1	US32	379.30		6.70
	Handing Required	US32D	307.20		5.65
	Additional bars by quotation				
*Add per linear inch or fraction thereof					
Standard fastening method					
	160V				
	Offset Push/Pull Set	US3	361.85	1	4.00
	Material: Brass, bronze, aluminum, stainless steel	US4	390.15		4.00
	Bar Stock: 1" Round	US10	404.40		4.00
	Projection: 2-1/2"	US10B	506.30		4.00
	Offset: 3"	DBZ	405.05		
	CTC: 12"	US28	216.95		2.75
	Fasteners: Type 7 & (2) Type 5	US32	408.25		6.70
	Handing Required	US32D	336.00		5.65
	Additional bars by quotation				
*Add per linear inch or fraction thereof					
Fully concealed fastening method					

1. Items with the price in **bold and red** are Quick Ship items and ship in 24 hours.
Please use stock number when ordering. 2. U/M is each unless otherwise noted.



Trim & Auxiliary

	Description	Finish	2021 List	Case Qty.	CTC Over 36"
	161B				
	Offset Push/Pull Set	US3	375.20	1	4.00
	Material: Brass, bronze, aluminum, stainless steel	US4	407.05		4.00
	Bar Stock: 1" Round	US10	433.40		4.00
	Projection: 2-1/2"	US10B	541.80		4.00
	Offset: 3"	DBZ	433.40		
	CTC: 18"	US28	240.95		2.75
	Fasteners: Type 7 & (2) Type 8	US32	438.65		6.70
	Handing Required	US32D	352.65		5.65
	Additional bars by quotation				
	*Add per linear inch or fraction thereof				
	For tempered glass only				
	161D				
	Offset Push/Pull Set	US3	351.10	1	4.00
	Material: Brass, bronze, aluminum, stainless steel	US4	380.90		4.00
	Bar Stock: 1" Round	US10	408.75		4.00
	Projection: 2-1/2"	US10B	510.95		4.00
	Offset: 3"	DBZ	408.75		
	CTC: 18"	US28	195.55		2.75
	Fasteners: Type 7 & (2) Type 1	US32	415.50		6.70
	Handing Required	US32D	332.85		5.65
	Additional bars by quotation				
	*Add per linear inch or fraction thereof				
	Standard fastening method				
	161V				
	Offset Push/Pull Set	US3	377.20	1	4.00
	Material: Brass, bronze, aluminum, stainless steel	US4	410.60		4.00
	Bar Stock: 1" Round	US10	438.50		4.00
	Projection: 2-1/2"	US10B	548.15		4.00
	Offset: 3"	DBZ	438.50		
	CTC: 18"	US28	314.35		2.75
	Fasteners: Type 7 & (2) Type 5	US32	444.30		6.70
	Handing Required	US32D	354.00		5.65
	Additional bars by quotation				
	*Add per linear inch or fraction thereof				
	Fully concealed fastening method				
	164B				
	Push/Pull Set	US3	667.00	1	8.00
	Material: Brass, bronze, aluminum, stainless steel	US4	694.05		8.00
	Bar Stock: 1-1/4" Round	US10	707.15		8.00
	Projection: 3"	US10B	883.95		8.00
	CTC: 12"	DBZ	707.15		
	Fasteners: Type 7 & (2) Type 8	US28	525.45		5.45
	Additional bars by quotation	US32	703.05		12.90
	*Add per linear inch or fraction thereof	US32D	580.10		13.40
	For tempered glass only				



Description	Finish	2021 List	Case Qty.	CTC Over 36"
164D				
Push/Pull Set	US3	606.70	1	8.00
Material: Brass, bronze, aluminum, stainless steel	US4	646.80		8.00
Bar Stock: 1-1/4" Round	US10	646.80		8.00
Projection: 3"	US10B	808.50		8.00
CTC: 12"	DBZ	646.80		
Fasteners: Type 7 & (2) Type 1	US28	466.80		5.45
Additional bars by quotation	US32	580.10		12.90
*Add per linear inch or fraction thereof	US32D	521.45		13.40
Standard fastening method				



164V				
Push/Pull Set			1	8.00
Material: Brass, bronze, aluminum, stainless steel	US3	686.90		8.00
Bar Stock: 1-1/4" Round	US4	686.90		8.00
Projection: 3"	US10	701.05		8.00
CTC: 12"	US10B	876.35		8.00
Fasteners: Type 7 & (2) Type 5	DBZ	701.05		
Additional bars by quotation	US28	505.85		5.45
*Add per linear inch or fraction thereof	US32	632.80		12.90
Fully concealed fastening method	US32D	566.45		13.40



165B				
Push/Pull Set			1	8.00
Material: Brass, bronze, aluminum, stainless steel				
Bar Stock: 1-1/4" Round				
Projection: 3"	US3	707.15		8.00
CTC: 18"	US4	747.15		8.00
Fasteners: Type 7 & (2) Type 8	US10	747.15		8.00
Additional bars by quotation	US10B	933.95		8.00
*Add per linear inch or fraction thereof	DBZ	747.15		
For tempered glass only	US28	546.90		5.45
	US32	667.90		12.90
	US32D	615.20		13.40







165D				
Push/Pull Set			1	8.00
Material: Brass, bronze, aluminum, stainless steel	US3	646.80		8.00
Bar Stock: 1-1/4" Round	US4	686.90		8.00
Projection: 3"	US10	686.90		8.00
CTC: 18"	US10B	858.65		8.00
Fasteners: Type 7 & (2) Type 1	DBZ	686.90		
Additional bars by quotation	US28	488.30		5.45
*Add per linear inch or fraction thereof	US32	609.35		12.90
Standard fastening method	US32D	550.70		13.40

1. Items with the price in **bold and red** are Quick Ship items and ship in 24 hours.
Please use stock number when ordering. 2. U/M is each unless otherwise noted.



Trim & Auxiliary

	Description	Finish	2021 List	Case Qty.	CTC Over 36"
	165V				
	Push/Pull Set	US3	718.85	1	8.00
	Material: Brass, bronze, aluminum, stainless steel	US4	727.15		8.00
	Bar Stock: 1-1/4" Round	US10	727.15		8.00
	Projection: 3"	US10B	908.90		8.00
	CTC: 18"	DBZ	727.15		
	Fasteners: Type 7 & (2) Type 5	US28	527.30		5.45
	Additional bars by quotation	US32	662.00		12.90
	*Add per linear inch or fraction thereof	US32D	605.45		13.40
	Fully concealed fastening method				
	167B				
	Offset Push/Pull Set	US3	783.30	1	8.00
	Material: Brass, bronze, aluminum, stainless steel	US4	801.35		8.00
	Bar Stock: 1-1/4" Round	US10	823.55		8.00
	Projection: 3"	US10B	1,029.40		8.00
	Offset: 3-3/4"	DBZ	823.55		
	CTC: 18"	US28	586.00		5.45
	Fasteners: Type 7 & (2) Type 8	US32	740.20		12.90
	Handing Required	US32D	654.10		13.40
	Additional bars by quotation				
*Add per linear inch or fraction thereof					
For tempered glass only					
	167D				
	Offset Push/Pull Set				
	Material: Brass, bronze, aluminum, stainless steel	US3	748.00	1	8.00
	Bar Stock: 1-1/4" Round	US4	748.00		8.00
	Projection: 3"	US10	787.45		8.00
	Offset: 3-3/4"	US10B	984.30		8.00
	CTC: 18"	DBZ	787.45		
	Fasteners: Type 7 & (2) Type 1	US28	527.30		5.45
	Handing Required	US32	681.55		12.90
	Additional bars by quotation	US32D	589.85		13.40
*Add per linear inch or fraction thereof					
Standard fastening method					
	167V				
	Offset Push/Pull Set				
	Material: Brass, bronze, aluminum, stainless steel	US3	751.35	1	8.00
	Bar Stock: 1-1/4" Round	US4	765.70		8.00
	Projection: 3"	US10	765.70		8.00
	Offset: 3-3/4"	US10B	957.15		8.00
	CTC: 18"	DBZ	765.70		
	Fasteners: Type 7 & (2) Type 5	US28	550.60		5.45
	Handing Required	US32	701.55		12.90
	Additional bars by quotation	US32D	628.70		13.40
*Add per linear inch or fraction thereof					
Fully concealed fastening method					



Description	Finish	2021 List	Case Qty.	CTC Over 36"
170D				
Push/Pull Set	US3	1,027.30	1	32.10
Material: Brass, bronze, aluminum, stainless steel	US4	1,027.30		32.10
Bar Stock: 3/8" x 1-1/4"	US10	1,027.30		32.10
Base: 1-1/4" Square	US10B	1,284.15		32.10
Projection: Push Bar 3/4"	DBZ	1,027.30		
Projection: Pull Bar 2-1/2"	US28	546.90		21.50
Fasteners: 1/4" 20 thru bolts Type 4	US32	998.85		51.50
*Add per linear inch or fraction thereof	US32D	910.95		53.60

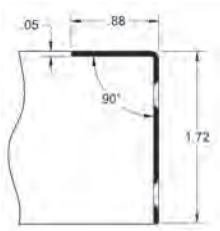

Description	Finish	2021 List	Case Qty.
180H			
Door Edgings - Mortise Type	≤42"	US28 41.30	10
Material: Aluminum, stainless steel		US32D 58.50	
Thickness: .045 - .050"	>42" - 96"	US28 82.60	10
Fasteners: #6 x 5/8" FPHSMS (Self drilling) #6 x 1" screws available on request.		US32D 117.00	
Standard edge guards made for 1-3/4" +0/-1/32" door thickness. Please provide actual door thickness.			
Cutouts will hand product, specify handling. Other lengths by quotation.			
Hinge Cutout (Add to list price) Per Cutout	US28	28.20	
	US32D	28.20	
Bolt Cutout (Add to list price) Per Cutout	US28	28.25	
	US32D	28.25	
Latch Cutout (Add to list price) Per Cutout	US28	28.20	
	US32D	28.20	
UL Rated (Add to list price) Per Cutout	US32D	17.05	

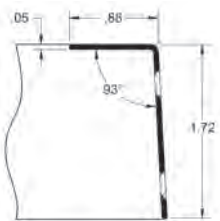

180K			
Door Edgings - Mortise Type	≤42"	US28 42.45	10
Material: Aluminum, stainless steel		US32D 66.20	
Thickness: .045 - .050"	>42" - 96"	US28 84.85	10
Fasteners: #6 x 5/8" FPHSMS (Self drilling) #6 x 1" screws available on request.		US32D 132.35	
Standard edge guards made for 1-3/4" +0/-1/32" door thickness. Please provide actual door thickness.			
Cutouts will hand product, specify handling. Other lengths by quotation.			
Hinge Cutout (Add to list price) Per Cutout	US28	28.20	
	US32D	28.20	
Bolt Cutout (Add to list price) Per Cutout	US28	28.25	
	US32D	28.25	
Latch Cutout (Add to list price) Per Cutout	US28	28.20	
	US32D	28.20	
UL Rated (Add to list price) Per Cutout	US32D	17.05	

1. Items with the price in **bold and red** are Quick Ship items and ship in 24 hours. Please use stock number when ordering. 2. U/M is each unless otherwise noted.



Trim & Auxiliary

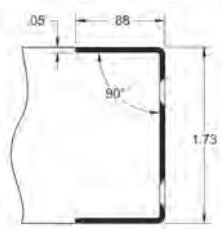

Description	Finish	2021 List	Case Qty.
180M			
Door Edgings - Mortise Type	≤42"	US28 66.20	10
Material: Aluminum, stainless steel	US32D	87.15	
Thickness: .045 - .050"	>42" - 96"	US28 132.35	10
Fasteners: #6 x 5/8" FPHSMS (Self drilling) #6 x 1" screws available on request.	US32D	174.30	
Standard edge guards made for 1-3/4" +0/-1/32" door thickness. Please provide actual door thickness. Cutouts will hand product, specify handling. Other lengths by quotation.			
Hinge Cutout (Add to list price) Per Cutout	US28	28.20	
	US32D	28.20	
Bolt Cutout (Add to list price) Per Cutout	US28	28.25	
	US32D	28.25	
Latch Cutout (Add to list price) Per Cutout	US28	28.20	
	US32D	28.20	
UL Rated (Add to list price) Per Cutout	US32D	17.05	

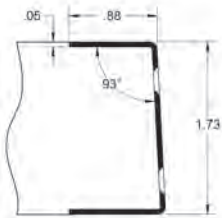

180P			
Door Edgings - Mortise Type	≤42"	US28 70.65	10
Material: Aluminum, stainless steel	US32D	92.15	
Thickness: .045 - .050"	>42" - 96"	US28 141.30	
Fasteners: #6 x 5/8" FPHSMS (Self drilling) #6 x 1" screws available on request.	US32D	184.25	
Standard edge guards made for 1-3/4" +0/-1/32" door thickness. Please provide actual door thickness. Cutouts will hand product, specify handling. Other lengths by quotation.			
Hinge Cutout (Add to list price) Per Cutout	US28	28.20	
	US32D	28.20	
Bolt Cutout (Add to list price) Per Cutout	US28	28.25	
	US32D	28.25	
Latch Cutout (Add to list price) Per Cutout	US28	28.20	
	US32D	28.20	
UL Rated (Add to list price) Per Cutout	US32D	17.05	

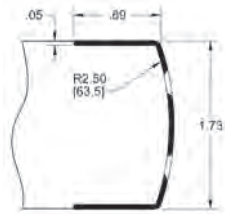

Description	Finish	2021 List	Case Qty.
180Q			
Door Edgings - Mortise Type			5
Material: Aluminum, stainless steel	≤42"	US28 89.55	
Thickness: .045 - .050"		US32D 113.35	
Fasteners: #6 x 5/8" FPHSMS (Self drilling) #6 x 1" screws available on request.	>42" - 96"	US28 178.10	
Standard edge guards made for 1-3/4" +0/-1/32" door thickness. Please provide actual door thickness. Cutouts will hand product, specify handling. Other lengths by quotation.		US32D 226.70	
Hinge Cutout (Add to list price) Per Cutout	US28	28.20	
	US32D	28.20	
Bolt Cutout (Add to list price) Per Cutout	US28	28.25	
	US32D	28.25	
Latch Cutout (Add to list price) Per Cutout	US28	28.20	
	US32D	28.20	
UL Rated (Add to list price) Per Cutout	US32D	17.05	

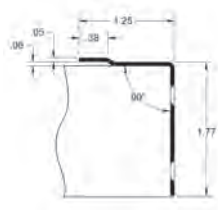

181H			
Door Edgings - Overlap Type			5
Material: Aluminum, stainless steel	≤42"	US28 66.20	
Thickness: .045 - .050"		US32D 92.40	
Fasteners: #6 x 5/8" FPHSMS (Self drilling) #6 x 1" screws available on request.	>42" - 96"	US28 132.35	
Standard edge guards made for 1-3/4" +0/-1/32" door thickness. Please provide actual door thickness. Cutouts will hand product, specify handling. Other lengths by quotation.		US32D 184.80	
Hinge Cutout (Add to list price) Per Cutout	US28	28.20	
	US32D	28.20	
Bolt Cutout (Add to list price) Per Cutout	US28	28.25	
	US32D	28.25	
Latch Cutout (Add to list price) Per Cutout	US28	28.20	
	US32D	28.20	
UL Rated (Add to list price) Per Cutout	US32D	17.05	

1. Items with the price in **bold and red** are Quick Ship items and ship in 24 hours. Please use stock number when ordering. 2. U/M is each unless otherwise noted.



Trim & Auxiliary

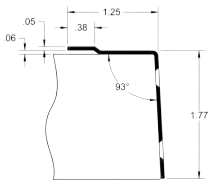

Description	Finish	2021 List	Case Qty.
181K			
Door Edgings - Overlap Type	≤42"	US28 61.85	5
Material: Aluminum, stainless steel	US32D	86.50	
Thickness: .045 - .050"	>42" - 96"	US28 123.70	5
Fasteners: #6 x 5/8" FPHSMS (Self drilling) #6 x 1" screws available on request.	US32D	173.05	
Standard edge guards made for 1-3/4" +0/-1/32" door thickness. Please provide actual door thickness. Cutouts will hand product, specify handling. Other lengths by quotation.			
Hinge Cutout (Add to list price) Per Cutout	US28	28.20	
	US32D	28.20	
Bolt Cutout (Add to list price) Per Cutout	US28	28.25	
	US32D	28.25	
Latch Cutout (Add to list price) Per Cutout	US28	28.20	
	US32D	28.20	
UL Rated (Add to list price) Per Cutout	US32D	17.05	

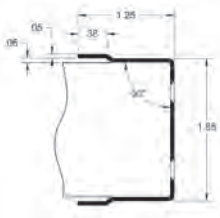

181M			
Door Edgings - Overlap Type	≤42"	US28 83.65	5
Material: Aluminum, stainless steel	US32D	105.95	
Thickness: .045 - .050"	>42" - 96"	US28 167.25	5
Fasteners: #6 x 5/8" FPHSMS (Self drilling) #6 x 1" screws available on request.	US32D	211.85	
Standard edge guards made for 1-3/4" +0/-1/32" door thickness. Please provide actual door thickness. Cutouts will hand product, specify handling. Other lengths by quotation.			
Hinge Cutout (Add to list price) Per Cutout	US28	28.20	
	US32D	28.20	
Bolt Cutout (Add to list price) Per Cutout	US28	28.25	
	US32D	28.25	
Latch Cutout (Add to list price) Per Cutout	US28	28.20	
	US32D	28.20	
UL Rated (Add to list price) Per Cutout	US32D	17.05	

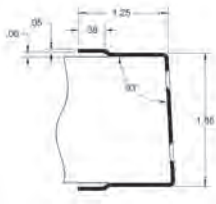

Description	Finish	2021 List	Case Qty.
181P			
Door Edgings - Overlap Type	≤42"	US28 87.85	10
U/M - each		US32D 109.80	
Material: Aluminum, stainless steel	>42" - 96"	US28 175.70	10
Thickness: .045 - .050"		US32D 219.60	
Fasteners: #6 x 5/8" FPHSMS (Self drilling) #6 x 1" screws available on request.			
Standard edge guards made for 1-3/4" +0/-1/32" door thickness. Please provide actual door thickness.			
Cutouts will hand product, specify handling. Other lengths by quotation.			
Hinge Cutout (Add to list price) Per Cutout	US28	28.20	
	US32D	28.20	
Bolt Cutout (Add to list price) Per Cutout	US28	28.25	
	US32D	28.25	
Latch Cutout (Add to list price) Per Cutout	US28	28.20	
	US32D	28.20	
UL Rated (Add to list price) Per Cutout	US32D	17.05	



181Q			
Door Edgings - Overlap Type	≤42"	US28 93.70	5
Material: Aluminum, stainless steel		US32D 105.80	
Thickness: .045 - .050"	>42" - 96"	US28 187.35	5
Fasteners: #6 x 5/8" FPHSMS (Self drilling) #6 x 1" screws available on request.		US32D 211.55	
Standard edge guards made for 1-3/4" +0/-1/32" door thickness. Please provide actual door thickness.			
Cutouts will hand product, specify handling. Other lengths by quotation.			
Hinge Cutout (Add to list price) Per Cutout	US28	28.20	
	US32D	28.20	
Bolt Cutout (Add to list price) Per Cutout	US28	28.25	
	US32D	28.25	
Latch Cutout (Add to list price) Per Cutout	US28	28.20	
	US32D	28.20	
UL Rated (Add to list price) Per Cutout	US32D	17.05	

1. Items with the price in **bold and red** are Quick Ship items and ship in 24 hours. Please use stock number when ordering. 2. U/M is each unless otherwise noted.



Trim & Auxiliary

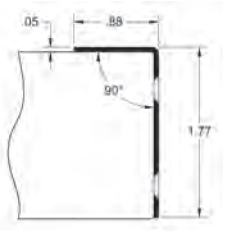

Description	Finish	2021 List	Case Qty.
182H			
Door Edgings - Surface	US28	39.75	10
Non-Mortise Type	US32D	61.85	
Material: Aluminum, stainless steel			
Thickness: .045 - .050"	US28	79.50	10
Fasteners: #6 x 5/8" FPHSMS (Self drilling) #6 x 1" screws available on request.	US32D	123.70	
Standard edge guards made for 1-3/4" +0/-1/32" door thickness. Please provide actual door thickness.			
Cutouts will hand product, specify handling. Other lengths by quotation.			
Hinge Cutout (Add to list price) Per Cutout	US28	28.20	
	US32D	28.20	
Bolt Cutout (Add to list price) Per Cutout	US28	28.25	
	US32D	28.25	
Latch Cutout (Add to list price) Per Cutout	US28	28.20	
	US32D	28.20	
UL Rated (Add to list price) Per Cutout	US32D	17.05	

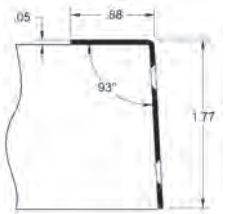

182K			
Door Edgings - Surface	US28	42.45	10
Non-Mortise Type	US32D	50.50	
Material: Aluminum, stainless steel			
Thickness: .045 - .050"	US28	84.85	10
Fasteners: #6 x 5/8" FPHSMS (Self drilling) #6 x 1" screws available on request.	US32D	101.05	
Standard edge guards made for 1-3/4" +0/-1/32" door thickness. Please provide actual door thickness.			
Cutouts will hand product, specify handling. Other lengths by quotation.			
Hinge Cutout (Add to list price) Per Cutout	US28	28.20	
	US32D	28.20	
Bolt Cutout (Add to list price) Per Cutout	US28	28.25	
	US32D	28.25	
Latch Cutout (Add to list price) Per Cutout	US28	28.20	
	US32D	28.20	
UL Rated (Add to list price) Per Cutout	US32D	17.05	

1. Items with the price in **bold and red** are Quick Ship items and ship in 24 hours. Please use stock number when ordering. 2. U/M is each unless otherwise noted.

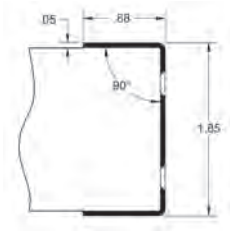

Description	Finish	2021 List	Case Qty.
182M			
Door Edgings - Surface			
Non-Mortise Type	≤42"	US28 66.60	10
Material: Aluminum, stainless steel		US32D 87.15	
Thickness: .045 - .050"	>42" - 96"	US28 133.20	10
Fasteners: #6 x 5/8" FPHSMS (Self drilling) #6 x 1" screws available on request.		US32D 174.30	
Standard edge guards made for 1-3/4" +0/-1/32" door thickness. Please provide actual door thickness.			
Cutouts will hand product, specify handling. Other lengths by quotation.			
Hinge Cutout (Add to list price) Per Cutout	US28	28.20	
	US32D	28.20	
Bolt Cutout (Add to list price) Per Cutout	US28	28.25	
	US32D	28.25	
Latch Cutout (Add to list price) Per Cutout	US28	28.20	
	US32D	28.20	
UL Rated (Add to list price) Per Cutout	US32D	17.05	

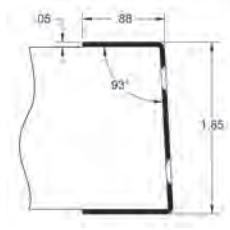

182P			
Door Edgings - Surface			
Non-Mortise Type	≤42"	US28 70.65	10
Material: Aluminum, stainless steel		US32D 92.15	
Thickness: .045 - .050"	>42" - 96"	US28 141.30	10
Fasteners: #6 x 5/8" FPHSMS (Self drilling) #6 x 1" screws available on request.		US32D 184.25	
Standard edge guards made for 1-3/4" +0/-1/32" door thickness. Please provide actual door thickness.			
Cutouts will hand product, specify handling. Other lengths by quotation.			
Hinge Cutout (Add to list price) Per Cutout	US28	28.20	
	US32D	28.20	
Bolt Cutout (Add to list price) Per Cutout	US28	28.25	
	US32D	28.25	
Latch Cutout (Add to list price) Per Cutout	US28	28.20	
	US32D	28.20	
UL Rated (Add to list price) Per Cutout	US32D	17.05	

1. Items with the price in **bold and red** are Quick Ship items and ship in 24 hours. Please use stock number when ordering. 2. U/M is each unless otherwise noted.



Trim & Auxiliary

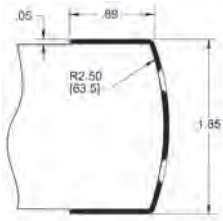

Description	Finish	2021 List	Case Qty.
182Q			
Door Edgings - Surface	US28	89.85	10
Non-Mortise Type	US32D	113.35	
Material: Aluminum, stainless steel	US28	179.75	10
Thickness: .045 - .050"	US32D	226.70	
Fasteners: #6 x 5/8" FPHSMS (Self drilling) #6 x 1" screws available on request.			
Standard edge guards made for 1-3/4" +0/-1/32" door thickness. Please provide actual door thickness.			
Cutouts will hand product, specify handling. Other lengths by quotation.			
Hinge Cutout (Add to list price) Per Cutout	US28	28.20	
	US32D	28.20	
Bolt Cutout (Add to list price) Per Cutout	US28	28.25	
	US32D	28.25	
Latch Cutout (Add to list price) Per Cutout	US28	28.20	
	US32D	28.20	
UL Rated (Add to list price) Per Cutout	US32D	17.05	



Description	Finish	2021 List	Stock No.	Box Qty.	Case Qty.
185G					
Corner Guard	US28	92.00	-	-	-
Material: Aluminum, stainless steel	w/tape				
Size: 3" x 3" x 40"	US32D w/tape	112.40	062999		
Thickness: .050"	US28	60.90	044109		
Fasteners: #6 x 5/8" FPHSMS self drilling	US32D	82.20	087970		
#6 x 1" screws available upon request.					
Other lengths by quotation.					
230W					
Convex Wall Stop	US3	9.25	053679	10	100
Concealed Mounting	US4	11.90	053680		
Material: Cast brass or bronze	US10	11.95	053681		
Stop: Rubber	US10B	11.95	053683		
Diameter: 2-15/32"	US15	16.65	094602		
Projection: 1-3/32"	US15A	16.65	054038		
Fastener: #10 x 1-1/2" PPHWS with plastic and toggle anchor	US19	11.95	073621		
Add optional 230T machine screw with metal toggle nut screwpack - 0.70 each list.	US26	14.90	053682		
	US26D	7.80	053684		





Description	Finish	2021 List	Stock No.	Box Qty.	Case Qty.
232W					
Convex Wall Stop	US3	4.00	051972	10	100
Concealed Mounting	US4	4.00	053231		
Material: Wrought brass, bronze or stainless steel	US5	10.25	072846		
Stop: Rubber	US9	10.15	017030		
Diameter: 2-7/16"	US10	4.00	051973		
Projection: 1"	US10B	4.00	051974		
Fastener: #10 x 1-1/2" PPHWS with plastic and toggle anchor	US15	10.30	046072		
Add optional 230T machine screw with metal toggle nut screwpack - 0.70 each list.	US15A	10.30	062556		
	US19	4.00	071703		
	US26	4.15	051975		
	US26D	3.90	051976		
	US32	10.30	053691		
	US32D	2.85	053678		



234W					
Concave Wall Stop					
Material: Cast brass or bronze	US3	9.25	053227	10	100
Stop: Rubber	US4	11.90	053228		
Diameter: 2-15/32"	US10	11.95	053229		
Projection: 1-3/32"	US10B	11.95	053230		
Fastener: #10 x 1-1/2" PPHWS with plastic and toggle anchor	US15	16.65	094603		
Add optional 230T machine screw with metal toggle nut screwpack - 0.70 each list.	US15A	16.65	054039		
	US19	11.95	067951		
	US26	14.90	053235		
	US26D	7.80	053236		



236W					
Concave Wall Stop					
Material: Wrought brass, bronze or stainless steel	US3	4.00	051977	10	100
Stop: Rubber	US4	4.00	053237		
Diameter: 2-7/16"	US5	10.25	072849		
Projection: 1"	US9	10.15	018702		
Fastener: #10 x 1-1/2" PPHWS with plastic and toggle anchor	US10	4.00	051978		
Add optional 230T machine screw with metal toggle nut screwpack - 0.70 each list.	US10B	4.00	051979		
	US15	10.25	014846		
	US15A	10.25	054522		
	US19	4.00	018437		
	US26	4.15	051980		
	US26D	3.90	051981		
	US32	10.15	053238		
	US32D	2.85	053239		



Trim & Auxiliary



Description	Finish	2021 List	Stock No.	Box Qty.	Case Qty.
241F					
Dome Stop - Low	US3	6.95	051982	10	100
Material: Die cast brass	US4	6.85	053259		
Base Diameter: 1-11/16"	US5	11.20	072845		
Base: 1/8" Thick	US9	11.20	056749		
Height: 1"	US10	7.85	051983		
Fastener: #14 x 1-1/2" with plastic anchor	US10B	6.90	051984		
and 1/4-20 x 3/4" FPHMS with lead anchor	US15	8.55	034785		
	US15A	11.20	054041		
	US19	6.90	073625		
	US26	6.85	051985		
	US26D	6.45	052148		



242F					
Dome Stop - Universal	US3	10.75	075489	10	100
Material: Forged brass	US4	10.75	099613		
Base Diameter: 1-11/16"	US10B	11.35	075488		
Base: 7/32" Thick	US15	12.55	094363		
Height: 1-5/8"	US26	11.05	081314		
Fastener: #14 x 1-1/2" FPHWS with plastic anchor	US26D	9.50	075487		
and 1/4 - 20 x 3/4" FPHMS with lead anchor					



243F					
Dome Stop - High	US3	7.85	051986	10	100
Material: Die cast brass	US4	7.85	053268		
Base Diameter: 1-11/16"	US5	12.75	077629		
Base: 7/16" Thick	US9	12.75	056750		
Height: 1-9/32"	US10	8.85	052149		
Fastener: #14 x 1-1/2" FPHWS with plastic anchor	US10B	8.00	052328		
and 1/4 - 20 x 1-1/4" FPHMS with lead anchor	US15	9.40	035110		
	US15A	12.75	054043		
	US19	8.00	068921		
	US26	8.00	052329		
	US26D	6.65	052150		



244F					
Cast Floor Stop	US3	22.85	097343	5	50
Material: Cast brass	US4	22.85	058458		
Base: 1-3/4" x 4"	US10	22.40	097344		
Base Thickness: 5/32"	US10B	22.40	097345		
O/A Height: 1"	US26	23.10	097346		
Fasteners: #14 x 1-1/2" FPHWS with plastic anchor;	US26D	14.30	097347		
1/4 - 20 x 3/4" FPHMS with lead anchor					





Description	Finish	2021 List	Stock No.	Box Qty.	Case Qty.
245F	US10B	31.05	097350	5	50
	US26	32.00	097351		
	US26D	21.35	097352		



246B Dome Stop Riser Plate Material: Brass Diameter: 1-3/4" Base: 3/8" thick For use with 241F	Mil	6.25	052934	10	100
	US3	3.55	054344		
	US4	3.55	066234		
	US10	3.80	059349		
	US10B	3.80	054443		
	US15	8.25	061758		
	US15A	8.25	054044		
	US19	3.80	054523		
	US26	3.55	066412		
	US26D	3.05	055308		



248G Modern Style Universal Stop Material: Brass w/ gray rubber bumper Diameter: 1-7/16" Height: 1-1/2" Fasteners: 1/4 - 20 x 1" FPHMS with lead anchor; #12 x 1-1/4" FPHWS with plastic anchor	US26D	20.50	159656	10	100
--	-------	-------	--------	----	-----



248F Modern Style Universal Stop Material: Brass w/ black rubber bumper Diameter: 1-7/16" Height: 1-1/2" Fasteners: 1/4 - 20 x 1" FPHMS with lead anchor; #12 x 1-1/4" FPHWS with plastic anchor	US26D	20.50	023442	10	100
---	-------	-------	--------	----	-----













249F L-Shaped Floor Stop Material: Steel with rubber bumper Height: 2-5/8" Base: 1" x 2-1/2" x 7/32" thick Fastener: #14 x 1-1/2" FPHWS with plastic anchor	US2C	8.80	011616	5	50
---	------	------	--------	---	----

1. Items with the price in **bold and red** are Quick Ship items and ship in 24 hours.
Please use stock number when ordering. 2. U/M is each unless otherwise noted.



Trim & Auxiliary

	Description	Finish	2021 List	Stock No.	Box Qty.	Case Qty.
	250W					
	Convex Wall Stop	US3	9.40	052784	20	200
	Material: Cast brass with rubber bumper	US4	9.40	056083		
	Diameter: 1"	US10	10.05	052785		
	Projection: 9/16"	US10B	10.05	052786		
	Fastener: #6 x 3/4" screw w/ anchor and .052" diameter nail	US15	12.90	061694		
		US15A	12.90	054045		
		US19	10.05	054526		
		US26	10.05	052787		
	US26D	10.05	053275			
	251W					
	Concave Wall Bumper	Grey	2.35	052935	20	200
	Material: Adhesive backed rubber					
	Diameter: 1-7/8"					
	Projection: 25/32"					
	252F					
	Floor Stop	US3	25.05	058522	5	50
	Material: Cast brass with rubber bumper	US10	27.05	058523		
	Diameter: 1-9/16" x 2-1/2"	US10B	24.95	058517		
	Height: 2-11/16"	US15	43.55	061610		
	Fastener: 1 ea. 1/4 - 20 x 3/4" FPHMS with lead anchor;	US15A	43.55	054046		
	5/16 - 18 x 2-1/2" stud with lead anchor;	US19	24.95	054531		
	#14 x 1-1/2" FPHWS with plastic anchor	US26	31.25	058518		
	2" max door to floor clearance	US26D	22.40	058519		
	254S					
	Wall Stop and Holder	US3	49.10	097810	5	50
	Material: Cast brass with rubber bumper	US4	49.10	030895		
	Base Diameter: 2-11/32"	US10B	57.35	097813		
	Base Projection: 3-1/2"	US15	57.35	061598		
	Engaged Projection: 5-19/32"	US26	57.35	097814		
	Keeper: 1" x 2"	US26D	57.35	097814		
Fastener: #10 x 1" FPHWS with plastic anchor						
	254W					
	Wall Stop and Holder	US3	49.10	097805	5	50
	Material: Cast brass with rubber bumper	US4	49.10	071803		
	Base Diameter: 2-11/32"	US10B	57.35	097807		
	Base Projection: 3-1/2"	US15	57.35	061570		
	Engaged Projection: 5-19/32"	US26	57.35	097808		
	Keeper: 1" x 2"	US26D	57.35	097809		
	Fastener: #10 x 1" FPHWS with plastic anchor;					
	5/16 - 18 x 2-1/2" stud with lead anchor					

	Description	Finish	2021 List	Stock No.	Box Qty.	Case Qty.
	255S					
	Wall Stop	US3	29.85	017532	5	50
	Material: Cast brass with rubber bumper	US4	29.85	017533		
	Base Diameter: 2-11/32"	US10	30.25	094583		
	Projection: 3-11/16"	US10B	30.25	017534		
	Fastener: #10 x 1" OPHWS with plastic anchor	US15	37.45	061568		
		US26	33.40	017531		
	US26D	21.85	000917			
	255W					
	Wall Stop	US3	29.85	058532	5	50
	Material: Cast brass with rubber bumper	US4	29.85	075493		
	Base Diameter: 2-11/32"	US10	30.25	058533		
	Projection: 3-11/16"	US10B	30.25	058534		
	Fastener: #10 x 1" OPHWS with plastic anchor;	US15	37.45	061567		
	5/16" - 18 x 2-1/2" threaded stud, 5/16" lead anchor	US26	33.40	058675		
	US26D	21.85	058535			
	256S					
	Wall Stop & Holder	US3	53.75	068146	5	50
	Material: Cast brass with rubber bumper	US10	42.85	070578		
	Base Diameter: 2-1/4"	US10B	44.90	099449		
	Engaged Projection: 5-11/16"	US26D	29.35	067225		
Projection: 3-25/32"						
Keeper: 25/32" x 1-1/2"						
Fastener: #10 x 1" OPHWS with plastic anchor						
	256W					
	Wall Stop & Holder	US3	53.75	058585	5	50
	Material: Cast brass with rubber bumper	US10	42.85	058586		
	Base Diameter: 2-1/4"	US10B	44.90	058587		
	Engaged Projection: 5-11/16"	US15	52.75	060860		
	Projection: 3-25/32"	US26	53.75	058520		
	Keeper: 25/32" x 1-1/2"	US26D	29.35	058521		
	Fastener: #10 x 1" OPHWS with plastic anchor;					
5/16" - 18 x 2-1/2" stud with lead anchor						
	257F					
	Floor Stop	US3	22.75	058546	5	50
	Material: Cast brass with rubber bumper	US10	26.40	058547		
	Base: 1-9/16" x 2-15/32"	US10B	23.40	058548		
	Height: 2"	US15	43.55	060857		
	Fastener: #14 x 1-1/2" FPHWS with plastic anchor;	US15A	43.55	054048		
	1/4 - 20 x 3/4" FPHMS with lead anchor;	US19	23.40	054532		
	5/16" - 18 x 2-1/2" stud with lead anchor	US26	29.60	058549		
	US26D	20.70	058550			

1. Items with the price in **bold and red** are Quick Ship items and ship in 24 hours.
Please use stock number when ordering. 2. U/M is each unless otherwise noted.



Trim & Auxiliary



Description	Finish	2021 List	Stock No.	Box Qty.	Case Qty.
258F					
Floor Stop & Holder	US3	41.30	058551	5	50
Material: Cast brass with rubber bumper	US10	37.60	058552		
Base: 1-9/16" x 2-15/32"	US10B	37.60	058553		
Height: 3"	US15	65.20	060855		
Keeper: 1" x 2"	US26	42.60	058554		
Fasteners: #10 x 1" FPHWS with plastic anchor;	US26D	30.10	058555		
1/4 - 20 x 3/4" FPHMS with lead anchor;					
5/16 - 18 x 2-1/2" stud with lead anchor					



259F					
Tri Base Floor Stop	US10B	26.25	086567	5	50
Material: Cast brass with rubber bumper	US26D	22.10	084984		
Base: 2-1/2" wide x 1-9/16" deep					
Height: 1-11/16"					
Fasteners: #10 x 1-1/4" FPHWS with plastic anchor;					
10 - 32 x 3/4" FPHMS with lead anchor					



259H					
Tri Base Floor Stop - Tall	US10B	29.85	006004	5	50
Material: Cast brass with rubber bumper	US26D	24.80	005661		
Base: 2-1/2" wide x 1-9/16" deep					
Height: 2-1/4"					
Fasteners: #10 x 1-1/4" FPHWS with plastic anchor;					
10 - 32 x 3/4" FPHMS with lead anchor					



260W					
Angled Wall Stop	US26D	43.65	059730	5	50
Material: Cast brass with rubber bumper					
Base: 2-3/16" wide x 2-15/16" tall					
Projection: 3-21/32"					
Fasteners: #14 x 1-1/2" FPHWS with plastic anchor and					
1/4 - 20 x 3/4" FPHMS with lead anchor					



267F					
Floor Stop	US3	28.85	058536	5	50
Material: Cast brass with rubber bumper	US10	29.85	058537		
Base: 2-1/4"	US10B	29.85	058538		
Height: 3-1/8"	US15	37.45	060853		
Fasteners: #10 x 1" OPHWS with plastic anchor;	US15A	37.45	031421		
5/16" - 18 x 2-1/2" stud with lead anchor	US19	29.85	033541		
	US26	33.40	058539		
	US26D	22.40	058540		





Description	Finish	2021 List	Stock No.	Box Qty.	Case Qty.
267S Cast Floor Stop	US3	23.80	097803	5	50
Material: Cast brass with rubber bumper	US10	28.85	097804		
Base: 2-1/4"	US10B	30.10	097800		
Height: 3-1/8"	US15	37.45	060851		
Fasteners: #10 x 1" OPHWS with plastic anchor	US26	33.40	097801		
	US26D	22.40	097802		



268F Floor Stop & Holder					
Material: Cast brass with rubber bumper					
Base: 2-1/4"					
Height: 3-19/32"	US3	54.55	058541	5	50
Keeper: 25/32" x 1-1/2"	US10	49.10	058542		
Fasteners: #10 x 1" OPHWS with plastic anchor;	US10B	51.30	058543		
5/16" - 18 x 2-1/2" stud with lead anchor	US15	49.10	075320		
	US15A	49.10	054050		
	US19	51.30	054533		
	US26	54.55	058544		
	US26D	30.60	058545		



268S Cast Floor Stop & Holder					
Material: Cast brass with rubber bumper	US3	54.55	070926	5	50
Base: 2-1/4"	US10	49.10	088879		
Height: 3-19/32"	US10B	51.30	072110		
Keeper: 25/32" x 1-1/2"	US15	49.10	060840		
Fasteners: #10 x 1" OPHW with plastic anchors	US26	54.55	095114		
	US26D	30.60	068934		



269F Heavy Duty Floor Stop					
Material: 5/8" Steel pin with rubber bumper	-	23.25	085062	5	50
Bumper: 1-1/2" high					
Diameter: 2"					
Steel Bolt: 5/8" - 11 x 2-1/2" thread					
Special Grout by others					

1. Items with the price in **bold and red** are Quick Ship items and ship in 24 hours.
Please use stock number when ordering. 2. U/M is each unless otherwise noted.



Trim & Auxiliary



Description	Finish	2021 List	Stock No.	Box Qty.	Case Qty.
269T Heavy Duty Floor Stop - Tall Material: 5/8" Steel pin with rubber bumper Bumper: 3-1/2" high Diameter: 2" Steel Bolt: 5/8" - 11 x 2-1/2" thread Special Grout by others	-	29.80	083131	3	30



270C Kick Down Door Holder Material: Cast iron with rubber tip Base: 1-7/16" x 2-1/8" Arm: 3-13/16" Fasteners: #6 x 3/4" OPHTS S1 - Sprayed Alum., S2 - Sprayed Brass, S3 - Sprayed Bronze 270CR replacement rubber tips available, 6 per bag	S1 S2 S3	13.95 13.95 13.95	058588 058589 058590	5	50
--	----------------	--------------------------------	----------------------------	---	----



270D Kick Down Door Holder Material: Cast brass with rubber tip Base: 1-19/32" x 1-25/32" Arm: 3-1/2" Fasteners: #6 x 3/4" OPHWS	US3 US10 US10B US15 US15A US19 US26 US26D	27.95 31.15 27.50 43.55 43.55 27.50 40.70 25.10	058525 058526 058527 060822 054051 054542 058568 058569	5	50
--	--	---	--	---	----



270R Replacement Rubber Tips Material: Black rubber For use with 270D or 271D door holders Sold in packs of 10	Rubber	28.55	073663	10	100
---	--------	-------	--------	----	-----



271D Kick Down Door Holder Material: Cast brass with rubber bumper Base: 1-19/32" x 1-25/32" Arm: 4-7/16" Fasteners: #6 x 3/4" OPHWS	US3 US10 US10B US26 US26D	49.10 49.10 49.10 49.10 49.10	058570 058571 058564 058565 058566	5	50
--	---------------------------------------	--	--	---	----





Description	Finish	2021 List	Stock No.	Box Qty.	Case Qty.
271W					
Roller Bumper	US3	29.80	123928	10	50
Material: Cast brass or bronze with rubber roller	US10	31.95	123929		
Base: 2"	US10B	32.55	123930		
Projection: 4-1/2"	US26	31.20	123931		
Fasteners: #10 x 1" FPHWS with plastic anchor	US26D	24.20	123927		



272W					
Material: Cast brass or bronze with rubber roller	US3	33.05	052779	10	100
Base: 2"	US10	34.05	052780		
Projection: 6-1/4"	US10B	34.00	052781		
Fasteners: #10 x 1" FPHWS with plastic anchor	US26	40.40	052782		
	US26D	30.30	052783		



273W					
Curved Roller Bumper	US3	29.25	043325	5	50
Material: Cast brass or bronze with rubber roller	US4	31.95	043326		
Projection: 2-21/32"	US10	29.25	043323		
Fasteners: #10 x 1" FPHWS with plastic anchor	US10B	31.95	043327		
	US26	35.00	043324		
	US26D	26.75	043328		

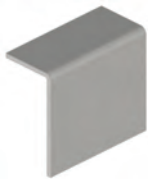

274B					
Door Guard Protective Plate	US3	5.90	048087	-	10
Material: Brass	US4	5.90	046942		
Fasteners: Double sided pressure sensitive tape	US10	5.90	048363		
To be used with the 274D	US10B	5.90	048365		
	US15	5.90	060811		
	US26	5.90	048364		
	US26D	5.90	048366		



274C					
Shim for Door Guard					
Material: Resilient black rubber, 3/32" thick	Black	2.10	158025	-	50
To be used with the 274D					



274D					
Material: Cast brass	US3	27.95	158021	5	50
Arm Length: 4-1/2"	US4	26.40	158022		
Fasteners: #6 x 3/4" OPHWS; #6 x 1-1/2" OPHWS;	US10	29.05	158016		
6 - 32 x 1/2" OPHMS	US10B	28.20	158017		
	US15	29.05	158018		
	US26	26.85	158019		
	US26D	23.80	158020		

1. Items with the price in **bold and red** are Quick Ship items and ship in 24 hours.
Please use stock number when ordering. 2. U/M is each unless otherwise noted.



Trim & Auxiliary



Description	Finish	2021 List	Stock No.	Box Qty.	Case Qty.
275D Surface Bolt - 8" Material: Steel Bolt Size: 1/4" x 3/4" Bolt Throw: 1" Fasteners: #10 x 1-1/4" FPHWS; 10 - 24 x 1" FPHMS Universal and angle strikes included	US3	29.05	058752	1	12
	US10	26.75	074243		
	US10B	29.80	056786		
	US26D	23.80	052287		



276D Surface Bolt - 12" Material: Steel Bolt Size: 1/4" x 3/4" Bolt Throw: 1" Fasteners: #10 x 1-1/4" FPHWS; 10 - 24 x 1" FPHMS Universal and angle strikes included	US3	21.65	083603	1	12
	US10	28.85	025645		
	US10B	75.80	073888		
	US26D	27.65	053325		



277D Privacy Door Latch Material: Cast Zinc Base: 2-5/8" x 1-9/16" Projection: 2-3/16" Fasteners: #12 x 1-3/4" FPHSMS	US3	38.40	161173	1	60
	US4	38.40	161174		
	US10B	54.90	161149		
	US15	52.15	190653		
	US26	37.45	161171		
	US26D	35.35	161172		
	US19	54.90	043187		



277F Privacy Door Guard Bracket Material: Cold Rolled Steel Finish: Primer Gray Fasteners: 12-24 FPH Self-tapping		11.60	63736		
--	--	-------	-------	--	--

277R Release Tool	N/A	18.64	094396	1	
-----------------------------	-----	-------	--------	---	--





Description	Finish	2021 List	Stock No.	Box Qty.	Case Qty.
278D Surface Bolt - 6" Material: Brass	US3	20.75	086661	10	100
Bolt Size: 7/16"	US10B	22.55	020392		
Bolt Throw: 31/32"	US26D	21.50	086662		
Projection: 3/4" Fasteners: #5 x 5/8" FPHWS Mortise and universal strikes included					



279D Dutch Door Bolt Material: Brass	US10B	47.15	023685	10	100
O/A Size: 1-11/16" x 4"	US26D	47.15	097354		
Bolt Size: 5/8" half round Bolt Throw: 3/8" Projection: 1-1/4" Knob Diameter: 29/32" Fasteners: #6 x 3/4" FPHWS Universal and angle strikes included					



280X Dust Proof Strike w/ Removable Plate	US3	20.25	052522	10	100
Material: Brass	US4	19.10	053326		
Face Plate: 1-7/16" x 2-29/32"	US9	26.85	021465		
Barrel Diameter: 1"	US10	21.40	052559		
Depth: 2-3/16"	US10B	20.80	052523		
Plunger Diameter: 3/4"	US15	25.25	040347		
Fasteners: #8 x 1" FPHWS with plastic anchors; spanner wrench	US15A	26.85	054052		
	US19	20.80	067955		
	US26	20.70	052839		
	US26D	17.80	052524		



281D Slide Flush Bolt Material: Brass or bronze w/ steel components	US3	13.85	056621	10	100
Face Plate: 3/4" x 6"	US4	14.45	056789		
Bolt Diameter: 1/2"	US5	19.65	035600		
Bolt Throw: 1"	US10	14.45	052723		
Strike: 7/8" x 1-3/4"	US10B	14.45	056790		
Rod Backset: 7/16"	US15	19.65	036438		
Fasteners: #6 x 3/4" FPHWS	US15A	19.65	054055		
	US19	14.45	054545		
	US26	16.75	052525		
	US26D	13.85	056791		

1. Items with the price in **bold and red** are Quick Ship items and ship in 24 hours.
Please use stock number when ordering. 2. U/M is each unless otherwise noted.



Trim & Auxiliary



Description	Finish	2021 List	Stock No.	Box Qty.	Case Qty.
282D					
Manual Flush Bolt	US3	20.95	052281	2	
Metal Doors	US4	20.95	052282		
Material: Brass w/ steel components	US5	34.55	062354		
Face Plate: 1" x 6-3/4"	US9	34.55	083207		
Bolt Throw: 3/4"	US10	21.35	052283		
Bolt Backset: 3/4"	US10B	21.35	052284		
Rod Length: 12"	US15	26.75	040346		
Strike: 15/16" x 2-1/4"	US15A	38.15	054056		
Fasteners: #8 x 3/4" combination screws	US19	21.35	067956		
For use with A115 Frame Preparation	US26	23.10	052285		
282S Strike plate bag and 282P bolt head available	US26D	19.50	052286		
282R Optional rod length available: 18", 24" and 30" (bolt head not included) - \$2.75 net.					
3-hour fire rating on metal doors up to 4 feet wide x 10 feet tall. Priced as each and in sets of 2.					



283D	US3	31.90	052929	2	40
Manual Flush Bolt	US4	31.90	053328		
Wood Composite Door	US5	64.05	018995		
Material: Brass w/ steel components	US9	64.05	032026		
Face Plate: 1" x 6-25/32"	US10	31.90	052930		
Bolt Head: 1/2" Square	US10B	30.90	052931		
Bolt Throw: 3/4"	US15	64.05	060810		
Bolt Backset: 3/4"	US15A	64.05	054057		
Strike: 15/16" x 2-1/4"	US19	30.90	054567		
Fasteners: #8 x 3/4" combination screws;	US26	33.30	052932		
1-1/2 hour fire rating on wood doors up to 4 feet wide x 10 feet tall	US26D	30.90	052933		



291D	US3	191.50	053297	1	10
Automatic Flush Bolts	US4	191.70	074059		
Wood Door	US10	191.70	053298		
Material: Stainless steel/brass w/ steel components	US10B	185.80	053299		
Face Plate: 1" x 8-1/2"	US15	262.25	046049		
Bolt Heads: 1/2" square	US32	262.25	117105		
Bolt Throw: 3/4"	US32D	180.30	117104		
Bolt Backset: 3/4"					
Fasteners: #10 x 1" SMS; #8 x 1" combination screws					
Mortise Strike: 15/16" x 2-1/4"					
280X Dust Proof Strike recommended					
1-1/2 hour fire rating on wood doors up to 4 feet wide x 9 feet tall					





Description	Finish	2021 List	Stock No.	Box Qty.	Case Qty.
292D					
Automatic Flush Bolts	US3	177.70	053301	1	10
Metal Doors	US4	177.70	084898		
Material: Stainless steel/brass w/ steel components	US10	177.70	053302		
Face Plate: 1" x 6-3/4"	US10B	172.40	053303		
Bolt Head: 1/2" square	US15	244.50	046052		
Bolt Throw: 3/4"	US32	244.50	117106		
Bolt Backset: 3/4"	US32D	167.25	117107		
Fasteners: #8 x 1" combination screws					
Mortise Strike: 15/16" x 2-1/4"					
280X Dust Proof Strike recommended					
1-1/2 hour fire rating on wood doors up to 4 feet wide x 9 feet tall					



293D					
Constant Latching Flush Bolts	US3	177.70	058567	1	10
Metal Doors	US4	177.70	087519		
Material: Stainless steel/brass w/ steel components	US10	177.70	058560		
Face Plate: 1" x 6-3/4"	US10B	172.40	058561		
Bolt Head: 1/2" square	US15	244.50	093481		
Bolt Throw: 3/4"	US32	244.50	117108		
Bolt Backset: 3/4"	US32D	167.25	117109		
Fasteners: #8 x 1" combination screws					
T-Strike: 1-1/8" x 2-3/4"					
280X Dust Proof Strike recommended					
1-1/2 hour fire rating on wood doors up to 4 feet wide x 9 feet tall					



294D					
Constant Latching Flush Bolts	US3	191.50	058563	1	10
Wood Door	US4	191.50	082014		
Material: Stainless steel/brass w/ steel components	US10	191.50	058556		
Face Plate: 1" x 8-1/2"	US10B	185.80	058557		
Bolt Head: 1/2" square	US15	262.25	095081		
Bolt Throw: 3/4"	US32	262.25	117111		
Bolt Backset: 3/4"	US32D	180.30	117110		
Fasteners: #10 x 1" SMS; #8 x 1" combination screws					
T-Strike: 1-1/8" x 2-3/4"					
280X Dust Proof Strike recommended					
1-1/2 hour fire rating on wood doors up to 4 feet wide x 9 feet tall					

1. Items with the price in **bold and red** are Quick Ship items and ship in 24 hours. Please use stock number when ordering. 2. U/M is each unless otherwise noted.



Trim & Auxiliary



Description	Finish	2021 List	Stock No.	Box Qty.	Case Qty.
295M					
Automatic Flush Bolt w/Fire Bolt	US3	141.25	080579	1	10
Metal Doors	US4	141.25	080582		
Material: Stainless steel/brass with steel components	US10	141.25	080583		
Face Plate: 1" x 6-3/4"	US10B	141.25	080584		
Bolt Head: 1/2" square	US15	195.60	060808		
Bolt Throw: 3/4"	US32	141.25	080585		
Bolt Backset: 3/4"	US32D	141.25	080586		
Fasteners: #8 x 1" combination screws					
T-strike: 15/16" x 2-1/4"					
3-hour fire rating for metal doors up to 4 feet wide x 9 feet tall					
295W					
Automatic Flush Bolt w/Fire Bolt	US3	152.15	080593	1	10
Wood Doors	US4	152.15	080594		
Material: Stainless steel/brass with steel components	US10	152.15	080592		
Face Plate: 1" x 8-1/2"	US10B	152.15	080591		
Bolt Head: Flattened 1/2" square	US15	168.45	060807		
Bolt Throw: 3/4"	US32	152.15	080590		
Backset: 3/4"	US32D	152.15	080589		
Fasteners: #10 x 1" SMS; #8 x 1" combination screws					
Mortise Strike: 15/16" x 2-1/4"					
20 minute fire rating for wood doors up to 4 feet wide x 9 feet tall					
296W					
Automatic Flush Bolt Set for Wood Doors	US3	340.20	083221	1	10
Backset: 1-1/2"	US4	340.20	083222		
Fasteners: Sixteen (16) #8 x 1" APS; four (4) plastic anchors	US10	340.20	083223		
Strike: 1-1/8" x 2-1/4"	US10B	340.20	083224		
1-1/2 hour fire rating for wood doors up to 4 feet wide x 9 feet tall	US15	340.20	060784		
	US32	340.20	083225		
	US32D	340.20	083226		
297C					
Carry Bar	USP	34.55	058524	2	20
Material: Stainless steel/brass	US3	61.50	058528		
Base: 1-3/4" x 2-1/4"	US10	61.50	058529		
Projection: 25/32"	US10B	61.50	058530		
Fasteners: 12 - 24 x 3/4" PPHMS with sex nuts	US15	61.50	060778		
For use on pairs of doors with astragal and 297D-298D coordinator.	US32	61.50	117361		
	US32D	61.50	117226		



Description	Finish	2021 List	Stock No.	Box Qty.	Case Qty.
297D Coordinator with Filler Bar Material: Steel Base: 1-5/8" x 5/8" Fasteners: 12-24 x 1-1/4" TPHMS; #8 x 1" combo screws If overall frame width is different than widths shown, consult Hager Customer Service. If active and inactive doors are unequal in length, consult Hager Customer Service for proper sizing. 60"	Black	122.50	069727	1	4
Coordinator with Filler Bar Material: Steel Fasteners: 12-24 x 1-1/4" TPHMS; #8 x 1" combo screws If overall frame width is different than widths shown, consult Hager Customer Service. If active and inactive doors are unequal in length, consult Hager Customer Service for proper sizing. 72"	Black	129.05	052312	1	4
96"	Black	143.65	052313	1	4



297F 297F Filler Bars Material: Steel Thickness: 5/8" standard 18-5/8" 42-5/8"	Black FB1	25.55	098884	-	-
	Black FB1	35.55	073866	-	-



297B Mounting Bracket Material: Aluminum Stop Height: .58" (15mm) Soffit Width: 1-3/8" x 5-1/2" Fasteners: 12-24 x thread forming	Black	24.70	053258	2	20
---	-------	--------------	--------	---	----



298D Gravity Coordinator Material: Cast brass w/rubber roller Base: 1-1/8" x 5-1/2" Projection: 7" Fasteners: #12 x 1" OPHWS; #6 x 3/4" FPHWS; #8 x 3/4" FPHWS; #8 x 3/4" TPHWS	US3	82.05	055123	1	10
	US10	81.85	060271		
	US10B	79.40	055124		
	US26D	67.65	055125		

1. Items with the price in **bold and red** are Quick Ship items and ship in 24 hours. Please use stock number when ordering. 2. U/M is each unless otherwise noted.



Trim & Auxiliary



Description	Finish	2021 List	Stock No.	Box Qty.	Case Qty.
300D Chain Door Check Material: Steel chain Base Plate: Cast zinc base, galvanized steel chain, EPDM rubber cover 1-1/2" x 1-1/2" Cover: EDPM Rubber Fasteners: #8 x 1" FPHSMS Optional grommet nut set available (part #1-320-9801)					
25"-1/2'+/- 1/2"	US26D	59.85	063667	1	10
30" +/- 1/2"	US26D	59.85	063668	1	10



301D Residential Hinge Pin Stop Material: Wrought steel with rubber bumpers Features: Works with both 1/4" and 5/16" hinge pins Must purchase an NRP hinge for use with this pin stop	US3	4.75	023366	5	50
	US26D	4.75	023363		



303W Handrail Bracket Material: Cast brass Base Diameter: 3-5/32" Base to Center of Rail: 2-3/4" Fasteners: #10 x 1-1/4" FPHWS with plastic anchor; 10 - 24 x 13/16" FPHMS with lead anchors	US3	79.65	053306	5	50
	US4	79.65	067806		
	US10	85.15	052151		
	US10B	85.15	053307		
	US26	85.15	052327		
	US26D	85.15	052152		



305D Wire Pull Material: 5/16" brass rod Projection: 1-9/32" Fasteners: 8 - 32 x 1" TPHMS CTC: 3"	US3	10.55	086821	10	100
	US4	10.90	-		
	US10	10.90	020779		
	US26	10.90	086823		
CTC: 3-1/2"	US26D	10.90	086822		
	US3	10.55	086824	10	100
	US4	10.90	007767		
	US10	10.90	089114		
	US26	10.90	086826		
CTC: 4"	US26D	10.90	086825		
	US3	10.55	086827	10	100
	US4	10.90	019788		
	US10	10.90	090240		
	US26	10.90	086829		
	US26D	10.90	086828		





Description	Finish	2021 List	Stock No.	Box Qty.	Case Qty.
307D Metal Frame Silencer Material: Rubber Diameter: 1/2" Projection: 1/8" U/M Bag of 100	Grey	11.40	052527	-	100
308D Wood Frame Silencer Base: 3/8" x 3/4" Projection: 9/64" U/M Bag of 100	Grey	17.10	052526	-	100
310C Conversion Kit Strike: 1-11/16" x 2-1/4" Filler Plate: 1-1/8" x 3-3/8" Fasteners: #10 x 1-1/2" FPHWS; #10 x 1" FPHWS; 8 - 32 x 1/4" FPHMS; 10 - 24 x 1/2" FPHMS Converts Roller Latch to Push Pull Latch	US26D	55.00	711114	5	50
311H Push/Pull Latch Material: Zinc, stainless steel; Door Thickness: 1-3/4"; Bolt Throw: 1/2" Standard Backset: 2-3/4" Standard; 5" Optional; Projection: 2-5/8"; Strike: ASA 1-1/4" x 4-7/8" Standard T-Strike 1-1/8" x 2-3/4" Standard; Horizontal Mounting w/ 5" Backset Options: Engraving Handed: A (Standard) - "PUSH" down; "PULL" down. B - "PUSH" up; "PULL" down. C - "PUSH" up; "PULL" up. D - "PUSH" down; "PULL" up. 2-3/4"					
	US26	247.80	161063	1	10
	US26D	201.30	161064		
	US32	305.30	161067		
	US32D	239.30	161068		
	US26	247.80	161069	1	10
	US26D	201.30	161070		
	US32	305.30	161071		
	US32D	239.30	161072		
5"	US26	294.95	161069	1	10
	US26D	239.55	161066		
	US32	346.05	-		
	US32D	329.55	161073		
Lead Lined 2-3/4"	US26	294.95	-	1	10
	US26D	239.55	161076		
	US32	346.05	-		
	US32D	329.55	161080		

313S Anti-Vandal Trim Material: 11 GA stainless steel Max Projection: 1-7/8" Size: 6-11/32" x 11" Door Thickness: 1-3/4" Fasteners: 1/4 - 20" FPHMS with finish washers Available with latchguard (313L). Cylinder cutout available. Can be used with exit devices and mortise locks.	US32D (Plastisol no longer available)				
--	--	--	--	--	--

Please see the Exit Sections for pricing with Hager Model 4500 Rim Devices. All other combinations, including those with alternate Exit and Lock manufacturers, are priced on application.

1. Items with the price in **bold and red** are Quick Ship items and ship in 24 hours. Please use stock number when ordering. 2. U/M is each unless otherwise noted.



Trim & Auxiliary



Description	Finish	2021 List	Stock No.	Box Qty.	Case Qty.
318D					
Roller Latch	US3	33.30	055119	1	50
Material: Brass	US4	47.05	055120		
Latch Faceplate: 1" x 3-3/8"	US10	47.05	055121		
Strike: 1-1/4" x 2-3/4"	US10B	34.15	055122		
Strike Thickness: .171"	US15	63.50	078198		
Max Roller Projection: 3/8"	US19	34.15	054569		
Fasteners: #8 x 1" FPHWS; 8 - 32 x 3/4" FPHMS;	US26	34.90	055127		
#10 x 1-1/2" FPHWS	US26D	28.20	055126		



318S					
Roller Latch with Stop	US3	69.60	087304	1	50
Material: Brass	US4	69.70	087305		
Latch Face: 1-7/16" x 4-7/16"	US10	69.70	075533		
Angle Stop: 9/16" x 4-7/16"	US10B	67.65	055304		
Strike: 1-1/4" x 2-1/4"	US26	75.65	087306		
Strike Thickness: .171"	US26D	49.95	055305		
Max Roller Projection: 3/8"					
Fasteners: 8 - 32 x 3/4" FPHMS; #10 x 1-1/2" FPHWS					



320R					
Roller Latch	US3	43.20	049988	1	50
Material: Brass with nylon roller	US4	43.20	049989		
Latch Face: 2-1/4" x 1-1/8"	US9	86.85	049990		
Strike: 1-1/8" x 2-3/4"	US10	43.20	049987		
Strike Thickness: .058 wrought	US10B	46.10	049994		
Max Roller Projection: 7/16"	US15	47.50	060809		
Fasteners: #8 x 1" FPHWS	US26	43.20	049993		
	US26D	28.50	049995		







321R					
Adjustable Ball Catch	US3	18.40	055947	1	50
Material: Brass with steel ball roller	US4	18.40	055953		
Latch Face: 1" x 2-1/8"	US10	21.90	055944		
Strike: 1-1/2" x 2-1/8"	US10B	21.90	055960		
Strike Thickness: .050"	US15	21.90	075224		
Fasteners: #6 FPHWS	US15A	21.90	055961		
	US19	21.90	055945		
	US26D	18.40	055963		



322V					
Door Knocker w/ 115° Viewer	US3	30.35	056479	1	50
Material: Wrought brass	US10	34.00	056593		
Knocker Size: 2-7/32" x 3-1/4"	US26D	30.35	056478		
Projection: 19/32"					
Fasteners: #6 x 3/4" TPHSMS					



Description	Color	2021 List	Stock No.	Box Qty.	Case Qty.
 <p>323S Three-Way Ball Catch Material: Brass with Stainless Steel Balls Body: 1/2" x 2-3/16" x 1/2" Strike: 3/8" x 1-3/8" x 5/8"</p>	US26D	18.85	158659	30	300
	<hr/>				
 <p>324W Light Duty Wall Bumper Material: Brass or bronze Base: 1-1/4" diameter Projection: 3-1/4" Tip Diameter: 5/8" Fasteners: #10 x 7/8" wood thread Replacement rubber tip available (Part # 1-269-3073)</p>	US3	9.25	013810	1	50
	US4	9.90	013811		
	US5	11.05	013814		
	US10	11.05	013809		
	US10B	11.05	013812		
	US15	11.05	040348		
	US15A	11.05	013813		
	US19	11.05	030873		
	US26	9.60	013808		
	US26D	9.60	013807		
<hr/>					
 <p>326F Automatic Floor Stop and Holder Material: Cast brass Holder Base: 3-1/16" x 3-1/2" Projection: 1-15/16" Floor Strike: 2" x 4-3/32" Strike Height: 1-1/4" Max Door to Floor Clearance: 1/2" or less Fasteners: 4 ea. 12-24 x 1" TPHMS and #12 x 1" TPHWS; 3 ea. #14 x 1-1/2" FPHWS and anchors; 1/4 - 20 x 3/4" FPHMS with lead anchor</p>	US3	75.05	058510	5	30
	US10	79.15	058511		
	US10B	79.15	058512		
	US26	79.15	058507		
	US26D	79.15	058508		
	<hr/>				
 <p>326W Automatic Wall Stop and Holder Material: Cast brass Holder Base: 2-13/32" x 2-25/32" Holder Projection: 2-5/16" Engaged Projection: 3-5/8" Strike Base: 1" x 2-1/16" Strike Projection: 2" Fasteners: #10 x 1" OPHWS and anchors; 10 - 24 x 1-1/4" FPHMS</p>	US3	83.35	058513	5	30
	US10	87.50	058514		
	US10B	87.50	058515		
	US26	87.50	058516		
	US26D	87.50	058509		
	<hr/>				

1. Items with the price in **bold and red** are Quick Ship items and ship in 24 hours.
Please use stock number when ordering. 2. U/M is each unless otherwise noted.



Trim & Auxiliary



Description	Finish	2021 List	Stock No.	Box Qty.	Case Qty.
327F					
Automatic Floor Stop and Holder	US3	75.05	034684	5	30
Material: Cast brass	US10	79.15	085315		
Holder Base: 3-1/16" x 3-1/2"	US10B	79.15	076374		
Projection: 1-15/16"	US26	79.15	037584		
Floor Strike: 2" x 4-3/32"	US26D	79.15	029249		
Strike Height: 1-3/4"					
Max Door to Floor Clearance: 9/16" to 1-1/16"					
Fasteners: 4 ea. x 12-24 x 1" TPHMS and #12 x 1" TPHWS;					
3 ea. #14 x 1-1/2" FPHWS and anchors;					
1/4 - 20 x 3/4" FPHMS with lead anchor					







327W					
Automatic Wall Stop and Holder					
Material: Cast brass					
Holder Base: 3-1/16" x 3-1/2"					
Holder Projection: 1-15/16"	US4	125.90	098619	5	20
Engaged Projection: 3-1/2"	US10	125.90	098617		
Strike Diameter: 2-3/8"	US10B	125.90	098615		
Strike Projection: 3-1/16"	US26D	118.70	098612		
Fasteners: #12 x 1" TPHWS; 12-24 x 1" TPHMS;					
1/4" - 20 x 3/4" FPHMS with lead anchor;					
#14 x 1-1/2" FPHWS					
Strike is adjustable 45° left or right					



328F					
Automatic Floor Stop and Holder					
Material: Cast brass					
Holder Base: 3-1/16" x 3-1/2"					
Projection: 1-15/16"	US3	75.05	043083	5	30
Floor Strike: 2" x 4-3/32"	US10B	79.15	045516		
Strike Height: 2-1/4"	US26	79.15	018850		
Max Door to Floor Clearance: 1-1/8" to 1-9/16"	US26D	79.15	032493		
Fasteners: 4 ea. 12-24 x 1" TPHMS and #12 x 1" TPHWS;					
3 ea. #14 x 1-1/2" FPHWS and anchors;					
1/4 - 20 x 3/4" FPHMS with lead anchor					



	Description	Finish	2021 List	Stock No.	Box Qty.	Case Qty.
	329F					
	Automatic Floor Stop and Holder	US3	75.05	078700	5	30
	Material: Cast brass	US10	79.15	040616		
	Holder Base: 3-1/16" x 3-1/2"	US10B	79.15	044158		
	Projection: 1-15/16"	US26	79.15	116003		
	Strike Height: 2-3/4"	US26D	79.15	029252		
	Floor Strike: 2" x 4-3/32"					
Max Door to Floor Clearance: 1-5/8" to 2-1/16"						
Fasteners: 4 ea. 12-24 x 1" TPHMS and #12 x 1" TPHWS;						
3 ea. #14 x 1-1/2" FPHWS and anchors;						
1/4 - 20 x 3/4" FPHMS with lead anchor						
	330D					
	Pocket Door Latch	US3		086840	1	20
	Material: Brass	US5		086841		
	Fits: 1-3/8" - 1-3/4" door	US10	See Sliding Door Hardware Section for Pricing	066707		
	Size: 2-3/4" x 2-1/2"	US10B		056768		
	Finger Pull Extends: 1-3/8"	US15		078972		
	Fasteners: #6 x 5/8" OPHWS	US15A		054061		
		US19		054570		
		US26		086837		
		US26D		086838		
	330L					
	Privacy Pocket Door Latch	US3		143162	1	20
	Material: Brass	US5		143164		
	Size: 2-3/4" x 2-1/2"	US10	See Sliding Door Hardware Section for Pricing	143165		
	Finger Pull Extends: 1-3/8"	US10B		143158		
	Strike: 1" x 2-1/4"	US15		143159		
	1-3/8" doors	US15A		143160		
	Fasteners: #6 x 5/8" OPHWS; #6 x 3/4" FPHWS	US19		143166		
		US26		143167		
		US26D		143161		
	330M					
	Privacy Pocket Door Latch					
	Material: Brass					
	Size: 2-3/4" x 2-1/2"					
	Finger Pull Extends: 1-3/8"	US3		143172	1	20
	Strike: 1" x 2-1/4"	US5	See Sliding Door Hardware Section for Pricing	143178		
	1-3/4" doors	US10		143168		
	Fasteners: #6 x 5/8" OPHWS; #6 x 3/4" FPHWS	US10B		143169		
		US15		143173		
		US15A		143174		
	US19		143175			
	US26		143170			
	US26D		143171			

1. Items with the price in **bold and red** are Quick Ship items and ship in 24 hours. Please use stock number when ordering. 2. U/M is each unless otherwise noted.



Trim & Auxiliary



Description	Finish	2021 List	Stock No.	Box Qty.	Case Qty.
334V Door Knocker w/ 115° Viewer Material: Solid cast brass Knocker Size: 3-9/16" x 6-3/4" Fasteners: Two (2) 8-32 x 2 FHMS for standard 1-3/4" doors Two (2) #8 finish washers Two (2) 8-32 x 1-5/8" FHMS for 1-3/8" doors	US3 US4 US10 US10B US26 US26D	40.20 39.25 42.70 42.70 40.20 39.25	185001 185005 185003 185004 185002 185000	1	50
Lettering Available- up to four characters, Arial, 1/2" tall, black - \$6.00 total added to net price. Not available on US10B finish.					
336A 161 Prep - Door Edge Filler Plate Gauge: .134" Size: 1-1/8" x 2-1/4"	Primed steel	2.60	023352	25	250
336B 86 Prep - Door Edge Filler Plate Gauge: .180 Size: 1-1/4" x 8"	Primed steel	4.10	023329	25	250
336C Door Face Filler Plate Gauge: .055" Size: 1-3/4" Diameter	Primed steel	3.45	023346	25	250
336D Door Face Filler Plate Gauge: .055 Size: 2-5/8" Diameter	Primed steel	3.90	023343	25	250
336E Square - Door Edge Filler Plate Gauge: .134 Size: 1-3/4" x 4-1/2"	Primed steel	3.30	023334	25	250
336F Bevel - Door Edge Filler Plate Gauge: .134 Size: 1-1/2" x 4-1/2"	Primed steel	3.15	023332	25	250
336G Square - Door Edge Filler Plate Gauge: .134 Size: 1-3/4" x 5"	Primed steel	3.45	023340	25	250
336H Bevel - Door Edge Shim Filler Plate Gauge: .134 Size: 1-1/2" x 5"	Primed steel	3.05	023336	25	250
336J Frame - Flush Bolt Strike Filler Plate Gauge: .083 Size: 15/16" x 2-1/4"	Primed steel	2.15	023342	25	250





Description	Finish	2021 List	Stock No.	Box Qty.	Case Qty.
336K Door - Flush Bolt Filler Plate Gauge: .134 Size: 1" x 6-3/4"	Primed steel	3.65	023341	25	250
336L Frame - Hinge Filler Plate Gauge: .134 Size: 1-5/8" x 4-1/2"	Primed steel	3.05	023330	25	250
336M Frame - Hinge Filler Plate Gauge: .134 Size: 1-5/8" x 5"	Primed steel	3.45	023331	25	250
336N 86 to 161 Edge Prep Latch Adapter Filler Plate Gauge: .238 Size: 1-1/4" x 8"	Primed steel	7.30	023351	25	100
336P Frame - Deadlock Strike Filler Plate Gauge: .083 Size: 1-1/8" x 2-3/4"	Primed steel	2.40	082122	25	250
336Q Frame - ASA Strike Filler Plate Gauge: .093 Size: 1-1/4" x 4-7/8"	Primed steel	2.75	023356	25	250
336R Frame - Cylindrical Lock Strike Filler Plate Gauge: .083 Size: 1-1/8" x 2-3/4"	Primed steel	2.30	023354	25	250
337A Template Hinge Shim Gauge: .028 Size: 1-7/16" x 4-1/2"	Primed steel	1.30	023347	50	500
337B Template Hinge Shim Gauge: .065 Size: 1-7/16" x 4-1/2"	Primed steel	1.65	023348	50	500
337C Template Hinge Shim Gauge: .028 Size: 1-7/16" x 5"	Primed steel	1.65	023349	50	500
337D Template Hinge Shim Gauge: .065 Size: 1-7/16" x 5"	Primed steel	1.75	023350	50	500

1. Items with the price in **bold and red** are Quick Ship items and ship in 24 hours.
Please use stock number when ordering. 2. U/M is each unless otherwise noted.



Trim & Auxiliary



Description	Finish	2021 List	Stock No.	Box Qty.	Case Qty.
340D Latch Protector Plate with Frame Pin Material: 12 GA steel, stainless steel Size: 3" x 11" For 1-3/4" door thickness Fasteners: 5/16 - 20 x 1-1/2" carriage bolts with sex nuts For use w/ most mortise locks For use w/ cylindrical locksets with 3-3/4" backset or greater.	US2C US32D	14.40 28.50	041188 002179	1	10
341C Latch Protector Plate w/ Lock Cut Out Without Safety Studs Material: 12 GA steel, stainless steel Size: 3" x 11" For 1-3/4" door thickness Fasteners: 5/16 - 20 x 1-1/2" carriage bolts with sex nuts For use with cylindrical locksets with a 2-3/4" backset.	US32D	46.50	150739	1	10
341D Latch Protector Plate w/ Lock Cut Out with Frame Pin Material: 12 GA steel, stainless steel Size: 3" x 11" For 1-3/4" door thickness Fasteners: 5/16 - 20 x 1-1/2" carriage bolts with sex nuts For use with cylindrical locksets with a 2-3/4" backset.	US2C US32D	14.40 28.50	041191 002180	1	10
342D Latch Protector Plate w/ Escutcheon Cut Out Material: 12 GA steel, stainless steel Size: 3" x 11" For 1-3/4" door thickness Fasteners: 5/16 - 20 x 1-1/2" carriage bolts with sex nuts For use with cylindrical and mortise locksets	US32D	35.95	150740	1	10
345D Latch Protector Plate Material: 12 GA steel, stainless steel Size: 1-5/8" x 10" For 1-3/4" door thickness Fasteners: 5/16-20 x 1-1/2" carriage bolts with sex nuts For use with cylindrical and mortise locksets	US2C US32D	11.10 21.55	041194 002181	1	10



MEN

350M

Lettered Plastic Sign - MEN
 Material: .125" thick plastic
 Lettering: 3/4" Helvetica
 Size: 2" x 5"
 Signs are individually packed in a polybag

Brown (W1) w/ white lettering	16.35	089107	-	5
Black (W2) w/ white lettering	16.35	092413		
Blue (W3) w/ white lettering	16.35	090948		
Silver (B1) w/ black lettering	16.35	089108		
Gold (B2) w/ black lettering	16.35	-		

WOMEN

350W

Lettered Plastic Sign - WOMEN
 Material: .125" thick plastic
 Lettering: 3/4" Helvetica
 Size: 2" x 5"
 Fasteners: Double sided pressure sensitive tape, or screws (specify)
 Signs are individually packed in a polybag

Brown (W1) w/ white lettering	18.35	089103	-	5
Black (W2) w/ white lettering	18.35	092414		
Blue (W3) w/ white lettering	18.35	091068		
Silver (B1) w/ black lettering	18.35	089104		
Gold (B2) w/ black lettering	18.35	-		

PUSH

350H

Lettered Plastic Sign - PUSH
 Material: .125" thick plastic
 Lettering: 3/4" Helvetica
 Size: 2" x 4"
 Fasteners: Double sided pressure sensitive tape, or screws (specify)
 Signs are individually packed in a polybag

Brown (W1) w/ white lettering	18.35	089109	-	5
Black (W2) w/ white lettering	18.35	097215		
Blue (W3) w/ white lettering	18.35	032116		
Silver (B1) w/ black lettering	18.35	089110		

PULL

350L

Lettered Plastic Sign - PULL
 Material: .125" thick plastic
 Lettering: 3/4" Helvetica
 Size: 2" x 4"
 Fasteners: Double sided pressure sensitive tape, or screws (specify)
 Signs are individually packed in a polybag

Brown (W1) w/ white lettering	18.35	089111	-	5
Black (W2) w/ white lettering	18.35	097216		
Blue (W3) w/ white lettering	18.35	032117		
Silver (B1) w/ black lettering	18.35	089106		
Gold (B2) w/ black lettering	18.35	024447		

1. Items with the price in **bold and red** are Quick Ship items and ship in 24 hours. Please use stock number when ordering. 2. U/M is each unless otherwise noted.



Trim & Auxiliary

635

350R

Lettered Plastic Sign - Number	Brown (W1) w/ white lettering	16.35	000848	-	5
Material: .125" thick plastic	Black (W2) w/ white lettering	16.35	010640		
Lettering: 3/4" Helvetica	Blue (W3) w/ white lettering	16.35	119668		
Size: 2" x 4"	Silver (B1) w/ black lettering	16.35	067081		
Fasteners: Double sided pressure sensitive tape, or screws (specify)					
Signs are individually packed in a polybag					
Up to 3 characters (4 additional characters \$6.30)					

PUSH

351H

Lettered Plastic Sign - PUSH	Brown (W1) w/ white lettering	16.35	011628	-	5
Material: .125" thick plastic	Black (W2) w/ white lettering	16.35	016508		
Lettering: 3/4" Helvetica	Blue (W3) w/ white lettering	16.35	017432		
Size: 1" x 4-1/2"	Silver (B1) w/ black lettering	16.35	097655		
Fasteners: Double sided pressure sensitive tape, or screws (specify)	Gold (B2) w/ black lettering	16.35	009462		
Signs are individually packed in a polybag					

PULL

351L

Lettered Plastic Sign - PULL	Brown (W1) w/ white lettering	16.35	011623	-	5
Material: .125" thick plastic	Black (W2) w/ white lettering	16.35	016509		
Lettering: 3/4" Helvetica	Blue (W3) w/ white lettering	16.35	017433		
Size: 1" x 4-1/2"	Silver (B1) w/ black lettering	16.35	097656		
Fasteners: Double sided pressure sensitive tape, or screws (specify)	Gold (B2) w/ black lettering	16.35	-		
Signs are individually packed in a polybag					





352M						
Lettered Plastic Sign - MEN Material: .125" thick plastic Lettering: 3/4" Helvetica Size: 2-1/2" x 6" Fasteners: Double sided pressure sensitive tape, or screws (specify) Signs are individually packed in a polybag	Brown (W1) w/ white lettering	21.30	092362	-	5	
	Black (W2) w/ white lettering	21.30	089552			
	Blue (W3) w/ white lettering	21.30	089105			
	Silver (B1) w/ black lettering	21.30	092753			
	Gold (B2) w/ black lettering	21.30	098437			



352W						
Lettered Plastic Sign - WOMEN Material: .125" thick plastic Lettering: 3/4" Helvetica Size: 2-1/2" x 7" Fasteners: Double sided pressure sensitive tape, or screws (specify) Signs are individually packed in a polybag	Brown (W1) w/ white lettering	22.35	092363	-	5	
	Black (W2) w/ white lettering	22.35	089553			
	Blue (W3) w/ white lettering	22.35	089100			
	Silver (B1) w/ black lettering	22.35	092754			
	Gold (B2) w/ black lettering	22.35	-			



354A						
Lettered Plastic Sign - Restroom Material: .125" thick plastic Lettering: 3/4" Helvetica Size: 2" x 6" Fasteners: Double sided pressure sensitive tape Signs are individually packed in a polybag	Brown (W1) w/ white lettering	27.45	-	-	5	
	Black (W2) w/ white lettering	27.45	024414			
	Blue (W3) w/ white lettering	27.45	035530			







354B						
Lettered Plastic Sign - Restrooms Material: .125" thick plastic Lettering: 3/4" Helvetica Size: 2" x 6" Fasteners: Double sided pressure sensitive tape Signs are individually packed in a polybag	Brown (W1) w/ white lettering	27.45	-	-	5	
	Black (W2) w/ white lettering	27.45	049899			
	Blue (W3) w/ white lettering	27.45	025589			

1. Items with the price in **bold and red** are Quick Ship items and ship in 24 hours. Please use stock number when ordering. 2. U/M is each unless otherwise noted.



Trim & Auxiliary

	Description	Color	2021 List	Stock No.	Box Qty.	Case Qty.
	<p>364N Lasered International Symbol No Smoking Material: .125" thick plastic Size: 6" x 6" Fasteners: Pressure sensitive tape standard, or screws (specify) Signs are individually packed in a polybag</p>	Red (W4) w/ raised white symbol	32.90	089099	-	5
	<p>364S International Handicap Symbol Material: .0625" thick plastic Raised HANDICAP symbol Size: 3" x 3" Fasteners: Pressure sensitive tape standard, or screws (specify) Signs are individually packed in a polybag</p>	Blue (W3) w/ raised white symbol	19.65	099952	-	5
	<p>364M International Handicap Symbol Material: .0625" thick plastic Raised HANDICAP symbol Size: 4" x 4" Fasteners: Double sided pressure sensitive tape standard, or screws (specify) Signs are individually packed in a polybag</p>	Blue (W3) w/ raised white symbol	24.55	092522	-	5
	<p>364L International Handicap Symbol Material: .125" thick plastic 1/32" raised HANDICAP symbol Size: 6" x 6" Fasteners: Double sided pressure sensitive tape standard, or screws (specify) Signs are individually packed in a polybag</p>	Brown (W1) w/ raised white symbol Black (W2) w/ raised white symbol Blue (W3) w/ raised white symbol	33.85 33.85 33.85	017405 098102 089101	-	5





Description	Color	2021 List	Stock No.	Box Qty.	Case Qty.
365M ADA Tactile Signage - MEN Material: .125" thick plastic Grade 2 Braille Translation Size: 6" x 8" Fasteners: Double sided pressure sensitive tape Signs are individually packed in a polybag	Brown (W1) w/ raised white symbol	55.25	089102	-	5
	Black (W2) w/ raised white symbol	55.25	089097		
	Blue (W3) w/ raised white symbol	55.25	089098		



365W ADA Tactile Signage - WOMEN Material: .125" thick plastic Grade 2 Braille Translation Size: 6" x 8" Fasteners: Double sided pressure sensitive tape Signs are individually packed in a polybag	Brown (W1) w/ raised white symbol	58.10	089116	-	5
	Black (W2) w/ raised white symbol	58.10	089117		
	Blue (W3) w/ raised white symbol	58.10	089118		

325

366R ADA Tactile Signage Room Number Material: .125" thick plastic Grade 2 Braille Translation Size: 2-1/2" x 5" Fasteners: Double sided pressure sensitive tape Up to 3 characters included Add \$6.30 for a fourth character Signs are individually packed in a polybag	Brown (W1) w/ raised white symbol	27.70	113411	-	5
	Black (W2) w/ raised white symbol	27.70	008919		
	Blue (W3) w/ raised white symbol	27.70	008910		



366S ADA Tactile Signage - STAIRS Material: .125" thick plastic Grade 2 Braille Translation Size: 6" x 8" Fasteners: Double sided pressure sensitive tape Signs are individually packed in a polybag	Brown (W1) w/ raised white symbol	49.25	089112	-	5
	Black (W2) w/ raised white symbol	49.25	089113		
	Blue (W3) w/ raised white symbol	49.25	089115		



Trim & Auxiliary



Description	Color	2021 List	Stock No.	Box Qty.	Case Qty.
368E ADA Tactile Signage - EXIT Material: .125" thick plastic Grade 2 Braille Translation Size: 6" x 8" Fasteners: Double sided pressure sensitive tape Signs are individually packed in a polybag	Brown (W1) w/ raised white symbol	49.25	089119	-	5
	Black (W2) w/ raised white symbol	49.25	090296		
	Blue (W3) w/ raised white symbol	49.25	089088		



368M ADA Tactile Signage - MEN Material: .125" thick plastic Grade 2 Braille Translation Size: 6" x 8" Fasteners: Double sided pressure sensitive tape Signs are individually packed in a polybag	Brown (W1) w/ raised white symbol	58.35	089089	-	5
	Black (W2) w/ raised white symbol	58.35	089456		
	Blue (W3) w/ raised white symbol	58.35	089090		



368W ADA Tactile Signage - WOMEN Material: .125" thick plastic Grade 2 Braille Translation Size: 6" x 8" Fasteners: Double sided pressure sensitive tape Signs are individually packed in a polybag	Brown (W1) w/ raised white symbol	61.25	089092	-	5
	Black (W2) w/ raised white symbol	61.25	090033		
	Blue (W3) w/ raised white symbol	61.25	089093		





Description	Color	2021 List	Stock No.	Box Qty.	Case Qty.
368U ADA Tactile Signage - UNISEX Material: .125" thick plastic Grade 2 Braille Translation Size: 8" x 8" Fasteners: Double sided pressure sensitive tape Signs are individually packed in a polybag	Brown (W1) w/ raised white symbol	67.50	089719	-	5
	Black (W2) w/ raised white symbol	67.50	090224		
	Blue (W3) w/ raised white symbol	67.50	089091		



369L ADA Tactile Signage - ACCESS LEFT Material: .125" thick plastic Grade 2 Braille translation Size: 6" x 8" Fasteners: Double sided pressure sensitive tape Signs are individually packed in a polybag	Brown (W1) w/ raised white symbol	55.25	089094	-	5
	Black (W2) w/ raised white symbol	55.25	094727		
	Blue (W3) w/ raised white symbol	55.25	089095		



369R ADA Tactile Signage - ACCESS RIGHT Material: .125" thick plastic Grade 2 Braille translation Size: 6" x 8" Fasteners: Double sided pressure sensitive tape Signs are individually packed in a polybag	Brown (W1) w/ raised white symbol	55.25	089096	-	5
	Black (W2) w/ raised white symbol	55.25	094726		
	Blue (W3) w/ raised white symbol	55.25	089120		



370M ADA Tactile Signage - RESTROOM MEN Material: 9/16" thick plastic Grade 2 Braille Translation Size: 10-1/2" side Fasteners: Double sided pressure sensitive tape Signs are individually packed in a polybag	Blue (W3) w/ raised white symbol and lettering	33.85	089558	-	5
--	---	-------	--------	---	---



Trim & Auxiliary



Description	Color	2021 List	Stock No.	Box Qty.	Case Qty.
<p>370U ADA Tactile Signage - RESTROOM UNISEX Material: 9/16" thick plastic Grade 2 Braille Translation Size: 12" diameter Fasteners: Double sided pressure sensitive tape Signs are individually packed in a polybag</p>	Blue (W3) w/ raised white symbol and lettering	33.85	091565	-	5



<p>370W ADA Tactile Signage - RESTROOM WOMEN Material: 9/16" thick plastic Grade 2 Braille Translation Size: 12" diameter Fasteners: Double sided pressure sensitive tape Signs are individually packed in a polybag</p>	Blue (W3) w/ raised white symbol and lettering	33.85	089557	-	5
---	---	-------	--------	---	---





Description	Finish	2021 List	Stock No.	Box Qty.	Case Qty.
901P					
Coat Hook - Short single	US3	18.85	004095	1	-
Material: Brass	US26D	18.85	006028		
Diameter: 1"					
Projection: 1-1/4"					
Fasteners: #14 x 1-1/4" wood thread					



902P					
Coat Hook - Long Single	US3	26.45	004098	1	12
Material: Brass	US26D	26.45	011657		
Diameter: 1"					
Projection: 2-1/2"					
Fasteners: #14 x 1-1/4" wood thread					



903P					
Coat Hook - Long Double	US3	36.35	022247	1	12
Material: Brass	US26D	36.35	006364		
Diameter: 1"					
Projection: 2-1/2"					
Fasteners: #14 x 1-1/4" wood thread					



Trim & Auxiliary



Description	Finish	2021 List	Stock No.	Box Qty.	Case Qty.
910P					
Offset Mounting Vertical Pull					
Pull Diameter: 1-1/4"					
Fasteners: 3/8 - 16 FPHMS with finish washers					
Clearance: 1-1/2"					
Projection: 2-3/4"					
Length: 36"	US3	339.80	033176	1	12
CTC: 20"	US4	339.80	117797		
	US10	351.30	045611		
	US10B	351.30	075958		
	US15A	351.30	-		
	US26	351.30	013794		
	US26D	351.30	034212		
	US28	321.15	097652		
	US32D	257.00	034762		
Length: 72"	US3	408.70	199095	1	12
CTC: 56"	US4	408.70	-		
	US10	433.60	126115		
	US10B	433.60	001763		
	US15A	433.60	-		
	US26	433.60	013765		
	US26D	433.60	001766		
	US28	356.95	-		
	US32D	361.80	001767		



Description	Finish	2021 List	Stock No.	Box Qty.	Case Qty.
910B					
Offset Mounting Vertical Pull					
BTB Mounting					
Pull Diameter: 1-1/4"					
Clearance: 1-1/2"					
Projection: 2-3/4"					
Offset: 1-5/8"					
Length: 36"	US3	699.95	141396	1	12
CTC: 20"	US4	699.95	133716		
	US10	722.90	048451		
	US10B	722.90	043270		
	US15A	722.90	-		
	US26	722.90	-		
	US26D	722.90	048202		
	US28	662.70	167363		
	US32D	534.30	022333		
Length: 72"	US3	837.75	-	1	12
CTC: 56"	US4	837.75	193465		
	US10	887.45	099392		
	US10B	887.45	045049		
	US15A	887.45	-		
	US26	887.45	145909		
	US26D	887.45	095610		
	US28	734.30	043452		
	US32D	743.90	034310		



915P					
Straight Mounting Vertical Pull					
Pull Diameter: 1-1/4"					
Fasteners: 3/8 - 16 FPHMS with finish washers					
Length: 36"	US3	321.15	188905	1	12
CTC: 20"	US4	321.15	030973		
Clearance: 1-1/2"	US10	338.80	176190		
Projection: 2-3/4"	US10B	338.80	024013		
	US15A	338.80	142862		
	US26	338.80	114370		
	US26D	338.80	095117		
	US28	246.00	046879		
	US32D	280.50	022924		
Length: 72"	US3	374.25	-	1	12
CTC: 56"	US4	374.25	093132		
Clearance: 1-1/2"	US10	397.75	-		
Projection: 2-3/4"	US10B	397.75	047686		
	US15A	397.75	198625		
	US26	397.75	107976		
	US26D	397.75	076713		
	US28	321.15	147145		
	US32D	338.80	033534		



Trim & Auxiliary



Description	Finish	2021 List	Stock No.	Box Qty.	Case Qty.
915B					
915B					
Straight Mounting Vertical Pull					
BTB Mounting					
Pull Diameter: 1-1/4"					
Length: 36"	US3	662.70	083233	1	12
CTC: 20"	US4	662.70	045884		
Clearance: 1-1/2"	US10	698.00	127056		
Projection: 2-3/4"	US10B	698.00	045158		
	US15A	698.00	160970		
	US26	698.00	042157		
	US26D	698.00	099445		
	US28	512.45	086258		
	US32D	581.40	036192		
Length: 72"	US3	768.85	079229	1	12
CTC: 56"	US4	768.85	030970		
Projection: 2-3/4"	US10	815.75	169505		
	US10B	815.75	039857		
	US15A	815.75	-		
	US26	815.75	107975		
	US26D	815.75	075209		
	US28	662.70	091752		
	US32D	698.00	038310		
920P					
C-Shaped Pull	US3	408.70	175665	1	12
Projection: 2-1/4"	US4	408.70	023694		
Base Diameter: 1"	US10	467.05	068045		
Clearance: 1-3/4"	US10B	467.05	067513		
CTC: 8-1/2"	US15A	467.05	007029		
Fasteners: 3/8 - 16 FPHMS with finish washers	US26	467.05	150521		
	US26D	467.05	127861		
	US28	262.25	192274		
	US32D	397.75	006521		
920B					
C-Shaped Pull	US3	837.75	073762	1	12
BTB Mounting	US4	837.75	023825		
Projection: 2-1/4"	US10	954.45	180413		
Base Diameter: 1"	US10B	954.45	190801		
Clearance: 1-3/4"	US15A	954.45	-		
CTC: 8-1/2"	US26	954.45	160784		
	US26D	837.75	060870		
	US28	544.90	-092159		
	US32D	815.75	028143		





Description	Finish	2021 List	Stock No.	Box Qty.	Case Qty.
921P					
C-Shaped Pull	US3	817.25	-	1	12
Projection: 2-1/8"	US4	817.25	-		
Clearance: 1-1/2"	US10B	817.25	025579		
Offset: 8-1/2"	US15A	817.25	-		
CTC: 17-1/2"	US26	817.25	-		
Fasteners: 3/8 - 16 FPHMS with finish washers	US26D	817.25	059648		
	US32D	770.35	039887		
921B					
C-Shaped Pull	US3	1,654.85	-	1	12
BTB Mounting	US4	1,654.85	-		
Projection: 2-1/8"	US10B	1,654.85	179234		
Clearance: 1-1/2"	US15A	1,654.85	-		
Offset: 8-1/2"	US26	1,654.85	-		
CTC: 17-1/2"	US26D	1,654.85	092126		
	US32D	1,561.00	021628		
922P					
C-Shaped Pull Continuous					
Pull Diameter: 1"					
Projection: 2-1/2"					
Fasteners: 3/8 - 16 FPHMS with finish washers					
Clearance: 1-1/2"					
CTC: 10"	US3	255.10	052183	1	12
	US4	255.10	050741		
	US10	310.15	-		
	US10B	310.15	076741		
	US15A	310.15	-		
	US26	310.15	-		
	US26D	310.15	033046		
	US28	164.25	-		
	US32D	246.00	040459		
CTC: 12"	US3	292.95	-	1	12
	US4	292.95	-		
	US10	327.35	029399		
	US10B	327.35	029237		
	US15A	327.35	-		
	US26	327.35	031122		
	US26D	327.35	033048		
	US28	187.15	097273		
	US32D	269.05	017908		

1. Items with the price in **bold and red** are Quick Ship items and ship in 24 hours.
Please use stock number when ordering. 2. U/M is each unless otherwise noted.



Trim & Auxiliary



Description	Finish	2021 List	Stock No.	Box Qty.	Case Qty.
922B					
C-Shaped Pull Continuous					
BTB Mounting					
Pull Diameter: 1"					
Projection: 2-1/2"					
Clearance: 1-1/2"					
CTC: 10"	US3	530.55	043544	1	12
	US4	530.55	054798		
	US10	640.55	-		
	US10B	640.55	076740		
	US15A	640.55	-		
	US26	640.55	038676		
	US26D	640.55	028387		
	US28	348.80	047322		
	US32D	512.45	031463		
CTC: 12"	US3	606.20	025373	1	12
	US4	606.20	049391		
	US10	675.05	-		
	US10B	675.05	031604		
	US15A	675.05	-		
	US26	675.05	-		
	US26D	675.05	054764		
	US28	394.75	-		
	US32D	558.40	032177		



923P					
C-Shaped Pull Flanged					
Pull Diameter: 1"					
Projection: 2-3/4"					
Clearance: 1-3/4"					
Base Diameter: 3/4"					
Fasteners: 3/8 - 16 FPHMS with finish washers					
CTC: 10"	US3	291.95	-	1	12
	US4	291.95	-		
	US10	309.15	-		
	US10B	309.15	042387		
	US15A	309.15	-		
	US26	309.15	-		
	US26D	309.15	-		
	US28	163.70	042579		
	US32D	245.10	107215		
CTC: 12"	US3	314.90	028028	1	12
	US4	314.90	041357		
	US10	327.35	-		
	US10B	327.35	086167		
	US15A	327.35	-		
	US26	327.35	007281		
	US26D	327.35	059492		
	US28	188.60	-		
	US32D	269.05	043111		



Description	Finish	2021 List	Stock No.	Box Qty.	Case Qty.
923B					
C-Shaped Pull Flanged					
BTB Mounting					
Pull Diameter: 1"					
Projection: 2-3/4"					
Clearance: 1-3/4"					
Base Diameter: 3/4"					
CTC: 10"	US3	604.25	-	1	12
	US4	604.25	-		
	US10	638.60	-		
	US10B	638.60	-		
	US15A	638.60	-		
	US26	638.60	-		
	US26D	638.60	027475		
	US28	347.80	087162		
	US32D	510.50	097112		
CTC: 12"	US3	650.20	033306	1	12
	US4	650.20	-		
	US10	675.05	-		
	US10B	675.05	-		
	US15A	675.05	-		
	US26	675.05	-		
	US26D	675.05	100390		
	US28	397.55	-		
	US32D	558.40	032950		



924P					
C-Shaped Pull	US3	361.80	-	1	12
O/A Height: 15"	US4	361.80	-		
Projection: 2-1/2"	US10B	397.75	039224		
Clearance: 1-1/2"	US15A	397.75	-		
Offset: 6-1/2"	US26	397.75	170355		
Fasteners: 3/8 -16 FPHMS with finish washers	US26D	361.80	033435		
	US32D	526.35	091516		



924B					
C-Shaped Pull	US3	743.90	-	1	12
BTB Mounting	US4	743.90	094302		
O/A Height: 15"	US10B	815.75	027198		
Projection: 2-1/2"	US15A	815.75	113505		
Clearance: 1-1/2"	US26	815.75	-		
Offset: 6-1/2"	US26D	743.90	034830		
	US32D	1,073.00	073072		

1. Items with the price in **bold and red** are Quick Ship items and ship in 24 hours.
Please use stock number when ordering. 2. U/M is each unless otherwise noted.



Trim & Auxiliary



Description	Finish	2021 List	Stock No.	Box Qty.	Case Qty.
925P					
C-Shaped Pull					
Pull Diameter: 1-1/4"					
Fasteners: 3/8 - 16 FPHMS with finish washers					
6-1/2"	US3	321.15	-	1	12
	US4	321.15	-		
	US10	338.80	-		
	US10B	338.80	-		
	US15A	338.80	-		
	US26	338.80	-		
	US26D	338.80	-		
	US28	232.55	-		
	US32D	262.25	-		
8-1/2"	US3	327.35	-	1	12
	US4	327.35	-		
	US10	350.30	-		
	US10B	350.30	-		
	US15A	350.30	-		
	US26	350.30	116438		
	US26D	350.30	-		
	US28	245.10	-		
	US32D	280.50	093311		
12-1/2"	US3	385.70	-	1	12
	US4	385.70	-		
	US10	408.70	-		
	US10B	408.70	095383		
	US15A	408.70	-		
	US26	408.70	-		
	US26D	408.70	-		
	US28	280.50	-		
	US32D	374.25	019494		



Description	Finish	2021 List	Stock No.	Box Qty.	Case Qty.
925B					
C-Shaped Pull					
BTB Mounting					
Pull Diameter: 1-1/4"					
6-1/2"	US3	662.70	-	1	12
	US4	662.70	-		
	US10	698.00	-		
	US10B	698.00	-		
	US15A	698.00	-		
	US26	698.00	-		
	US26D	650.20	-		
	US28	698.00	-		
	US32D	544.90	032601		
8-1/2"	US3	675.05	-	1	12
	US4	675.05	-		
	US10	720.95	-		
	US10B	720.95	-		
	US15A	720.95	-		
	US26	720.95	-		
	US26D	720.95	-		
	US28	510.50	-		
	US32D	581.40	-		
12-1/2"	US3	791.80	084531	1	12
	US4	791.80	-		
	US10	837.75	-		
	US10B	837.75	-		
	US15A	837.75	-		
	US26	837.75	-		
	US26D	837.75	-		
	US28	581.40	-		
	US32D	768.85	-		



926P					
Curved Shaped Pull					
Base Diameter: 1-1/4"	US3	374.25	-	1	12
Projection: 3"	US4	374.25	-		
Clearance: 1-13/16"	US10B	420.20	000085		
Offset: 5-9/32"					
CTC: 12"					
Pull Diameter: 1-3/16"					
Fasteners: 3/8 - 16 FPHMS with finish washers					



926B					
Curved Shaped Pull	US3	768.85	-	1	12
BTB Mounting	US4	768.85	-		
Base Diameter: 1-1/4"	US10B	860.70	-		
Projection: 3"					
Clearance: 1-13/16"					
Offset: 5-9/32"					
CTC: 12"					
Pull Diameter: 1-3/16"					

1. Items with the price in **bold and red** are Quick Ship items and ship in 24 hours.
Please use stock number when ordering. 2. U/M is each unless otherwise noted.



Trim & Auxiliary



Description	Finish	2021 List	Stock No.	Box Qty.	Case Qty.
930P					
90° Pull					
Fasteners: 3/8 - 16 FPHMS with finish washers					
Projection: 3"					
Clearance: 1-3/4"					
10" x 10", 14-5/32 CTC	US3	246.00	-	1	12
	US4	246.00	-		
	US10B	280.50	-		
	US15A	280.50	-		
	US26	280.50	-		
	US26D	280.50	-		
	US28	151.25	-		
	US32D	233.55	041518		
12" x 12" 16-31/32" CTC	US3	263.20	-	1	12
	US4	263.20	-		
	US10B	303.95	-		
	US15A	303.95	-		
	US26	257.00	-		
	US26D	257.00	-		
	US28	164.25	-		
	US32D	246.00	-		



930B					
90° Pull					
BTB Mounting					
Projection: 3"; Clearance: 1-3/4"					
10" x 10", 14-5/32 CTC	US3	512.45	078218	1	12
	US4	512.45	-		
	US10B	581.40	-		
	US15A	581.40	-		
	US26	581.40	-		
	US26D	581.40	-		
	US28	322.90	-		
	US32D	487.45	102505		
12" x 12" 16-31/32" CTC	US3	546.85	-	1	12
	US4	546.85	-		
	US10B	628.20	-		
	US15A	628.20	-		
	US26	534.30	-		
	US26D	534.30	-		
	US28	348.80	-		
	US32D	512.45	048305		



932P					
S-Shaped Pull	US3	490.45	-	1	12
Projection: 3"	US4	490.45	-		
Clearance: 2"	US10B	537.40	-		
Pull Diameter: 1"	US15A	537.40	-		
Fasteners: 3/8 - 16 FPHMS with finish washers	US26	537.40	-		
	US26D	490.45	-		
	US28	397.75	-		
	US32D	479.50	048039		

Description	Finish	2021 List	Stock No.	Box Qty.	Case Qty.
932B					
S-Shaped Pull	US26D	1,661.40	-	1	12
BTB Mounting	US32D	1,306.05	-		
Projection: 3"					
Clearance: 2"					
Pull Diameter: 1"					
Fasteners: 3/8 - 16 FPHMS with finish washers					
Note: must specify handing					
<hr/>					
933P					
Colonial Style Door Pull	US3	93.90	021632	1	12
Projection: 2-3/16"	US4	82.45	025560		
Pull Diameter: 1"	US10B	111.10	041459		
Base Diameter: 15/16"	US26	111.10	140775		
Fasteners: 3/8 - 16 FPHMS with finish washers					
Clearance: 1-3/16"					
CTC: 6"					
<hr/>					
933B					
Colonial Style Door Pull	US3	208.15	-	1	12
BTB Mounting	US4	185.30	-		
Projection: 2-3/16"	US10B	242.55	020879		
Pull Diameter: 1"	US26	242.55	-		
Base Diameter: 15/16"					
Clearance: 1-3/16"					
CTC: 6"					
<hr/>					
934P					
Offset Pull					
Projection: 3-1/8"					
Pull Diameter: 1-1/4"					
Base Diameter: 1"					
Clearance: 1-7/8"					
Fasteners: 3/8 - 16 FPHMS with finish washers					
CTC: 12"	US3	338.80	015408	1	12
	US4	338.80	055245		
	US10B	338.80	018229		
	US15A	338.80	022244		
	US26	338.80	024963		
	US26D	338.80	009614		
	US28	334.95	-		
	US32D	408.70	087258		
CTC: 16"	US3	350.75	-	1	12
	US4	350.75	-		
	US10B	350.75	018887		
	US15A	350.75	-		
	US26	350.75	-		
	US26D	350.75	081586		
	US28	344.60	-		
	US32D	422.95	055788		
CTC: 18"	US3	384.25	-	1	12
	US4	384.25	-		
	US10B	384.25	018219		
	US15A	384.25	-		
	US26	384.25	-		
	US26D	384.25	-		
	US28	378.00	-		
	US32D	463.20	089638		



1. Items with the price in **bold and red** are Quick Ship items and ship in 24 hours.
Please use stock number when ordering. 2. U/M is each unless otherwise noted.



Trim & Auxiliary



Description	Finish	2021 List	Stock No.	Box Qty.	Case Qty.
934B					
Offset Pull					
BTB Mounting					
Base Diameter: 1"					
Projection: 3-1/8"					
Clearance: 1-7/8"					
Pull Diameter: 1-1/4"					
CTC: 12"	US3	698.00	-	1	12
	US4	698.00	038443		
	US10B	698.00	042701		
	US15A	698.00	-		
	US26	698.00	194305		
	US26D	698.00	-		
	US28	690.30	-		
	US32D	837.75	120341		
CTC: 16"	US3	721.95	-	1	12
	US4	721.95	-		
	US10B	721.95	-		
	US15A	721.95	-		
	US26	721.95	-		
	US26D	721.95	-		
	US28	709.50	-		
	US32D	866.35	-		
CTC: 18"	US3	788.90	-	1	12
	US4	788.90	-		
	US10B	788.90	-		
	US15A	788.90	-		
	US26	788.90	-		
	US26D	788.90	-		
	US28	776.35	-		
	US32D	946.65	-		



936P					
Coat Hook Single/Angled					
Material: Brass					
Base Diameter: 1-15/16"	US3	49.85	021976	1	12
Hook Diameter: 11/16"	US26D	49.85	009820		
Projection: 3-5/16"					



937P					
Coat Hook	US3	51.10	028259	1	12
Material: Brass	US26D	51.10	009821		
Projection: 3-3/4" top hook; 2-1/2" bottom hook					



Description	Finish	2021 List	Stock No.	Box Qty.	Case Qty.
940P Double Coat Hook Material: Brass Top Projection: 3-15/16" Bottom Projection: 2-1/8" Thickness: 1/4" Fasteners: #10 x 1" FPHWS	US3 US26D	18.65 18.65	028110 022327	1	12



941P Single Coat Hook Material: Brass Projection: 2-1/8" Thickness: 1/4" Fasteners: #10 x 1" FPHWS	US3 US26D	17.35 17.35	043274 017192	1	12
--	--------------	----------------	------------------	---	----



945P Double Coat Hook - Surface mounting Material: Brass O/A Height: 5-1/2" Projection: 3-5/16" Fasteners: #10 x 1" FPHWS w/ anchors	US3 US26D	47.35 47.35	041591 -	1	12
--	--------------	----------------	-------------	---	----



946P Double Coat Hook w/ Concealed Mounting Material: Brass O/A Height: 5-1/2" Projection: 3-11/16" Fasteners: #10 x 1" FPHWS w/ anchors	US3 US26D	90.25 90.25	035563 016502	1	12
--	--------------	----------------	------------------	---	----







951P Double Coat Hook/Straight Material: Brass O/A Height: 5-3/4" Projection: 2-3/4"	US3 US26D	90.25 90.25	009815 007030	1	12
---	--------------	----------------	------------------	---	----

1. Items with the price in **bold and red** are Quick Ship items and ship in 24 hours.
Please use stock number when ordering. 2. U/M is each unless otherwise noted.



Trim & Auxiliary

	Description	Finish	2021 List	Stock No.	Box Qty.	Case Qty.
	952P					
	Single Coat Hook/Straight Material: Brass O/A Height: 2-13/16" Projection: 2-7/32"	US3 US26D	72.40 72.40	009818 009816	1	12
	956P					
	Double Coat Hook/Angled Material: Brass O/A Height: 5-11/16" Projection: 3-23/32"	US3 US4 US26D	87.85 87.85 87.85	022248 190569 009823	1	12
	957P					
	Coat Hook Materials: Brass Projection: 1-3/4" Base Diameter: 3/4" Fasteners: #10 x 1" wood thread	US3 US26D	22.20 22.20	038315 010738	1	12
	960P					
	Square Tip Pull	US3	443.55	009259	1	12
	O/A Height: 16"	US4	443.55	038157		
	Base Diameter: 1-1/4"	US10B	443.55	011621		
	Pull Diameter: 1"	US15A	443.55	013611		
	Projection: 3-1/4"	US26	443.55	020471		
Clearance: 1-3/4"	US26D	443.55	015493			
Fasteners: 3/8 - 16 FPHMS with finish washers CTC: 12"						
	960B					
	Square Tip Pull	US3	907.55	-	1	12
	BTB Mounting	US4	907.55	044725		
	O/A Height: 16"	US10B	907.55	075667		
	Base Diameter: 1-1/4"	US15A	907.55	-		
	Pull Diameter: 1"	US26	907.55	-		
Projection: 3-1/4"	US26D	907.55	069324			
Clearance: 1-3/4"						
CTC: 12"						



Description	Finish	2021 List	Stock No.	Box Qty.	Case Qty.
961P					
Steeple Tip Pull	US3	420.20	-	1	12
O/A Height: 16-5/16"	US4	420.20	-		
Base Diameter: 2"	US10B	420.20	015679		
Pull Diameter: 1"	US15A	420.20	009262		
Projection: 3"	US26	420.20	-		
Clearance: 1-3/4"	US26D	420.20	015011		
Fasteners: 3/8 - 16 FPHMS with finish washers					
CTC: 12"					



961B					
Steeple Tip Pull	US3	860.70	026830	1	12
BTB Mounting	US4	860.70	074979		
O/A Height: 16-5/16"	US10B	860.70	078830		
Base Diameter: 2"	US15A	860.70	-		
Pull Diameter: 1"	US26	860.70	-		
Projection: 3"	US26D	860.70	092283		
Clearance: 1-3/4"					
CTC: 12"					



962P					
Acorn Tip Pull	US3	420.20	007923	1	12
O/A Height: 16-5/16"	US4	420.20	011372		
Base Diameter: 2"	US10B	420.20	078830		
Pull Diameter: 1"	US15A	420.20	000573		
Projection: 3"	US26	420.20	009264		
Clearance: 1-7/8"	US26D	420.20	-		
Fasteners: 3/8 - 16 FPHMS with finish washers					
CTC: 12"					

1. Items with the price in **bold and red** are Quick Ship items and ship in 24 hours.
Please use stock number when ordering. 2. U/M is each unless otherwise noted.



Trim & Auxiliary



Description	Finish	2021 List	Stock No.	Box Qty.	Case Qty.
963P					
Acorn Tip Pull - Offset					
Pull Diameter: 1"					
Fasteners: 3/8 - 16 FPHMS with finish washers					
CTC: 12"	US3	455.55	090673	1	12
	US4	438.35	185396		
	US10B	455.55	093281		
	US15A	455.55	064105		
	US26	455.55	-		
	US26D	455.55	182665		
CTC: 16"	US3	560.90	-	1	12
	US4	531.20	-		
	US10B	560.90	125026		
	US15A	560.90	-		
	US26	560.90	-		
	US26D	560.90	-		
CTC: 18"	US3	565.60	-	1	12
	US4	454.60	080532		
	US10B	570.00	099640		
	US15A	570.00	-		
	US26	570.00	-		
	US26D	570.00	058839		
CTC: 24"	US3	592.35	-	1	12
	US4	562.10	-		
	US10B	592.35	049909		
	US15A	592.35	-		
	US26	592.35	-		
	US26D	592.35	-		
CTC: 30"	US3	615.85	-	1	12
	US4	588.10	-		
	US10B	615.85	049907		
	US15A	615.85	-		
	US26	615.85	-		
	US26D	615.85	-		



967P					
Curved Pull					
O/A Height: 20-1/2"					
Clearance: 3-9/16"					
Projection: 5-9/16"					
Specify handing					
Fasteners: 3/8 - 16 FPHMS with finish washers					
	US3	1,109.05	024430	1	12
	US4	1,109.05	009305		
	US10B	1,283.30	016556		
	US15A	1,283.30	-		
	US26	1,283.30	-		
	US26D	1,283.30	008614		



Description	Finish	2021 List	Case Qty.	Over 36"
970P				
970P	US3	508.05	12	8.00
Push/Pull Set	US4	508.05		8.00
Base Diameter: 1"	US10	508.05		8.00
Pull Projection: 3"	US10B	508.05		8.00
Pull Clearance: 2"	US15A	508.05		8.00
CTC Length: 16-3/4"	US26	508.05		8.00
Push clearance: 1-3/4"	US26D	508.05		8.00
Push projection: 2-3/4"	US32D	490.30		13.40
Fasteners: Type 3 Mounting				
Handing Required				
Additional Bars by Quotation				
*Add per linear inch or fraction thereof				



Description	Finish	2021 List	Stock No.	Box Qty.	Case Qty.
974P					
Door Pull					
Pull Diameter: 1" (25 mm)					
Base Diameter: 2" (51 mm)					
Projection: 2-1/2"					
Fasteners: 3/8 - 16 FPHMS with finish washers					
CTC: 12"	US3	504.40	096812	1	12
	US4	504.40	-		
	US10B	504.40	077525		
	US26	504.40	178427		
	US26D	504.40	067183		
	US32D	504.40	090347		
CTC: 18"	US3	524.95	187112	1	12
	US4	524.95	-		
	US10B	524.95	124873		
	US26	524.95	-		
	US26D	524.95	077942		
	US32D	524.95	008568		
CTC: 24"	US3	548.35	-	1	12
	US4	548.35	057982		
	US10B	548.35	-		
	US26	548.35	-		
	US26D	548.35	118329		
	US32D	548.35	065323		
CTC: 30"	US3	571.80	-	1	12
	US4	571.80	067792		
	US10B	571.80	178035		
	US26	571.80	-		
	US26D	571.80	-		
	US32D	571.80	181045		
CTC: 36"	US3	571.80	-	1	12
	US4	571.80	057981		
	US10B	571.80	199053		
	US26	571.80	-		
	US26D	571.80	117957		
	US32D	571.80	138337		

1. Items with the price in **bold and red** are Quick Ship items and ship in 24 hours.
Please use stock number when ordering. 2. U/M is each unless otherwise noted.



Trim & Auxiliary



Description	Finish	2021 List	Stock No.	Box Qty.	Case Qty.
974B					
Door Pull					
BTB Mounting					
Pull Diameter: 1" (25 mm)					
Base Diameter: 2" (51 mm)					
Projection: 2-1/2"					
Fasteners: 3/8 - 16 FPHMS with finish washers					
CTC: 12"	US3	1,029.10	160776	1	12
	US4	1,029.10	181357		
	US10B	1,029.10	094407		
	US26	1,029.10	-		
	US26D	1,029.10	012146		
	US32D	1,029.10	094083		
CTC: 18"	US3	1,070.20	-	1	12
	US4	1,070.20	-		
	US10B	1,070.20	-		
	US26	1,070.20	190940		
	US26D	1,070.20	091914		
	US32D	1,070.20	080540		
CTC: 24"	US3	1,117.15	-	1	12
	US4	1,117.15	-		
	US10B	1,117.15	031371		
	US26	1,117.15	-		
	US26D	1,117.15	-		
	US32D	1,117.15	080541		
CTC: 30"	US3	1,163.95	-	1	12
	US4	1,163.95	067788		
	US10B	1,163.95	-		
	US26	1,163.95	-		
	US26D	1,163.95	107473		
	US32D	1,163.95	124943		
CTC: 36"	US3	1,163.95	162089	1	12
	US4	1,163.95	-		
	US10B	1,163.95	-		
	US26	1,163.95	-		
	US26D	1,163.95	-		
	US32D	1,163.95	091943		



Description	Finish	2021 List	Stock No.	Box Qty.	Case Qty.
975P					
Vertical Pull					
Pull Diameter: 1"					
Projection: 2-3/4"					
Fasteners: 3/8 - 16 FPHMS with finish washers					
Length: 36"					
CTC: 20"					
	US3	276.65	-	1	12
	US4	276.65	-		
	US10	276.65	-		
	US10B	276.65	042466		
	US15A	276.65	012591		
	US26	276.65	050339		
	US26D	276.65	012278		
	US32D	276.65	010891		
<hr/>					
Length: 72"					
CTC: 56"					
	US3	397.75	119290	1	12
	US4	397.75	074642		
	US10	397.75	070431		
	US10B	397.75	022804		
	US15A	397.75	012601		
	US26	397.75	030738		
	US26D	397.75	029768		
	US32D	397.75	028382		



975B					
Vertical Pull					
BTB Mounting					
Pull Diameter: 1"					
Projection: 2-3/4"					
Length: 36"					
CTC: 20"					
	US3	573.70	101090	1	12
	US4	573.70	198942		
	US10	573.70	099259		
	US10B	573.70	025610		
	US15A	573.70	-		
	US26	573.70	030737		
	US26D	573.70	021401		
	US32D	573.70	028442		
<hr/>					
Length: 72"					
CTC: 56"					
	US3	815.75	-	1	12
	US4	815.75	-		
	US10	815.75	-		
	US10B	815.75	021488		
	US15A	815.75	-		
	US26	815.75	030738		
	US26D	815.75	021402		
	US32D	815.75	021547		

1. Items with the price in **bold and red** are Quick Ship items and ship in 24 hours.
Please use stock number when ordering. 2. U/M is each unless otherwise noted.



Trim & Auxiliary



Description	Finish	2021 List	Stock No.	Box Qty.	Case Qty.
976P Door Pull Offset Overall: 29-1/2"; CTC: 19-13/16" Base Diameter: 1-1/4" Pull Diameter: 1-1/4" Projection: 5-3/8" Clearance: 4-1/8" Offset: 1-3/4" Fasteners: 3/8 - 16 FPHMS with finish washers	US32D	611.55	088820	1	12



976B Door Pull Offset Overall: 29-1/2"; CTC: 19-13/16" BTB Mounting Base Diameter: 1-1/4" Pull Diameter: 1-1/4" Projection: 5-3/8" Clearance: 4-1/8" Offset: 1-3/4"	US32D	1,243.45	062051	1	12
--	-------	----------	--------	---	----



980P Segment Shape - Straight Fasteners: 3/8 - 16 FPHMS with finish washers					
CTC: 9"	US3	184.80	-	1	12
	US4	184.80	-		
	US10B	184.80	012840		
	US15A	184.80	076601		
	US26	184.80	-		
	US26D	184.80	-		
	US32D	184.80	027302		
CTC: 12"	US3	184.80	-	1	12
	US4	184.80	095352		
	US10B	184.80	083262		
	US15A	184.80	-		
	US26	184.80	014517		
	US26D	184.80	049530		
	US32D	184.80	031717		
CTC: 18"	US3	204.80	-	1	12
	US4	204.80	084595		
	US10B	204.80	012799		
	US15A	204.80	-		
	US26	204.80	-		
	US26D	204.80	057861		
	US32D	204.80	016625		
CTC: 24"	US3	204.80	-	1	12
	US4	204.80	-		
	US10B	204.80	065896		
	US15A	204.80	121326		
	US26	204.80	-		
	US26D	204.80	036275		
	US32D	204.80	024698		

Description	Finish	2021 List	Stock No.	Box Qty.	Case Qty.
980B					
Segment Shape - Straight					
BTB Mounting					
CTC: 9"					
	US3	389.90	-	1	12
	US4	389.90	-		
	US10B	389.90	116185		
	US15A	389.90	114829		
	US26	389.90	-		
	US26D	389.90	-		
	US32D	389.90	083497		
CTC: 12"					
	US3	389.90	-	1	12
	US4	389.90	-		
	US10B	389.90	101513		
	US15A	389.90	-		
	US26	389.90	-		
	US26D	389.90	039876		
	US32D	389.90	032307		
CTC: 18"					
	US3	429.95	-	1	12
	US4	429.95	-		
	US10B	429.95	-		
	US15A	429.95	-		
	US26	429.95	-		
	US26D	429.95	044015		
	US32D	429.95	022336		
CTC: 24"					
	US3	429.95	-	1	12
	US4	429.95	-		
	US10B	429.95	017774		
	US15A	429.95	-		
	US26	429.95	-		
	US26D	429.95	-		
	US32D	429.95	-		

1. Items with the price in **bold and red** are Quick Ship items and ship in 24 hours.
Please use stock number when ordering. 2. U/M is each unless otherwise noted.



Trim & Auxiliary



Description	Finish	2021 List	Stock No.	Box Qty.	Case Qty.
981P					
Segment Shape - Offset Pull					
Projection: 2-3/8"					
Fasteners: 3/8 - 16 FPHMS with finish washers					
CTC: 9"	US3	210.10	-	1	12
	US4	210.10	-		
	US10B	210.10	-		
	US15A	210.10	-		
	US26	210.10	-		
	US26D	210.10	-		
	US32D	210.10	046757		
CTC: 12"	US3	218.25	-	1	12
	US4	218.25	-		
	US10B	218.25	-		
	US15A	218.25	-		
	US26	218.25	-		
	US26D	218.25	-		
	US32D	218.25	-		
CTC: 18"	US3	246.00	-	1	12
	US4	246.00	-		
	US10B	246.00	-		
	US15A	246.00	-		
	US26	246.00	-		
	US26D	246.00	010525		
	US32D	246.00	015619		
CTC: 24"	US3	303.95	-	1	12
	US4	303.95	-		
	US10B	303.95	-		
	US15A	303.95	-		
	US26	303.95	-		
	US26D	303.95	010526		
	US32D	303.95	033975		

Description	Finish	2021 List	Stock No.	Box Qty.	Case Qty.
981B					
Segment Shape - Offset Pull					
BTB Mounting					
Projection: 2-3/8"					
CTC: 9"	US3	440.60	-	1	12
	US4	440.60	-		
	US10B	440.60	-		
	US15A	440.60	-		
	US26	440.60	-		
	US26D	440.60	-		
	US32D	440.60	-		
CTC: 12"	US3	456.80	027231	1	12
	US4	456.80	-		
	US10B	456.80	-		
	US15A	456.80	-		
	US26	456.80	-		
	US26D	456.80	-		
	US32D	456.80	-		
CTC: 18"	US3	512.45	-	1	12
	US4	512.45	050164		
	US10B	512.45	001599		
	US15A	512.45	188633		
	US26	512.45	022355		
	US26D	512.45	097705		
	US32D	512.45	028505		
CTC: 24"	US3	628.20	-	1	12
	US4	628.20	-		
	US10B	628.20	085243		
	US15A	628.20	-		
	US26	628.20	049864		
	US26D	628.20	027598		
	US32D	628.20	031349		
982P					
Straight Pull					
Base Diameter: 1-5/16"					
Projection: 3-1/8"	US3	455.55	-	1	12
Clearance: 1-13/16"	US4	455.55	-		
CTC: 20"	US10B	490.45	-		
Fasteners: 3/8 - 16 FPHMS with	US15A	490.45	-		
finish washers	US26	490.45	-		
	US26D	490.45	058080		
	US32D	560.90	080284		
982B					
Straight Pull	US3	931.50	-	1	12
BTB Mounting	US4	931.50	-		
Base Diameter: 1-5/16"	US10B	1,001.30	172423		
Projection: 3-1/8"	US15A	1,001.30	-		
Clearance: 1-13/16"	US26	1,001.30	-		
CTC: 20"	US26D	1,001.30	009491		
	US32D	1,142.10	091255		

1. Items with the price in **bold and red** are Quick Ship items and ship in 24 hours.
Please use stock number when ordering. 2. U/M is each unless otherwise noted.



Trim & Auxiliary



Description	Finish	2021 List	Stock No.	Box Qty.	Case Qty.
983P					
Curved Pull					
Base Diameter: 14-1/4"					
Projection: 3-1/8"					
Clearance: 1-7/8"					
Fasteners: 3/8 - 16 FPHMS with finish washers					
Specify handing					
Left Hand	US3	455.55	-	1	12
	US4	455.55	-		
	US10B	490.45	099179		
	US15A	490.45	-		
	US26	490.45	-		
	US26D	490.45	186027		
	US32D	560.90	083105		
Right Hand	US3	455.55	-	1	12
	US4	455.55	-		
	US10B	490.45	140022		
	US15A	490.45	-		
	US26	490.45	-		
	US26D	490.45	105909		
	US32D	560.90	083106		



983B					
Curved Pull					
BTB Mounting					
Base Diameter: 14-1/4"					
Projection: 3-1/8"					
Clearance: 1-7/8"					
Specify handing					
Left Hand	US3	931.50	-	1	12
	US4	931.50	-		
	US10B	1,001.30	044345		
	US15A	1,001.30	-		
	US26	1,001.30	-		
	US26D	1,001.30	065560		
	US32D	1,142.10	-		
Right Hand	US3	931.50	-	1	12
	US4	931.50	-		
	US10B	1,001.30	044347		
	US15A	1,001.30	-		
	US26	1,001.30	-		
	US26D	1,001.30	-		
	US32D	1,142.10	085557		



Description	Finish	2021 List	Stock No.	Box Qty.	Case Qty.
984P					
Curved Pull					
Projection: 3"					
Fasteners: 3/8 - 16 FPHMS with finish washers					
CTC: 12"	US3	303.95	-	1	12
	US4	303.95	-		
	US10B	303.95	-		
	US15A	303.95	-		
	US26	303.95	060382		
	US26D	303.95	-		
	US32D	379.05	078894		
CTC: 20"	US3	453.65	-	1	12
	US4	453.65	-		
	US10B	453.65	-		
	US15A	453.65	-		
	US26	453.65	-		
	US26D	453.65	014652		
	US32D	586.15	082549		



984B					
Curved Pull					
BTB Mounting					
Projection: 3"					
CTC: 12"	US3	628.20	-	1	12
	US4	628.20	-		
	US10B	628.20	033349		
	US15A	628.20	-		
	US26	628.20	-		
	US26D	628.20	-		
	US32D	778.40	047511		
CTC: 20"	US3	927.70	-	1	12
	US4	927.70	-		
	US10B	927.70	-		
	US15A	927.70	-		
	US26	927.70	-		
	US26D	927.70	-		
	US32D	1,192.75	-		



985P					
Curved Pull	US3	257.00	-	1	12
O/A Height: 14"	US4	257.00	-		
Base Diameter: 2"	US10B	292.95	039255		
Projection: 3"	US15A	292.95	-		
Clearance: 1-9/16"	US26	292.95	-		
Offset: 1-5/8"	US26D	257.00	055021		
CTC: 12"	US32D	374.25	194538		
Fasteners: 3/8 - 16 FPHMS with finish washers					

1. Items with the price in **bold and red** are Quick Ship items and ship in 24 hours.
Please use stock number when ordering. 2. U/M is each unless otherwise noted.



Trim & Auxiliary



Description	Finish	2021 List	Stock No.	Box Qty.	Case Qty.
985B					
Curved Pull	US3	534.30	-	1	12
BTB Mounting	US4	534.30	-		
O/A Height: 14"	US10B	606.20	-		
Base Diameter: 2"	US15A	606.20	-		
Projection: 3"	US26	606.20	030739		
Offset: 1-5/8"	US26D	534.30			
Clearance: 1-9/16"	US32D	768.85	063938		
CTC: 12"					



986P					
Curved Pull	US3	642.15	-	1	12
O/A Height: 22"	US4	642.15	-		
Pull Diameter: 1-1/4"	US10B	642.15	014868		
Base Diameter: 2"	US15A	642.15	021822		
Projection: 3-7/8"	US26	642.15	-		
Offset: 3"	US26D	642.15	-		
Clearance: 2-5/8"	US26D	642.15	-		
CTC: 20"	US32D	583.75	-		
Fasteners: 3/8 - 16 FPHMS with finish washers					



986B					
Curved Pull	US3	1,304.65	-	1	12
BTB Mounting	US4	1,304.65	032338		
O/A Height: 22"	US10B	1,304.65	-		
Pull Diameter: 1-1/4"	US15A	1,304.65	023943		
Base Diameter: 2"	US26	1,304.65	-		
Projection: 3-7/8"	US26D	1,304.65	-		
Offset: 3"	US26D	1,304.65	-		
Clearance: 2-5/8"	US32D	1,187.85	-		
CTC: 20"					



987P					
Double Curved Pull	US3	560.90	-	1	12
Base Diameter: 1-1/4"	US4	560.90	-		
Projection: 3"	US10B	560.90	038422		
Clearance: 2"	US15A	560.90	014457		
CTC: 20"	US26	560.90	09304		
Fasteners: 3/8 - 16 FPHMS with finish washers	US26D	560.90	-		
	US32D	548.35	092052		



987B					
Double Curved Pull	US3	1,142.10	-	1	12
BTB Mounting	US4	1,142.10	-		
Base Diameter: 1-1/4"	US10B	1,142.10	062018		
Projection: 3"	US15A	1,142.10	080604		
Clearance: 2"	US26	1,142.10	083130		
CTC: 20"	US26D	1,142.10	-		
	US32D	1,117.15	-		



Description	Finish	2021 List	Stock No.	Box Qty.	Case Qty.
988P					
Offset Pull	US3	303.95	-	1	12
Projection: 3"	US26	303.95	-		
CTC: 24"	US32D	303.95	-		
Fasteners: 3/8 - 16 FPHMS with finish washers					
<hr/>					
988B					
Offset Pull	US3	628.20	-	1	12
BTB Mounting	US26	628.20	-		
Projection: 3"	US32D	628.20	032030		
CTC: 24"					
<hr/>					
990P					
18° Pull Bar - Handed					
Pull Diameter: 1"					
O/A Height: 25"					
Projection: 2-3/4"					
Clearance: 1-3/4"					
CTC: 24"					
Specify handing					
Fasteners: 3/8 - 16 FPHMS with finish washers					
Left Hand	US3	700.50	-	1	12
	US4	700.50	-		
	US10B	700.50	-		
	US15A	700.50	-		
	US26	700.50	-		
	US26D	700.50	-		
	US32D	629.70	-		
Right Hand	US3	700.50	-	1	12
	US4	700.50	-		
	US10B	700.50	-		
	US15A	700.50	-		
	US26	700.50	-		
	US26D	700.50	-		
	US32D	629.70	-		

1. Items with the price in **bold and red** are Quick Ship items and ship in 24 hours.
Please use stock number when ordering. 2. U/M is each unless otherwise noted.



Trim & Auxiliary



Description	Finish	2021 List	Stock No.	Box Qty.	Case Qty.
990B					
18° Pull Bar - Handed					
BTB Mounting					
Pull Diameter: 1"					
O/A Height: 25"					
Projection: 2-3/4"					
Clearance: 1-3/4"					
CTC: 24"					
Specify handing					
Left Hand	US3	1,421.35	-	1	12
	US4	1,421.35	-		
	US10B	1,421.35	-		
	US15A	1,421.35	-		
	US26	1,421.35	-		
	US26D	1,421.35	-		
	US32D	1,279.85	124116		
Right Hand	US3	1,421.35	-	1	12
	US4	1,421.35	-		
	US10B	1,421.35	054966		
	US15A	1,421.35	-		
	US26	1,421.35	-		
	US26D	1,421.35	-		
	US32D	1,279.85	124120		



1442					
Roller Latch with Full Lip Strike					
Material: Forged brass					
Latch Face: 1" x 3-3/8"	US3	33.30	070478	1	12
Strike: 1-11/16" x 2-1/4" x 5/32" thick	US4	47.05	011444		
Max Roller Projection: 3/8"	US10	47.05	011442		
Fasteners: #8 x 1" FPHWS; 8 - 32 x 3/4" FPHMS; #10 x 1-1/2" FPHWS	US10B	35.50	070462		
	US15	39.50	060770		
Non-Ferrous Version available on US3, US10B, US15, and US26D with extended lead time - 13.85 adder (NF) comp	US15A	63.50	054026		
	US19	35.50	054513		
	US26	34.95	064292		
	US26D	28.25	011443		



1443					
Roller Latch w/ ASA Strike					
Material: Forged brass					
Latch Face: 1" x 3-3/8"	US3	36.55	061158	1	12
Strike: 1-1/4" x 4-7/8" w/ 5/8" Lip	US4	49.20	051299		
Strike Thickness: .093"	US10B	41.65	061159		
Max Roller Projection: 3/8"	US15	55.20	060765		
Fasteners: 12 - 24 x 1/2" FPHMS; #12 x 3/4" FPHWS; #10 x 1-1/2" FPHWS	US15A	63.50	054032		
	US19	41.65	054515		
	US26	47.05	088079		
	US26D	31.10	011446		



Description	Finish	2021 List	Stock No.	Box Qty.	Case Qty.
2610					
Finger Pull	US3		013049	-	500
Material: Brass	US4	See Sliding Door Hardware Section for Pricing	071953		
Overall Diameter: 31/32"	US5		-		
Finger Pull Diameter: 3/4"	US10A		068711		
Pull Clearance: 5/16"	US15		040589		
Projection: 1/32"	US15A		-		
	US26		013047		
	US26D		071169		



2620					
Round Flush Pull	US3	See Sliding Door Hardware Section for Pricing	013081	-	50
Material: Brass	US4		072997		
Overall Diameter: 2-1/16"	US5		072148		
Finger Pull Diameter: 1-11/16"	US10A		072534		
Pull Clearance: 11/32"	US15		072624		
Projection: 5/64"	US15A		072158		
	US26		072554		
	US26D		075322		



2630					
Round Flush Pull	US3	See Sliding Door Hardware Section for Pricing	051919	-	50
Material: Brass	US4		073783		
Overall Diameter: 2-7/16"	US5		053163		
Finger Pull Diameter: 2-1/16"	US10A		073053		
Pull Clearance: 11/32"	US15		073056		
Projection: 3/32"	US15A		005307		
	US26		023430		
	US26D		023431		



2640					
Oblong Flush Pull	US3	See Sliding Door Hardware Section for Pricing	096760	-	50
Material: Brass	US4		075056		
Size: 1-5/16" x 2-3/4"	US5		074270		
Cup Clearance: 5/16"	US10A		074533		
Fasteners: #6 x 5/8" OPHWS	US15		074711		
	US15A		074350		
	US26		026751		
	US26D		074664		

1. Items with the price in **bold and red** are Quick Ship items and ship in 24 hours. Please use stock number when ordering. 2. U/M is each unless otherwise noted.



Trim & Auxiliary



Description	Finish	2021 List	Stock No.	Box Qty.	Case Qty.
9558 Wood Knob Knob Diameter: 1-1/2" Base Diameter: 15/16" Fasteners: #8 x 1-3/4" PPHWS	Wood	See Sliding Door Hardware Section for Pricing	096567	-	100



9566 Knob Material: Zinc Knob Diameter: 1-1/4" Projection: 1" Fasteners: #8 - 32 x 2" PPHMS; #8 - 32 x 1-3/4" PPHMS	US3 US4 US5 US10A US10B US15 US15A US26 US26D	See Sliding Door Hardware Section for Pricing	099824 098635 - 098634 098633 098632 - 098628 098627	-	100
--	---	--	--	---	-----



9567 Rose - For use with 9566 knob Material: Zinc Base Diameter: 1-3/4" Projection: 15/32" Fasteners: #8 - 32 x 2" PPHMS; #8 - 32 x 1-3/4" PPHMS	US3 US4 US5 US10A US10B US15 US15A US26 US26D	See Sliding Door Hardware Section for Pricing	099825 - - - 098624 098623 - 098621 098620	-	100
---	---	--	--	---	-----



9865 Plastic Pull Overall Diameter: 1-31/32" Finger Pull Diameter: 1-19/32" Pull Clearance: 11/32" Projection: 5/64"	Plastic	1.05	098993	-	100
--	---------	------	--------	---	-----



9882 Pocket Door Edge Pull Material: Brass Finger Pull Extends: 3/4" Faceplate: 3/4" x 3-7/8" Fasteners: #6 x 5/8" FPHWS Note: See Sliding Door section for pricing and multiplier.	US3 US4 US10 US10B US26 US26D	15.05 18.20 15.05 18.20 18.20 18.20	049582 049583 049578 049580 049579 049581	-	100
--	--	--	--	---	-----



Description	Finish	2021 List	Stock No.	Box Qty.	Case Qty.
9884 Pocket Door Edge Pull Material: Zinc Finger Pull Extends: 1-1/16" Faceplate: 21/32" x 3-1/2" Fasteners: #6 x 5/8" FPHWS Note: See Sliding Door section for pricing and multiplier.	US3	See Sliding Door Hardware Section for Pricing	099056	-	20



Description	Finish	2021 List	Stock No.	Box Qty.	Case Qty.	Disc Code
208 Kick Down Door Holder Material: Aluminum alloy Base: 1-5/8" x 1-7/8" Arm: 3-7/8" Fasteners: #6 x 3/4" FPHWS	US15A/AN	7.00	039115	5	50	780
	US26	7.00	001104			
	US26D	7.00	075679			



209 Floor Door Stop Material: Zinc Height: 1-1/4" Base Diameter: 1-3/32" Tip Diameter: 19/32" Fasteners: #8 x 2" FPHWS U/M - 1 each	US26	1.20	76165	5	50	780
---	------	------	-------	---	----	-----







210 Door Stop - Rigid Material: Zinc Projection: 3" Base Diameter: 1" Tip Diameter: 11/16" Fasteners: #8 x 5/8" wood thread U/M - 1 each	US3	1.95	076443	5	50	780
	US4	1.70	078852			
	US5/ABA	1.80	078854			
	US10A	1.80	075736			
	US10R	1.80	097367			
	US15A/AN	1.80	039117			
	US15	1.80	039118			
	US26	1.75	076171			
	US26D	1.95	076170			

1. Items with the price in **bold and red** are Quick Ship items and ship in 24 hours.
Please use stock number when ordering. 2. U/M is each unless otherwise noted.



Trim & Auxiliary

	Description	Finish	2021 List	Stock No.	Box Qty.	Case Qty.	Disc Code
	211 Door Stop - Flexible	US3	1.55	076206	10	100	780
	Material: Zinc	US4	1.30	001109			
	Projection: 3-1/8"	US5/ABA	1.70	053162			
	Base Diameter: 1"	US10A	1.70	076199			
	Tip Diameter: 9/16"	US10R	1.70	097368			
	Fasteners: #8 x 3/4" PPHWS	US15A/AN	1.70	039126			
	U/M - 1 each	US15	1.70	039121			
		US26	1.40	076205			
		US26D	1.55	076203			
	212 Hinge Pin Door Bumper	US3	2.05	056477	10	100	780
	Material: Zinc	US4	1.95	023084			
	U/M - 1 each	US5/ABA	2.05	023083			
	Adjustable from 180° to 120°	US10A	1.70	076219			
	For use with residential hinges	US10R	1.70	097369			
	Works with 1/4" hinge pins	US15A/AN	2.05	034530			
		US15	2.00	034492			
		US26	1.55	076221			
		US26D	1.55	076220			
	1412 Door Guard	US3	8.80	056475	5	50	780
	Arm Length: 4"	ABA	6.80	076222			
	Material: Zinc	US15A/AN	6.80	035285			
	Fasteners: #6 x 3/4" FPHWS	US15	6.80	035279			
	U/M - 1 each with screws	US26	6.80	011431			
		US26D	8.80	076223			
	1413 Flush Bolt - Square Corners	US3	8.90	051915	10	100	780
	Material: Brass w/ steel components	US4	8.90	055562			
	Bolt Diameter: 1/2"	US5/ABA	10.90	051916			
	Bolt Throw: 15/16"	US10A	10.90	-			
	Faceplate: 3/4" x 6"	US10R	10.90	072931			
	Backset: 7/16"	US15A/AN	10.90	035457			
	Strike: 7/8" x 1-3/4"	US15	8.90	035457			
	Fasteners: #6 x 3/4" FPHWS	US26	8.90	-			
	U/M - 1 each with screws	US26D	8.90	055561			



Description	Finish	2021 List	Stock No.	Box Qty.	Case Qty.	Disc Code
1414						
Flush Bolt	US3	8.90	0519177	10	100	780
Material: Brass w/ steel components	US5/ABA	10.90	051918			
Bolt Diameter: 1/2"	US10A	10.90	055586			
Bolt Throw: 15/16"	US10R	10.90	097374			
Faceplate: 3/4" x 6"	US15A/AN	10.90	040832			
Backset: 7/16"	US15	8.90	040830			
Strike: 7/8" x 1-3/4"	US26	8.90	055570			
Fasteners: #6 x 3/4" FPHWS	US26D	8.90	055589			
Strikeplate and screws, U/M - 1 each						



1415						
Strike Plate	US3	2.05	081300	100	500	780
Material: Brass	US10A	2.05	081308			
Size: 7/8" x 1-3/4"	US15A/AN	2.05	081311			
Fasteners: #6 x 3/4" FPHWS	US15	2.05	081305			
U/M - 1 each with screws	US26D	2.05	081307			



1416						
Flush Bolt - Single Route	US3	10.55	078952	10	100	780
Material: Brass w/ steel components	US4	10.55	076239			
Bolt Diameter: 5/16"	US5/ABA	12.50	076225			
Backset: 3/8"	US10A	12.50	076236			
Faceplate: 3/4" x 7-1/8"	US10R	12.50	097375			
Strike: 21/32" x 1-1/2"	US15A/AN	12.50	035990			
Bolt Throw: 7/8"	US15	12.50	036004			
Fasteners: #8 x 1-1/2" FPHWS; #6 x 3/4" FPHWS	US26	10.55	076238			
U/M - 1 each with strikeplate and screws	US26D	10.55	076237			



1418						
Flush Bolt with Extension Rod	US3	12.40	068407	10	100	780
Material: Brass w/ steel components	US4	12.40	068337			
Bolt Diameter: 5/16"	US5/ABA	12.40	068263			
Backset: 3/8"	US10A	14.25	068467			
Faceplate: 23/32" x 7-3/8"	US10R	13.65	072930			
Strike: 5/8" x 1-1/2"	US15A/AN	14.25	068249			
Bolt Throw: 3/4"	US15	12.40	068448			
Extended Rod Length: 16"	US26	12.40	068447			
Fasteners: #8 x 1-1/2" FPHWS; #6 x 3/4" FPHWS	US26D	12.40	068436			
U/M - 1 each						







1419						
Flip/Foot Bolt Flush Bolt	US3	9.90	019228	10	100	485
Material: Brass with steel components	US4	9.90	019227			
Faceplate: 3/4" x 7-1/8"	US5/ABA	12.40	019224			
Strike: 5/8" x 1-1/2"	US10A	12.40	019627			
Bolt Diameter: 5/16"	US10R	12.40	019212			
Bolt Throw: 3/4"	US15A/AN	9.90	019216			
Backset: 5/16"	US15	9.90	019231			
Fasteners: #8 x 1-1/2" FPHWS; #6 x 3/4" FPHWS	US26	9.90	019230			
U/M - 1 each	US26D	9.90	019229			

1. Items with the price in **bold and red** are Quick Ship items and ship in 24 hours.
Please use stock number when ordering. 2. U/M is each unless otherwise noted.



Trim & Auxiliary

	Description	Finish	2021 List	Stock No.	Box Qty.	Case Qty.	Disc Code
	1439 Magnetic Catch Material: Plastic Catch: 1-1/16" x 2" Strike: 7/8" x 1" Fasteners: #6 x 1/2" TPHWS; #4 x 1/2" FPHWS U/M - 1 each with screws	-	2.05	011439	25	100	780
	1446 Ball Catch Material: Zinc Faceplate: 1" x 2-1/4" Strike: 1-3/8" x 2-1/4" Fasteners: #6 FPHWS U/M - 1 each with two strikeplates and screws	US3 US4 US5/ABA US10A US10R US15A/AN US15 US26 US26D	3.95 3.95 4.50 4.50 4.50 4.50 4.50 3.95 3.95	051902 055624 051903 055634 097376 036870 036878 055635 055608	10	50	780
	1447 Drive in Ball Catch Material: Zinc Faceplate: 1" diameter Strike: 1-3/8" x 2-1/4" Fasteners: #6 FPHWS U/M - 1 each with 2 strikeplates and screws	US3 US4 US5/ABA US10A US10R US15A/AN US15 US26 US26D	3.60 3.95 4.50 4.50 4.50 4.50 4.50 3.60 3.95	043896 055638 055636 055639 097377 037445 036882 055640 055637	10	50	780
	1448 Strike Plate for 1446 or 1447 Size: 1-3/8" x 2-1/4" Fasteners: #6 FPHWS U/M - 1 each with screws	US3 US4 US5/ABA US10A US10R US15A/AN US15 US26 US26D	2.05 2.05 2.05 2.05 2.05 2.05 2.05 2.05 2.05	079333 079334 079351 079339 097378 079340 079335 079337 079338	100	500	780
	1449 Drive In Ball Catch for 1448 Material: Zinc Faceplate: 1" diameter U/M - 1 each	US4	1.80	101876	100	300	780



Description	Finish	2021 List	Stock No.	Box Qty.	Case Qty.	Disc Code
1755						
115° One Way Door Viewer	US3	6.30	056866	10	100	490
UL Listed	US4	6.30	011919			490
U/M - 1 each	US5/ABA	6.20	076270			780
90 min. fire rated	US10A	6.20	076272			780
Door Thickness: 1-3/8" - 2-1/8"	US10R	6.20	097475			780
	US15A/AN	6.20	076271			780
	US15	6.20	076276			780
	US26	6.05	076274			780
	US26D	6.10	055225			490



1756						
185° One Way Door Viewer	US3	9.50	011920		50	490
UL Listed	US4	9.50	066884			490
U/M - 1 each	US5/ABA	14.15	072679			780
90 Minute Fire-Rated	US10A	14.15	076442			780
Door Thickness: 1-3/8" - 2-1/8"	US10R	14.15	097476			780
	US15A/AN	14.15	076441			780
	US15	14.15	067422			780
	US26	14.00	044337			780
	US26D	9.85	086149			490



1758						
115° One Way Door Viewer with Privacy Flap	US3	10.00	146215	10	100	490
Door Thickness: 1-3/8" - 2-1/8"	US10A	9.75	146216			780
UL Listed	US26	9.75	146217			780
U/M - 1 each	US26D	9.70	146218			490
90 Minute Fire-Rated						



1759						
185° One Way Door Viewer with Privacy Flap	US3	13.00	146219		50	490
Door Thickness: 1-3/8" - 2-1/8"	US10A	18.50	146220			780
UL Listed	US26	18.50	146221			780
U/M - 1 each	US26D	12.60	146222			490
90 Minute Fire-Rated						



1765						
Privacy Flap for 115° One Way Viewer 1755	US3	4.85	146207	1	200	490
	US10A	4.35	146208			780
	US26	4.35	146209			780
	US26D	4.85	146210			490









1766						
Privacy Flap for 185° One Way Viewer 1756	US3	5.55	146211	1	200	490
	US10A	5.15	146212			780
	US26	5.15	146213			780
	US26D	5.40	146214			490

1. Items with the price in **bold and red** are Quick Ship items and ship in 24 hours.
Please use stock number when ordering. 2. U/M is each unless otherwise noted.



Trim & Auxiliary

Description	Finish	2021 List	Stock No.	Box Qty.	Case Qty.	Disc Code
 <p>BL6211 Door Stop Flexible Projection: 3" Tip Diameter: 7/16" Base Diameter: 3/4" Fastener: #8 x 11/32" thread U/M - 1 each</p>	US3	0.95	056256	-	150	780
	US4	0.80	058289			
	US5/ABA	0.90	058295			
	US10A	0.90	056269			
	US10R	0.90	097482			
	US15	0.90	040032			
	US26D	0.90	040031			
 <p>BL6212 Hinge Pin Door Bumper U/M - 1 each Adjustable from 180° to 120° For use with residential hinges Works with 1/4" hinge pins</p>	US3	1.15	056320	-	100	780
	US4	1.10	058298			
	US5/ABA	1.10	058296			
	US10A	1.10	056321			
	US10R	1.10	097483			
	US15A/AN	1.10	056315			
	US15	1.10	040033			
	US26	1.15	056323			
US26D	1.10	040035				
 <p>6601 Handrail Bracket Material: Cast Aluminum Base to Center of Rail: 2-3/4" Projection: 3-1/4" Fasteners: #8 x 1-1/2" OPHWS; #8 x 3/4" OPHWS U/M - 1 each with screws</p>	US3	2.20	011385	-	300	780
	US4	2.20	011380			
	US5/ABA	2.85	011328			
	US10A	3.00	011374			
	US10R	3.00	011371			
	US15A/AN	2.85	011327			
	US15	2.85	011335			
	US26	2.20	011332			
US26D	2.85	011331				
 <p>BL6610 Coat & Hat Hook Max. Projection: 2-13/16" Min. Projection: 1-5/16" Fastener: #6 x 3/4" FPHWS U/M - 1 each with screws</p>	US3	1.10	056300	-	100	780
	US4	1.05	058317			
	US5/ABA	1.10	058329			
	US10A	1.10	056299			
	US15	1.10	040045			
	US26	1.10	056298			
	US26D	1.10	040046			
 <p>BL6793 Pole Sockets Material: Steel U/M - 2 each with screws</p>	2D	1.55	013512	-	100	780
 <p>BL6794 Pole Sockets Material: Plastic U/M - 2 each with screws</p>		0.95	013514	-	100	780



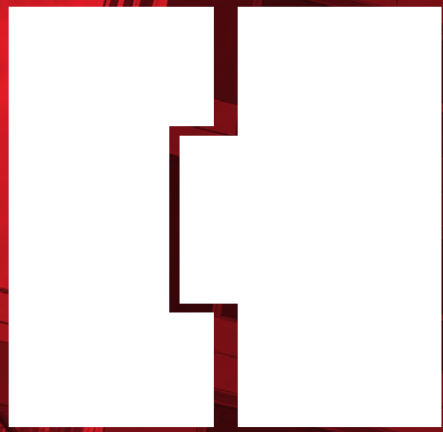

HAGER®

COMPANIES

TABLE OF CONTENTS

A		I	
Astragal	21, 23-27	Interlocking Thresholds	12
Acoustic Pad	15	Interlocking Weatherstripping	15
B		Intumescent Weatherstripping	15-17
Barrier Free Ramps	9	J	
Bumper Thresholds	9-10	Jamb Weatherstripping	
Bumper/Stop Strips	10	Jamb Weatherstripping	22-23, 25-27
C		Adjustable	25
Carpet Thresholds	10-11	Magnetic	25
Cast Abrasive Aluminum Thresholds		L	
Saddle Thresholds	13-14	Lead Times	5
Cover Plate	14-15	M	
D		Materials and Finishes	2
Door Bottoms		P	
Automatic Door Bottoms	19	Panic Thresholds	11-12
Door Shoes	21-22	Press-On Weatherstripping	15-18
Door Sweeps	20-21, 23, 26-27	Product Information	2
Rain Drip	21-23	R	
E		Rain Drips	
Edge Sealing Systems	15-18	DoorBottom Rain Drip	21-22
Elevator	10	Overhead Rain Drip	23
F		Replacement Inserts	4
Fabrication Options	5	Residential Thresholds	6-7
Fasteners	2	S	
Fastener Options	3	Smoke Seals	15-18
Finish Options	2,5	Saddle Thresholds	6-10, 13-14
Fire Labeling	2	Spring Bronze	23
Floor Closer Thresholds	13-14	Stock Numbers	29-43
Floor Plates and Supports	9-10	Sure-Step	5
G		T	
Garage Weatherstripping	22	Thermal Barrier Thresholds	
H		Saddle Thresholds	7-9
Half Saddle Thresholds	6, 8-9, 12	Panic Thresholds	11-12
How to Order	3	W	
		Water Return - Interlocking	12



Thresholds & Weatherstripping

PRODUCT INFORMATION

Drawings or illustrations used in the Price Book are subject to change without notice. Questions regarding any dimensions should be directed to Hager Companies Customer Service.

MATERIALS AND FINISHES

Metals

All aluminum extrusions are of alloy 6063-T5. All bronze extrusions are of alloy CDA385 brass specified as Architectural Bronze in the industry. For stock finishes, refer to the code listed below each individual item throughout the price book. Please inquire for the availability on non-stock finishes.

MIL-	Mill Finish Aluminum	LBA -	Light Bronze Anodized Aluminum
300-	Polished Bronze (CDA385)	MIB-	Mill Finish Bronze (CDA385)
CAL-	Cast Aluminum	GYP-	Primed Steel (Grey)
DBA-	Dark Bronze Anodized Aluminum	BLA-	Black Anodized Aluminum
SCA-	Hager Carb-Coat on Aluminum	32D-	Matte Stainless Steel (Non-Extruded)
SCB-	Hager Carb-Coat on Bronze	WH-	White Paint on Aluminum
GLD-	Gold Anodized Aluminum	CLR-	Clear Anodized Aluminum
10B-	Antique Bronze, Oiled	BCA-	Bright Clear Anodized Aluminum

Gaskets

Gasketing is available in a wide variety of materials. Vinyl is an economical choice and remains flexible down to -40°F. Neoprene gasketing is supplied both as a solid (dense) and as a closed cell sponge with a tough outer skin, remaining flexible down to -50°F. Silicone gasketing provides the best resistance to cold by remaining flexible down to -70°F. To order gasket only, see how to order example on page 3.

B-	Nylon Brush (Black)	V-	Vinyl
N-	Neoprene, Solid EPDM	W-	Pile (Thread May Be Removed To Allow Expansion) (Grey)
	Closed Cell Sponge EPDM, TPE (Black)		
S-	Silicone		

Colors for Press-On Gasketing

- B - Brown
- S - Charcoal or Black
- T - Tan
- W - White
- G - Grey

FASTENERS

All products are furnished with appropriate fasteners as listed, except where noted. Most thresholds are furnished with mounting holes and #10 x 1-1/2" flat head sheet metal screws. Most weatherstripping products are furnished with slotted holes and #6 x 5/8" pan head sheet metal screws. Brass screws are furnished with bronze products.

FIRE LABELING

All products containing non-metallic seals have been listed and labeled resulting from a determination by a certified fire laboratory that these products do not adversely affect the fire resistance of the door or frame. All products are regularly checked under a labeling and listing inspection service.



HOW TO ORDER

When placing your order, please specify item number, gasket code, size and finish code. Also be sure to state any special fabrication needs or optional fasteners desired. Thresholds are fabricated in standard sizes with 1/2" extra on thresholds 50" and under. Thresholds over 50" are supplied with 1" extra length for fitting.

Example: 891S V 36 x 84 MIL

Item #	Gasketing	Size	Finish
516S	S-Silicone	36"	GLD
575S	W-Pile	48"	MIB
750S	N-Neoprene	36" x 84"	32D
802S	B-Nylon Brush	48" x 96"	MIL
885S	V-Vinyl	36" x 84"	DBA
881S*	N-Neoprene	48" x 84"	000

*Use Finish 000 to receive gasket only

Thresholds must be purchased and billed at 4" increments, except for Abrasive Cast Aluminum Thresholds and Automatic Door Bottoms. Weatherstripping must be purchased and billed at 4" increments. Threshold and weatherstripping products supplied in lengths up to 12'.

FASTENER OPTIONS

Thresholds

Add to List Price

#10 Wood Screws and Plastic Anchors.....	\$ 0.65 /ft
#10 Wood Screws and Lead Anchors	0.85 /ft
#10 Machine Screws and Lead Anchors.....	0.95 /ft
#10 S.S. Machine Screws and Lead Anchors	1.60 /ft
#10 S.S. Wood Screws	1.05 /ft
#10 S.S. Wood Screws and Plastic Anchors	1.50 /ft
#10 S.S. Wood Screws and Lead Anchors.....	1.70 /ft
#10 Torx Wood Screws	2.00 /ft
#10 S.S. Torx Wood Screws	3.05 /ft
#10 Torx Machine Screws.....	1.90 /ft
#10 S.S. Torx Machine Screws.....	2.95 /ft
#10 S.S Torx Machine Screws and Lead Anchors	2.50 /ft
1/4-20 Machine Screws and Lead Anchors.....	1.40 /ft
1/4-20 S.S. Machine Screws and Lead Anchors.....	2.00 /ft
1/4-20 Flat Head Sleeve Anchor	2.55 /ft
1/4 Tap-Con Type (Self-Tapping Concrete).....	1.40 /ft
Cast-On Anchors (Cast Products Only)	8.40/ea
Thru-bolts 1/4 - 20 x 1-1/4" FPHM with 1-1/4" post	3.05 /ft

Note: Standard fasteners included: #10 x 1-1/2" Phillips flat-head sheet metal screws.

Weatherstripping

Add to List Price

#6 x 5/8" Phillips Pan-head Stainless Steel Screws.....	\$ 0.55 /ft
#6 x 5/8" Phillips Self-drilling (TEK) Screws	0.35 /ft
#6 x 5/8" S.S. Phillips Self-drilling (TEK) Screws.....	0.45 /ft
#6 x 5/8" Phillips Pan-head Torx Sheet Metal Screws.....	1.60 /ft
Two-way Self-adhesive Tape	1.50 /ft

Note: Standard fasteners included: #6 x 5/8" Phillips pan-head sheet metal screws.



Thresholds & Weatherstripping

REPLACEMENT INSERTS

Vinyl - Grey

List Price (Per Foot)

400S.....	\$ 1.40
434S, 435S, 477S, 478S, 481S, 516S, 517S, 518S, 520S, 532S, 541S, 552S, 560S, 565S, 570S, 575S, 580S, 599S, 771S, 837S, 860S.....	0.85
751S, 772S.....	2.55
756S, 770S, 884S.....	1.20
774S, 777S, 778S, 779S, 780S, 782S, 783S.....	1.40
881S, 885S, 890S, 891S, 896S.....	0.85

Vinyl - Black

Black inserts are supplied standard with DBA aluminum extrusions. Must specify on order for black replacement gaskets.

434S, 435S, 477S, 478S, 481S, 516S, 517S, 518S, 520S, 532S, 541S, 552S, 560S, 565S, 570S, 575S, 580S, 599S, 771S, 837S, 860S.....	0.85
881S, 885S, 890S, 891S, 896S.....	0.75

Silicone - Grey

434S, 435S, 477S, 478S, 481S, 516S, 517S, 518S, 520S, 532S, 541S, 552S, 560S, 565S, 570S, 575S, 580S, 599S, 771S, 837S, 860S.....	2.50
730S, 740S.....	4.95
750S.....	1.40
751S, 772S.....	2.75
875S.....	1.60
881S, 885S, 890S, 891S, 896S.....	1.70

Silicone - Black

Black inserts are supplied standard with DBA aluminum extrusions. Must specify on order for black replacement gaskets.

434S, 435S, 477S, 478S, 481S, 516S, 517S, 518S, 520S, 532S, 541S, 552S, 560S, 565S, 570S, 575S, 580S, 599S, 771S, 837S, 860S.....	2.45
881S, 885S, 890S, 891S, 896S.....	1.70

Neoprene - Black

434S, 435S, 477S, 478S, 481S, 516S, 517S, 518S, 520S, 532S, 541S, 552S, 560S, 565S, 570S, 575S, 580S, 599S, 771S, 837S, 860S.....	2.25
730S, 740S, 864S, 870S, 872S*, 873S, 877S, 878S, 880S, 892S.....	1.40
743S, 747S, 861S.....	2.65
754S, 774S, 777S, 778S, 779S, 780S, 782S.....	1.40
750S, 753S, 785S, 862S, 863S.....	1.50
858S, 865S, 866S.....	3.80
871S, 874S, 875S.....	1.50
881S, 885S, 890S, 891S, 896S.....	1.05

Neoprene - Grey

872S.....	5.15
-----------	------

Pile - Grey

434S, 435S, 477S, 478S, 516S, 517S, 518S, 520S, 532S, 541S, 552S, 560S, 565S, 570S, 575S, 580S, 599S, 728S, 771S, 789S, 837S, 845S, 847S.....	0.95
--	------

Nylon Brush - Black

770S, 800S, 802S, 882S, 883S.....	2.95
801S, 803S, 806S, 808S.....	5.90



FABRICATION OPTIONS

	Add to List Price
Bevel One Edge of Threshold.....	\$ 5.80 /ft
Rip One Edge (Width) of Threshold.....	5.80 /ft
L-Notch Both Ends of Threshold	11.05 /ea
L-Notch setup charge on less than 100 pieces.....	48.00
U-Notch Both Ends of Threshold.....	21.95 /ea
U-Notch setup charge on less than 100 pieces.....	79.00
Cast Abrasive Notching.....	POA
Tack Weld One Line of Threshold.....	POA
Pan for Water Return Threshold.....	1.05 /ft
End Caps for Automatic Door Bottoms (Mortised Models).....	DBA 7.60 /2 Caps
.....	GLD 7.60 /2 Caps
Lead Lining (Automatic Door Bottoms) - Up to 48".....	127.80

FINISH OPTIONS

	Add to List Price
Clear Anodized (CLR).....	Price on Application
Black Anodized (BLA).....	Price on Application
White Paint (WHP).....	Price on Application

SURE-STEP

	Add to List Price
Up to 4" Width	22.20 /ft
Up to 5" Width	27.75 /ft
Up to 6" Width	33.20 /ft
Up to 7" Width	38.85 /ft
Up to 8" Width	44.35 /ft

QUICK SHIP

Products denoted with **bold and red** in the stock number listing in the back of the pricing section are available to order through the QuickShip program and ship within 24 hours. When ordering these products please visit www.hagerco.com and log in to MyHager to access the 'Quick Ship' portal. Due to the promptness of the fulfillment process, Quick Ship orders are non-cancellable.

LEAD TIMES

Stock items will typically ship in five working days or less from the order entry date. Made-to-order items will typically ship in 15 working days depending on seasonal volume and order complexity. Special orders including industrials, special machining, and large quantities may need to be scheduled. The anticipated ship date will be included with each order acknowledgement. Please contact Customer Service if product availability is in question.

CANCELLATION NOTIFICATION

Cancellation for made-to-order items must be communicated within 48 hours of order placement.



Thresholds and Weatherstripping

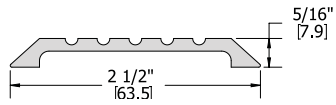

401S
Threshold - Saddle
2-1/2" x 5/16"

Description	Finish	Without Insert		With Insert		Comparison Numbers
		N	S	V	W	
401S Threshold - Saddle 2-1/2" x 5/16"	MIL		7.25			NGP: 211 Pemko: 166 ANSI: J32130
	DBA		10.00			
	GLD		11.55			

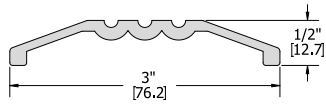

402S
Threshold - Saddle
3" x 1/2"

402S Threshold - Saddle 3" x 1/2"	MIL		7.50			Pemko: 169 ANSI: J32100
	DBA		10.20			
	GLD		11.90			

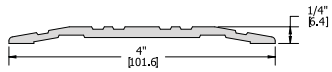

403S
Threshold - Saddle
4" x 1/4"

403S Threshold - Saddle 4" x 1/4"	MIL		7.35			NGP: 413 Pemko: 270 ANSI: J32130
	DBA		12.40			
	GLD		14.00			

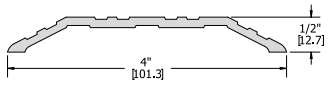

404S
Threshold - Saddle
4" x 1/2"

404S Threshold - Saddle 4" x 1/2"	MIL		8.40			NGP: 424E NGP: 412SS Pemko: 170 ANSI: J32130
	DBA		12.30			
	GLD		13.55			

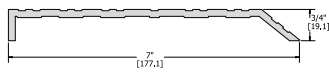

406S
Threshold - Half Saddle
7" x 3/4"

406S Threshold - Half Saddle 7" x 3/4"	MIL		24.30			NGP: 458 Pemko: 1877 ANSI: J33100
	DBA		26.15			
	GLD		28.60			

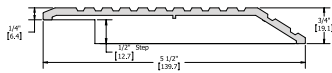

407S
Threshold - Half Saddle
1/2" Step
5-1/2" x 3/4"

407S Threshold - Half Saddle 1/2" Step 5-1/2" x 3/4"	MIL		14.10			NGP: 655 Pemko: 157 ANSI: J33180
	DBA		21.75			
	GLD		24.15			

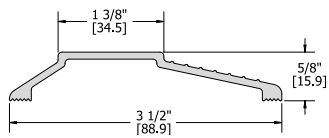

408S
Threshold - Saddle
3-1/2" x 5/8"

408S Threshold - Saddle 3-1/2" x 5/8"	MIL		6.65			Pemko: 212 ANSI: J30100
	DBA		9.35			
	GLD		10.65			

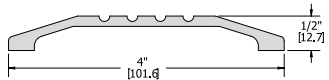

410S
Threshold - Saddle
4" x 1/2"

410S Threshold - Saddle 4" x 1/2"	MIL		8.55			NGP: 424 Pemko: 170 ANSI: J32130
	DBA		12.30			
	GLD		13.55			



Thresholds and Weatherstripping

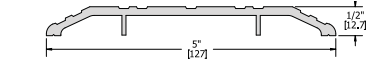

Description	Finish	Without Insert		With Insert			Comparison Numbers
		N	S	V	W		
412S Threshold - Saddle 5" x 1/2"	MIL		11.15				NGP: 425E NGP: 512SS Pemko: 171 ANSI: J32130
	DBA		16.30				
	GLD		17.75				

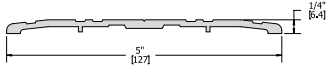

413S Threshold - Saddle 5" x 1/4"	MIL		10.65				NGP: 513 Pemko: 271 ANSI: J32130
	DBA		16.10				
	GLD		17.35				
	32D		139.25				

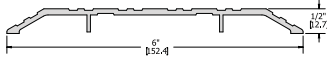

415S Threshold - Saddle 6" x 1/2"	MIL		13.90				NGP: 426 Pemko: 172 ANSI: J32130
	DBA		19.25				
	GLD		21.65				

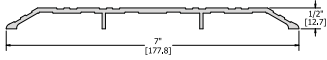

416S Threshold - Saddle 7" x 1/2"	MIL		18.30				NGP: 427 Pemko: 176 ANSI: J32130
	DBA		23.85				
	GLD		26.25				

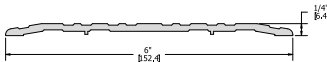

417S Threshold - Saddle 6" x 1/4"	MIL		13.35				NGP: 613 Pemko: 272 ANSI: J32130
	DBA		18.30				
	GLD		21.45				

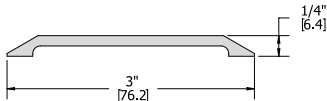

418S Threshold - Saddle 3" x 1/4"	MIL		7.70				NGP: 411 Pemko: 151 ANSI: J32330
	DBA		10.30				
	GLD		12.20				

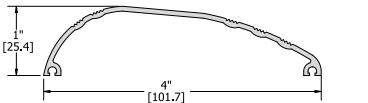

419S Threshold - Saddle 4" x 1"	MIL		7.35				Pemko: 219 ANSI: J30100
	DBA		9.15				
	GLD		10.20				

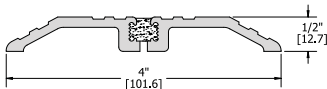

420S Threshold - Saddle Thermal Barrier 4" x 1/2"	MIL		15.75				NGP: 8424 Pemko: 252X2FG ANSI: J32193
	DBA		20.40				
	GLD		22.60				

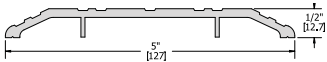

421S Threshold - Saddle Thermal Barrier 5" x 1/2"	MIL		17.65				NGP: 8425 Pemko: 252X3FG ANSI: J32193
	DBA		22.90				
	GLD		25.75				

Price Code: POA - Price on Application
 Insert Codes: V - Vinyl; N - Neoprene, EDPM, or TPE; S - Silicone; W - Pile; B - Nylon Brush; F - Vinyl Fin
 Finish Codes: MIL - Mill Finished Aluminum; DBA - Dark Bronze Anodized; GLD - Gold Anodized; MIB - Mill Finished Bronze; 32D - Matte Stainless Steel; GYP - Primed for Painting; CLR - Clear Anodized; CAL - Cast Aluminum



Thresholds and Weatherstripping

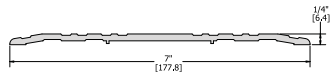
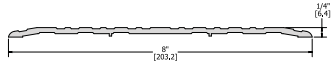
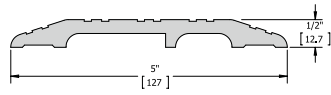
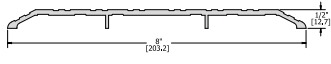
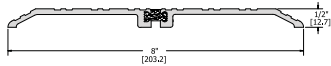
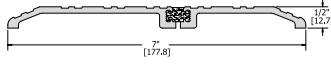
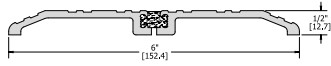

Description	Finish	Without Insert		With Insert			Comparison Numbers
		N	S	V	W		
422S Threshold - Saddle Thermal Barrier 6" x 1/2"	MIL	19.85					NGP: 8426 Pemko: 253X3FG ANSI: J32193
423S Threshold - Saddle Thermal Barrier 7" x 1/2"	MIL	21.65					NGP: 8427 Pemko: 253X4FG ANSI: J32193
424S Threshold - Saddle Thermal Barrier 8" x 1/2"	MIL	22.70					NGP: 8428 Pemko: 254X4FG ANSI: J32193
426S Threshold - Saddle 8" x 1/2"	MIL	22.60					NGP: 428E Pemko: 2548 ANSI: J32130
427S Threshold - Saddle Heavy Duty 5" x 1/2"	MIL	29.95					NGP: 425HD Pemko: 1715 ANSI: J32130
428S Threshold - Saddle 8" x 1/4"	MIL	21.25					NGP: 813 Pemko: 2748 ANSI: J32130
430S Threshold - Saddle 7" x 1/4"	MIL	18.20					NGP: 713 Pemko: 276 ANSI: J32130



Thresholds and Weatherstripping

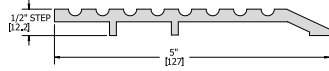

Description	Finish	Without Insert				With Insert			Comparison Numbers
		Insert	N	S	V	W			
431S Threshold - Half Saddle 5" x 1/2"	MIL		21.35					NGP: 325 Pemko: 229 ANSI: J33130	
	DBA		29.20						
	GLD		32.90						

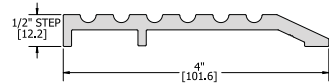

432S Threshold - Half Saddle 4" x 1/2"	MIL		18.80					NGP: 324 Pemko: 227 ANSI: J33130
	DBA		26.50					
	GLD		29.20					

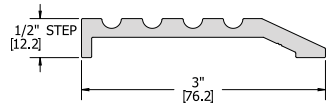

433S Threshold - Half Saddle 3" x 1/2"	MIL		8.40					NGP: 322 Pemko: 168 ANSI: J33130
	DBA		10.95					
	GLD		13.35					

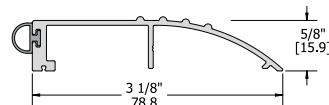

434S Threshold - Bumper Vinyl insert supplied unless other material specified 3-1/8" x 5/8"	MIL		8.40	8.40	6.45	6.45		Pemko: 205 ANSI: J30100
	DBA		10.75	10.75	8.00	8.00		
	GLD		12.20	12.20	9.25	9.25		

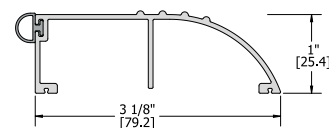

435S Threshold - Bumper Vinyl insert supplied unless other material specified 3-1/8" x 1"	MIL		10.10	10.10	7.60	7.60		Pemko: 2051 ANSI: J30100
	DBA		12.85	12.85	9.60	9.60		
	GLD		14.70	14.70	11.15	11.15		

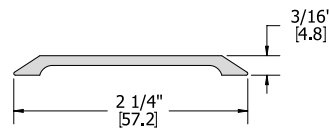

436S Threshold - Saddle 2-1/4" x 3/16"	MIL		5.50					NGP: 410 Pemko: 173 ANSI: J32330
	DBA		8.10					

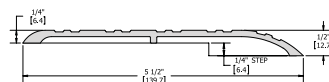

438S Threshold - Half Saddle 1/4" Step 5-1/2" x 1/2"	MIL		13.80					NGP: 653 Pemko: 158 ANSI: J32330
	DBA		20.40					

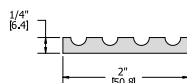

440S Threshold - Floor Plate 2" x 1/4"	MIL		8.40					NGP: 8142 Pemko: 190 ANSI: J37100
	DBA		10.75					
	GLD		12.30					

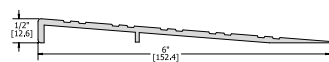

442S Threshold Barrier Free Ramp 1/2" Rise 6" x 1/2"	MIL		13.05					NGP: 657 Pemko: 259 ANSI: J38130
	DBA		17.45					
	GLD		20.20					

Price Code: POA - Price on Application
 Insert Codes: V - Vinyl; N - Neoprene, EDPM, or TPE; S - Silicone; W - Pile; B - Nylon Brush; F - Vinyl Fin
 Finish Codes: MIL - Mill Finished Aluminum; DBA - Dark Bronze Anodized; GLD - Gold Anodized; MIB - Mill Finished Bronze; 32D - Matte Stainless Steel; GYP - Primed for Painting; CLR - Clear Anodized; CAL - Cast Aluminum



Thresholds and Weatherstripping

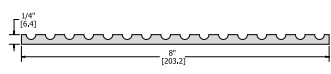
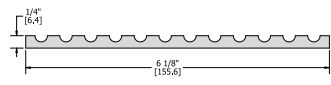
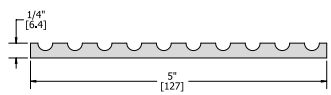
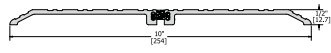
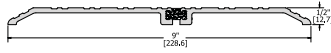
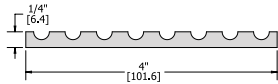
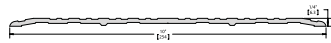
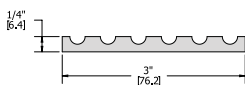
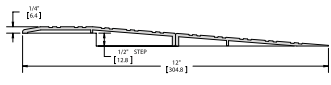
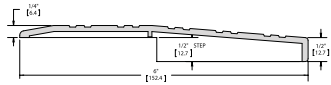

Description	Finish	Without Insert		With Insert			Comparison Numbers
		Insert	N	S	V	W	
443S Threshold Barrier Free Ramp 1/4" Rise 6" x 3/4"	MIL	14.85					Pemko: 257 ANSI: J30180
	DBA	19.65					
	GLD	22.40					
444S Threshold Barrier Free Ramp 3/4" Rise 12" x 3/4"	MIL	31.00					NGP: R050 Pemko: 257X259 ANSI: J38183
	DBA	38.05					
	GLD	44.55					
445S Threshold - Floor Plate 3" x 1/4"	MIL	11.35					NGP: 8143 Pemko: 191 ANSI: J37100
	DBA	15.45					
	GLD	17.85					
448S Threshold - Saddle 10" x 1/4"	MIL	28.25					NGP: 1013 ANSI: J37100 Pemko: 2750
	DBA	36.55					
	GLD						
450S Threshold - Floor Plate 4" x 1/4"	MIL	15.35					NGP: 8144 Pemko: 192 ANSI: J37100
	DBA	20.20					
	GLD	21.25					
451S Threshold - Saddle Thermal Barrier 9" x 1/2"	MIL	27.85					NGP: 8429 Pemko: 254X5FG ANSI: J32193
	DBA	35.60					
	GLD	38.65					
452S Threshold - Saddle Thermal Barrier 10" x 1/2"	MIL	30.80					NGP: 8430 Pemko: 255X5FG ANSI: J32193
	DBA	39.00					
	GLD	43.50					
455S Threshold - Floor Plate 5" x 1/4"	MIL	18.70					NGP: 8145 ANSI: J37100
	DBA	25.00					
	GLD	28.90					
460S Threshold - Floor Plate 6-1/8" x 1/4"	MIL	21.85					NGP: 8146 Pemko: 193 ANSI: J37100
	DBA	29.10					
	GLD	32.80					
465S Threshold - Floor Plate 8" x 1/4"	MIL	28.50					NGP: 8148 Pemko: 228 ANSI: J37100
	DBA	39.60					
	GLD	43.70					

Thresholds and Weatherstripping

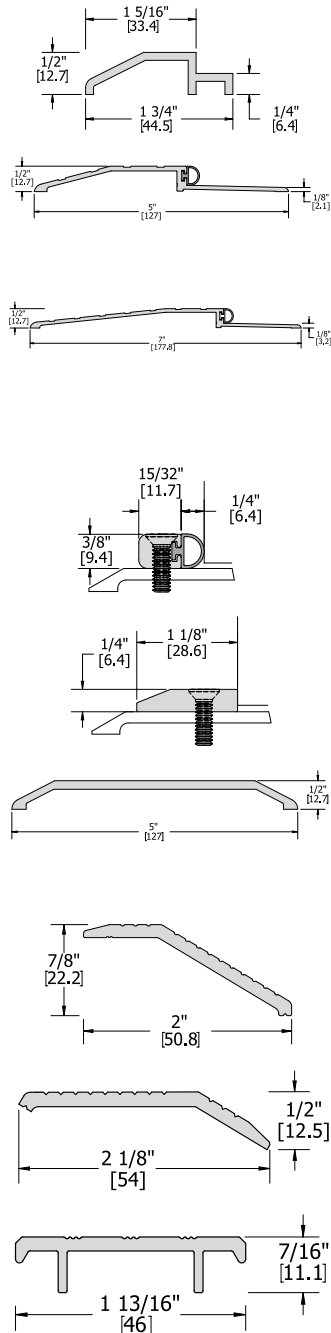

Description	Finish	Without Insert		With Insert			Comparison Numbers
		Insert	N	S	V	W	
470S Threshold Plate Support 1-3/4" x 1/2"	MIL		5.40				NGP: 8140
	DBA		7.70				Pemko: 195
	GLD		8.55				
477S Threshold - Bumper 5" x 1/2"	MIL		12.95	13.55	12.20	12.20	NGP: 950
	DBA		16.95	18.10	16.20	16.20	Pemko: 2001
	GLD		18.50	19.15	17.75	17.75	ANSI: J36100
478S Threshold - Bumper 7" x 1/2"	MIL		19.15	19.95	18.20	18.20	ANSI: J30100
	DBA		25.10	25.85	24.05	24.05	
	GLD		26.40	27.55	25.45	25.45	
481S Threshold Bumper Strip 23/32" x 3/8"	MIL		6.30	6.65	5.70	5.70	NGP: 2
	DBA		8.20	8.65	7.35	7.35	Pemko: 184
	GLD		9.45	9.15	8.95	8.95	
484S Threshold Bumper Strip 1-1/8" x 1/4"	MIL	5.50					NGP: 8136
	DBA	8.20					Pemko: 196
	GLD	8.65					
492S Threshold - Saddle 5" x 1/2"	MIL	13.45					Pemko: 154
	DBA	16.80					ANSI: J32330
	GLD	19.45					Pemko: 2132
503S Threshold - Carpet Edge 2" x 7/8"	MIL	6.45					NGP: 416
	DBA	10.20					ANSI: J32180
	GLD	11.55					Pemko: 2134
504S Threshold - Carpet Edge 2-1/8" x 1/2"	MIL	8.75					NGP: 417
	DBA	11.75					Pemko: 174
	GLD	12.95					ANSI: J32183
505S Threshold - Carpet Divider 1-13/16" x 7/16"	MIL	5.90					NGP: 414
	DBA	7.90					Pemko: 236
	GLD	8.95					ANSI: J32113

Price Code: POA - Price on Application
 Insert Codes: V - Vinyl; N - Neoprene, EDPM, or TPE; S - Silicone; W - Pile; B - Nylon Brush; F - Vinyl Fin
 Finish Codes: MIL - Mill Finished Aluminum; DBA - Dark Bronze Anodized; GLD - Gold Anodized; MIB - Mill Finished Bronze; 32D - Matte Stainless Steel; GYP - Primed for Painting; CLR - Clear Anodized; CAL - Cast Aluminum



Thresholds and Weatherstripping

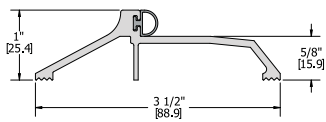
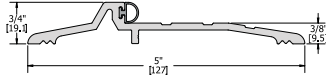
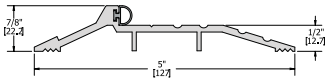
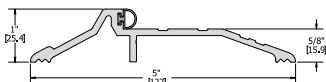
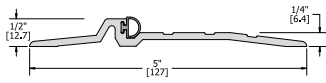
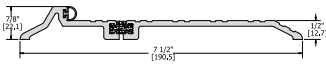
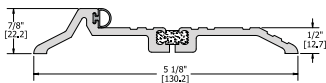
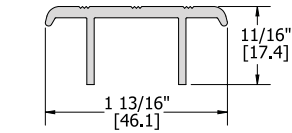
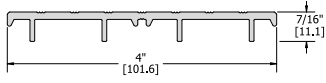

Description	Finish	Without Insert		With Insert			Comparison Numbers
		Insert	N	S	V	W	
506S Threshold - Carpet Divider 4" x 7/16"	MIL	10.30					NGP: 404
	DBA	14.00					Pemko: 2364
	GLD	16.10					ANSI: J32113
508S Threshold - Carpet Divider 1-13/16" x 1 1/16"	MIL	6.20					NGP: 414
	DBA	8.10					Pemko: 236
	GLD	8.75					ANSI: J32140
516S Threshold - Panic Thermal Barrier 5-1/8" x 7/8"	MIL		19.75	19.75	18.80	18.80	NGP: 8435
	DBA		26.25	26.25	24.50	24.50	Pemko: 253X226FG
	GLD		27.65	27.65	26.40	26.40	ANSI: J36190
518S Threshold - Panic Thermal Barrier 7-1/2" x 7/8"	MIL		25.00	25.00	23.65	23.65	NGP: 8437
	DBA		33.30	33.30	31.40	31.40	Pemko: 255X226FG
	GLD		36.65	36.65	35.85	35.85	ANSI: J36190
520S Threshold - Panic 5" x 1/2"	MIL		12.50	12.50	11.55	11.55	NGP: 896
	DBA		16.20	16.20	14.95	14.95	Pemko: 2005
	GLD		18.00	18.00	16.60	16.60	ANSI: J36130
532S Threshold - Panic 5" x 1"	MIL		15.35	15.35	14.20	14.20	NGP: 803
	DBA		20.40	20.40	18.90	18.90	Pemko: 181
	GLD		22.30	22.30	20.60	20.60	ANSI: J36100
541S Threshold - Panic 5" x 7/8"	MIL		15.05	15.05	14.00	14.00	NGP: 804
	DBA		20.30	20.30	19.85	19.85	Pemko: 177
	GLD		22.50	22.50	22.50	22.50	ANSI: J36100
552S Threshold - Panic 5" x 3/4"	MIL		14.85	14.85	14.10	14.10	NGP: 890
	DBA		19.65	19.65	18.90	18.90	Pemko: 179
	GLD		22.50	22.50	21.35	21.35	ANSI: J36100
560S Threshold - Panic 3-1/2" x 1"	MIL		12.95	12.95	12.10	12.10	NGP: 891
	DBA		18.10	18.10	16.95	16.95	Pemko: 185
	GLD		20.10	20.10	18.80	18.80	ANSI: J36300

Thresholds and Weatherstripping

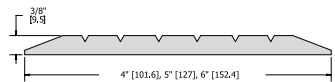
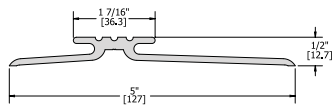
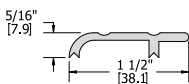
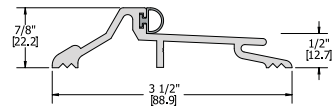
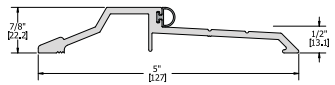
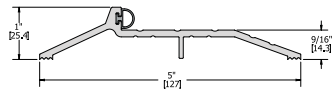
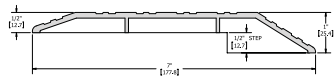

Description	Finish	Without Insert		With Insert			Comparison Numbers
		Insert	N	S	V	W	
572S Threshold - Half Saddle 1/2" Offset 7" x 1"	MIL		18.60				Pemko: 182 ANSI: J33180 NGP: 656
	DBA		25.20				
	GLD		29.85				
575S Threshold - Panic 5" x 1"	MIL		15.15	15.15	14.30	14.30	Pemko: 181 ANSI: J36100
	DBA		20.50	20.50	19.25	19.25	
	GLD		22.30	22.30	20.90	20.90	
580S Threshold - Panic 5" x 7/8"	MIL		17.65	17.65	16.95	16.95	NGP: 897 Pemko: 277 ANSI: J36100
	DBA		23.00	23.00	21.95	21.95	
	GLD		24.80	24.80	23.65	23.65	
599S Threshold - Panic 3-1/2" x 7/8"	MIL		14.60	14.60	14.00	14.00	Pemko: 159 ANSI: J36300
	DBA		19.45	19.45	20.70	20.70	
	GLD		21.25	21.25	20.20	20.20	
600S Threshold - Interlock Cap 1-1/2" x 5/16"	MIL		5.90				Pemko: 101 ANSI: J34170
	DBA		6.55				
	GLD		8.55				
604S Threshold - Interlock 5" x 1/2" *701S Interlocking Hook provided	MIL		14.50				Pemko: 114 ANSI: J34170
	DBA		18.10				
626S Threshold - Saddle Cast Abrasive Aluminum 8' Max Length							
	4" x 3/8"	CAL	101.25				
	5" x 3/8"	CAL	121.50				
	6" x 3/8"	CAL	141.65				

Price Code: POA - Price on Application
 Insert Codes: V - Vinyl; N - Neoprene, EDPM, or TPE; S - Silicone; W - Pile; B - Nylon Brush; F - Vinyl Fin
 Finish Codes: MIL - Mill Finished Aluminum; DBA - Dark Bronze Anodized; GLD - Gold Anodized; MIB - Mill Finished Bronze; 32D - Matte Stainless Steel; GYP - Primed for Painting; CLR - Clear Anodized; CAL - Cast Aluminum



Thresholds and Weatherstripping

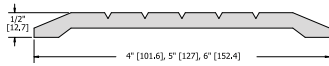

Description	Finish	Without Insert	N	With Insert S	V	W	Comparison Numbers
627S Threshold - Saddle Cast Abrasive Aluminum 8' Max Length							ANSI: J32230 NGP: 4425
4" x 1/2"	CAL	101.25					
5" x 1/2"	CAL	121.70					
6" x 1/2"	CAL	141.65					

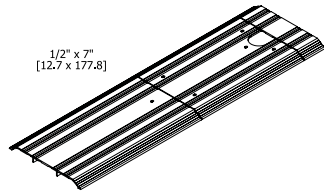

651S Threshold - Saddle for floor closers center hung without mitered end 7" x 1/2"							NGP: Type 1 Pemko: Type 11 ANSI: J39130
Up to 36"	MIL	144.80					
	DBA	161.60					
Up to 72"	MIL	288.65					
	DBA	323.00					
Lengths over 72" add the following per inch	MIL	1.80					
	DBA	2.10					

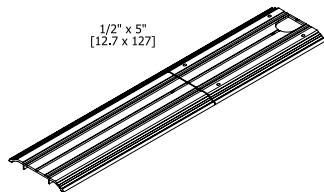

652S Threshold - Saddle for floor closers center hung without mitered end 5" x 1/2"							NGP: Type 1 Pemko: Type 11 ANSI: J39130
Up to 36"	MIL	116.05					
	DBA	129.50					
Up to 72"	MIL	236.25					
	DBA	263.70					
Lengths over 72" add the following per inch	MIL	1.80					
	DBA	2.10					

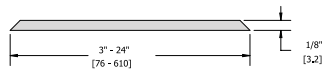

676S Cover Plate 8' Max. Length 1/8" Height							NGP: 818 Pemko: 18/1A ANSI: J17300
Charges: length X per foot charge X width in inches (3" min.) Example: 6 (ft. length) x 7.46 (ft. list) x 6 (in. width)	MIL	7.50					

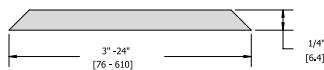

677S Cover Plate 8' Max. Length 1/4" Height							NGP: 814 Pemko: 14/1A ANSI: J17300
Charges: length X per foot charge X width in inches (3" min.) Example: 6 (ft. length) x 11.97 (ft. list) x 6 (in. width)	MIL	12.00					

Thresholds and Weatherstripping

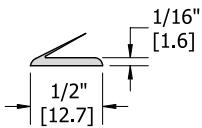
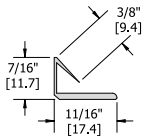
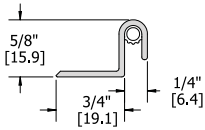
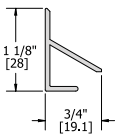
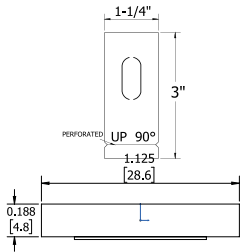
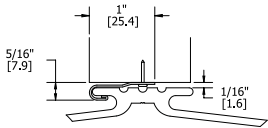

Description	Finish	Without Insert		With Insert			Comparison Numbers
		Insert	N	S	V	W	
701S Weatherstrip Interlock "J" Hook	MIL	3.70					NGP: 80 Pemko: 61 ANSI: ROY016
709S Acoustic Foam Pad Pack of 10	Black		27.30				NGP: 60FP
710S Press-On Mullion Smoke Seal Sponge Neoprene Note: Available in 120" only	Black	24.00/roll					NGP: 5100 Pemko: 5110 ANSI: ROC004
717S Weatherstrip Interlock Overhead Rain Drip	MIL DBA	4.15 6.60					NGP: 124 Pemko: 347 ANSI: R3Y106
718S Weatherstrip Interlock Overhead w/ Vinyl	MIL DBA				4.10 6.20		NGP: 123 Pemko: 68 ANSI: R3D036
719 Press-on Weatherstrip Edge Sealing System & Smoke Seal Intumescent material							NGP: 9450 ANSI: ROW154
7'	Brown	33.30					
8'	Charcoal	38.05					
9'		42.95					
3' x 7'		80.90					
4' x 7'		85.60					
4' x 8'		95.20					
6' x 7'		95.20					
7' x 7'		99.95					
720 Press-on Weatherstrip Edge Sealing System & Smoke Seal Intumescent material							NGP: 9850 Pemko: HSS2000XS44 ANSI: ROW154
3' x 7'	Brown	67.20					
4' x 7'	Charcoal	71.10					
4' x 8'	White	77.90					
6' x 7'		77.90					
7' x 7'		81.20					
6' x 8'		84.90					
8' x 8'		91.70					

Price Code: POA - Price on Application
 Insert Codes: V - Vinyl; N - Neoprene, EDPM, or TPE; S - Silicone; W - Pile; B - Nylon Brush; F - Vinyl Fin
 Finish Codes: MIL - Mill Finished Aluminum; DBA - Dark Bronze Anodized; GLD - Gold Anodized; MIB - Mill Finished Bronze; 32D - Matte Stainless Steel; GYP - Primed for Painting; CLR - Clear Anodized; CAL - Cast Aluminum



Thresholds and Weatherstripping

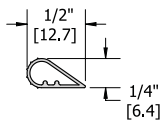
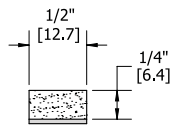
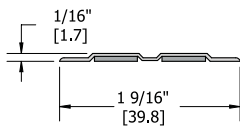
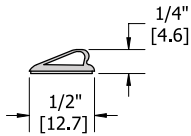
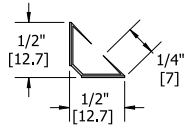

Description	Finish	Without Insert		With Insert		Comparison Numbers
		Insert	N	S	V	
721 Press-on Weatherstrip Smoke Seal TPE						NGP: 5020 ANSI: ROW154
7'	Brown					14.65
8'	Gray					16.80
9'	Charcoal					18.85
3' x 7'	White					35.65
4' x 7'						37.70
4' x 8'						41.95
6' x 7'						41.95
7' x 7'						44.00
722 Press- On Weatherstrip Edge Sealing System & Smoke Seal Intumescent material						
3' x 7'	Charcoal					67.80
4' x 7'	Brown					71.80
4' x 8'						79.85
6' x 7'						79.85
6' x 8'						87.80
7' x 7'						83.75
8' x 8'						95.80
724 Press-on Weatherstrip Edge Sealing System Intumescent material						NGP: 9500 ANSI: ROW156
7'	Charcoal					40.10
8'	Brown					45.75
9'						51.50
3' x 7'						97.25
4' x 8'						114.45
725 Press-on Weatherstrip Sponge Neoprene	Charcoal		0.98			Pemko: P493 ANSI: ROC156
726 Press-on Weatherstrip Smoke Seal						NGP: 5050 Pemko: S88 ANSI: ROE154
17'	Brown					25.05
18'	Charcoal					27.30
19'	Tan					28.35
20'	White					29.50
21'						31.85
22'						33.40
25'						37.90
260'						374.20
520'						748.40

Thresholds and Weatherstripping

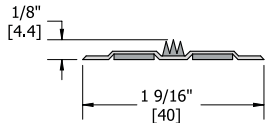
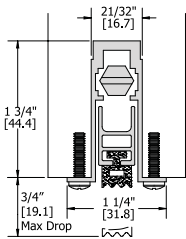
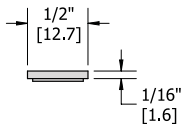
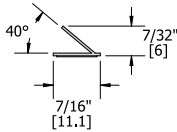
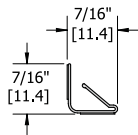

Description	Finish	Without Insert		With Insert			Comparison Numbers
		Insert	N	S	V	W	
727 Press-on Weatherstrip TPE material							NGP: PF180 ANSI: ROY156
7'	Charcoal		11.45				
8'			13.00				
3' x 7'			27.75				
4' x 8'			32.55				
728 Press-on Weatherstrip TPE							NGP: 5040 Pemko: S44 ANSI: R00154
17'	Charcoal			24.55			
20'				28.75			
21'				30.00			
25'				35.75			
260'				338.60			
520'				676.50			
729 Press-on Weatherstrip Edge Sealing System Intumescent material							NGP: 9800 Pemko: HSS2000 ANSI: ROW156
17'	Brown	33.50					
19'	Charcoal	37.30					
21'	White	41.30					
25'		49.15					
150'		288.85					
730S Automatic Door Bottom Mortise Application End Caps Furnished (max. drop 3/4")							NGP: 225 Pemko: 411 ANSI: R3Y326
12" to 23"							
24" to 36"	MIL		93.50	105.80			
37" to 48"	MIL		61.50	73.80			
49" to 60"	MIL		82.00	98.40			
	MIL		102.50	123.00			
734 Press-on Weatherstrip Edge Sealing System & Smoke Seal Intumescent material							NGP: 9550 ANSI: ROW154
7'	Brown	40.60					
8'	Charcoal	46.35					
9'		52.15					
3' x 7'		98.50					
6' x 7'		115.80					
8' x 8'		139.05					

Price Code: POA - Price on Application
 Insert Codes: V - Vinyl; N - Neoprene, EDPM, or TPE; S - Silicone; W - Pile; B - Nylon Brush; F - Vinyl Fin
 Finish Codes: MIL - Mill Finished Aluminum; DBA - Dark Bronze Anodized; GLD - Gold Anodized; MIB - Mill Finished Bronze; 32D - Matte Stainless Steel; GYP - Primed for Painting; CLR - Clear Anodized; CAL - Cast Aluminum

Thresholds and Weatherstripping

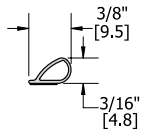

Description	Finish	Without Insert		With Insert		Comparison Numbers
		Insert	N	S	V	
736 Press-on Weatherstrip Smoke Seal						NGP: 2525 Pemko: PK33 ANSI: ROE154
	Charcoal			25.15		
	White			27.20		
				28.45		
				29.70		
				31.75		
				33.20		
				37.70		
				372.05		
				744.20		

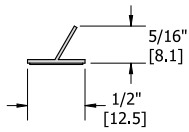

737 Press-on Weatherstrip Smoke Seal						NGP: 5060 Pemko: S77 ANSI: ROE154
	Charcoal			28.15		
				29.80		
				31.45		
				33.10		
				34.55		
				36.15		
				41.00		
				349.80		
				646.55		

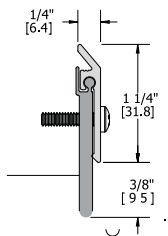

750S Door Bottom - Sweep						NGP: 200 Pemko: 315 ANSI: ROY436
	CLR	4.75	7.05			
	DBA	6.20	8.65			
	GLD	6.85	9.25			
	32D	28.70	31.85			

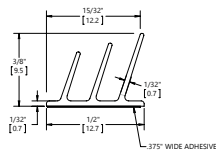

738 Press-on Weatherstrip Smoke Seal						NGP: 5075 Pemko: S773 ANSI: ROE154
	Charcoal			32.75		
				35.55		
				38.85		
				41.55		
				43.50		

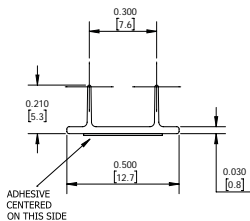

739 Press-on Weatherstrip Smoke Seal						NGP: 5070 Pemko: S772 ANSI: ROE154
	Brown			42.90		
	Clear			45.45		
				47.95		
				50.50		
				53.00		



Thresholds and Weatherstripping

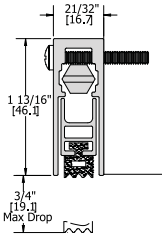

Description	Finish	Without Insert		With Insert		Comparison Numbers
		N	S	V	W	
740S Automatic Door Bottom - Surface Applied End Caps Furnished (max. drop 3/4")						NGP: 222 Pemko: 4131 ANSI: R3Y336
	12" to 23"	CLR	101.00	114.00		
		DBA	111.00	124.00		
		GLD	128.00	143.00		
	24" to 36"	CLR	68.75	81.50		
		DBA	78.50	91.75		
		GLD	96.00	111.00		
	37" to 48"	CLR	91.50	108.75		
		DBA	104.60	122.50		
		GLD	128.00	148.00		
	49" to 60"	CLR	114.60	135.90		
		DBA	130.75	153.25		
	GLD	160.00	185.00			

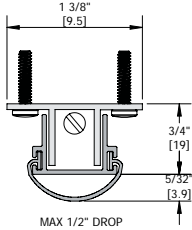

742S Automatic Door Bottom - Hollow Metal Door Application (max. drop 1/2")						NGP: 320 Pemko: 420
	24" to 36"	MIL		54.50		
	37" to 48"	MIL		72.50		
	49" to 60"	MIL		95.50		

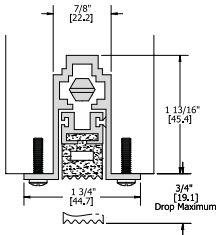

743S Automatic Door Bottom Mortise Application End Caps Furnished (max drop 3/4")						NGP: 422 Pemko: 434 ANSI: R3C326
	12" to 23"	MIL	131.00			
	24" to 36"	MIL	99.00			
	37" to 48"	MIL	132.00			
	49" to 60"	MIL	165.00			

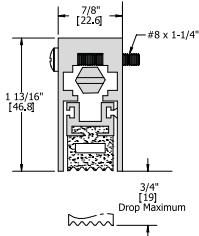

747S Automatic Heavy Duty Door Bottom - Surface Applied End Caps Furnished in Listed Furnishes (max. drop 3/4")						NGP: 420 Pemko: 4301 ANSI: R3C336
	12" to 23"	CLR	139.00			
		DBA	151.00			
		GLD	175.00			
	24" to 36"	CLR	106.50			
		DBA	118.50			
		GLD	143.75			
	37" to 48"	CLR	142.00			
		DBA	158.00			
		GLD	191.50			
	49" to 60"	CLR	177.50			
		DBA	197.50			
		GLD	239.50			



Thresholds and Weatherstripping

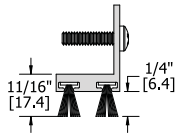

Description	Finish	Without Insert		With Insert		Comparison Numbers
		N	S	V	W	
751S Door Bottom - Shoe						NGP: 317 ANSI: R0Y436
	MIL	7.50	8.85	7.70	8.00	
	DBA	9.05	10.85	9.45	9.80	
	GLD	10.10	11.25	9.90	10.00	

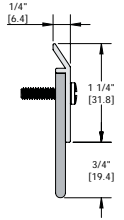

752S Door Bottom - Sweep						NGP: 102V ANSI: R3D436
	MIL			6.00		
	DBA			7.15		
	GLD			7.25		

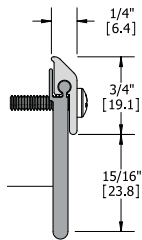

753S Door Bottom - Sweep						NGP: 114 Pemko: 3151 ANSI: R3B436
	MIL	7.05				
	DBA	8.10				
	GLD	8.75				

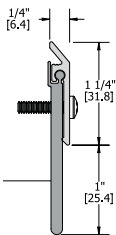

754S Door Bottom - Sweep						NGP: 197 Pemko: 3151 ANSI: R3B436
	CLR	7.15				
	DBA	9.35				
	GLD	10.10				

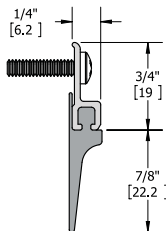

756S Door Bottom - Sweep or Astragal*						NGP: 97 Pemko: 307 ANSI: R3D434
	MIL			3.15		
	DBA			4.35		
	GLD			4.65		

*Order 2 for a set

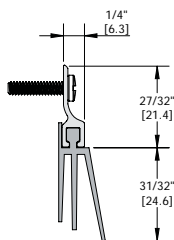

759S Door Bottom - Sweep						NGP: 96 Pemko: 57 ANSI: R3D436
	MIL			4.65		
	DBA			5.50		
	GLD			6.00		



Thresholds and Weatherstripping

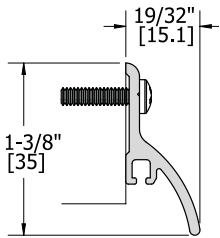

Description	Finish	Without Insert		With Insert		Comparison Numbers
		Insert	N	S	V	
770S						NGP: 17
Door Bottom - Sweep w/ Rain Drip	MIL	2.85	6.85		4.55	NGP: 101
	DBA	5.05	8.40		6.00	NGP: C627
	GLD	5.60	8.65		6.65	Pemko: 345 ANSI: R3Y534

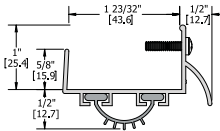

778S						NGP: 319E
Door Bottom - Shoe w/ Rain Drip	MIL		6.45		5.40	Pemko: 215
	DBA		8.30		6.95	ANSI: R3D536
	GLD		9.25		7.70	

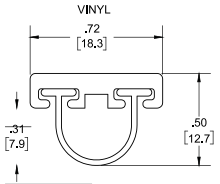

771S						NGP: 143
Astragal	MIL		10.85	11.25	10.40	10.00
	DBA		11.90	12.30	11.35	12.75

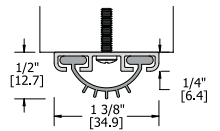

772S						NGP: 116
Door Bottom - Shoe or Astragal	MIL		6.75	7.15	6.95	6.65
	DBA		8.30	9.05	8.55	8.10
	GLD		8.90	9.35	8.85	8.40

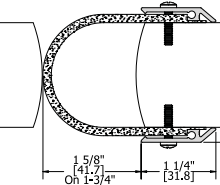

774S						NGP: 112
Door Bottom - Shoe or Astragal	MIL		4.45		3.70	Pemko: 234
	DBA		5.80		4.75	ANSI: R3Y725

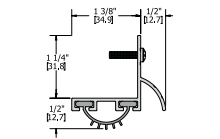

776S						NGP: 14RA
Door Bottom - Shoe or Astragal 1-3/4" Door	CLR		12.50			ANSI: R3C735
	DBA		14.85			

777S						NGP: 318
Door Bottom - Shoe w/ Rain Drip	MIL		6.45		5.40	Pemko: 210
	DBA		8.30		6.95	ANSI: R3D536
	GLD		9.25		7.70	

Price Code: POA - Price on Application
 Insert Codes: V - Vinyl; N - Neoprene, EDPM, or TPE; S - Silicone; W - Pile; B - Nylon Brush; F - Vinyl Fin
 Finish Codes: MIL - Mill Finished Aluminum; DBA - Dark Bronze Anodized; GLD - Gold Anodized; MIB - Mill Finished Bronze; 32D - Matte Stainless Steel; GYP - Primed for Painting; CLR - Clear Anodized; CAL - Cast Aluminum

Thresholds and Weatherstripping

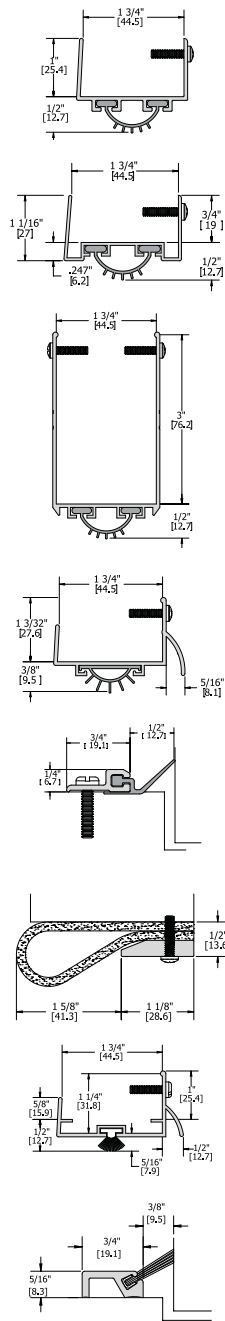

Description	Finish	Without Insert		With Insert		Comparison Numbers
		N	S	V	W	
779S Door Bottom - Shoe	MIL	6.45		5.40		NGP: 36 Pemko: 217
	DBA	8.30		6.95		ANSI: R3D436
	GLD	9.25		7.70		
780S Door Bottom - Shoe	MIL	7.80		6.55		NGP: 35 Pemko: 222
	DBA	10.10		8.40		ANSI: R3D436
	GLD	11.35		9.45		
782S Door Bottom - Shoe	MIL	17.25		14.20		NGP: 99 Pemko: 221
	DBA	22.20		18.50		ANSI: R3D436
	GLD	23.75		21.35		
783S Door Bottom - Shoe w/ Rain Drip Low Profile	MIL			5.35		NGP: 319E ANSI: R3D536
	DBA			7.55		
	GLD			8.10		
785S Jamb Weatherstrip up to 96"	MIL	4.50				NGP: 188 ANSI: R3D164
	DBA	6.50				
	GLD	6.95				
787S Garage Weatherstrip	MIL	39.50				NGP: 81369 Pemko: E199
						ANSI: R3D016
789S Door Bottom Rain Drip	MIL				9.70	
	DBA				14.00	
	GLD				14.60	
800S Jamb Weatherstrip	MIL	5.80				NGP: A626A Pemko: 45041
	DBA	8.30				ANSI: R3F164
	GLD	8.95				

Thresholds and Weatherstripping

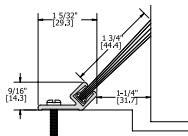
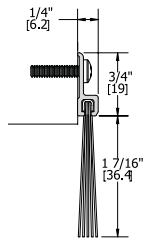
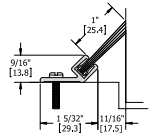
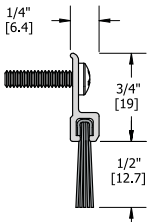
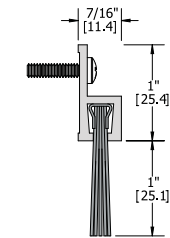

Description	Finish	B	N	With Insert		W	Comparison Numbers
				S	V		
8015 Door Sweep or Jamb Weatherstrip or Astragal*	MIL	6.75					NGP: D608 Pemko: 18100 ANSI: R3D434
	DBA	8.75					
	GLD	8.85					
*Order 2 for a set							
8025 Door Sweep or Jamb Weatherstrip or Astragal*	MIL	4.35					NGP: B606 Pemko: 18061 ANSI: R3F164
	DBA	5.70					
	GLD	6.10					
*Order 2 for a set							
8035 Jamb Weatherstrip	MIL	7.25					NGP: D620 Pemko: 45100 ANSI: R3F164
	DBA	8.65					
	GLD	9.25					
8065 Door Sweep	MIL	9.60					Pemko: 18137 ANSI: R3F436
	DBA	13.80					
	GLD	14.30					
808S Jamb Weatherstrip	MIL	12.75					NGP: G622 Pemko: 45175 ANSI: R3F164
	DBA	17.75					
	GLD	18.20					

Price Code: POA - Price on Application
 Insert Codes: V - Vinyl; N - Neoprene, EDPM, or TPE; S - Silicone; W - Pile; B - Nylon Brush; F - Vinyl Fin
 Finish Codes: MIL - Mill Finished Aluminum; DBA - Dark Bronze Anodized; GLD - Gold Anodized; MIB - Mill Finished Bronze; 32D - Matte Stainless Steel; GYP - Primed for Painting; CLR - Clear Anodized; CAL - Cast Aluminum

Thresholds and Weatherstripping

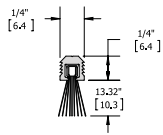
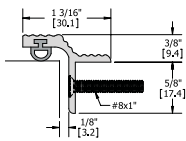
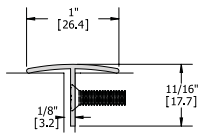
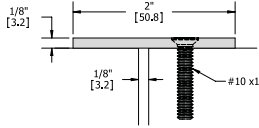
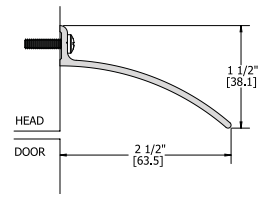

Description	Finish	Without Insert		With Insert			Comparison Numbers
		Insert	N	S	V	W	
810S Overhead Rain Drip	MIL	5.05					NGP: 16
	DBA	6.85					Pemko: 346
	GLD	7.90					ANSI: R3Y036
835S Astragal - Bar Type 10' Max length	MIL	6.55					NGP: 139
	DBA	8.30					Pemko: 357
	GLD	9.35					ANSI: ROY636
	GYP	6.75					
	32D	29.75					
836S Astragal T-Type	MIL	5.60					NGP: 176
	DBA	7.50					Pemko: 359
	GLD	8.00					ANSI: R3Y616
837S Astragal T-Type	MIL		7.35	7.70	6.30	6.30	NGP: 158
	DBA		9.90	10.00	8.65	8.65	Pemko: 355
	GLD		10.30	10.30	9.15	9.15	ANSI: R3Y714
839S Kerf-in Mortise Astragal Sweep *Brush insert	MIL	4.75					Pemko: 5041AP
							ANSI: R3A425

Thresholds and Weatherstripping

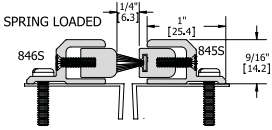
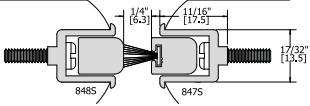
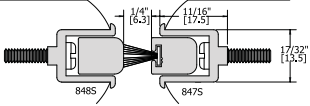
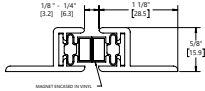
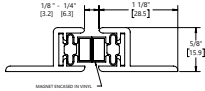
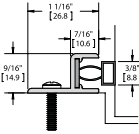
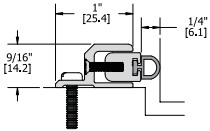
Description	Finish	Without Insert				With Insert				Comparison
		N	S	V	W	N	S	V	W	
 <p>8455 Astragal - Surface Applied Adjustable Spring Loaded w/ Pile Must also order 846 for a set.</p>	MIL									NGP: 140P Pemko: 351P
	DBA								17.05	
	GLD								20.40	22.05
 <p>8465 Astragal - Surface Applied Adjustable Spring Loaded Must also order 845 for a set</p>	MIL	16.60								NGP: 140P Pemko: 351P
	DBA	19.85								
	GLD	21.85								
 <p>8475 Astragal - Mortise Type Adjustable Spring Loaded w/ Pile Must also order 848 for a set</p>	MIL						16.10			NGP: 144P Pemko: 354P
	DBA						20.10			
	GLD						22.30			
 <p>8485 Astragal - Mortise Type Adjustable Spring Loaded Must also order 847 for a set</p>	MIL	16.20								NGP: 144P Pemko: 354P
	DBA	20.30								
	GLD	22.60								
 <p>8495 Adjustable Astragals Magnetic 80" to 96" Doors only (sold as set ONLY)</p>	MIL	42.85								NGP: 149MA ANSI: R3L835
	DBA	51.45								
 <p>8595 Magnetic Weatherstrip</p>	MIL	9.15								NGP: 159M Pemko: 2815 ANSI: R3L264
	DBA	11.35								
 <p>8605 Jamb Weatherstrip Adjustable</p>	MIL	16.50	17.05	16.00	16.00					NGP: 106 Pemko: 351 ANSI: R3B264
	DBA	19.75	20.40	19.15	19.15					
	GLD	20.90	21.55	20.30	20.30					

Price Code: POA - Price on Application
 Insert Codes: V - Vinyl; N - Neoprene, EDPM, or TPE; S - Silicone; W - Pile; B - Nylon Brush; F - Vinyl Fin
 Finish Codes: MIL - Mill Finished Aluminum; DBA - Dark Bronze Anodized; GLD - Gold Anodized; MIB - Mill Finished Bronze; 32D - Matte Stainless Steel; GYP - Primed for Painting; CLR - Clear Anodized; CAL - Cast Aluminum

Thresholds and Weatherstripping

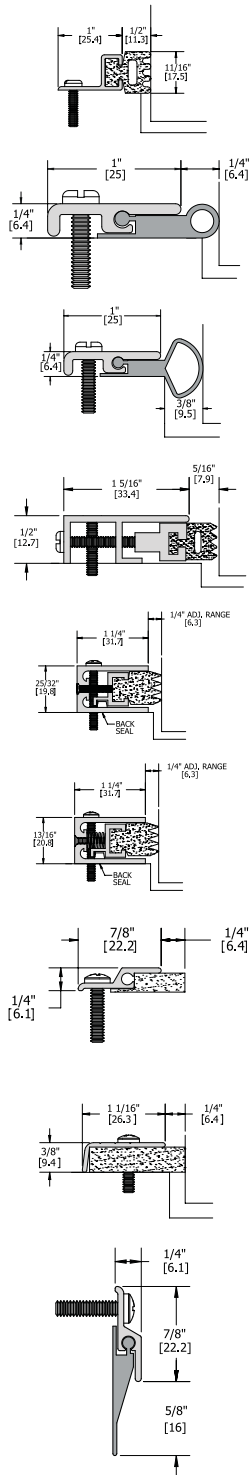

Description	Finish	Without Insert			With Insert			Comparison
		N	S	V	W			
861S Jamb Weatherstrip	MIL	8.30				NGP: 108		
	DBA	9.60				Pemko: 285		
	GLD	10.40				ANSI: R3C164		
862S Jamb Weatherstrip	CLR	6.45				NGP: 137		
	DBA	7.35				Pemko: 319		
	GLD	8.10				ANSI: R3B164		
863S Jamb Weatherstrip	CLR	7.15				ANSI: R3B164		
	DBA	8.40						
	GLD	8.75						
864S Adjustable Jamb Weatherstrip	CLR	11.90				NGP: 107		
	DBA	14.85				Pemko: 379		
	GLD	15.35				ANSI: R3C164		
865S Adjustable Jamb Weatherstrip	MIL	16.30				NGP: 103N		
	DBA	19.15				Pemko: 350		
	GLD	20.20				ANSI: R3C264		
866S Adjustable Spring Loaded Jamb Weatherstrip	MIL	17.05				NGP: 303N		
	DBA	20.20				ANSI: R3C264		
870S Jamb Weatherstrip	CLR	4.00				NGP: 127		
	DBA	5.15				NPG: 120SS		
	GLD	6.10				Pemko: 305		
						ANSI: ROC164		
871S Jamb Weatherstrip	MIL	5.70				NGP: 132N		
	DBA	7.25				Pemko: 368		
	GLD	7.50				ANSI: R3C164		
872S Door Bottom Sweep or Astragal Order 2 for set	CLR	5.70				NGP: 115		
	DBA	6.65				Pemko: 305		
	GLD	7.70				ANSI: ROB634		

Thresholds and Weatherstripping

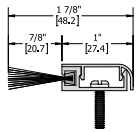
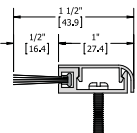
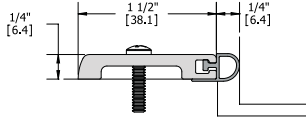
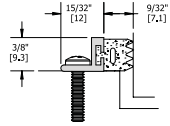
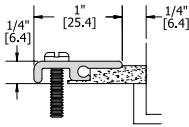
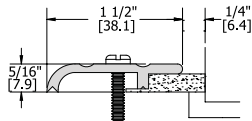
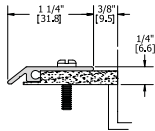
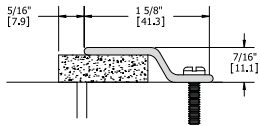
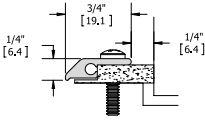

Description	Finish	Without Insert				With Insert			Comparison
		N	S	V	W				
873S Jamb Weatherstrip	MIL	4.35						NGP: 110 Pemko: 332 ANSI: R3C164	
	DBA	5.60							
	GLD	6.45							
874S Astragal/Jamb Weatherstrip	MIL	6.55						NGP: 109 Pemko: 375 ANSI: R3C164	
	DBA	8.85							
	GLD	9.60							
	32D	33.95							
875S Jamb Weatherstrip	CLR	5.15	6.95					NGP: 130 Pemko: 315 ANSI: ROY134	
	DBA	6.45	8.65						
	GLD	7.15	9.35						
877S Jamb Weatherstrip	MIL	6.10						ANSI: R3C164 NGP: 133	
	DBA	7.60							
	GLD	8.55							
878S Jamb Weatherstrip	CLR	4.85						NGP: 134 Pemko: 312 ANSI: R3C164	
	DBA	5.60							
	GLD	5.80							
880S Jamb Weatherstrip	MIL	4.55						NGP: 165 Pemko: 296 ANSI: R3C164	
	DBA	6.10							
	GLD	6.55							
881S Jamb Weatherstrip Hardware Compatible	MIL	6.95	7.50	6.20	8.00			NGP: 700E Pemko: 290 ANSI: R3Y164	
	DBA	8.75	9.35	7.70	9.90				
	GLD	9.70	10.40	8.65	11.15				
Description	Finish	B	N	With Insert		W	Comparison Numbers		
882S Door Sweep, Astragal or Jamb Weatherstrip with Snap Cover	CLR	6.75					NGP: 675 Pemko: 29326 ANSI: R3Y164		
	DBA	9.35							
	GLD	10.00							
883S Door Sweep with Snap Cover	CLR	8.00					NGP: 678 Pemko: 293100 ANSI: R3Y164		
	DBA	10.30							
	GLD	11.15							

Price Code: POA - Price on Application
 Insert Codes: V - Vinyl; N - Neoprene, EDPM, or TPE; S - Silicone; W - Pile; B - Nylon Brush; F - Vinyl Fin
 Finish Codes: MIL - Mill Finished Aluminum; DBA - Dark Bronze Anodized; GLD - Gold Anodized; MIB - Mill Finished Bronze; 32D - Matte Stainless Steel; GYP - Primed for Painting; CLR - Clear Anodized; CAL - Cast Aluminum



Thresholds and Weatherstripping

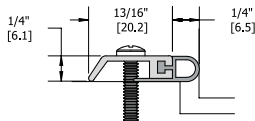
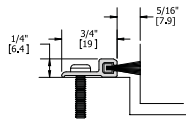
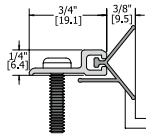
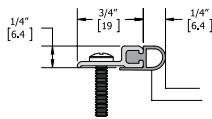
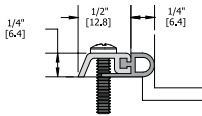
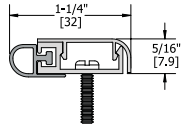
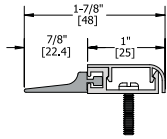

Description	Finish	F	N	With Insert		W	Comparison Numbers
				S	V		
8845 Astragal, Door Sweep with Snap Cover	CLR DBA GLD				6.45 8.00 8.55		ANSI: R3Y164
8855 Jamb Weatherstrip with Snap Cover	CLR DBA GLD	6.00 8.75 9.25	6.75 9.35 10.00	7.25 10.10 10.50	6.00 8.75 9.25	6.65 9.25 9.75	NGP: 170 Pemko: 29310 ANSI: R3Y164
8905 Jamb Weatherstrip	MIL DBA GLD		2.45 3.70 3.80	3.05 4.75 4.85	1.70 2.85 2.95		NGP: 152 Pemko: 316 ANSI: R3Y164
8915 Jamb Weatherstrip	MIL DBA GLD	1.70 2.85 2.95	2.45 3.70 3.80	3.05 4.75 4.85	1.70 2.85 2.95		NGP: 160 Pemko: 303 ANSI: R3Y164
8925 Jamb Weatherstrip Insert: Gray Neoprene	MIL DBA GLD		2.65 4.10 4.20				Pemko: 294 ANSI: R3B164
8935 Jamb Weatherstrip	MIL DBA GLD					2.85 4.30 4.45	NGP: A605 Pemko: 309 ANSI: R3F164
8965 Jamb Weatherstrip	MIL DBA GLD		2.45 3.70 3.80	3.05 4.75 4.85	1.70 2.85 2.95		NGP: 156 Pemko: 297 ANSI: R3Y164

Thresholds and Weatherstripping

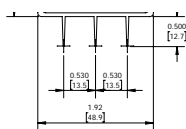
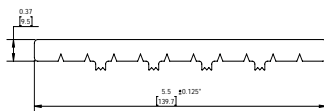
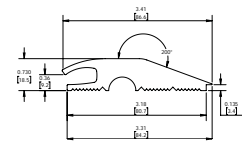
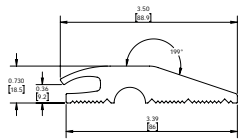
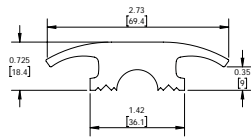
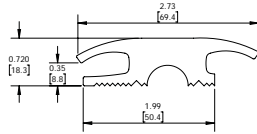
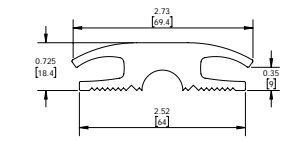

Description	Size	Finish	Without Insert	With Insert V	Comparison Numbers
900S Vinyl Threshold Carpet to Carpet	36" 48"	Black Black	38.35 51.05		NGP: 401 Pemko: EV2322BL
901S Vinyl Threshold Carpet to Tile	36" 48"	Black Black	40.45 53.90		NGP: 402 Pemko: EV2325BL
902S Vinyl Threshold Tile to Tile	36" 48"	Black Black	38.35 51.05		NGP: 407 Pemko: EV2326BL
903S Vinyl Threshold Carpet	36" 48"	Black Black	40.45 53.90		NGP: 398 Pemko: EV2320BL
904S Vinyl Threshold Carpet to Tile	36" 48"	Black Black	41.10 54.75		NGP: 399 Pemko: EV2322BL
905S Vinyl Threshold Transition	36" 48"	Black Black	52.30 69.85		NGP: 400
906S Door Bottom - Shoe Triple Fin (Unnotched)	36" 48"	Brown Brown		24.30 32.35	NGP: 344 Pemko: 2170
Triple Fin (Notched)	36" 48"	Brown Brown		33.10 44.10	

Price Code: POA - Price on Application
 Insert Codes: V - Vinyl; N - Neoprene, EDPM, or TPE; S - Silicone; W - Pile; B - Nylon Brush; F - Vinyl Fin
 Finish Codes: MIL - Mill Finished Aluminum; DBA - Dark Bronze Anodized; GLD - Gold Anodized; MIB - Mill Finished Bronze; 32D - Matte Stainless Steel; GYP - Primed for Painting; CLR - Clear Anodized; CAL - Cast Aluminum



Thresholds and Weatherstripping

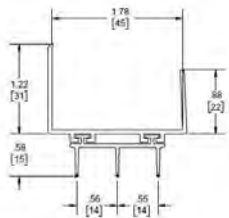
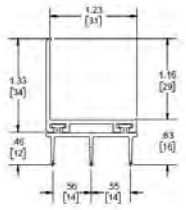
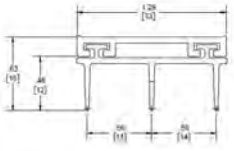

Description	Size	Finish	Without Insert	With Insert V	Comparison Numbers
907S					
Door Bottom - Shoe Triple Fin - Unnotched	36"	MIL		5.60	NGP: 12T Pemko: 2343UN
		DBA		6.85	
		GLD		9.90	NGP: 12T Pemko: 2343
Door Bottom - Shoe Triple Fin- Notched	48"	MIL		8.35	
		DBA		9.65	
		GLD		11.40	
908S					
Door Bottom - Shoe Triple Fin - Unnotched	36"	MIL		8.25	NGP: 13T Pemko: 2113UN
		DBA		10.60	
		GLD		12.45	NGP: 13TNF Pemko: 2113
		CLR		8.95	
Door Bottom - Shoe Triple Fin- Notched	48"	MIL		11.40	
		DBA		14.20	
		GLD		16.10	
		CLR		12.30	
909S					
Door Bottom - Shoe Triple Fin - Unnotched	36"	MIL		8.85	NGP: 36ET Pemko: 2143UN
		DBA		11.25	
		GLD		13.40	NGP: 36ETNF Pemko: 2173
Door Bottom - Shoe Triple Fin- Notched	48"	CLR		9.30	
		MIL		11.55	
		DBA		13.95	
		GLD		16.90	
		CLR		12.60	

Thresholds

Thresholds

400S 36" DBA VINYL057047
401S 36" DBA069704
401S 36" MIL051003
401S 72" SCA134225
402S 36" MIL051415
403S 36" DBA054097
403S 36" MIL	051829
403S 36" SCA007258
403S 48" MIL051420
403S 72" MIL051422
403S 72" DBA054098
404S 36" DBA053510
404S 36" MIL	051423
404S 48" DBA058788
404S 48" MIL	051424
404S 72" MIL	051426
404S 96" MIL053016
406S 36" MIL051431
406S 72" GLD025728
406S 72" MIL051434
407S 36" DBA069696
407S 36" GLD022070
407S 36" MIL051435
407S 48" MIL051436
407S 72" GLD082336
407S 96" MIL077245
410S 36" DBA058997
410S 36" MIL	051009
410S 48" DBA061578
410S 48" MIL051011
410S 72" DBA061579
410S 72" GLD038946
410S 72" MIL	051013
410S 96" MIL056399
412S 36" DBA	053693
412S 36" GLD053738
412S 36" MIL	051021
412S 36" MIL WSPA091344
412S 36" SCA055441
412S 36" SCB017067
412S 48" DBA054063
412S 48" MIL	051023
412S 48" SCA074258
412S 72" DBA053067
412S 72" GLD063301
412S 72" MIL	051025

Thresholds and Weatherstripping - Stock Numbers

Thresholds

412S 72" SCA060167
412S 72" SCB129267
412S 96" GLD055211
412S 96" MIL052764
413S 36" US3052029
413S 36" US32D025717
413S 36" DBA015900
413S 36" MIL	051027
413S 48" US32D039101
413S 48" DBA065227
413S 48" MIL	051029
413S 72" US3052031
413S 72" US32D023441
413S 72" DBA054295
413S 72" MIL	051031
413S 96" US3052032
413S 96" MIL054157
414S 36" DBA000955
414S 36" MIL051451
414S 72" DBA117097
415S 36" DBA057305
415S 36" MIL	051033
415S 36" SCA071687
415S 48" DBA023733
415S 48" MIL	051035
415S 72" MIL	051037
416S 36" DBA060723
416S 36" GLD081665
416S 36" MIL051051
416S 36" SCA090216
416S 48" DBA063049
416S 48" MIL051053
416S 72" DBA016047
416S 72" MIL051055
416S 96" MIL052960
417S 36" DBA059553
417S 36" MIL	056494
417S 36" SCA058889
417S 48" DBA024802
417S 48" MIL057023
417S 72" DBA075007
417S 72" MIL057024
417S 96" MIL060172
418S 36" MIL	056495
418S 48" MIL062685
418S 72" MIL059607

Items with the price in **bold and red** are Quick Ship Items and ship in 24 hours.



Thresholds

418S 96" MIL066488
419S 36" MIL056496
419S 48" DBA	108927
420S 36" MIL061332
420S 48" MIL030506
420S 72" MIL073999
421S 36" MIL059872
421S 72" DBA068739
421S 72" MIL064918
422S 36" MIL064486
422S 48" MIL085099
422S 72" MIL064485
423S 72" MIL082531
424S 36" MIL066013
424S 48" MIL095418
426S 36" DBA002015
426S 36" MIL061695
426S 48" MIL077225
426S 72" MIL064254
426S 96" MIL064253
427S 36" MIL061190
427S 48" MIL061133
427S 72" MIL061125
427S 96" DBA	134871
428S 36" MIL069001
428S 48" MIL030450
428S 72" DBA066973
428S 72" MIL059870
428S 96" DBA021942
430S 36" MIL062855
430S 48" MIL088799
430S 72" DBA095313
430S 72" MIL070161
430S 72" SCA084515
431S 36" DBA070641
431S 36" GLD048973
431S 36" MIL051455
431S 48" DBA078959
431S 48" MIL051456
431S 72" DBA055522
431S 72" GLD066756
431S 72" MIL051458
431S 96" MIL096450
432S 36" DBA059786
432S 36" MIL053172
432S 48" US10B095706

Thresholds

432S 48" MIL062853
432S 72" US10B095703
432S 72" DBA057872
432S 72" MIL053822
433S 36" DBA054825
433S 36" GLD058459
433S 36" MIL051463
433S 48" MIL051464
433S 72" DBA063629
433S 72" GLD062034
433S 72" MIL051466
434S 36" MIL052038
434S 36" MIL NEOPRENE026655
434S 36" MIL SILICONE031084
434S 36" MIL VINYL056329
435S 36" GLD	106702
435S 36" MIL NEOPRENE028335
435S 72" MIL NEOPRENE080550
435S 36" MIL VINYL056497
435S 72" MIL VINYL056644
436S 36" DBA038944
436S 36" MIL027686
436S 48" DBA093704
436S 48" MIL023620
436S 72" DBA075861
436S 72" MIL032198
436S 96" MIL054106
438S 36" DBA046790
438S 36" MIL013799
438S 72" DBA045585
442S 36" MIL065007
442S 36" SCA071626
442S 48" MIL063483
442S 72" MIL086139
443S 36" MIL065346
444S 36" MIL089632
444S 48" MIL094554
445S 72" MIL051471
445S 96" MIL062261
448S 36" DBA117092
448S 36" MIL038781
448S 48" MIL111712
448S 72" DBA130861
448S 72" MIL037440
448S 96" MIL066757
448S 96" MIL NH	139421

Thresholds

Thresholds

450S 48" MIL	.051473
450S 96" MIL	.012758
451S 48" MIL	.098765
451S 72" MIL	.073016
452S 72" MIL	.092409
455S 96" MIL	.070042
460S 72" MIL	.051483
460S 96" MIL	.075035
465S 72" MIL	.051488
470S 36" MIL	.051492
470S 72" MIL	.051494
477S 48" DBA	.144656
477S 48" MIL NEOPRENE	.025060
477S 36" MIL VINYL	.089975
477S 48" DBA VINYL	.021980
477S 48" MIL VINYL	.017278
477S 72" MIL VINYL	.094703
478S 36" MIL	.144368
478S 36" GLD SILICONE	.088825
481S 36" MIL NEOPRENE	.055791
481S 48" MIL NEOPRENE	.076605
481S 72" MIL NEOPRENE	.055980
481S 36" MIL SILICONE	.072476
481S 36" DBA VINYL	.006126
481S 36" MIL VINYL	.056073
481S 48" DBA VINYL	.036999
481S 48" MIL VINYL	.051940
481S 72" DBA VINYL	.050881
481S 72" MIL VINYL	.054902
484S 36" DBA	.079872
484S 36" MIL	.051516
484S 48" DBA	.040821
484S 48" MIL	.051517
484S 72" DBA	.050882
484S 72" MIL	.051519
484S 96" MIL	.088497
492S 36" MIL	.032347
504S 36" MIL	.051534
504S 72" MIL	.056390
505S 36" MIL	.051542
506S 36" BLA	.052729
506S 36" MIL	.054719
508S 36" DBA	.020721
508S 36" MIL	.034315
516S 36" MIL	.124421
516S 72" MIL	.128226

Thresholds and Weatherstripping - Stock Numbers

Thresholds

516S 36" MIL NEOPRENE	.034721
516S 36" MIL SILICONE	.064022
516S 36" MIL VINYL	.033033
516S 72" MIL VINYL	.034574
520S 36" MIL	.033055
520S 72" MIL	.051539
520S 36" MIL NEOPRENE	.054613
520S 48" MIL NEOPRENE	.056182
520S 72" MIL NEOPRENE	.055935
520S 72" SCA NEOPRENE	.046841
520S 36" MIL SILICONE	.064059
520S 48" MIL SILICONE	.080333
520S 72" MIL SILICONE	.064061
520S 36" DBA VINYL	.054218
520S 36" MIL VINYL	.051061
520S 36" SCA VINYL	.001850
520S 36" SCB VINYL	.120773
520S 48" DBA VINYL	.079046
520S 48" MIL VINYL	.051062
520S 72" DBA VINYL	.054454
520S 72" MIL VINYL	.051066
520S 72" SCA VINYL	.017347
520S 72" SCB VINYL	.120774
520S 96" MIL VINYL	.057442
532S 36" MIL	.051548
532S 36" DBA NEOPRENE	.071073
532S 36" MIL SILICONE	.073124
532S 72" MIL SILICONE	.054919
532S 36" MIL VINYL	.051552
532S 48" MIL VINYL	.051830
532S 72" VINYL	.062282
532S 72" MIL VINYL	.051555
532S 96" MIL VINYL	.053837
541S 36" MIL NEOPRENE	.054211
541S 48" DBA NEOPRENE	.000896
541S 48" MIL NEOPRENE	.054059
541S 72" MIL NEOPRENE	.054060
541S 36" CLR VINYL	.095393
541S 36" DBA VINYL	.053658
541S 36" MIL VINYL	.051068
541S 48" CLR VINYL	.095382
541S 48" MIL VINYL	.051070
541S 72" MIL VINYL	.051074
552S 36" 32D VINYL	.108523
552S 36" MIL VINYL	.051568
552S 48" MIL VINYL	.051569



Thresholds

552S 96" MIL VINYL057479
560S 36" MIL VINYL051076
560S 36" MIL VINYL NH008752
560S 48" MIL VINYL051078
560S 48" MIL VINYL NH012801
560S 72" MIL VINYL051082
560S 72" MIL VINYL NH009223
565S 36" SCA NEOPRENE145379
565S 48" MIL NEOPRENE008593
565S 48" SCA NEOPRENE145380
565S 36" MIL VINYL057025
565S 36" SCA VINYL137796
565S 48" SCA VINYL137797
572S 36" DBA025594
572S 72" MIL030908
575S 36" DBA VINYL052358
575S 36" MIL VINYL051084
575S 48" MIL VINYL051086
575S 72" MIL VINYL051090
575S 96" MIL VINYL052982
580S 36" MIL VINYL021041
599S 48" DBA VINYL134849
600S 36" MIL051584
600S 48" MIL022772
603S 36" US10B076299
603S 36" US3104453
603S 36" DBA078404
603S 36" MIL051590
603S 48" MIL051591
603S 72" DBA098807
604S 36" DBA053623
604S 36" MIL051592
604S 36" SCA071847
604S 48" DBA074415
604S 48" MIL051593
604S 72" US3048329
604S 72" DBA068183
604S 72" MIL063979
604S 72" SCA094430
604S 96" MIL062565
859S 36" DBA021458
859S 36" MIL031358

Press-On Weatherstripping

7/1/2019 BLACK094197
726B 204" BROWN	108247
726B 216" BROWN141854

Press-On Weatherstripping

726B 240" BROWN	110396
726B 252" BROWN103765
726B 300" BROWN137455
726S 204" CHARCOAL	052216
726S 216" CHARCOAL	052583
726S 240" CHARCOAL	052217
726S 252" CHARCOAL	052437
726S 260-FT CHARCOAL053002
726S 264" CHARCOAL052582
726S 300" CHARCOAL052737
726S 520-FT CHARCOAL	053070
726T 204" TAN068315
726T 240" TAN068312
726T 252" TAN139885
726W 204" WHITE054222
726W 216" WHITE054799
726W 240" WHITE054223
726W 252" WHITE054224
726W 260-FT WHITE054226
726W 264" WHITE060177
726W 300" WHITE054225
726W 520-FT WHITE054227
728S 204" CHARCOAL048276
728S 216" CHARCOAL051094
728S 240" CHARCOAL049528
728S 252" CHARCOAL061881
728S 260-FT CHARCOAL047334
728S 264" CHARCOAL061882
728S 300" CHARCOAL064421
728S 520-FT CHARCOAL002601
729B 204" BROWN045920
729B 216" BROWN055100
729B 252" BROWN046133
729B 300" BROWN079208
729S 204" BLACK015885
729S 252" BLACK068776
729S 300" BLACK068777
729W 204" WHITE024763
729W 252" WHITE027429
729W 300" WHITE027430
736S 204" CHARCOAL	089698
736S 216" CHARCOAL093251
736S 240" CHARCOAL	096054
736S 252" CHARCOAL096055
736S 260-FT CHARCOAL095015
736S 264" CHARCOAL098132

Thresholds

Press-On Weatherstripping

736S 300" CHARCOAL090886
736S 520-FT CHARCOAL095014
736W 204" WHITE096056
736W 216" WHITE098957
736W 240" WHITE096057
736W 252" WHITE096088
736W 260-FT WHITE095017
736W 264" WHITE046032
736W 300" WHITE096033
736W 520-FT WHITE095016
737S 204" CHARCOAL035450
737S 216" CHARCOAL035449
737S 240" CHARCOAL035447
737S 252" CHARCOAL035422
737S 260-FT CHARCOAL035383
737S 264" CHARCOAL035393
737S 300" CHARCOAL035392
737S 520-FT CHARCOAL035382
719B 36" x 84" BROWN082481
719B 48" x 84" BROWN085139
719B 72" x 84" BROWN082483
719B 84" BROWN082511
719B 84" x 84" BROWN082484
719B 96" BROWN082514
719B 108" BROWN082515
719S 36" x 84" CHARCOAL082491
719S 48" X 84" CHARCOAL085084
719S 72" x 84" CHARCOAL082494
719S 84" CHARCOAL082522
719S 84" x 84" CHARCOAL082496
719S 96" CHARCOAL082524
719S 108" CHARCOAL082525
720B 36" x 84" BROWN FLEX INTUMESCENT SINGLE WING107435
720B 48" X 84" BROWN FLEX INTUMESCENT SINGLE WING107433
720B 72" X 84" BROWN FLEX INTUMESCENT SINGLE WING107434
720B 84" x 84" BROWN FLEX INTUMESCENT SINGLE WING112842
720S 36" x 84" CHARCOAL FLEX INTUM SINGLE WING105952
720S 48" X 84" CHARCOAL FLEX INTUM SINGLE WING105953
720S 72" X 84" CHARCOAL FLEX INTUM SINGLE WING105954
720S 84" x 84" CHARCOAL FLEX INTUM SINGLE WING105955
720S 96" X 96" CHARCOAL FLEX INTUM SINGLE WING118211
721B 36" x 84" BROWN029485
721B 48" x 84" BROWN029488
721B 72" x 84" BROWN029491
721B 84" BROWN047510
721B 84" x 84" BROWN143529

Thresholds and Weatherstripping - Stock Numbers

Press-On Weatherstripping

721B 96" BROWN047517
721B 108" BROWN047518
721G 36" x 84" GREY013457
721G 48" x 84" GREY108615
721G 72" x 84" GREY089314
721G 84" GREY087654
721G 96" GREY087652
721S 36" x 84" BLACK029493
721S 48" x 84" CHARCOAL029494
721S 72" x 84" CHARCOAL029496
721S 84" CHARCOAL081187
721S 84" x 84" CHARCOAL000002
721S 96" CHARCOAL081186
721S 96" x 96" CHARCOAL142009
721S 108" CHARCOAL081735
721W 36" x 84" WHITE029520
721W 48" x 84" WHITE029521
721W 72" x 84" WHITE029523
721W 84" WHITE059248
721W 84" x 84" WHITE074859
721W 96" WHITE059123
721W 108" WHITE059122
722B 36" x 84" BROWN086961
722B 48" x 84" BROWN086929
722B 72" x 84" BROWN086793
722B 84" x 84" BROWN086791
722B 96" x 96" BROWN086780
722S 36" x 84" CHARCOAL087124
722S 48" x 84" CHARCOAL087063
722S 72" x 84" CHARCOAL087055
722S 84" x 84" CHARCOAL087054
722S 96" x 96" CHARCOAL087005
724B 36" x 84" BROWN047696
724B 48" x 84" BROWN138515
724B 72" x 84" BROWN086997
724B 84" BROWN047527
724B 96" BROWN047528
724S 36" x 84" CHARCOAL089572
724S 84" CHARCOAL061283
724S 84" x 84" CHARCOAL109589
724S 96" CHARCOAL000241
724S 108" CHARCOAL014723
727S 36" x 84" CHARCOAL051140
727S 72" x 84" CHARCOAL054064
727S 84" CHARCOAL051139
727S 96" CHARCOAL053646



Press-On Weatherstripping

734S 36" X 84" BROWN026246
734B 72" X 84" BROWN026201
734B 84" BROWN026247
734B 96" BROWN026244
734B 96" X 96" BROWN026200
734B 108" BROWN026211
734S 36" X 84" CHARCOAL026327
734S 72" X 84" CHARCOAL026322
734S 84" CHARCOAL026357
734S 96" CHARCOAL026330
734S 96" X 96" CHARCOAL026321
734S 108" CHARCOAL026329
725S 84" NEOPRENE060206
725S 96" NEOPRENE060504
738S 204" CHARCOAL164037
738S 240" CHARCOAL164039

Auto-Door Bottoms

730S 36" MIL NEOPRENE	072966
730S 36" MIL NEOPRENE	051857
730S 42" MIL NEOPRENE054841
730S 48" MIL NEOPRENE051390
730S 36" MIL SILICONE	046487
730S 42" MIL SILICONE034849
730S 48" MIL SILICONE087236
740S 36" NEOPRENE076463
740S 36" CLR NEOPRENE	055452
740S 36" DBA NEOPRENE052434
740S 36" GLD NEOPRENE057701
740S 42" CLR NEOPRENE085096
740S 42" DBA NEOPRENE059866
740S 42" GLD NEOPRENE074922
740S 48" NEOPRENE080708
740S 48" CLR NEOPRENE087513
740S 48" DBA NEOPRENE052435
740S 48" GLD NEOPRENE066177
740S 36" CLR SILICONE068926
740S 42" CLR SILICONE069035
740S 48" CLR SILICONE068927
742S 36" MIL VINYL	053529
742S 42" MIL VINYL058976
742S 48" MIL VINYL053865
743S 36" MIL NEOPRENE	052842
743S 42" MIL NEOPRENE056039
743S 48" MIL NEOPRENE053078
747S 36" CLR NEOPRENE	053563
747S 36" DBA NEOPRENE053781

Auto-Door Bottoms

747S 36" GLD NEOPRENE016063
747S 42" CLR NEOPRENE087210
747S 42" DBA NEOPRENE057863
747S 48" CLR NEOPRENE084717
747S 48" DBA NEOPRENE053735
747S 48" GLD NEOPRENE058145

Door Bottoms & Sweeps

750S 36" US10B NEOPRENE010703
750S 36" US32D NEOPRENE023937
750S 36" CLR NEOPRENE	053564
750S 36" DBA NEOPRENE	053069
750S 36" GLD NEOPRENE052905
750S 42" US32D NEOPRENE037601
750S 42" CLR NEOPRENE053565
750S 42" DBA NEOPRENE064869
750S 42" GLD NEOPRENE071669
750S 48" US32D NEOPRENE076771
750S 48" CLR NEOPRENE	057658
750S 48" DBA NEOPRENE053013
750S 48" GLD NEOPRENE058143
750S 36" US32D SILICONE040289
750S 36" CLR SILICONE043444
750S 36" DBA SILICONE006348
750S 42" US32D SILICONE095058
750S 48" US32D SILICONE055864
750S 48" CLR SILICONE070213
752S 36" DBA VINYL015097
752S 36" GLD VINYL057972
752S 36" MIL VINYL	061376
752S 42" DBA VINYL027712
752S 42" MIL VINYL067894
752S 48" DBA VINYL040624
752S 48" GLD VINYL039647
752S 48" MIL VINYL007958
752S 48" MIL VINYL TEK078452
753S 36" DBA NEOPRENE061082
753S 36" GLD NEOPRENE077227
753S 36" MIL NEOPRENE	051337
753S 42" MIL NEOPRENE067110
753S 48" MIL NEOPRENE051338
754S 36" CLR NEOPRENE	083440
754S 36" DBA NEOPRENE052427
754S 42" CLR NEOPRENE083370
754S 42" DBA NEOPRENE005796
754S 48" CLR NEOPRENE	083372
756S 36" DBA VINYL054378

Door Bottoms & Sweeps

756S 36" GLD VINYL058375
756S 36" MIL VINYL	052010
756S 42" MIL VINYL061396
756S 48" DBA VINYL055418
756S 48" MIL VINYL	052011
759S 36" DBA VINYL027134
759S 36" GLD VINYL066852
759S 36" MIL VINYL060170
759S 42" DBA VINYL027167
759S 42" GLD VINYL104864
759S 42" MIL VINYL036002
759S 48" DBA VINYL066858
759S 48" GLD VINYL093917
759S 48" MIL VINYL032110
770S 36" MIL	051349
770S 36" DBA BRUSH065591
770S 36" GLD BRUSH040794
770S 36" MIL BRUSH	061333
770S 42" DBA BRUSH065066
770S 42" MIL BRUSH033809
770S 48" DBA BRUSH	046311
770S 48" MIL BRUSH084855
770S 36" VINYL075567
770S 36" DBA VINYL057644
770S 36" GLD VINYL055454
770S 36" MIL VINYL	054681
770S 42" GLD VINYL016288
770S 42" MIL VINYL067931
770S 48" DBA VINYL070746
770S 48" GLD VINYL038496
770S 48" MIL VINYL	063484
774S 36" NEOPRENE062304
774S 36" DBA NEOPRENE064438
774S 36" MIL NEOPRENE051357
774S 48" MIL NEOPRENE051358
774S 36" MIL VINYL051359
774S 48" DBA VINYL061377
774S 48" MIL VINYL051360
776S 42" CLR NEOPRENE094490
777S 36" DBA NEOPRENE035004
777S 36" MIL NEOPRENE027008
777S 36" DBA VINYL054611
777S 36" MIL VINYL051363
778S 36" DBA NEOPRENE015955
778S 36" MIL NEOPRENE015977
778S 48" DBA NEOPRENE058254

Door Bottoms & Sweeps

778S 36" VINYL062294
778S 36" DBA VINYL053780
778S 36" GLD VINYL055193
778S 36" MIL VINYL	051365
778S 42" DBA VINYL054862
778S 42" GLD VINYL062642
778S 42" MIL VINYL059750
778S 48" VINYL062641
778S 48" DBA VINYL054896
778S 48" MIL VINYL051366
779S 36" DBA NEOPRENE022886
779S 36" MIL NEOPRENE025961
779S 42" MIL NEOPRENE035071
779S 48" MIL NEOPRENE026920
779S 36" DBA VINYL057067
779S 36" GLD VINYL066396
779S 36" MIL VINYL054773
779S 42" DBA VINYL021025
779S 42" GLD VINYL068655
779S 42" MIL VINYL058978
779S 48" DBA VINYL012715
779S 48" GLD VINYL043164
779S 48" MIL VINYL057028
780S 36" MIL NEOPRENE027342
780S 48" MIL NEOPRENE029354
780S 36" DBA VINYL059252
780S 36" GLD VINYL086619
780S 36" MIL VINYL054821
780S 42" DBA VINYL053662
780S 42" MIL VINYL065433
780S 48" DBA VINYL071002
780S 48" MIL VINYL055420
782S 36" DBA NEOPRENE048578
782S 36" MIL NEOPRENE032350
782S 42" GLD NEOPRENE044501
782S 48" MIL NEOPRENE032330
782S 36" VINYL005870
782S 36" DBA VINYL034338
782S 36" GLD VINYL039678
782S 36" MIL VINYL	022288
782S 42" DBA VINYL014122
782S 42" MIL VINYL054861
782S 48" MIL VINYL034603
783S 36" MIL115282
783S 36" GLD VINYL098197
783S 36" MIL VINYL037956



Door Bottoms & Sweeps

783S 48" MIL VINYL037965
787S 36" MIL NEOPRENE055268
789S 36" DBA PILE044987
789S 36" GLD PILE032351
789S 36" MIL PILE036194
789S 42" MIL PILE036195
789S 48" MIL PILE036617
801S 36" DBA BRUSH059618
801S 36" GLD BRUSH063248
801S 36" MIL BRUSH	053035
801S 42" MIL BRUSH055943
801S 48" DBA BRUSH067890
801S 48" MIL BRUSH	054070
802S 36" DBA BRUSH	054610
802S 36" GLD BRUSH054786
802S 36" MIL BRUSH	053194
802S 42" GLD BRUSH052346
802S 42" MIL BRUSH065250
802S 48" DBA BRUSH061397
802S 48" GLD BRUSH067474
802S 48" MIL BRUSH	054074
806S 36" DBA BRUSH032352
806S 36" MIL BRUSH	035673
806S 48" DBA BRUSH029484
806S 48" MIL BRUSH031581
872S 36" CLR NEOPRENE095928

Jamb Weatherstripping

785S 36" MIL NEOPRENE120166
785S 36" x 84" MIL NEOPRENE120162
785S 36" x 96" GLD NEOPRENE120178
785S 36" x 96" MIL NEOPRENE122126
785S 48" DBA NEOPRENE122470
785S 72" x 84" DBA NEOPRENE120174
785S 72" x 84" MIL NEOPRENE120163
785S 84" DBA NEOPRENE120177
785S 84" GLD NEOPRENE120173
785S 84" MIL NEOPRENE120164
785S 96" DBA NEOPRENE120172
785S 96" MIL NEOPRENE120171
800S 36" MIL BRUSH054784
800S 36" x 84" MIL BRUSH051373
800S 48" x 84" MIL BRUSH051374
800S 72" x 84" MIL BRUSH051375
800S 72" x 96" MIL BRUSH019037
800S 84" DBA BRUSH030583
800S 84" MIL BRUSH056636

Jamb Weatherstripping

800S 96" MIL BRUSH061569
802S 36" DBA BRUSH054610
802S 36" GLD BRUSH054786
802S 36" MIL BRUSH053194
802S 36" x 84" MIL BRUSH051379
802S 48" DBA BRUSH061397
802S 48" GLD BRUSH067474
802S 48" MIL BRUSH054074
802S 48" x 84" MIL BRUSH051380
802S 72" MIL BRUSH055939
802S 84" BLA BRUSH016491
802S 84" DBA BRUSH	055941
802S 84" GLD BRUSH054500
802S 84" MIL BRUSH	052979
802S 96" DBA BRUSH054257
802S 96" MIL BRUSH	058708
803S 36" MIL BRUSH054075
803S 36" x 84" MIL BRUSH051382
803S 48" x 96" MIL BRUSH048945
803S 72" x 84" MIL BRUSH051394
803S 72" x 96" DBA BRUSH030527
803S 84" MIL BRUSH053077
808S 48" MIL BRUSH043629
808S 72" MIL BRUSH040087
808S 84" MIL BRUSH038341
859S 36" x 84" DBA031883
859S 36" x 84" MIL080290
859S 36" x 96" MIL030375
859S 36" x 108" MIL030376
859S 48" MIL067767
859S 48" x 84" MIL071926
859S 48" x 96" MIL042801
859S 72" DBA090769
859S 72" MIL095946
859S 72" x 84" MIL070969
859S 72" x 96" MIL091951
859S 84" DBA086427
859S 84" MIL028610
859S 96" MIL091966
860S 36" x 84" MIL NEOPRENE051234
860S 36" x 84" MIL VINYL091326
861S 36" MIL NEOPRENE065452
861S 36" x 84" MIL NEOPRENE051235
861S 72" x 84" MIL NEOPRENE051237
861S 84" MIL NEOPRENE065463
862S 36" CLR NEOPRENE083520

Jamb Weatherstripping

862S 36" x 84" CLR NEOPRENE083522
862S 48" CLR NEOPRENE060040
862S 48" x 84" CLR NEOPRENE084994
862S 72" x 84" CLR NEOPRENE083517
862S 72" x 84" DBA NEOPRENE058008
862S 72" x 96" CLR NEOPRENE083632
862S 72" x 96" DBA NEOPRENE055343
862S 84" CLR NEOPRENE083616
862S 84" DBA NEOPRENE073092
862S 96" DBA NEOPRENE061765
863S 36" x 84" CLR NEOPRENE058992
863S 48" x 84" CLR NEOPRENE092863
863S 72" x 84" CLR NEOPRENE087142
863S 84" CLR NEOPRENE084707
864S 36" CLR NEOPRENE083568
864S 36" x 84" CLR NEOPRENE057659
864S 36" x 96" CLR NEOPRENE083570
864S 36" x 108" CLR NEOPRENE062579
864S 48" x 84" CLR NEOPRENE086659
864S 48" x 96" CLR NEOPRENE032695
864S 72" x 84" CLR NEOPRENE083572
864S 72" x 84" DBA NEOPRENE065293
864S 84" CLR NEOPRENE083573
864S 96" CLR NEOPRENE094658
865S 36" DBA NEOPRENE073815
865S 36" GLD NEOPRENE055359
865S 36" MIL NEOPRENE087913
865S 36" x 84" DBA NEOPRENE036985
865S 36" x 84" GLD NEOPRENE091572
865S 36" x 84" MIL NEOPRENE062415
865S 36" x 96" DBA NEOPRENE096197
865S 36" x 96" MIL NEOPRENE017295
865S 36" x 108" MIL NEOPRENE083004
865S 48" MIL NEOPRENE102562
865S 48" x 84" MIL NEOPRENE028997
865S 48" x 96" DBA NEOPRENE125536
865S 48" x 96" MIL NEOPRENE075191
865S 48" x 108" MIL NEOPRENE092260
865S 72" MIL NEOPRENE087915
865S 72" x 84" DBA NEOPRENE081104
865S 72" x 84" MIL NEOPRENE022917
865S 72" x 96" MIL NEOPRENE037449
865S 84" MIL NEOPRENE025286
865S 96" GLD NEOPRENE083908
865S 96" MIL NEOPRENE054907
866S 36" MIL NEOPRENE055632

Jamb Weatherstripping

866S 36" x 84" DBA NEOPRENE040799
866S 36" x 84" MIL NEOPRENE056313
866S 36" x 96" MIL NEOPRENE031942
866S 48" MIL NEOPRENE006290
866S 48" x 84" MIL NEOPRENE037712
866S 48" x 108" MIL NEOPRENE089576
866S 72" MIL NEOPRENE055553
866S 72" x 84" DBA NEOPRENE092913
866S 72" x 84" MIL NEOPRENE007786
866S 72" x 96" MIL NEOPRENE103804
866S 84" MIL NEOPRENE042719
866S 96" DBA NEOPRENE031357
866S 96" MIL NEOPRENE055485
866S 120" MIL NEOPRENE074592
870S 36" x 84" US10B NEOPRENE020778
870S 36" x 84" CLR NEOPRENE	059054
870S 36" x 84" DBA NEOPRENE053497
870S 36" x 84" GLD NEOPRENE016082
870S 36" x 96" CLR NEOPRENE083619
870S 48" CLR NEOPRENE068708
870S 48" x 84" CLR NEOPRENE	063110
870S 48" x 96" CLR NEOPRENE091229
870S 72" CLR NEOPRENE083870
870S 72" x 84" CLR NEOPRENE	083596
870S 72" x 84" DBA NEOPRENE053881
870S 72" x 96" CLR NEOPRENE084596
870S 84" CLR NEOPRENE083597
870S 84" DBA NEOPRENE060876
870S 96" CLR NEOPRENE083884
871S 36" MIL NEOPRENE023335
871S 36" x 84" MIL NEOPRENE051255
871S 48" x 84" MIL NEOPRENE051198
871S 72" x 84" MIL NEOPRENE051257
871S 84" MIL NEOPRENE063621
873S 36" MIL NEOPRENE053862
873S 36" x 84" DBA NEOPRENE053712
873S 36" x 84" MIL NEOPRENE051263
873S 36" x 96" MIL NEOPRENE058799
873S 48" x 84" MIL NEOPRENE051264
873S 72" x 84" MIL NEOPRENE051265
873S 84" DBA NEOPRENE063162
873S 84" MIL NEOPRENE053864
874S 36" US32D NEOPRENE105906
874S 36" x 84" US32D NEOPRENE064413
874S 36" x 84" MIL NEOPRENE054083
874S 48" US32D NEOPRENE113653



Jamb Weatherstripping

874S 72" x 84" US32D NEOPRENE	102266
874S 72" x 96" US32D NEOPRENE	064095
874S 72" x 96" MIL NEOPRENE	087114
874S 84" MIL NEOPRENE	052592
874S 96" CLR NEOPRENE	130963
874S 96" MIL NEOPRENE	057221
874S 120" US32D NEOPRENE	078861
875S 36" CLR NEOPRENE	083401
875S 36" x 84" CLR NEOPRENE	058096
875S 36" x 108" CLR NEOPRENE	053915
875S 48" CLR NEOPRENE	083402
875S 48" x 84" CLR NEOPRENE	084882
875S 72" x 84" CLR NEOPRENE	059921
875S 84" CLR NEOPRENE	084251
875S 36" x 84" CLR SILICONE	003880
877S 36" x 84" MIL NEOPRENE	072544
878S 36" x 84" CLR NEOPRENE	058993
880S 36" x 84" MIL NEOPRENE	051275
880S 72" x 84" MIL NEOPRENE	051277
881S 36" MIL NEOPRENE	065849
881S 36" x 84" NEOPRENE	035415
881S 36" x 84" DBA NEOPRENE	084186
881S 36" x 84" MIL NEOPRENE	051279
881S 36" x 96" MIL NEOPRENE	087921
881S 48" MIL NEOPRENE	058998
881S 48" x 84" GLD NEOPRENE	058764
881S 48" x 84" MIL NEOPRENE	051280
881S 72" MIL NEOPRENE	068703
881S 72" x 84" DBA NEOPRENE	062108
881S 72" x 84" GLD NEOPRENE	034678
881S 72" x 84" MIL NEOPRENE	051281
881S 72" x 96" MIL NEOPRENE	087923
881S 84" MIL NEOPRENE	054328
881S 96" MIL NEOPRENE	087019
881S 36" MIL SILICONE	065435
881S 36" x 84" MIL SILICONE	055461
881S 36" x 96" MIL SILICONE	080370
881S 36" x 108" MIL SILICONE	049936
881S 48" MIL SILICONE	070160
881S 48" x 84" MIL SILICONE	075414
881S 48" x 96" MIL SILICONE	022364
881S 48" x 108" MIL SILICONE	056004
881S 72" MIL SILICONE	062770
881S 72" x 84" MIL SILICONE	062773
881S 72" x 96" MIL SILICONE	080371
881S 84" MIL SILICONE	054669

Jamb Weatherstripping

881S 96" MIL SILICONE	080374
881S 36" DBA VINYL	074308
881S 36" MIL VINYL	053349
881S 36" x 84" VINYL	000159
881S 36" x 84" DBA VINYL	058981
881S 36" x 84" MIL VINYL	052013
881S 36" x 96" MIL VINYL	078158
881S 36" x 108" MIL VINYL	072388
881S 48" MIL VINYL	055205
881S 48" x 84" MIL VINYL	052014
881S 48" x 96" MIL VINYL	073151
881S 72" MIL VINYL	053348
881S 72" x 84" DBA VINYL	058982
881S 72" x 84" MIL VINYL	056386
881S 72" x 96" DBA VINYL	058983
881S 72" x 96" MIL VINYL	063628
881S 84" MIL VINYL	055208
881S 96" MIL VINYL	062481
881S 36" MIL PILE	061446
881S 36" x 84" MIL PILE	065534
881S 36" x 96" MIL PILE	050803
881S 48" x 84" MIL PILE	079361
881S 48" x 96" MIL PILE	055447
881S 72" MIL PILE	073013
881S 72" x 84" MIL PILE	068518
882S 84" CLR BRUSH	092969
882S 84" DBA BRUSH	092972
882S 84" GLD BRUSH	092977
882S 96" CLR BRUSH	092971
882S 96" DBA BRUSH	092975
882S 96" GLD BRUSH	092978
883S 36" CLR BRUSH	092979
883S 36" DBA BRUSH	092980
883S 84" CLR BRUSH	022506
884S 36" CLR VINYL	092987
884S 36" x 84" GLD VINYL	145335
884S 48" CLR VINYL	092988
884S 84" VINYL	112086
884S 84" CLR VINYL	092989
884S 84" DBA VINYL	092992
884S 84" GLD VINYL	093003
884S 96" CLR VINYL	092990
884S 96" DBA VINYL	093002
884S 96" GLD VINYL	093004
885S 72" x 84 CLR NEOPRENE	095035
885S 84" NEOPRENE	062195

Jamb Weatherstripping

885S 84" CLR SILICONE098428
885S 36" x 84" CLR VINYL094826
885S 36" x 84" DBA VINYL064909
885S 72" x 84" DBA VINYL026261
885S 72" x 96" DBA VINYL098563
885S 84" CLR VINYL054716
885S 96" DBA PILE135972
890S 36" x 84" DBA NEOPRENE054834
890S 36" x 84" MIL NEOPRENE064142
890S 48" x 84" MIL NEOPRENE091396
890S 72" x 84" DBA NEOPRENE054835
890S 72" x 84" MIL NEOPRENE064143
890S 72" x 96" MIL NEOPRENE078079
890S 84" MIL NEOPRENE072200
890S 36" x 84" MIL SILICONE060628
890S 72" x 96" MIL SILICONE093708
890S 36" MIL VINYL065300
890S 36" x 84" DBA VINYL053199
890S 36" x 84" MIL VINYL051287
890S 48" MIL VINYL053842
890S 48" x 84" MIL VINYL051288
890S 72" MIL VINYL069373
890S 72" x 84" MIL VINYL051302
890S 72" x 96" MIL VINYL056203
890S 84" MIL VINYL053181
890S 96" MIL VINYL053841
891S 36" x 84" DBA NEOPRENE055108
891S 36" x 84" GLD NEOPRENE093250
891S 36" x 84" MIL NEOPRENE056722
891S 36" x 96" DBA NEOPRENE014000
891S 36" x 96" MIL NEOPRENE057549
891S 48" x 84" DBA NEOPRENE057018
891S 48" x 84" MIL NEOPRENE057511
891S 48" x 96" DBA NEOPRENE033393
891S 72" x 84" DBA NEOPRENE057019
891S 72" x 84" GLD NEOPRENE074600
891S 72" x 84" MIL NEOPRENE057020
891S 72" x 96" DBA NEOPRENE019682
891S 72" x 96" MIL NEOPRENE061748
891S 84" DBA NEOPRENE008359
891S 84" MIL NEOPRENE073792
891S 96" MIL NEOPRENE025113
891S 36" x 84" DBA SILICONE057068
891S 36" x 84" MIL SILICONE057519
891S 48" x 84" MIL SILICONE059552
891S 72" GASKET ONLY, SILICONE BLACK134581

Jamb Weatherstripping

891S 72" GASKET ONLY, SILICONE BLACK BKG134598
891S 72" x 84" MIL SILICONE061696
891S 72" x 96" MIL SILICONE081032
891S 84" GASKET ONLY, SILICONE BLACK BKG134783
891S 84" MIL SILICONE056283
891S 96" MIL SILICONE056284
891S 36" DBA VINYL003929
891S 36" MIL VINYL052986
891S 36" x 84" CLR VINYL033882
891S 36" x 84" DBA VINYL052356
891S 36" x 84" GLD VINYL052599
891S 36" x 84" MIL VINYL051304
891S 36" x 84" MIL VINYL TEK053838
891S 36" x 96" DBA VINYL054437
891S 36" x 96" MIL VINYL053667
891S 36" x 108" MIL VINYL057520
891S 48" MIL VINYL055375
891S 48" x 84" DBA VINYL052432
891S 48" x 84" GLD VINYL057871
891S 48" x 84" MIL VINYL051305
891S 48" x 96" DBA VINYL054216
891S 48" x 96" MIL VINYL056032
891S 72" MIL VINYL053692
891S 72" x 84" DBA VINYL052357
891S 72" x 84" GLD VINYL054126
891S 72" x 84" MIL VINYL051306
891S 72" x 96" DBA VINYL052433
891S 72" x 96" MIL VINYL052431
891S 84" DBA VINYL064207
891S 84" MIL VINYL053031
891S 96" DBA VINYL071086
891S 96" MIL VINYL053015
892S 36" x 84" DBA NEOPRENE044791
892S 36" x 84" GLD NEOPRENE047155
892S 36" x 84" MIL NEOPRENE044788
892S 48" x 84" MIL NEOPRENE044785
892S 72" x 84" DBA NEOPRENE048297
892S 72" x 84" GLD NEOPRENE071107
892S 72" x 84" MIL NEOPRENE044786
892S 84" MIL NEOPRENE044967
893S 36" DBA PILE055134
893S 36" MIL PILE051285
893S 36" x 84" MIL PILE051314
893S 72" x 84" MIL PILE051313
893S 84" CLR PILE085233
893S 84" DBA PILE058449



Jamb Weatherstripping

893S 84" GLD PILE064959
893S 84" MIL PILE053666
893S 96" MIL PILE056263
896S 36" x 84" DBA NEOPRENE036879
896S 36" x 84" MIL NEOPRENE033668
896S 48" x 84" MIL NEOPRENE037316
896S 48" x 96" MIL NEOPRENE050091
896S 72" x 84" MIL NEOPRENE035258
896S 84" MIL NEOPRENE035980
896S 96" MIL NEOPRENE049422
896S 36" x 84" MIL SILICONE066836
896S 48" x 84" MIL SILICONE051154
896S 36" MIL VINYL063497
896S 36" x 84" GLD VINYL087327
896S 36" x 84" MIL VINYL073543
896S 72" x 84" MIL VINYL074012
896S 84" MIL VINYL033779

Astragals

756S 84" DBA VINYL054120
756S 84" MIL VINYL059622
756S 96" DBA VINYL020114
756S 96" MIL VINYL075551
771S 84" MIL NEOPRENE097923
771S 96" MIL SILICONE123173
771S 84" MIL VINYL037527
771S 96" MIL VINYL046239
771S 84" MIL PILE052983
774S 96" MIL NEOPRENE059422
774S 84" MIL VINYL085136
802S 84" DBA BRUSH055941
802S 84" GLD BRUSH054500
802S 84" MIL BRUSH052979
802S 96" DBA BRUSH054257
802S 96" MIL BRUSH058708
835S 84" US32D057965
835S 84" DBA054076
835S 84" GLD052598
835S 84" GYP052218
835S 84" MIL051399
835S 96" US32D082492
835S 96" DBA054077
835S 96" GYP054078
835S 96" MIL051401
835S 120" US32D019549
835S 120" DBA028190
835S 120" GYP066347

Astragals

835S 120" MIL072577
836S 84" DBA052438
836S 84" GLD067594
836S 84" MIL051402
836S 96" DBA065451
836S 96" MIL051404
836S 120" DBA056267
836S 120" MIL070159
837S 84" DBA NEOPRENE058049
837S 84" GLD NEOPRENE060491
837S 84" MIL NEOPRENE051407
837S 96" DBA NEOPRENE052767
837S 96" MIL NEOPRENE051408
837S 120" MIL NEOPRENE069420
837S 84" DBA SILICONE058625
837S 84" GLD SILICONE062464
837S 84" MIL SILICONE056392
837S 96" DBA SILICONE058626
837S 96" GLD SILICONE079237
837S 96" MIL SILICONE058141
837S 84" DBA VINYL052439
837S 84" GLD VINYL054867
837S 84" MIL VINYL051405
837S 84" WHP VINYL076481
837S 96" DBA VINYL059436
837S 96" GLD VINYL090519
837S 96" MIL VINYL051406
837S 120" MIL VINYL059619
839SW 84" MIL BRUSH141943
839S 84" MIL BRUSH141944
839S 96" MIL BRUSH141947
839S 120" MIL BRUSH141949
845S 84" MIL PILE051409
846S 84" MIL051410
847S 84" DBA PILE075287
847S 84" GLD PILE000606
847S 96" GLD PILE135979
848S 84" DBA075288
848S 84" GLD128894
849S 84" DBA038794
849S 84" MIL014074
849S 96" DBA075587
849S 96" MIL031904
872S 84" CLR NEOPRENE053566
872S 84" DBA NEOPRENE052859
872S 84" GLD NEOPRENE053173

Astragals

872S 96" CLR NEOPRENE083594
872S 120" CLR NEOPRENE084691
874S 84" MIL NEOPRENE052592
874S 96" CLR NEOPRENE130963
874S 96" MIL NEOPRENE057221
874S 120" US32D NEOPRENE078861

Rain Drips

810S 40" AWP057538
810S 40" DBA052360
810S 40" GLD052597
810S 40" MIL051396
810S 52" MIL054095
810S 76" DBA052924
810S 76" GLD075081
810S 76" MIL051398





H **HAGER**[®]
COMPANIES

TABLE OF CONTENTS

B		9628 9629 9630 9631 Framed Kits21
Barn Door Hardware		9678 Packaged Sets.....22
9400 Series Barn Door Packaged Sets.....	38	9850 Framed Kits.....23
Barn Door Privacy Lock.....	42	9878 Packaged Sets24
eConestoga Series Barn Door Hardware.....	41	9901 Packaged Sets.....25
Bi-Fold Door Hardware		
9570 Packaged Sets.....	17	Q
9860 Packaged Sets and 9861 Packaged Sets ...	18	Quick Ship 2
9890 Packaged Sets and 9891 Packaged Sets ...	19	S
		Side Mount Selection Chart.....
	2
By-Pass Door Hardware		W
9110 Packaged Sets and 9130 Packaged Sets.	4	Wall Mount 9710 Series26
9514 Packaged Sets and 9583 Packaged Sets.	5	
9611 Packaged Sets and 9612 Packaged Sets.	7	
9614 Packaged Sets and 9683 Packaged Sets.	8	
9673 Packaged Sets and 9674 Packaged Sets ...	10	
9675 Packaged Sets and 9676 Packaged Sets ...	11	
9844 Packaged Sets and 9845 Packaged Sets ...	13	
9875 Packaged Sets.....	15	
9885 Packaged Sets and 9886 Packaged Sets ...	16	
C		
Components for 9400 Series Barn Door Hardware ...	39	
Components for Sliding Door Hardware	27-37	
D		
Door Selection Chart.....	3	
H		
How to Order.....	2	
L		
Lead Times.....	2	
P		
Pocket Door Hardware		
9110 Packaged Sets and 9130 Packaged Sets....	20	



Sliding Door Hardware

GENERAL INFORMATION

Lead Times

Stock items will typically ship in five working days or less from the order entry date. Made-to-order items will typically ship in 15 working days depending on seasonal volume and order complexity. Special orders including industrials, special machining, and large quantities may need to be scheduled. The anticipated ship date will be included with each order acknowledgement. Please contact Customer Service if product availability is in question.

Quick Ship

Products denoted with **red and bold** pricing are available to order through the Quick Ship program and ship within 24 hours. When ordering these products please visit www.hagerco.com and log in to MyHager to access the 'Quick Ship' portal. Due to the promptness of the fulfillment process, Quick Ship orders are non-cancellable.

Cancellation Notification

Cancellation for made-to-order items must be communicated within 48 hours of order placement.

HOW TO ORDER:

EXAMPLE: 9710 Wall Mount Packaged Set For 1 Door CLA 72"

STOCK NUMBER: 160958

ITEM NUMBER: 9710007200000CLA

Side Mount Selection Chart					
Door thickness	3/4" (19mm)	1" (25.4mm)	1-1/8" (29mm)	1-3/8" (35mm)	1-3/4" (44mm)
Front hanger	B	B	A or B	B	A
Rear hanger	A	A	Same as front	B	B
Door gap	3/4"	1/2"	1 1/16"	9/16"	3/8"
Item #	Description				
Hanger A	9200	Single wheel hanger-offset A			
Hanger B	9201	Single wheel hanger-offset B			
Hanger B	9202	Twin wheel hanger- offset B			

Hanger Mount Selection Example:

Door thickness: 1-1/8"

Door weight: 60 lbs.

Select single, twin or micro cam hanger

Front hanger: 9400

Rear hanger: 9400

Note: Hanger is stamped "A" or "B" for easy identification for consideration for 9514, 9583, 9614, 9683, 9844 and 9845 by-pass packaged sets located on pages 5, 7 and 10.



Sliding Door Hardware

Maximum Weight Per Door	Packaged Sets	Description	Parts Bags	Track	Page #
By-Pass					
60#	9514	Aluminum track & hardware for 3/4" - 1-3/8" thick doors.	9814	9810	5
60#	9583	Aluminum track & hardware for 3/4" - 1-3/8" thick doors, for 3 doors.	9814	9810	5
60#	9614	Aluminum track with grooved fascia - hardware for 1-3/8" thick doors.	9540	9820	8
60#	9683	Aluminum track with grooved fascia - hardware for 1-3/8" thick doors.	9401 hangers	9820	8
125#	9673	Heavy duty aluminum box track with grooved fascia & hardware for 1-3/8" - 1-3/4" thick doors.	9679	9603	10
125#	9675	Heavy duty aluminum box track & hardware for 1-3/8" & 1-3/4" thick doors.	9679	9602	11
150#	9611	Aluminum double box track & hardware for 1-3/8" & 1-3/4" thick doors.	9892	9821	7
150#	9674	Heavy duty aluminum box track with grooved fascia & hardware for 1-3/8" & 1-3/4" thick doors.	9680	9603	10
150#	9676	Heavy duty aluminum box track & hardware for 1-3/8" & 1-3/4" thick doors.	9680	9602	11
175#	9110	Heavy duty aluminum I-beam track and hardware for 1" - 1-3/4" thick doors. *Must order 2 per by pass.*	9109	9101	4
250#	9612	Aluminum double box track & hardware for 1-3/8" & 1-3/4" thick doors.	9893	9821	7
250#	9875	Heavy duty aluminum box track & hardware for 1-3/8" & 1-3/4" thick doors.	9827 hangers	9801	15
250#	9885	Heavy duty aluminum double track with smooth fascia & hardware for 1-3/8" & 1-3/4" thick doors.	9827 hangers	9803	16
250#	9886	Heavy duty aluminum double track with smooth fascia & hardware for 1-3/8" & 1-3/4" thick doors.	9827 hangers	9803	16
275#	9130	Heavy duty aluminum I-beam track and hardware for 1" thick doors and up. *Must order 2 per by pass.*	9129	9101	4
Bi-Fold Sets					
50#	9570	Aluminum track & hardware for 1-1/8" & 1-3/4" thick doors.	9571	9601	17
125#	9860	Heavy duty aluminum box track & hardware for 1-3/8" & 1-3/4" thick doors.	9894	9821	18
125#	9861	Heavy duty aluminum box track & hardware for 1-3/8" & 1-3/4" thick doors.	9894	9821	18
125#	9890	Heavy duty aluminum box track & hardware for for 1-1/8" & 1-3/4" thick doors. Up to 75 lbs per panel for multi fold applications.	9827 hangers	9801	19
125#	9891	"Heavy duty aluminum box track & hardware for 1-1/8" & 1-3/4" thick doors.	9827 hangers	9801	19
Pocket Door Sets					
125#	9678	Heavy duty aluminum box track & hardware for 1-3/8" & 1-3/4" thick doors.	9632	9601	22
150#	9678	Heavy duty aluminum box track & hardware for 1-3/8" & 1-3/4" thick doors.	9633	9101	22
175#	9110	Heavy duty aluminum I-beam track & hardware for 1" thick doors and up.	9109	9101	20
250#	9878	Aluminum box track & hardware for 1-3/8" thick doors and up.	9742	9801	22
250#	9901	Extra heavy duty aluminum box track & hardware for 1-3/8" & 1-3/4" thick doors.	9895	9821	20
275#	9130	Heavy duty aluminum I-beam track & hardware for 1" thick doors and up.	9129	9101	20
Pocket Door Frame Kits					
All Pocket Door Framed Kits for 1-3/8" Thick Doors					
75#	9631	Pocket Door Packaged Sets for 3'0" wide 6'8" high door	9606 hangers	9601	19
75#	9628	Pocket Door Packaged Sets for 3'0" wide 7'0" high door	9606 hangers	9601	21
75#	9629	Pocket Door Packaged Sets for 3'0" wide 8'0" high door	9606 hangers	9601	21
75#	9630	Pocket Door Packaged Sets for 3'0" wide 9'0" high door	9606 hangers	9601	21
250#	9850	Pocket Door Packaged Sets for 4'0" wide 8'0" high door	9827 hangers	9801	23
250#	9850	Pocket Door Packaged Sets for 4'0" wide 8'6" high door	9827 hangers	9801	23
Wall Mount Sets					
250#	9710	Heavy duty aluminum track & hardware for 1" & 1-3/4" thick doors.	9711	9703	26
Barn Door Pakaged Sets					
250#	All	9400 Series Stainless Steel Barn Door	N/A	N/A	42
250#	All	eConestoga Series Barn Door Hardware	N/A	N/A	44

Sliding Door Hardware - 9110 and 9130 Packaged Sets - By-Pass



Description	Finish	2021 List	Stock No.	Case Qty.
9110 Packaged Sets for doors up to 175 lbs (79 kg) per door.				
Contents: 9101 track, 9109 parts bag Heavy duty aluminum I-beam track & hardware for 1" - 1-3/4" (25mm - 45mm) thick doors.				
9110-60 - Packaged set for 2'6" door	60" (1524 mm)	121.10	135334	5
9110-72 - Packaged set for 3'0" door	72" (1829 mm)	133.85	135335	
9110-84 - Packaged set for 3'6" door	84" (2134 mm)	145.80	135336	
9110-96 - Packaged set for 4'0" door	96" (2438 mm)	158.70	135337	
9110-120 - Packaged set for 5'0" door	120" (3048 mm)	163.40	135338	
9110-144 - Packaged set for 6'0" door	144" (3658 mm)	191.35	135339	

Note: Must order 2 each 9110 packaged sets

9130 Packaged Sets for doors up to 275 lbs (125 kg) per door.

Contents: 9101 track, 9129 parts bag

9130-60 - Packaged set for 2'6" door	60" (1524 mm)	154.70	135340	5
9130-72 - Packaged set for 3'0" door	72" (1829 mm)	165.85	135341	
9130-84 - Packaged set for 3'6" door	84" (2134 mm)	167.50	135342	
9130-96 - Packaged set for 4'0" door	96" (2438 mm)	182.60	135343	
9130-120 - Packaged set for 5'0" door	120" (3048 mm)	216.10	135344	
9130-144 - Packaged set for 6'0" door	144" (3658 mm)	241.15	135346	

Note: Must order 2 each 9130 packaged sets



9101-60 - I-beam track only, heavy duty aluminum	60" (1524 mm)	AL	56.50	023278	5
9101-72 - I-beam track only, heavy duty aluminum	72" (1829 mm)	AL	70.75	096508	
9101-84 - I-beam track only, heavy duty aluminum	84" (2134 mm)	AL	84.30	096509	
9101-96 - I-beam track only, heavy duty aluminum	96" (2438 mm)	AL	90.10	096707	
9101-120 - I-beam track only, heavy duty aluminum	120" (3048 mm)	AL	117.85	096511	
9101-144 - I-beam track only, heavy duty aluminum	144" (3658 mm)	AL	141.80	096512	
9101-192 - I-beam track only, heavy duty aluminum	192" (4877 mm)	AL	188.25	096513	

Parts Description

9109 - 2 ea. 9102 two wheel hangers, 1 ea. 9115 floor guide. <i>*Up to 175 lbs (79 kg) per door.*</i>		58.70	135690	10
9129 - 2 ea. 9105 four wheel hangers, 1 ea. 9115 floor guide. <i>*Up to 275 lbs (125 kg) per door.*</i>		86.60	135315	10

Components Description

9102 2 Wheel Hanger - For use with 9101 track	US2C	25.75	135310	20
9105 4 Wheel Hanger - For use with 9101 track	US2C	38.65	135312	40
9115 Bottom Door Guide	US2C	9.15	096522	50



Sliding Door Hardware - 9514 and 9583 Packaged Sets - By-Pass



Description	Finish	2021 List	Stock No.	Case Qty.
9514 Packaged Sets for doors up to 60 lbs (27 kg) each for two (2) doors.				
Contents: 9810 track, 9814 parts bag. Refer to side mount selection chart for combination of hangers. Aluminum track & hardware For 3/4" (19 mm) and 1-3/8" (35mm) thick doors.				
9514-48 - By-pass set for two 24" doors	48" (1219 mm)	38.65	099662	5
9514-60 - By-pass set for two 30" doors	60" (1524 mm)	41.85	099663	
9514-72 - By-pass set for two 36" doors	72" (1829 mm)	46.60	099666	
9514-96 - By-pass set for two 48" doors	96" (2438 mm)	61.90	017418	
9583 Packaged Sets for doors up to 60 lbs (27 kg) each for three (32") doors.				
Contents: 9810 track, 2 ea. 9400 hangers, 4 ea. 9401 hangers, 2 ea. 9353 guides, 3 ea. 2610 pulls				
9583-96 -	96" (2438 mm)	70.75	029415	5
9810-46 - Aluminum track	46-3/8" (1178 mm)	AL 16.30	019702	10
9810-58 - Aluminum track	58-3/8" (1483 mm)	AL 19.45	019703	
9810-70 - Aluminum track	70-3/8" (1788 mm)	AL 23.60	019704	
9810-93 - Aluminum track	93-3/8# (2372 mm)	AL 30.55	019705	
9810-120 - Aluminum track	120" (3048 mm)	AL 38.65	016570	
9810-144 - Aluminum track	144" (3658 mm)	AL 51.40	026064	
Parts Description				
9814 - 2 ea. 9400 hangers, 2 ea. 9401 hangers, 2 ea. 2610 pulls, 1 ea. 9353 guide		15.40	016772	10
9841 - For 1" to 1-1/8", specify 9841 parts bag. 4 ea. 9401 hangers, 2 ea. 9865 pulls, 1 ea. 9351 guide		8.35	099665	10
Components Description				
2610				
Finger Pull	US3	1.00	013049	500
	US4	1.00	071953	
Material: Brass	US5	1.00	067282	
Overall Diameter: 31/32"	US10A	1.00	068711	
Finger Pull Diameter: 3/4"	US15	1.00	040589	
Pull Clearance: 5/16"	US15A	1.00	040590	
Projection: 1/32"	US26	1.00	013047	
	US26D	1.00	071169	
9351		2.75	096563	50
Door Guide				
9353		2.75	096564	20
Adjustable Door Guide				
9400	US2C	3.45	017417	100
Cam Adjustable Hanger - Small 3/8" (10 mm) offset A				
9401	US2C	3.45	096566	100
Cam Adjustable Hanger - Large 11/16" (18 mm) offset B				

1. For additional components, refer to component section. 2. Items with the price in **bold and red** are Quick Ship items and ship in 24 hours. Please use stock number when ordering. 3. U/M is each unless otherwise noted. 4. Packaged sets and parts bags are available with optional components by special quotation.



Sliding Door Hardware - 9865 Packaged Sets - By-Pass



Description	Finish	2021 List	Stock No.	Case Qty.
9865 Plastic Pull Overall Diameter: 1-31/32" Finger Pull Diameter: 1-19/32" Pull Clearance: 1 1/32" Projection: 5/64"	Plastic	1.05	098993	50



Sliding Door Hardware - 9611 and 9612 Packaged Sets - By-Pass



Description	Finish	2021 List	Stock No.	Case Qty.
9611 Packaged Sets for doors up to 150 lbs (68 kg) each.				
9573 spacer kit is used for 1-3/4" (4 mm) doors. No spacer kit required for 1-3/8" (35 mm) doors. Contents: 2 ea. 9821 tracks, 9892 parts bag For 1-3/8" (35 mm) and 1-3/4" (44 mm) thick doors.				
9611-60 - By-pass set for two 30" doors	60" (1524 mm)	130.70	019404	5
9611-72 - By-pass set for two 36" doors	72" (1829 mm)	140.50	019402	
9611-96 - By-pass set for two 48" doors	96" (2438 mm)	169.95	019389	
9612 Packaged Sets for doors up to 250 lbs (113 kg) each.				
Contents: 2 pcs 9821 Track, 9893 Parts bag				
9612-60 - By-pass set for two 30" doors	60" (1524 mm)	164.25	019368	5
9612-72 - By-pass set for two 36" doors	72" (1829 mm)	175.60	019362	
9612-96 - By-pass set for two 48" doors	96" (2438 mm)	191.20	019378	
9821-59 - Aluminum box track	59" (1499 mm)	AL 31.85	019084	10
9821-71 - Aluminum box track	71" (1803 mm)	AL 39.45	019062	
9821-96 - Aluminum box track	96" (2438 mm)	AL 52.60	019061	
9821-144 - Aluminum box track	144" (3658 mm)	AL 76.20	019050	
Grooved fascia for painting				
9709-48 - Aluminum grooved fascia, 2-3/4" (70 mm) wide	48" (1219 mm)	AL 35.45	023321	10
9709-60 - Aluminum grooved fascia, 2-3/4" (70 mm) wide	60" (1524 mm)	AL 53.10	023322	
9709-72 - Aluminum grooved fascia, 2-3/4" (70 mm) wide	72" (1829 mm)	AL 60.95	096603	
9709-96 - Aluminum grooved fascia, 2-3/4" (70 mm) wide	96" (2438 mm)	AL 69.05	096604	
Parts Description				
9892 - 4 ea. 9824 four-wheel hangers w/ top mount plate, 1 ea. 9909 guide, 9573 spacer kit		54.30	019421	10
9893 - 4 ea. 9825 four-wheel ball bearing hangers w/ top mount plate, 1 ea. 9909 guide, 9573 spacer kit		101.60	019418	10
Components Description				
9573 Spacer Kit - 3/8" use with 9821 track - For doors 1-3/4" thick		5.10	019014	5
9824 4 Wheel Hanger w/ Top Mount Plate		28.65	135320	20
9825 4 Wheel Ball Bearing Hanger w/ Top Mount Plate		36.00	135321	10
9909 Heavy Duty Adjustable Door Guide From 3/4" to 1-3/4" (19 mm to 44 mm)	US2C	8.35	097528	20

1. For additional components, refer to component section. 2. Items with the price in **bold and red** are Quick Ship items and ship in 24 hours. Please use stock number when ordering. 3. U/M is each unless otherwise noted. 4. Packaged sets and parts bags are available with optional components by special quotation.



Sliding Door Hardware - 9614 and 9683 Packaged Sets - By-Pass



Components Description	Finish	2021 List	Stock No.	Case Qty.	
9614 Packaged Sets for doors up to 60 lbs (27 kg).					
Contents: 9820 track, 9540 parts bag. Refer to side mount selection chart on page 2 for combination of hangers.					
Aluminum track & hardware with 1-3/4" (44 mm) grooved fascia. For 1-3/8" (35 mm) thick doors.					
9614-48 - By-pass set for two 24" doors	48" (1219 mm)	48.30	099091	5	
9614-60 - By-pass set for two 30" doors	60" (1524 mm)	54.70	099756		
9614-72 - By-pass set for two 36" doors	72" (1829 mm)	62.60	016652		
9683 Packaged Sets for three (3) 32" doors and doors up to 60 lbs. (27 kg) each.					
Contents: 9820 track, 6 ea. 9401 hangers, 2 ea. 9351 guides, and 3 ea. 2610 pulls					
9683-96 - By-pass set for three 32" doors	96" (2438 mm)	88.30	022329		
Grooved fascia for painting					
9820-48 - Aluminum track with 1-3/4" grooved fascia	48" (1219 mm)	AL	29.95	000461	5
9820-60 - Aluminum track with 1-3/4" grooved fascia	60" (1524 mm)	AL	37.15	000462	
9820-72 - Aluminum track with 1-3/4" grooved fascia	72" (1829 mm)	AL	43.45	000463	
9820-84 - Aluminum track with 1-3/4" grooved fascia	84" (2134 mm)	AL	58.70	028175	
9820-96 - Aluminum track with 1-3/4" grooved fascia	96" (2438 mm)	AL	64.20	099664	
9820-120 - Aluminum track with 1-3/4" grooved fascia	120" (3048 mm)	AL	73.95	000464	
9820-144 - Aluminum track with 1-3/4" grooved fascia	144" (3658 mm)	AL	96.30	000460	
Parts Description					
9540 - 4 ea. 9401 hangers, 2 ea. 2610 pull, 1 ea. 9351 guide		9.85	017419	10	
9544 - 4 ea. 9202 hangers, 2 ea. 2630 pull, 1 ea. 9351 guide <i>*Used to increase door weight capacity to 75 lbs*</i>		14.60	017035		
9841 - 4 ea. 9401 hangers, 2 ea. 9865 pull, 1 ea. 9351 guide		8.35	099665		
9842 - 4 ea. 9401 hangers, 2 ea. 2630 pull, 1 ea., 9351 guide		11.45	017424		
9843 - 4 ea. 9202 hangers, 2 ea. 9865 pull, 1 ea. 9351 guide <i>*Used to increase door weight capacity to 75 lbs*</i>		13.05	016912		
Components Description					
2610	US3	1.00	013049	500	
Finger Pull	US4	1.00	071953		
Material: Brass	US5	1.00	067282		
Overall Diameter: 31/32"	US10A	1.00	068711		
Finger Pull Diameter: 3/4"	US15	1.00	040589		
Pull Clearance: 5/16"	US15A	1.00	040590		
Projection: 1/32"	US26	1.00	013047		
	US26D	1.00	071169		
2630	US3	4.30	051919	50	
Round Flush Pull	US4	4.30	073783		
Material: Brass	US5	4.30	053163		
Overall Diameter: 2-7/16"	US10A	4.30	073053		
Finger Pull Diameter: 2-1/16"	US15	4.30	073056		
Pull Clearance: 11/32"	US15A	4.30	005307		
Projection: 3/32"	US26	4.30	023430		
	US26D	4.30	023431		



1. For additional components, refer to component section. 2. Items with the price in **bold and red** are Quick Ship items and ship in 24 hours. Please use stock number when ordering. 3. U/M is each unless otherwise noted. 4. Packaged sets and parts bags are available with optional components by special quotation.



Sliding Door Hardware - 9614 and 9683 Packages Sets - By-Pass



Description	Finish	2021 List	Stock No.	Case Qty.
9202 Twin Wheel Hanger - Large 1 1/16" (18 mm) offset B	US2C	3.45	096562	100
9351 Door Guide		2.75	096563	50
9400 Cam Adjustable Hanger - Small 3/8" (10 mm) offset A	US2C	3.45	017417	100
9401 Cam Adjustable Hanger - Large 1 1/16" (18 mm) offset B	US2C	3.45	096566	100
9865 Plastic Pull Overall Diameter: 1-31/32" Finger Pull Diameter: 1-19/32" Pull Clearance: 11/32" Projection: 5/64"	Plastic	1.05	098993	50

1. For additional components, refer to component section. 2. Items with the price in **bold and red** are Quick Ship items and ship in 24 hours. Please use stock number when ordering. 3. U/M is each unless otherwise noted. 4. Packaged sets and parts bags are available with optional components by special quotation.



Sliding Door Hardware - 9673 and 9674 Packaged Sets - By-Pass

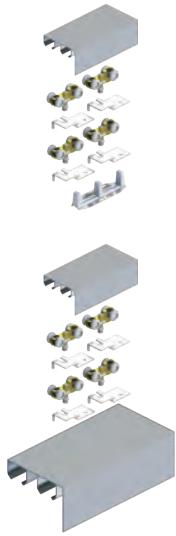

Description	Finish	2021 List	Stock No.	Case Qty.	
9673 Packaged Sets for doors up to 125 lbs (57 kg).					
Contents: 9603 track, 9679 parts bag					
Heavy duty aluminum double box track & hardware with 2-5/8" (66 mm) grooved fascia. For 1-3/8" (35 mm) and 1-3/4" (44 mm) thick doors.					
9673-48 - By-pass set for two 24" doors	48" (1219 mm)	139.50	137170	5	
9673-60 - By-pass set for two 30" doors	60" (1524 mm)	150.60	137171		
9673-72 - By-pass set for two 36" doors	72" (1829 mm)	159.40	137172		
9673-96 - By-pass set for two 48" doors	96" (2438 mm)	195.50	137173		
9674 Packaged Sets for doors up to 150 lbs (68 kg).					
9674-48 - By-pass set for two 24" doors	48" (1219 mm)	182.60	136345	5	
9674-60 - By-pass set for two 30" doors	60" (1524 mm)	193.05	136346		
9674-72 - By-pass set for two 36" doors	72" (1829 mm)	208.25	136347		
9674-96 - By-pass set for two 48" doors	96" (2438 mm)	241.15	136349		
Grooved fascia for painting.					
Double box track w/ built in grooved fascia.					
9603-48 - Aluminum box track with grooved fascia	48" (1219 mm)	AL	62.60	135288	5
9603-60 - Aluminum box track with grooved fascia	60" (1524 mm)	AL	75.45	135289	
9603-72 - Aluminum box track with grooved fascia	72" (1829 mm)	AL	89.85	135290	
9603-96 - Aluminum box track with grooved fascia	96" (2438 mm)	AL	117.15	135291	
9603-120 - Aluminum box track with grooved fascia	120" (3048 mm)	AL	146.70	029359	
9603-144 - Aluminum box track with grooved fascia	144" (3658 mm)	AL	180.35	029360	
Parts Description					
9575 - 4 ea. 9572 hangers w/ top mount plate, 1 ea. 9909 guide		28.30	137167	5	
9679 - 4 ea. 9605 hangers w/ top mount plate, 1 ea. 9909 guide		39.45	096600		
9680 - 4 ea. 9606 ball bearing hangers w/ top mount plate, 1 ea. 9909 guide		93.05	136357		
Components Description					
9572	4 Wheel Hanger w/ Top Mount Plate	US2D	12.25	135316	20
9605	4 Wheel Hanger w/ Top Mount Plate	US2D	5.75	135317	20
9606	4 Wheel Ball Bearing Hanger w/ Top Mount Plate	US2D	17.85	135318	20
9909	Heavy Duty Adjustable Door Guide From 3/4" to 1-3/4" (19 mm to 44 mm)	US2C	8.35	097528	20



1. For additional components, refer to component section. 2. Items with the price in **bold and red** are Quick Ship items and ship in 24 hours. Please use stock number when ordering. 3. U/M is each unless otherwise noted. 4. Packaged sets and parts bags are available with optional components by special quotation.



Sliding Door Hardware - 9675 and 9676 Packaged Sets - By-Pass



Description	Finish	2021 List	Stock No.	Case Qty.	
9675 Packaged Sets for doors up to 125 lbs (57 kg) each.					
Contents: 9602 track, 9679 parts bag Heavy duty aluminum double box track & hardware For 1-3/8" (35 mm) and 1-3/4" (44 mm) thick doors.					
9675-48 - By-pass set for two 24" doors	48" (1219 mm)	91.50	137175	5	
9675-60 - By-pass set for two 30" doors	60" (1524 mm)	97.85	137176		
9675-72 - By-pass set for two 36" doors	72" (1829 mm)	107.45	137177		
9675-96 - By-pass set for two 48" doors	96" (2438 mm)	126.70	137178		
9676 Packaged Sets for doors up to 150 lbs (68 kg) each.					
9676-48 - By-pass set for two 24" doors	48" (1219 mm)	139.50	136350	5	
9676-60 - By-pass set for two 30" doors	60" (1524 mm)	141.05	136351		
9676-72 - By-pass set for two 36" doors	72" (1829 mm)	155.50	136352		
9676-96 - By-pass set for two 48" doors	96" (2438 mm)	172.30	136353		
Grooved fascia for painting					
9709-48 - Aluminum grooved fascia, 2-3/4" (70 mm) wide	48" (1219 mm)	AL	35.45	023321	10
9709-60 - Aluminum grooved fascia, 2-3/4" (70 mm) wide	60" (1524 mm)	AL	53.10	023322	
9709-72 - Aluminum grooved fascia, 2-3/4" (70 mm) wide	72" (1829 mm)	AL	60.95	096603	
9709-96 - Aluminum grooved fascia, 2-3/4" (70 mm) wide	96" (2438 mm)	AL	69.05	096604	
9602-46 - Double box track only, heavy duty aluminum	46" (1168 mm)	AL	33.90	096582	5
9602-58 - Double box track only, heavy duty aluminum	58" (1473 mm)	AL	41.85	096583	
9602-70 - Double box track only, heavy duty aluminum	70" (1778 mm)	AL	48.30	096584	
9602-94 - Double box track only, heavy duty aluminum	94" (2388 mm)	AL	62.60	096585	
9602-118 - Double box track only, heavy duty aluminum	118" (2997 mm)	AL	75.45	096586	
9602-142 - Double box track only, heavy duty aluminum	142" (3607 mm)	AL	89.85	096587	
Parts Description					
9575 - 4 ea. 9572 hangers w/ top mount plate, 1 ea. 9909 guide		28.30	137167	5	
9679 - 4 ea. 9605 hangers w/ top mount plate, 1ea. 9909 guide		39.45	137179	5	
9680 - 4 ea. 9606 ball bearing hangers w/ top mount plate, 1ea. 9909 guide		93.05	136357	5	
Components Description					
9572 - 4 Wheel Hanger w/ Top Mount Plate	US2D	12.25	135316	20	
9605 - 4 Wheel Hanger w/ Top Mount Plate	US2D	5.75	135317	20	

1. For additional components, refer to component section. 2. Items with the price in **bold and red** are Quick Ship items and ship in 24 hours. Please use stock number when ordering. 3. U/M is each unless otherwise noted. 4. Packaged sets and parts bags are available with optional components by special quotation.



Sliding Door Hardware - 9675 and 9676 Packaged Sets - By-Pass



Components Description	Finish	2021 List	Stock No.	Case Qty.
9606 - 4 Wheel Ball Bearing Hanger w/ Top Mount Plate	US2D	17.85	135318	20
9909 - Heavy Duty Adjustable Door Guide From 3/4" to 1-3/4" (19 mm to 44 mm)	US2C	8.35	097528	20



Sliding Door Hardware - 9844 and 9845 Packaged Sets- By-Pass



Description	Finish	2021 List	Stock No.	Case Qty.
9844 Packaged Sets for doors up to 60 lbs (27 kg).				
Contents: 9840 track and 9540 parts bag. Refer to side mount selection chart on page 2 for combination of hangers.				
Galvanized steel track & hardware For 1-1/8" (29 mm) and 1-3/8" (35 mm) thick doors, use 9844 pkg set. For doors 3/4" (19 mm), 1" (25 mm), and 1-3/4" (44 mm) thick, use track 9840.				
9844-48 - By-pass set for two 24" doors	48" (1219 mm)	30.55	096652	5
9844-60 - By-pass set for two 30" doors	60" (1524 mm)	33.90	096653	

9845 Packaged Sets for three (3) doors and doors up to 60 lbs. (27 kg) per door.				
Contents: 9840 track, 2 ea. 9400 hangers, 4 ea. 9401 hangers, 2 ea. 9353 guides, and 3 ea. 2610 pulls				
9845-96 - By-pass set for three 32" doors	96" (2438 mm)	54.70	096668	5

Parts Description				
9540 - 4 ea. 9401 hangers, 2 ea. 2610 pulls, 1 ea., 9351 guide		9.85	017419	10
9544 - 4 ea. 9202 hangers, 2 ea. 2630 pulls, 1 ea., 9351 guide <i>*Used to increase door weight capacity to 75 pounds*</i>		14.60	017035	
9841 - 4 ea. 9401 hangers, 2 ea. 9865 pulls, 1 ea., 9351 guide		8.35	099665	
9842 - 4 ea. 9401 hangers, 2 ea. 2630 pulls, 1 ea., 9351 guide		11.45	017424	
9843 - 4 ea. 9202 hangers, 2 ea. 9865 pulls, 1 ea., 9351 guide <i>*Used to increase door weight capacity to 75 pounds*</i>		13.05	016912	

Components Description				
2610	US3	1.00	013049	500
Finger Pull	US4	1.00	071953	
Material: Brass	US5	1.00	067282	
Overall Diameter: 31/32"	US10A	1.00	068711	
Finger Pull Diameter: 3/4"	US15	1.00	040589	
Pull Clearance: 5/16"	US15A	1.00	040590	
Projection: 1/32"	US26	1.00	013047	
	US26D	1.00	071169	
2630	US3	4.30	051919	50
Round Flush Pull	US4	4.30	073783	
Material: Brass	US5	4.30	053163	
Overall Diameter: 2-7/16"	US10A	4.30	073053	
Finger Pull Diameter: 2-1/16"	US15	4.30	073056	
Pull Clearance: 11/32"	US15A	4.30	005307	
Projection: 3/32"	US26	4.30	023430	
	US26D	4.30	023431	
9202	US2C	3.45	096562	100
Twin Wheel Hanger - Large 11/16" (18 mm) offset B				
9351		2.75	096563	50
Door Guide				
9400	US2C	3.45	017417	100
Cam Adjustable Hanger - Small 3/8" (10 mm) offset A				
9401	US2C	3.45	096566	100
Cam Adjustable Hanger - Large 11/16" (18 mm) offset B				



1. For additional components, refer to component section. 2. Items with the price in **bold and red** are Quick Ship items and ship in 24 hours. Please use stock number when ordering. 3. U/M is each unless otherwise noted. 4. Packaged sets and parts bags are available with optional components by special quotation.



Sliding Door Hardware - 9844 and 9845 Packaged Sets - By-Pass



Description	Finish	2021 List	Stock No.	Case Qty.
9865 Plastic Pull Overall Diameter: 1-31/32", Finger Pull Diameter: 1-19/32", Pull Clearance: 1 1/32", Projection: 5/64"	Plastic	1.05	098993	50

Sliding Door Hardware - 9875 Packaged Sets - By-Pass



Description	Finish	2021 List	Stock No.	Case Qty.	
9875 Packaged Sets for doors up to 250 lbs (113 kg).					
Contents: 2 ea. 9801 tracks, 4 ea. 9827 hangers w/ top mount plate, 1 ea. 9574 spacer, 1 ea. 9909 guide Heavy duty Aluminum box track & hardware For 1-3/8" (35 mm) and 1-3/4" (44 mm) thick doors. 9574 spacer kit is used for 1-3/4" (4 mm) doors. No spacer kit required for 1-3/8" (35 mm) doors.					
9875-48 - By-pass set for two 24" doors	48" (1219 mm)	189.15	137420	6	
9875-60 - By-pass set for two 30" doors	60" (1524 mm)	238.70	137421		
9875-72 - By-pass set for two 36" doors	72" (1829 mm)	251.45	137422		
9875-96 - By-pass set for two 48" doors	96" (2438 mm)	281.85	137423		
Grooved fascia for painting					
9809-72 - Aluminum grooved fascia, 3-7/8" (98 mm) thick	72" (1829 mm)	AL	95.45	096646	10
9809-96 - Aluminum grooved fascia, 3-7/8" (98 mm) thick	96" (2438 mm)	AL	125.00	096647	
9801-72 - Aluminum box track	72" (1829 mm)	AL	51.40	096641	10
9801-96 - Aluminum box track	96" (2438 mm)	AL	69.05	096642	
9801-120 - Aluminum box track	120" (3048 mm)	AL	86.60	096643	
9801-144 - Aluminum box track	144" (3658 mm)	AL	113.05	096644	
9801-192 - Aluminum box track	192" (4877 mm)	AL	150.60	096645	
Components Description					
9574		5.10	015991	5	
Spacer Kit - For use with 9801 - For doors 1-3/8" and 1-3/4" thick					
9827		41.85	018292	10	
4 Wheel Ball bearing Hanger w/ Top Mount Plate					
9909	US2C	8.35	097528	20	
Heavy Duty Adjustable Door Guide From 3/4" to 1-3/4" (19 mm to 44 mm)					

1. For additional components, refer to component section. 2. Items with the price in **bold and red** are Quick Ship items and ship in 24 hours. Please use stock number when ordering. 3. U/M is each unless otherwise noted. 4. Packaged sets and parts bags are available with optional components by special quotation.



Sliding Door Hardware - 9885 and 9886 Packaged Sets - Bi-Fold



Description	Finish	2021 List	Stock No.	Case Qty.
9885 Packaged Sets for two (2) doors up to 250 lbs (113 kg) each.				
Contents: 9803 track, 4 ea. 9827 hangers w/ top mount plate, 1 ea. 9909 guide, 1 ea. 9815 center stop for 9886 only.				
Heavy duty aluminum double box track with 3-1/2" (89 mm) smooth fascia & hardware, for two doors. For 1-3/8" (35 mm) and 1-3/4" (44 mm) thick doors.				
9885-48 - By-pass set for two 24" doors	48" (1219 mm)	215.55	137463	1
9885-60 - By-pass set for two 30" doors	60" (1524 mm)	241.85	137464	
9885-72 - By-pass set for two 36" doors	72" (1829 mm)	269.15	137465	
9885-96 - By-pass set for two 48" doors	96" (2438 mm)	306.50	137470	
9886 Packaged Sets for four (4) 24" doors up to 250 lbs. (113 kg) each.				
Contents: 9803 track, 8 ea. 9827 hangers w/ top mount plate, 2 ea. 9815 center stops, 2 ea. 9909 adjustable door guides.				
9886-96 - By-pass set for four 24" doors	96" (2438 mm)	437.00	137471	1



Components Description				
9815 Bumper Stop		7.35	096648	20
9827 4 Wheel Ball bearing Hanger w/ Top Mount Plate		41.85	018292	10
9909 Heavy Duty Adjustable Door Guide From 3/4" to 1-3/4" (19 mm to 44 mm)	US2C	8.35	097528	20

1. For additional components, refer to component section. 2. Items with the price in **bold and red** are Quick Ship items and ship in 24 hours. Please use stock number when ordering. 3. U/M is each unless otherwise noted. 4. Packaged sets and parts bags are available with optional components by special quotation.

Sliding Door Hardware - 9570 Packaged Sets - Bi-Fold



Description	Finish	2021 List	Stock No.	Case Qty.	
9570 Packaged Sets for doors up to 50 lbs (23 kg) bi-fold, 30 lbs per multi fold.					
Contents for 2 door set: 9601 Track, 9569 parts bag.					
Aluminum box track & hardware for 1" (25 mm) - 1-3/4" (44 mm) thick doors.					
9570-36 - Bi-fold set for two 18" doors	36" (914 mm)	AL	54.70	137161	6
9570-48 - Bi-fold set for four 12" doors	48" (1219 mm)	AL	80.30	137162	
9570-60 - Bi-fold set for four 15" doors	60" (1524 mm)	AL	86.60	137163	
9570-72 - Bi-fold set for four 18" doors	72" (1829 mm)	AL	93.05	137164	
9570-96 - Bi-fold set for four 24" doors	96" (2438 mm)	AL	105.10	137165	
9601-47 - Aluminum box track	47" (1194 mm)	AL	17.85	096576	10
9601-59 - Aluminum box track	59" (1499 mm)	AL	23.05	096577	
9601-71 - Aluminum box track	71" (1803 mm)	AL	25.10	096578	
9601-96 - Aluminum box track	96" (2438 mm)	AL	38.90	096579	
9601-120 - Aluminum box track	120" (3048 mm)	AL	43.45	096580	
9601-144 - Aluminum box track	144" (3658 mm)	AL	51.40	096581	

Parts Description	2021 List	Stock No.	Case Qty.
9569 - 1 ea. 9572 hanger w/ top mount plate, 9618 pivot set, 9559 aligner, 9558 knob and 9815 bumper stop, 3 ea. 9220 hinges	24.25	016913	10

Components Description	Finish	2021 List	Stock No.	Case Qty.
9220 Non-Mortise Bi-Fold Hinge with Screws	US2D	1.90	099119	600
9558 Wood Knob Knob Diameter: 1-1/2" Base Diameter: 15/16" Fasteners: #8 x 1-3/4" PPHWS	Wood	1.90	096567	100
9559 Aligner	US2D	1.05	096568	200
9572 4 Wheel Hanger w/ Top Mount Plate	US2D	12.25	135316	20
9815 Bumper Stop		7.35	096648	20
9618 Pivot Set - For 9570 series	-	8.35	137182	10



1. For additional components, refer to component section. 2. Items with the price in **bold and red** are Quick Ship items and ship in 24 hours. Please use stock number when ordering. 3. U/M is each unless otherwise noted. 4. Packaged sets and parts bags are available with optional components by special quotation.



Sliding Door Hardware - 9860 and 9861 Packaged Sets - Pocket Door



Description	Finish	2021 List	Stock No.	Case Qty.	
9860 Packaged Sets for doors up to 125 lbs (57 kg) per panel bi-fold.					
Contents: 9821 track, 1 ea. 9894 parts bag, and 3 ea. 1741 hinges Heavy duty Aluminum box track & hardware. For 1-3/8" (35mm) and 1-3/4" (44mm) thick doors.					
9860-30 - Bi-fold set for two 15" doors	30" (762 mm)	102.45	019456	6	
9860-36 - Bi-fold set for two 18" doors	36" (914 mm)	110.40	019452		
9860-48 - Bi-fold set for two 24" doors	48" (1219 mm)	123.35	019451		
9861 Packaged Sets for doors up to 125 lbs. (57 kg) per panel for multi-fold.					
Contents: 9821 track, 2 ea. 9894 parts bag, and 6 ea. 1741 hinges					
9861-48 - Bi-fold set for four 12" doors	48" (1219 mm)	196.85	019446	6	
9861-60 - Bi-fold set for four 15" doors	60" (1524 mm)	204.05	019439		
9861-72 - Bi-fold set for four 18" doors	72" (1829 mm)	218.25	019438		
9861-96 - Bi-fold set for four 24" doors	96" (2438 mm)	239.35	019437		
9821-59 - Aluminum box track	59" (1499 mm)	AL	31.85	019084	10
9821-71 - Aluminum box track	71" (1803 mm)	AL	39.45	019062	
9821-96 - Aluminum box track	96" (2438 mm)	AL	52.60	019061	
9821-144 - Aluminum box track	144" (3658 mm)	AL	76.20	019050	
Parts Description					
9894 - 1 ea. 9825 hanger w/ top mount plate, 9828 bi-fold pivot, 9815 bumper stop, 9559 aligner		90.65	019435	10	
Components Description					
1741 Full Mortise Plain Bearing Hinges with Screws 3-1/2" x 3-1/2"	US2D	2.00	029658	50	
9559 Aligner	US2D	1.05	096568	200	
9815 Bumper Stop		7.35	096648	20	
9825 Ball Bearing Hanger w/ Top Mount Plate		36.00	135321	10	
9828 Heavy Duty Pivot Set with 9815 Bumper Stop		52.05	018286	10	



Sliding Door Hardware - 9890 and 9891 Packaged Sets - Bi-Fold



Description	Finish	2021 List	Stock No.	Case Qty.
9890 Packaged Sets for doors up to 125 lbs (57 kg).				
Contents: 9801 track, 9827 hangers w/ top mount plate, 9828 pivots & 1741 hinges (3 ea. for 2 doors, 6 ea. for 4 doors) Heavy duty aluminum box track & hardware for 1-1/8" (29mm) and 1-3/4" (44mm) thick doors.				
9890-30 - Bi-fold set for two 15" doors	30" (762 mm)	109.95	017732	6
9890-36 - Bi-fold set for two 18" doors	36" (914 mm)	114.50	017444	
9890-48 - Bi-fold set for two 24" doors	48" (1219 mm)	128.30	017439	
9891-48 - Bi-fold set for four 12" doors	48" (1219 mm)	195.20	017438	6
9891-60 - Bi-fold set for four 15" doors	60" (1524 mm)	205.85	017437	
9891-72 - Bi-fold set for four 18" doors	72" (1829 mm)	221.10	017436	
9891-96 - Bi-fold set for four 24" doors	96" (2438 mm)	243.25	017434	
9801-48 - Aluminum box track	48" (1219 mm)	AL 34.25	040426	6
9801-72 - Aluminum box track	72" (1829 mm)	AL 51.40	096641	
9801-96 - Aluminum box track	96" (2438 mm)	AL 69.05	096642	
9801-120 - Aluminum box track	120" (3048 mm)	AL 86.60	096643	
9801-144 - Aluminum box track	144" (3658 mm)	AL 113.05	096644	
9801-192 - Aluminum box track	192" (4877 mm)	AL 150.60	096645	
Components Description				
1741		US2D 2.00	029658	50
Full Mortise Plain Bearing Hinges with Screws 3-1/2" x 3-1/2"				
9827		41.85	018292	10
4 Wheel Ball bearing Hanger w/ Top Mount Plate				
9828		52.05	018286	10
Heavy Duty Pivot Set with 9815 Bumper Stop				



1. For additional components, refer to component section. 2. Items with the price in **bold and red** are Quick Ship items and ship in 24 hours. Please use stock number when ordering. 3. U/M is each unless otherwise noted. 4. Packaged sets and parts bags are available with optional components by special quotation.



Sliding Door Hardware - 9110 and 9130 - Pocket Door Framed Kits



Description	Finish	2021 List	Stock No.	Case Qty.
9110 Packaged Sets for doors up to 175 lbs (79 kg) per door.				
Contents: 9101 track, 9109 parts bag Heavy duty aluminum I-beam track & hardware for 1"(25mm) thick doors.				
9110-60 - Packaged set for 2'6" door	60" (1524 mm)	121.10	135334	5
9110-72 - Packaged set for 3'0" door	72" (1829 mm)	133.85	135335	
9110-84 - Packaged set for 3'6" door	84" (2134 mm)	145.80	135336	
9110-96 - Packaged set for 4'0" door	96" (2438 mm)	158.70	135337	
9110-120 - Packaged set for 5'0" door	120" (3048 mm)	163.40	135338	
9110-144 - Packaged set for 6'0" door	144" (3658 mm)	191.35	135339	
9130 Packaged Sets for doors up to 275 lbs (125 kg) per door.				
Contents: 9101 track, 9129 parts bag				
9130-60 - Packaged set for 2'6" door	60" (1524 mm)	154.70	135340	5
9130-72 - Packaged set for 3'0" door	72" (1829 mm)	165.85	135341	
9130-84 - Packaged set for 3'6" door	84" (2134 mm)	167.50	135342	
9130-96 - Packaged set for 4'0" door	96" (2438 mm)	182.60	135343	
9130-120 - Packaged set for 5'0" door	120" (3048 mm)	216.10	135344	
9130-144 - Packaged set for 6'0" door	144" (3658 mm)	241.15	135346	
9101-60 - I-beam track only, heavy duty aluminum	60" (1524 mm)	AL 56.50	023278	5
9101-72 - I-beam track only, heavy duty aluminum	72" (1829 mm)	AL 70.75	096508	
9101-84 - I-beam track only, heavy duty aluminum	84" (2134 mm)	AL 84.30	096509	
9101-96 - I-beam track only, heavy duty aluminum	96" (2438 mm)	AL 90.10	096707	
9101-120 - I-beam track only, heavy duty aluminum	120" (3048 mm)	AL 117.85	096511	
9101-144 - I-beam track only, heavy duty aluminum	144" (3658 mm)	AL 141.80	096512	
9101-192 - I-beam track only, heavy duty aluminum	192" (4877 mm)	AL 188.25	096513	
Parts Description				
9109 - 2 ea. 9102 two wheel hangers, 1 ea. 9115 floor guide. <i>*Up to 175 lbs (79 kg) per door.*</i>		58.70	135690	10
9129 - 2 ea. 9105 four wheel hangers, 1 ea. 9115 floor guide <i>*Up to 275 lbs (125 kg) per door.*</i>		86.60	135315	10
Components Description				
9102 2 Wheel Hanger - For use with 9101 track	US2C	25.75	135310	20
9105 4 Wheel Hanger - For use with 9101 track	US2C	38.65	135312	40
9115 Bottom Door Guide	US2C	9.15	096522	50



Sliding Door Hardware - 9628 | 9629 | 9630 | 9631 - Pocket Door Framed Kits



Description		Finish	2021 List	Stock No.	Case Qty.
9628 - For 3'0" wide x 9'0" high doors up to 75 lbs (68 kg) per door.	108" (2743 mm)	AL	253.10	136339	1
9629 - For 3'0" wide x 8'0" high doors up to 75 lbs (68 kg) per door.	96" (2134 mm)	AL	230.60	136341	1
9630 - For 3'0" wide x 7'0" high doors up to 75 lbs (68 kg) per door.	84" (2134 mm)	AL	225.90	136343	1
9631 - For 3'0" wide x 6'8" high doors up to 75 lbs (68 kg) per door.	80" (2032 mm)	AL	144.34	137180	1

Note: Packaged sets contents: 9601 track, 1 header assembly, 2 pair of split studs, 2 floor plates and 2 end brackets, 2 each 9606 ball bearing hangers w/ top mount plate, 1 each 9881 bumper, and 1 each 9883 door guide set. For 1-3/8" (35mm) and 1-3/4" (44 mm) thick doors.



Replacement Description					
9601-71 - Aluminum box track	71" (1803 mm)	AL	25.10	096578	10
9601-84 - Aluminum box track	84" (2134 mm)	AL	33.90	045141	
9601-96 - Aluminum box track	96" (2438 mm)	AL	38.90	096579	
9601-120 - Aluminum box track	120" (3048 mm)	AL	43.45	096580	
9601-144 - Aluminum box track	144" (3658 mm)	AL	51.40	096581	



9606 4 Wheel Ball Bearing Hanger w/ Top Mount Plate		US2D	17.85	135318	20
---	--	------	-------	--------	----



9881 Rubber Bumper			1.05	096685	80
------------------------------	--	--	------	--------	----



9883 2-Piece Door Guide set with screws			3.85	096686	100
---	--	--	------	--------	-----

1. For additional components, refer to component section. 2. Items with the price in **bold and red** are Quick Ship items and ship in 24 hours. Please use stock number when ordering. 3. U/M is each unless otherwise noted. 4. Packaged sets and parts bags are available with optional components by special quotation.



Sliding Door Hardware - 9678 Packaged Sets - Pocket Door



Description	Finish	2021 List	Stock No.	Case Qty.		
9678 Packaged Sets up to 125 lbs. (57 kg) per door.						
Contents: 9601 track, 9632 parts bag. For 1-3/8" (35mm) and 1-3/4" (44mm) thick doors. Heavy duty Aluminum box track & hardware						
9678-72 - Pocket set for 3' door		72" (1829 mm)	85.70	136354	6	
9678-96 - Pocket set for 4' door		96" (2438 mm)	102.65	136356		
9601-71 - Box track only, heavy duty aluminum		71" (1803 mm)	AL	25.10	096578	6
9601-84 - Box track only, heavy duty aluminum		84" (2134 mm)	AL	33.90	045141	
9601-96 - Box track only, heavy duty aluminum		96" (2438 mm)	AL	38.90	096579	
9601-120 - Box track only, heavy duty aluminum		120" (3048 mm)	AL	43.45	096580	
9601-144 - Box track only, heavy duty aluminum		144" (3658 mm)	AL	51.40	096581	
Parts Description						
9632 - 2 ea. 9605 hangers w/ top mount plate, 1 ea. 9883 door guide, 1 ea. 9881 bumper. <i>*Up to 125 lbs (57 kg) per door.*</i>			33.90	135322	10	
9633 - 2 ea. 9606 ball bearing hangers w/ top mount plate, 1 ea. 9883 door guide, 1 ea. 9881 bumper. <i>*Up to 150 lbs (69 kg) per door.*</i>			56.20	135323		
Components Description						
9605 4 Wheel Hanger w/ Top Mount Plate	US2D		5.75	135317	20	
9606 4 Wheel Ball Bearing Hanger w/ Top Mount Plate	US2D		17.85	135318	20	
9881 Rubber Bumper			1.05	096685	80	
9883 2-Piece Door Guide set with screws			3.85	096686	100	

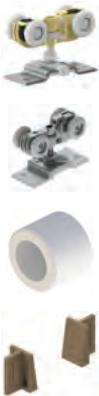

Sliding Door Hardware - 9850 Pocket Door Framed Kit



Description	Finish	2021 List	Stock No.	Case Qty.	
9850 - For 4'0" wide x 8'0" high doors, up to 250 lbs.(113 kg) per door.	AL	405.05	139083	1	
9850 - For 4'0" wide x 8'6" high doors, up to 250 lbs.(113 kg) per door.	AL	472.25	139085	1	
Note: Packaged sets contents: 9801 track, 1 header assembly, 3 pairs of split studs, 2 each 9827 hangers w/ top mount plate, 1 ea. 9881 bumper, 1ea. 9883 door guide set, 3 floor plates and 2 end brackets. For 1-3/8"(35mm) and 1-3/4"(44mm) thick doors.					
Replacement Description					
9801-72 - Box Track only, Heavy Duty Aluminum	72" (1829 mm)	AL	51.40	096641	5
9801-96 - Box Track only, Heavy Duty Aluminum	96" (2438 mm)	AL	69.05	096642	
9801-120 - Box Track only, Heavy Duty Aluminum	120" (3048 mm)	AL	86.60	096643	
9801-144 - Box Track only, Heavy Duty Aluminum	144" (3658 mm)	AL	113.05	096644	
9801-192 - Box Track only, Heavy Duty Aluminum	192" (4877 mm)	AL	150.60	096645	
9827 4 Wheel Ball bearing Hanger w/ Top Mount Plate			41.85	018292	10
9881 Rubber Bumper			1.05	096685	80
9883 2-Piece Door Guide set with screws			3.85	096686	100



1. For additional components, refer to component section. 2. Items with the price in **bold and red** are Quick Ship items and ship in 24 hours. Please use stock number when ordering. 3. U/M is each unless otherwise noted. 4. Packaged sets and parts bags are available with optional components by special quotation.



Sliding Door Hardware - 9878 Packaged Sets - Pocket Door



Description	Finish	2021 List	Stock No.	Case Qty.		
9878 Packaged Sets for doors up to 250 lbs. (113 kg) per door.						
For doors 1-3/8" (35 mm) thick and up. Contents: 9801 track, 9742 parts bag						
9878-72 - Pocket set for 3' door		72" (1829 mm)	139.00	137425	6	
9878-96 - Pocket set for 4' door		96" (2438 mm)	185.20	137426		
9801-72 - Box track only, heavy duty aluminum		72" (1829 mm)	AL	51.40	096641	10
9801-96 - Box track only, heavy duty aluminum		96" (2438 mm)	AL	69.05	096642	
9801-120 - Box track only, heavy duty aluminum		120" (3048 mm)	AL	86.60	096643	
9801-144 - Box track only, heavy duty aluminum		144" (3658 mm)	AL	113.05	096644	
9801-192 - Box track only, heavy duty aluminum		192" (4877 mm)	AL	150.60	096645	
Parts Description						
9742 - 2 ea. 9827 hangers w/ top mount plate, 1 ea. 9883 guide set, 1 ea. 9881 bumper			88.30	137418	10	
Components Description						
9827 4 Wheel Ball bearing Hanger w/ Top Mount Plate			41.85	018292	10	
9881 Rubber Bumper			1.05	096685	80	
9883 2-Piece Door Guide set with screws			3.85	096686	100	



Sliding Door Hardware - 9901 Packaged Sets - Pocket Door



Description	Finish	2021 List	Stock No.	Case Qty.
9901 Packaged Sets for doors up to 250 lbs. (113 kg)				
Contents: 9821 track, 9895 parts bag Extra heavy duty Aluminum box track & hardware for 1-3/8"(35mm) and 1-3/4"(44mm) thick doors.				
9901-72 - Pocket set for 3' doors	72" (1829 mm)	146.00	019361	6
9901-96 - Pocket set for 4' doors	96" (2438 mm)	163.40	019358	
9821-59 - Aluminum box track	59" (1499 mm)	AL 31.85	019084	10
9821-71 - Aluminum box track	71" (1803 mm)	AL 39.45	019062	
9821-96 - Aluminum box track	96" (2438 mm)	AL 52.60	019061	
9821-144 - Aluminum box track	144" (3658 mm)	AL 76.20	019050	
Parts Description				
9895 - 2 ea. 9825 hangers w/ top mount plate, 1 ea. 9883 guide set, 1 ea. 9881 bumper		72.00	019408	10
Components Description				
9825 Ball Bearing Hanger w/ Top Mount Plate		36.00	135321	10
9881 Rubber Bumper		1.05	096685	80
9883 2-Piece Door Guide set with screws		3.85	096686	100



1. For additional components, refer to component section. 2. Items with the price in **bold and red** are Quick Ship items and ship in 24 hours. Please use stock number when ordering. 3. U/M is each unless otherwise noted. 4. Packaged sets and parts bags are available with optional components by special quotation.



Sliding Door Hardware - 9710 Packaged Sets- Wall-Mount

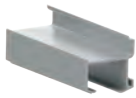

Description	Finish	2021 List	Stock No.	Case Qty.
9710 Packaged Sets for heavy duty single doors and bi-parting doors up to 250 lbs. (113kg)				
Contents of Packaged Sets: 9703 track, 9704 fascia, 9705 end caps and 9711 parts bags. (2 ea. 9711 parts bags included in 144" pkg set.) Heavy duty aluminum wall-mount box track, anodized fascia, end caps and hardware for 1" (25mm and 1-3/4" (44mm) thick doors.				
9710-60 - Wall-Mount Packaged Set for 1 Door	60" (1524 mm)	CLA	228.75 160955	1
9710-72 - Wall-Mount Packaged Set for 1 Door	72" (1829 mm)	CLA	242.75 160958	
9710-96 - Wall-Mount Packaged Set for 1 Door	96" (2438 mm)	CLA	280.10 160959	
9710-144 - Wall-Mount Packaged Set for 1 or 2 Doors	144" (3658 mm)	CLA	466.80 160991	
9710-60 - Wall-Mount Packaged Set for 1 Door	60" (1524 mm)	DBA	285.95 160961	1
9710-72 - Wall-Mount Packaged Set for 1 Door	72" (1829 mm)	DBA	303.45 160962	
9710-96 - Wall-Mount Packaged Set for 1 Door	96" (2438 mm)	DBA	350.10 160963	
9710-144 - Wall-Mount Packaged Set for 1 or 2 Doors	144" (3658 mm)	DBA	594.40 160989	
9703-60 - Wall-Mount Track-mill finish	60" (1524 mm)	ALM	68.65 160984	5
9703-72 - Wall-Mount Track-mill finish	72" (1829 mm)	ALM	72.85 160985	
9703-96 - Wall-Mount Track-mill finish	96" (2438 mm)	ALM	84.05 160986	
9703-144 - Wall-Mount Track-mill finish	144" (3658 mm)	ALM	161.25 160988	
9703-60 - Wall-Mount Track- dark bronze anodized	60" (1524 mm)	DBA	106.10 160993	5
9703-72 - Wall-Mount Track- dark bronze anodized	72" (1829 mm)	DBA	113.00 160994	
9703-96 - Wall-Mount Track- dark bronze anodized	96" (2438 mm)	DBA	130.55 160995	
9703-144 - Wall-Mount Track- dark bronze anodized	144" (3658 mm)	DBA	250.40 160996	
9704-60 - Wall-Mount Fascia- clear anodized	60" (1524 mm)	CLA	89.25 161003	5
9704-72 - Wall-Mount Fascia- clear anodized	72" (1829 mm)	CLA	94.75 161004	
9704-96 - Wall-Mount Fascia- clear anodized	96" (2438 mm)	CLA	109.30 161005	
9704-144 - Wall-Mount Fascia- clear anodized	144" (3658 mm)	CLA	210.10 161006	
9704-60 - Wall-Mount Fascia-dark bronze anodized	60" (1524 mm)	DBA	137.95 161009	5
9704-72 - Wall-Mount Fascia-dark bronze anodized	72" (1829 mm)	DBA	147.15 161010	
9704-96 - Wall-Mount Fascia-dark bronze anodized	96" (2438 mm)	DBA	169.50 161011	
9704-144 - Wall-Mount Fascia-dark bronze anodized	144" (3658 mm)	DBA	324.70 161012	
Parts Description				
9705 - End Cap Set- anodized		CLA	70.05 161013	10
		DBA	84.05 161014	10
9711 - Parts Bag: 2 ea. 9827 hangers w/ top mount plate, 1 ea. 9115 bottom door guide, 4 ea 9815 bumper stops			69.00 161015	10
Components Description				
9115 Bottom Door Guide		US2C	9.15 096522	50
9815 Bumper Stop			7.35 096648	20
9827 4 Wheel Ball Bearing Hanger w/ Top Mount Plate			41.85 018292	10



Sliding Door Hardware - Components



Description	Finish	2021 List	Stock No.	Case Qty.
330D	US3	12.15	086840	20
Pocket Door Latch	US5	12.15	086841	
Material: Cast brass	US10	13.60	066707	
Fits: 1-3/8" - 1-3/4" door	US10B	15.15	056768	
Size: 2-3/4" x 2-1/2"	US15	12.15	078972	
Finger Pull Extends: 1-3/8"	US15A	12.95	054061	
Fasteners: #6 x 5/8" OPHWS	US19	7.70	054570	
	US26	12.15	086837	
	US26D	12.95	086838	



330L	US3	14.20	143162	20
Privacy Pocket Door Latch	US5	14.55	143164	
Material: Brass	US10	9.85	014365	
Size: 2-3/4" x 2-1/2"	US10B	17.20	143158	
Finger Pull Extends: 1-3/8"	US15	14.65	143159	
Strike: 1" x 2-1/4"	US15A	14.55	143160	
1-3/8" doors	US19	14.55	143166	
Fasteners: #6 x 5/8" OPHWS; #6 x 3/4" FPHWS	US26	14.20	143167	
	US26D	14.95	143161	



330M	US3	15.00	143172	20
Privacy Pocket Door Latch	US5	26.00	143178	
Material: Brass	US10	34.60	143168	
Size: 2-3/4" x 2-1/2"	US10B	15.90	143169	
Finger Pull Extends: 1-3/8"	US15	34.60	143173	
Strike: 1" x 2-1/4"	US15A	34.60	143174	
1-3/4" doors	US19	34.60	143175	
Fasteners: #6 x 5/8" OPHWS; #6 x 3/4" FPHWS	US26	15.00	143170	
	US26D	14.15	143171	



1741	US2D	2.00	029658	50
Full Mortise Plain Bearing				
Hinges with Screws				
3-1/2" x 3-1/2"				



2610	US3	1.00	013049	500
Finger Pull	US4	1.00	071953	
Material: Brass	US5	1.00	067282	
Overall Diameter: 31/32"	US10A	1.00	068711	
Finger Pull Diameter: 3/4"	US15	1.00	040589	
Pull Clearance: 5/16"	US15A	1.00	040590	
Projection: 1/32"	US26	1.00	013047	
	US26D	1.00	071169	













2620	US3	1.65	013081	50
Round Flush Pull	US4	1.65	072997	
Material: Brass	US5	1.65	072148	
Overall Diameter: 31/32"	US10A	1.65	072534	
Finger Pull Diameter: 1-11/16"	US15	1.65	072624	
Pull Clearance: 11/32"	US15A	1.65	072158	
Projection: 5/64"	US26	1.65	072554	
	US26D	1.65	075322	

1. For additional components, refer to component section. 2. Items with the price in **bold and red** are Quick Ship items and ship in 24 hours. Please use stock number when ordering. 3. U/M is each unless otherwise noted. 4. Packaged sets and parts bags are available with optional components by special quotation.



Sliding Door Hardware - Components

	Description	Finish	2021 List	Stock No.	Case Qty.	
	2630	US3	4.30	051919	50	
	Round Flush Pull	US4	4.30	073783		
	Material: Brass	US5	4.30	053163		
	Overall Diameter: 2-7/16"	US10A	4.30	073053		
	Finger Pull Diameter: 2-1/16"	US15	4.30	073056		
	Pull Clearance: 11/32"	US15A	4.30	005307		
	Projection: 3/32"	US26	4.30	023430		
		US26D	4.30	023431		
	2640	US3	6.05	096760	50	
	Oblong Flush Pull	US4	6.05	075056		
	Material: Brass	US5	6.05	074270		
	Size: 1-5/16" x 2-3/4"	US10A	6.05	074533		
	Cup Clearance: 5/16"	US15	6.05	074711		
	Fasteners: #6 x 5/8" OPHWS	US15A	6.05	074350		
		US26	6.05	026751		
		US26D	6.05	074664		
	9101-60	60" (1524 mm)	AL	56.50	023278	5
	I-beam track, heavy duty aluminum	72" (1829 mm)	AL	70.75	096508	
		84" (2134 mm)	AL	84.30	096509	
		96" (2438 mm)	AL	90.10	096707	
		120" (3048 mm)	AL	117.85	096511	
		144" (3658 mm)	AL	141.80	096512	
		192" (4877 mm)	AL	188.25	096513	
	9102	US2C	25.75	135310	20	
2 Wheel Hanger						
	9105	US2C	38.65	135312	40	
4 Wheel Hanger						
	9109		58.70	135690	10	
Parts Bag: 2 ea. 9102 two wheel hangers, 1 ea. 9115 floor guide						
	9111	US2C	4.25	096516	20	
Bottom Roller Guide						
	9113	AL	55.55	135314	10	
Stop						
	9114-72 - Bottom Guide Track- 72"	72" (1829 mm)	AL	41.85	096519	5
	9114-96 - Bottom Guide Track- 96"	96" (2438 mm)	AL	55.55	096520	5
	9114-144 - Bottom Guide Track- 144"	144" (3658 mm)	AL	83.45	096521	5
	9115	US2C	9.15	096522	50	
Bottom Door Guide						



Sliding Door Hardware - Components





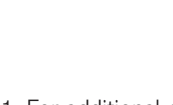
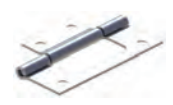





Description	Finish	2021 List	Stock No.	Case Qty.
9121 Roller Guide - For use with 9122 guide	US2C	17.15	137181	20
9122-48 - Bottom Guide Channel - 3/4" wide x 5/8" tall	AL	21.80	096557	5
9122-60 - Bottom Guide Channel - 3/4" wide x 5/8" tall	AL	27.45	096558	5
9122-72 - Bottom Guide Channel - 3/4" wide x 5/8" tall	AL	32.20	096559	5
9122-96 - Bottom Guide Channel - 3/4" wide x 5/8" tall	AL	42.70	096560	5
9122-120 - Bottom Guide Channel - 3/4" wide x 5/8" tall	AL	53.80	096605	5
9122-132 - Bottom Guide Channel - 3/4" wide x 5/8" tall	AL	58.70	096606	5
9122-144 - Bottom Guide Channel - 3/4" wide x 5/8" tall	AL	64.20	096607	5
9122-192 - Bottom Guide Channel - 3/4" wide x 5/8" tall	AL	85.70	096608	5
9128 Bottom Pivot Bolt and Door Plate with Bottom Pivot Floor Bracket	US2C	40.80	023150	10
9129 Parts Bag: 2 ea. 9105 4-wheel hangers, 1 ea. 9115 floor guide		86.60	135315	10
9169 Top Pivot Assembly	US2C	9.15	096635	10
9200 Hanger - Small 3/8" (10 mm) offset A		1.90	016575	100
9201 Hanger - Large 11/16" (18 mm) offset B	US2C	1.90	096561	100
9202 Twin Wheel Hanger - Large 11/16" (18 mm) offset B	US2C	3.45	096562	100
9220 Non-Mortise Bi-Fold Hinge with Screws	US2D	1.90	099119	600
9262 - Keyed Lock for pocket door applications	US3	45.05	098994	6
	US26D	46.20	016724	
9264 - Keyed Lock for bifold applications	US3	38.65	016725	6
Keyed Lock - Keyed Alike	US3	38.65	002801	



1. For additional components, refer to component section. 2. Items with the price in **bold and red** are Quick Ship items and ship in 24 hours. Please use stock number when ordering. 3. U/M is each unless otherwise



Sliding Door Hardware - Components

Description	Finish	2021 List	Stock No.	Case Qty.
 9268 - Keyed Lock for bypass applications	US3	43.45	016726	6
	US26D	44.25	099251	
	US3	43.45	002804	6
	US26D	44.25	002802	
Keyed Lock - Keyed Alike				
9351 Door Guide		2.75	096563	50
 9353 Adjustable Door Guide		2.75	096564	20
 9354 Carpet Riser	US2D	1.90	096565	50
 9400 Cam Adjustable Hanger - Small 3/8" (10 mm) offset A	US2C	3.45	017417	100
 9401 Cam Adjustable Hanger - Large 1 1/16" (18 mm) offset B	US2C	3.45	096566	100
 9540 Parts Bag: 4 ea. 9401 hangers, 2 ea. 2610 pulls, 1 ea. 9351 guide		9.85	017419	10
 9544 Parts Bag: 4 ea. 9202 hangers, 2 ea. 2630 pulls, 1 ea. 9351 guide Used to increase door weight capacity to 75 lbs		14.60	017035	10
 9558 Wood Knob Knob Diameter: 1-1/2" Base Diameter: 15/16" Fasteners: #8 x 1-3/4" PPHWS	Wood	1.90	096567	100
 9559 Aligner	US2D	1.05	096568	200
 9566 Knob Material: Zinc Knob Diameter: 1-1/4" Projection: 1" Fasteners: #8 - 32 x 2" PPHMS; #8 - 32 x 1-3/4" PPHMS	US3 US4 US10A US10B US15 US15A US26 US26D	7.05 7.90 7.90 7.90 7.90 7.90 7.05 7.90	099824 098635 098634 098633 098632 098629 098628 098627	100



Sliding Door Hardware - Components



Description	Finish	2021 List	Stock No.	Case Qty.	
9567 Rose - For use with 9566 knob Material: Zinc Base Diameter: 1-3/4" Projection: 15/32" Fasteners: #8 - 32 x 2" PPHMS; #8 - 32 x 1-3/4" PPHMS	US3 US10A US10B US15 US26 US26D	3.30 3.30 3.30 3.30 3.30 3.55	099825 098625 098624 098623 098621 098620	100	
9569 Parts Bag: 1 ea. 9572 hanger w/ top mount plate, 9618 pivot set, 9559 aligner, 9558 knob and 9815 bumper stop, 3 ea. 9220 hinges		24.25	016913	10	
9572 4-Wheel Hanger w/ Top Mount Plate	US2D	12.25	135316	20	
9573 Spacer Kit - 3/8" use with 9821 track - For doors 1-3/4" thick		5.10	019014	5	
9574 Spacer Kit - For use with 9801 - For doors 1-3/8" and 1-3/4" thick		5.10	015991	5	
9575 Parts Bag: 4 ea. 9572 hangers w/ top mount plate, 1 ea. 9909 guide		28.30	137167	5	
9601-71 - Aluminum box track	71" (1803 mm)	AL	25.10	096578	
9601-84 - Aluminum box track	84" (2134 mm)	AL	33.90	045141	
9601-96 - Aluminum box track	96" (2438 mm)	AL	38.90	096579	
9601-120 - Aluminum box track	120" (3048 mm)	AL	43.45	096580	
9601-144 - Aluminum box track	144" (3658 mm)	AL	51.40	096581	
9602-46 - Double box track only, heavy duty aluminum	46" (1168 mm)	AL	33.90	096582	5
9602-58 - Double box track only, heavy duty aluminum	58" (1473 mm)	AL	41.85	096583	
9602-70 - Double box track only, heavy duty aluminum	70" (1778 mm)	AL	48.30	096584	
9602-94 - Double box track only, heavy duty aluminum	94" (2388 mm)	AL	62.60	096585	
9602-118 - Double box track only, heavy duty aluminum	118" (2997 mm)	AL	75.45	096586	
9602-142 - Double box track only, heavy duty aluminum	142" (3607 mm)	AL	89.85	096587	

1. For additional components, refer to component section. 2. Items with the price in **bold and red** are Quick Ship items and ship in 24 hours. Please use stock number when ordering. 3. U/M is each unless otherwise noted. 4. Packaged sets and parts bags are available with optional components by special quotation.



Sliding Door Hardware - Components

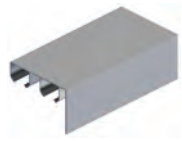

Description	Finish	2021 List	Stock No.	Case Qty.
9603-48 - Aluminum box track with fascia	AL	62.60	135288	5
9603-60 - Aluminum box track with fascia	AL	75.45	135289	
9603-72 - Aluminum box track with fascia	AL	89.85	135290	
9603-96 - Aluminum box track with fascia	AL	117.15	135291	
9603-120 - Aluminum box track with fascia	AL	146.70	029359	
9603-144 - Aluminum box track with fascia	AL	180.35	029360	
9605 4-Wheel Hanger w/ Top Mount Plate	US2D	5.75	135317	20
9606 4-Wheel Ball Bearing w/ Top Mount Plate	US2D	17.85	135318	20
9610 Replacement Top Mount Plate	US2C	1.90	142410	20
9618 Pivot Set - For 9570 series	-	8.35	137182	10
9632 Pocket Parts Bag - 125 lbs (57 kg) Consists of: 2 ea. 9605 hangers w/ top mount plate, 1 ea. 9883 guide set, 1 ea. 9881 bumper		33.90	135322	10
9633 Parts Bag : 2 ea. 9606 ball bearing hangers w/ top mount plate, 1 ea. 9883 guide set, 1 ea. 9881 bumper		56.20	135323	10
9634 Pocket Door Adapter Kit For 1-3/4" (45 mm) thick doors		8.80	097519	10
9639 Double Pocket Door Adapter Kit Joins two frames in middle of doorway	US2C	25.10	096595	1
9679 4 ea. 9605 hangers w/ top mount plate, 1 ea. 9909 guide		39.45	137179	20
9680 4 ea. 9606 ball bearing hangers w/ top mount plate, 1 ea. 9909 guide		93.05	136357	20



Sliding Door Hardware - Components

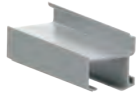

Description		Finish	2021 List	Stock No.	Case Qty.
9703-60 - Wall-Mount Track-mill finish	60" (1524 mm)	ALM	68.65	160984	5
9703-72 - Wall-Mount Track-mill finish	72" (1829 mm)	ALM	72.85	160985	
9703-96 - Wall-Mount Track-mill finish	96" (2438 mm)	ALM	84.05	160986	
9703-144 - Wall-Mount Track-mill finish	144" (3658 mm)	ALM	161.25	160988	
9703-60 - Wall-Mount Track- dark bronze anodized	60" (1524 mm)	DBA	106.10	160993	5
9703-72 - Wall-Mount Track- dark bronze anodized	72" (1829 mm)	DBA	113.00	160994	
9703-96 - Wall-Mount Track- dark bronze anodized	96" (2438 mm)	DBA	130.55	160995	
9703-144 - Wall-Mount Track- dark bronze anodized	144" (3658 mm)	DBA	250.40	160996	
9704-60 - Wall-Mount Fascia- clear anodized	60" (1524 mm)	CLA	89.25	161003	5
9704-72 - Wall-Mount Fascia- clear anodized	72" (1829 mm)	CLA	94.75	161004	
9704-96 - Wall-Mount Fascia- clear anodized	96" (2438 mm)	CLA	109.30	161005	
9704-144 - Wall-Mount Fascia- clear anodized	144" (3658 mm)	CLA	210.10	161006	
9704-60 - Wall-Mount Fascia-dark bronze anodized	60" (1524 mm)	DBA	137.95	161009	5
9704-72 - Wall-Mount Fascia-dark bronze anodized	72" (1829 mm)	DBA	147.15	161010	
9704-96 - Wall-Mount Fascia-dark bronze anodized	96" (2438 mm)	DBA	169.50	161011	
9704-144 - Wall-Mount Fascia-dark bronze anodized	144" (3658 mm)	DBA	324.70	161012	
9705 - End Cap Set- anodized		CLA	70.05	161013	10
		DBA	84.05	161014	10
9709-60 - Fascia only, 2-3/4" (70 mm) wide	60" (1524 mm)	AL	53.10	023322	
9709-72 - Fascia only, 2-3/4" (70 mm) wide	72" (1829 mm)	AL	60.95	096603	
9709-96 - Fascia only, 2-3/4" (70 mm) wide	96" (2438 mm)	AL	69.05	096604	
9711			69.00	161015	10
Parts Bag: 2 ea. 9827 hangers w/ top mount plate, 1 ea. 9115 bottom door guide, 4 ea. 9815 bumper stops					
9742			88.30	137418	10
Parts Bag: 2 ea. 9816 hangers w/ top mount plate, 1 ea. 9883 guide set, 1 ea. 9881 bumper					
9801-72 - Box Track, Heavy Duty Aluminum	72" (1829 mm)	AL	51.40	096641	5
9801-96 - Box Track, Heavy Duty Aluminum	96" (2438 mm)	AL	69.05	096642	
9801-120 - Box Track, Heavy Duty Aluminum	120" (3048 mm)	AL	86.60	096643	
9801-144 - Box Track, Heavy Duty Aluminum	144" (3658 mm)	AL	113.05	096644	
9801-192 - Box Track, Heavy Duty Aluminum	192" (4877 mm)	AL	150.60	096645	

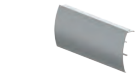

1. For additional components, refer to component section. 2. Items with the price in **bold and red** are Quick Ship items and ship in 24 hours. Please use stock number when ordering. 3. U/M is each unless otherwise noted. 4. Packaged sets and parts bags are available with optional components by special quotation.



Sliding Door Hardware - Components



Description	Finish	2021 List	Stock No.	Case Qty.
9803-60 - Double Box Track w/ Fascia, Heavy Duty Aluminum 60" (1524 mm)	AL	134.70	022483	2
9803-72 - Double Box Track w/ Fascia, Heavy Duty Aluminum 72" (1829 mm)	AL	160.30	022484	
9803-96 - Double Box Track w/ Fascia, Heavy Duty Aluminum 96" (2438 mm)	AL	214.60	022485	
9803-120 - Double Box Track w/ Fascia, Heavy Duty Aluminum 120" (3048 mm)	AL	267.50	022486	
9803-144 - Double Box Track w/ Fascia, Heavy Duty Aluminum 144" (3658 mm)	AL	321.25	022487	
9809-72 - Aluminum Fascia, 3-7/8" (98 mm) high 72" (1829 mm)	AL	95.45	096646	10
9809-96 - Aluminum Fascia, 3-7/8" (98 mm) high 96" (2438 mm)	AL	125.00	096647	
9810-46 - Aluminum Track 46-3/8" (1178 mm)	AL	16.30	019702	10
9810-58 - Aluminum Track 58-3/8" (1483 mm)	AL	19.45	019703	
9810-70 - Aluminum Track 70-3/8" (1788 mm)	AL	23.60	019704	
9810-93 - Aluminum Track 93-3/8" (2372 mm)	AL	30.55	019705	
9810-120 - Aluminum Track 120" (3048 mm)	AL	38.65	016570	
9810-144 - Aluminum Track 144" (3658 mm)	AL	51.40	026064	
9814 Parts bag: 2 ea. 9400 hangers, 2 ea. 9401 hangers, 2 ea. 2610 pulls, 1 ea. 9353 guide set. For 1" to 1-1/8" doors, specify 9841 parts bag.		15.40	016772	10
9815 Bumper Stop		7.35	096648	20



Sliding Door Hardware - Components



Description	Finish	2021 List	Stock No.	Case Qty.
9820-48 - Aluminum track with 1-3/4" grooved fascia	AL	29.95	000461	5
9820-60 - Aluminum track with 1-3/4" grooved fascia	AL	37.15	000462	
9820-72 - Aluminum track with 1-3/4" grooved fascia	AL	43.45	000463	
9820-84 - Aluminum track with 1-3/4" grooved fascia	AL	58.70	028175	
9820-96 - Aluminum track with 1-3/4" grooved fascia	AL	64.20	099664	
9820-120 - Aluminum track with 1-3/4" grooved fascia	AL	73.95	000464	
9820-144 - Aluminum track with 1-3/4" grooved fascia	AL	96.30	000460	
9821-59 - Aluminum box track	AL	31.85	019084	10
9821-71 - Aluminum box track	AL	39.45	019062	
9821-96 - Aluminum box track	AL	52.60	019061	
9821-144 - Aluminum box track	AL	76.20	019050	
9824 4-Wheel Hanger w/ Top Mount Plate		28.65	135320	20
9825 4-Wheel Ball Bearing Hanger w/ Top Mount Plate		36.00	135321	10
9827 4-Wheel Ball bearing Hanger w/ Top Mount Plate		41.85	018292	10
9828 Heavy Duty Pivot Set with 9815 Bumper Stop		52.05	018286	10
9841 Parts Bag: 4 ea. 9402 hangers, 2 ea. 9865 pulls, 1 ea. 9351 guide		8.35	099665	10
9842 Parts Bag: 4 ea. 9402 hangers, 2 ea. 9630 pulls, 1 ea. 9351 guide		11.45	017424	10



1. For additional components, refer to component section. 2. Items with the price in **bold and red** are Quick Ship items and ship in 24 hours. Please use stock number when ordering. 3. U/M is each unless otherwise noted. 4. Packaged sets and parts bags are available with optional components by special quotation.



Sliding Door Hardware - Components



Description	Finish	2021 List	Stock No.	Case Qty.
9843 Parts Bag: 4 ea. 9401 hangers, 2 ea. 9865 pulls, 1 ea. 9351 guide. Used to increase door weight capacity to 75 lbs		13.05	016912	10
9865 Plastic Pull Overall Diameter: 1-31/32" Finger Pull Diameter: 1-19/32" Pull Clearance: 11/32" Projection: 5/64"	Plastic	1.05	098993	50
9877 Door Guide, 2 pieces required per door		1.90	016843	50
9880 Stop	US2C	1.90	096684	10
9881 Rubber Bumper		1.05	096685	80
9882 Pocket Door Edge Pull Material: Brass Finger Pull Extends: 3/4" Faceplate: 3/4" x 3-7/8" Fasteners: #6 x 5/8" FPHWS	US3 US4 US10 US10B US26 US26D	15.05 18.20 15.05 18.20 18.20 18.20	049582 049583 049578 049580 049579 049581	100
9883 2-Piece Door Guide Set with Screws		3.85	096686	100
9884 Pocket Door Edge Pull Material: Zinc Finger Pull Extends: 1-1/16" Faceplate: 2 1/32" x 3-1/2" Fasteners: #6 x 5/8" FPHWS	US3	8.00	099056	40
9889 1-Piece Guide		1.90	096687	20



Sliding Door Hardware - Components



Description	Finish	2021 List	Stock No.	Case Qty.
9892 Parts Bag: 4 ea. 9824 4-wheel hangers w/ top mount plate, 1 ea. 9909 guide, 1 ea. 9573 spacer kit		54.30	019421	10



9893 Parts Bag: 4 ea. 9825 4-wheel ball bearing hangers w/ top mount plate, 1 ea. 9909 guide, 1 ea. 9573 spacer kit		101.60	019418	10
---	--	--------	--------	----



9894 Parts Bag: 1 ea. 9825 4-wheel ball bearing hanger w/ top mount plate, 1 ea. 9828 pivot set with 9815 bumper stop, 9559 aligner		90.65	019435	10
---	--	-------	--------	----



9895 Parts Bag: 2 ea. 9825 4-wheel ball bearing hangers w/ top mount plate, 1 ea. 9883 guide, 1 ea. 9881 bumper		72.00	019408	10
---	--	-------	--------	----



9900 Reversible Side Mount Bracket	US2C	7.35	003775	20
--	------	------	--------	----

9909 Heavy Duty Adjustable Door Guide From 3/4" to 1-3/4" (19 mm to 44 mm)	US2C	8.35	097528	20
---	------	------	--------	----

1. For additional components, refer to component section. 2. Items with the price in **bold and red** are Quick Ship items and ship in 24 hours. Please use stock number when ordering. 3. U/M is each unless otherwise noted. 4. Packaged sets and parts bags are available with optional components by special quotation.



Sliding Door Hardware - 9400 Series Stainless Barn Door

Description	Length	Finish	Year List	Stock No.	Case Qty.
-------------	--------	--------	-----------	-----------	-----------



9432 Packaged Sets - Top Mount Stick 2m SS Round Rail

Includes stainless steel track with two end caps, hangers with wall brackets, one bottom door guide, two track stops, mounting and installation hardware

9432-78 - Top Mount Stick 2m (78-3/4") SS Round Rail		32D	540.75	183635	1
9432-96 - Top Mount Stick 2m (96-3/4") SS Round Rail		32D	628.30	183636	1



9436 Packaged Sets - Face Mount Strap Stick 2m SS Round Rail

Includes stainless steel track with two end caps, hangers with wall brackets, one bottom door guide, two track stops, mounting and installation hardware

9436-78 - Face mount Strap Stick 2m (78-3/4") SS Round Rail		32D	597.40	183643	1
9436-96 - Face mount Strap Stick 2m (96-3/4") SS Round Rail		32D	623.15	183644	1



Sliding Door Hardware- Stainless Barn Door Components



Description	Length	Finish	Year List	Stock No.	Case Qty.
1-269-8650 Spring Loaded Cushion Stop for 9400 Barn Door Series I		32D	27.50	86376	1
1-269-8663 Round Rail Connector SS304 satin nickel		32D	33.95	181901	1
1-269-8664 Flat Rail Connector SS304 satin nickel		32D	33.95	181902	1
1-269-8665 Tool set for O5WG; O6WG; O7WG (round rail)			3.60	183156	1
1-269-8666 Tool set for O1W; O2W (round rail)		32D	3.60	183163	1
1-269-8667 End Cap		32D	9.10	183164	1
1-269-8668 Guide for wood door			5.70	183165	1
1-269-8669 Door Stop		32D	39.65	183166	1
1-269-8670 Guide for glass door		32D	28.35	183167	1
1-269-8671 Top Mount Stick Sliding Door Roller for Wood, SS304 Satin		32D	141.50	183168	1
1-269-8672 Top Mount Dual Wheel Sliding Door Roller for Wood, SS304 Satin		32D	396.10	183170	1
1-269-8673 Top Mount Spoke Wheel Sliding Door Roller for Wood, SS304 Satin		32D	339.50	183171	1
1-269-8674 Strap Stick Sliding Door Roller for Wood and Glass, SS304 Satin		32D	282.95	183172	1
1-269-8675 Strap Dual Wheel Sliding Door Roller for Wood and Glass, SS304 Satin		32D	481.00	183173	1

1. For additional components, refer to component section. 2. Items with the price in **bold and red** are Quick Ship items and ship in 24 hours. Please use stock number when ordering. 3. U/M is each unless otherwise noted. 4. Packaged sets and parts bags are available with optional components by special quotation.





Description	Length	Finish	Year List	Stock No.	Case Qty.
1-269-8676 Strap Triangle Sliding Door Roller for Wood and Glass, SS304 Satin		32D	339.50	183176	1
1-269-8677 Flat Rail Stick Sliding Door Carrier for Wood SS304 Satin		32D	189.60	183179	1
1-269-8678 Flat Rail Door Stopper Left, SS304 Satin		32D	56.60	183180	1
1-269-8679 Flat Rail Door Stopper Right, SS304 Satin		32D	56.60	183181	1
1-269-8680 Flat Rail Anti Jump		32D	3.40	183182	1



eConestoga Barn Door Hardware Series



Description	Finish	2021 List	Stock No.
9456-72 Flat Rail Steel Black Top Mount 72" Track Kit Includes Track	BLK	218.90	96467



9456-96 Flat Rail Steel Black Top Mount 96" Track Kit Includes Track	BLK	244.65	96466
---	-----	--------	-------



9457-72 Flat Rail Steel Black 3" Hook 72" Track Kit Includes Track	BLK	244.65	96427
---	-----	--------	-------



9457-96 Flat Rail Steel Black 3" Hook 96" Track Kit Includes Track	BLK	270.40	96388
---	-----	--------	-------



1-269-8649 Flat Rail Track Connector	BLK	12.90	96361
--	-----	-------	-------



1-269-8648 72" Rail Only	BLK	91.15	96355
------------------------------------	-----	-------	-------



1-269-8647 96" Rail Only	BLK	103.00	96353
------------------------------------	-----	--------	-------



1-269-8646 Flat Rail Soft Close Add On	BLK	64.40	96352
--	-----	-------	-------

1. For additional components, refer to component section. 2. Items with the price in **bold and red** are Quick Ship items and ship in 24 hours. Please use stock number when ordering. 3. U/M is each unless otherwise noted. 4. Packaged sets and parts bags are available with optional components by special quotation.

How to Order

9458



2D



BLK



For 1-3/8" (35mm) to 1-3/4"(40mm) thick doors standard.

- Non-handed.
- ADA Compliant thumb turn for commercial applications.
- 2-1/4" or 3-1/2" backset options (see specifications for corresponding wall thickness).
- Drive in bolt casing diameter: 1" (25mm).
- Lock bolt: 1/2" (13mm) diameter, stainless Steel material.
- Lock bolt has 1" projection allowing up to 1/2" door to wall gap. Extra spacer ring accommodates up to 3/4" gap between barn door and wall.
- 1-1/4" diameter spring-loaded dust proof strike provides ample space to receive 1/2" bolt, allows easy locking from privacy side. Strike mounted in barn door for standard door.



Description	Finish	2021 List	Stock No.
94582D-32D Round ADA TT Stainless 2-1/4" Backset	32D	182.10	086683
94582D-10B Round ADA TT Oil Rubbed Bronze 2-1/4" Backset	10B	182.10	086672
94582D-BLK Round ADA TT Black 2-1/4" Backset	BLK	182.10	086664
945835-32D Round ADA TT Stainless Steel 3-1/2" Backset	32D	182.10	086663
945835-10B Round ADA TT Oil Rubbed Bronze 3-1/2" Backset	10B	182.10	086657
945835-BLK Round ADA TT Black 3-1/2" Backset	BLK	182.10	086653



Description	Finish	2021 List	Stock No.
9459-32D Surface Jamb Barn Door Lock ADA 1-9/16" Thumb Lever	32D	193.15	35624
9459-BLK Surface Jamb Barn Door Lock ADA 1-9/16" Thumb Lever	BLK	193.15	35617





H **HAGER**[®]
COMPANIES

100	12	1723	65
252	12	1728	66
253	12	1729	66
263	12	1850	66
265	12	1850 LP	66
305	12	AB700	17
417	12	AB700 - Continued.	18
430	12	AB7001	68
451	12	AB7002	69
452	12	AB750	20
453	12	AB750 - Continued.	21
454	12	AB7501	69
455	13	AB7502	69
456	13	AB7505	69
457	13	AB7506	70
458	13	AB7507	70
495	13	AB7508	70
496	13	AB7509	70
497	13	AB800	24
500	14	AB850	26
510	14	AB850 - Continued.	27
511	14	AB8505	71
512	14	AB8506	71
550	14	AB8507	71
551	14	AB8508	72
610	14	AB8509	72
611	14	AB920	29
612	14	AB923	30
615	15	BB1109	31
700	15	BB1129	32
700 - Continued.	16	BB1168	33
800	23	BB1168 - Continued.	34
920	29	BB1168 Drop Leaf	78
990	31	BB1168 Short Leaf	78
992	31	BB1168 Unequal Leaf Centered	79
1129	32	BB1173	38
1150	32	BB1191	41
1173	36	BB1191 - Continued.	42
1191	39	BB1191 - Continued 2	43
1191 - Continued.	40	BB1191 Drop Leaf	78
1250	50	BB1191 Short Leaf	78
1251	50	BB1191 Unequal Leaf Centered	79
1251 - Continued.	51	BB1195	47
1252	51	BB1196	47
1253	51	BB1197	47
1255	52	BB1199	48
1256	52	BB1199 - Continued.	49
1257	52	BB1199 Drop Leaf	78
1260	53	BB1199 Short Leaf	79
1260 - Continued.	54	BB1199 Unequal Leaf Centered	79
1267	55	BB1260	55
1279	56	BB1261	55
1279 - Continued.	57	BB1262	55
1279 - Continued 2	58	BB1263	55
1303	64	BB1266	56
1712	65	BB1277	56
1713	65	BB1278	57
1716	65	BB1279	60
1717	65	BB1279 - Continued.	61
1722	65	BB1279 - Continued 2	62



BB1279 Drop Leaf	78
BB1279 Short Leaf	78
BB1279 Unequal Leaf Centered	79
BB1360	67
BB1361	67
BB1362	67
BB1363	67
BB1577	68
BB1578	68
BB2113	70
BB2168	70
BB2169	71
BB2171	71
CB1191	43
EC1100	75
EC1100 NRP	75
EC1101	76
EC1105	77
ECBB1100	75
ECBB1100 NRP	75
ECBB1101	76
ECBB1101 NRP	76
ECBB1102	76
ECBB1102 NRP	76
ECBB1103	77
ECBB1103 NRP	77
ECRC1100	76
ECRCBB1100	76
IHTAB750	22
IHTAB850	28
IHTHB953	31
WT1191	44
WT1191 - Continued.	45
WT1279	63
WT1279 - Continued.	64
WTAB700	19
WTAB700 - Continued.	20
WTAB750	21
WTAB750 - Continued.	22
WTAB800	25
WTAB800 - Continued.	26
WTAB850	27
WTAB850 - Continued.	28
WTBB1168	35
WTBB1168 - Continued.	36
WTBB1191	45
WTBB1191 - Continued.	46
WTBB1191 - Continued 2	47
WTBB1199	50
WTBB1199 - Continued.	51
WTBB1279	65
WTBB1279 - Continued.	66

1340 4
1541 4
1543 5
1700 18
1710 19
1720 19
1734 6
1741 6
1744 9
1750 9
1751 10
1752 10
1754 11
1760 11
1761 11
1762 11
1764 11
1816 12
1817 12
1818 12
1819 13
1848 16
2617 16
2817 17
7741 17
8741 18
8744 18
8746 18
BB1541 4
BB1543 5
BB1741 6
BB1816 12
BB1817 12
RC1541 4
RC1542 5
RC1641 3
RC1741 7
RC1741 8
RC1748 9
RC1749 9
RC1841 13
RC1842 14
RC1843 15
RC1843 15
RC1846 15
RC1846 15
RC1847 15
RC1847 16
RCBB1541 4
RCBB1542 5
RCBB1741 8
RCBB1842 14



500-048.....	16
500-200.....	16
500-220.....	16
750-134.....	16
750-138.....	16
780-041HD.....	17
780-041LL.....	17
780-045HD.....	17
780-046HD.....	18
780-053.....	18
780-053HD.....	18
780-054HD.....	19
780-057HD.....	19
780-110HD.....	19
780-111.....	20
780-111HD.....	20
780-111LL.....	20
780-112.....	21
780-112HD.....	21
780-112LL.....	21
780-113HD.....	22
780-114HD.....	22
780-124HD.....	22
780-124LL.....	22
780-155HD.....	23
780-157.....	23
780-157HD.....	24
780-210.....	24
780-210HD.....	25
780-211HD.....	25
780-213HD.....	25
780-224.....	26
780-224HD.....	26
780-224LL.....	26
780-226HD.....	27
780-226LL.....	27
780-235HD.....	27
780-257HD.....	28
780-300HD.....	28
1200-600XHD.....	29
1200-650XHD.....	29



790-900.....	6
790-903.....	6
790-904.....	6
790-905.....	6
790-906.....	6
790-909.....	7
790-911.....	7
790-915.....	7
790-926.....	7



45BE	13	4916	48
45CE	15	4917	44
45DT	17	4918	44
45MB	14	4919	45
45MC	16	4920	22
45MD	18	4920	35
45MN	20	4920F	35
45NL	19	4920F	22
45PD	21	4921	22
45PN	21	4923	23
45PT	21	4923F	23
46BE	32	4924	23
46CE	32	4924F	23
46DT	33	4925R	35
46NK	34	4926	23
46NL	34	4927	23
47BE	39	4928	24
47BT	43	4929	24
47CE	40	4929C	24
47DT	40	4930R	24
47KD	41	4930S	24
47KE	42	4931R	45
47KN	42	4931S	45
47KP	43	4932C	24
47NL	41	4932R	25
47PD	43	4932S	25
47PN	43	4933R	45
47PT	43	4933S	45
47RD	44	4934	45
47RN	44	4934F	45
313LE (313LF w/Plastisol)	22	4936	25
313SE (313SF w/Plastisol)	21	4936	45
3901	49	4937	25
3902	50	4937	45
4501 CLB	12	4940	25
4501 CVR	11	4941R	36
4501 D	13	4945	26
4501 M	12	4945F	26
4501 N	13	4950	36
4501 RIM	9	4951	36
4501 SVR	10	4952	36
4501 SVR LBR	9	4953	48
4601 RIM	30	4953	49
4701 RIM	39	4960R	36
4701 SVR	39	4965R	37
4900T	49	2-647-0012	51
4900U	48	2-647-0013	51
4902	49	2-647-0014	51
4904	48	2-647-0015	51
4905	48	2-649-0010	46
4907	49	2-649-0011	46
4910	44	2-649-0012	46
4911	44	2-649-0013	46
4912	48	2-649-0014	46
4912	49	2-649-0021	46
4913	44	2-649-0022	46
4914	44	2-649-0023	46
4915	44	2-649-0024	46
4915	22	2-649-0025	46
4916	45	2-649-0026	46



2-649-0027	46	2-649-0141	47
2-649-0028	46	2-649-0142	47
2-649-0031	26	2-649-0144	47
2-649-0032	26	2-649-0145	47
2-649-0033	26	2-649-0146	47
2-649-0034	26	2-649-0147	47
2-649-0035	26	2-649-0164	47
2-649-0036	26	2-649-0166	28
2-649-0037	26	2-649-0167	28
2-649-0038	26	2-649-0168	28
2-649-0039	26	2-649-0168	37
2-649-0040	26	2-649-0177	28
2-649-0041	26	2-649-0177	47
2-649-0042	26	2-649-0178	28
2-649-0043	26	2-649-0179	28
2-649-0044	26	2-649-0180	28
2-649-0045	50	2-649-0181	28
2-649-0046	50	2-649-0182	28
2-649-0047	50	2-649-0183	28
2-649-0048	50	2-649-0183	47
2-649-0049	27	2-649-0184	47
2-649-0050	50	2-649-0185	47
2-649-0051	50	2-649-0214	26
2-649-0052	50	2-649-0214	37
2-649-0053	50	2-649-0215	26
2-649-0054	50	2-649-0215	37
2-649-0055	47	2-649-0216	26
2-649-0056	50	2-649-0216	37
2-649-0057	50	2-649-0217	26
2-649-0058	51	2-649-0217	37
2-649-0059	51	2-649-0218	26
2-649-0060	27	2-649-0218	37
2-649-0061	27	2-649-0219	27
2-649-0062	27	2-649-0219	37
2-649-0063	27	2-649-0220	26
2-649-0064	27	2-649-0220	37
2-649-0065	27	2-649-0580	38
2-649-0066	27	2-649-0581	38
2-649-0074	27	2-649-0582	38
2-649-0075	27	2-649-0583	38
2-649-0076	27	2-649-0584	38
2-649-0077	27	2-649-0585	38
2-649-0078	27	2-649-0586	38
2-649-0079	27	2-649-0587	38
2-649-0080	27	2-649-0589	38
2-649-0081	27	2-649-0590	38
2-649-0082	28	2-649-0596	38
2-649-0083	28	2-649-0597	38
2-649-0084	28	2-649-0598	38
2-649-0085	28	2-649-1074	29
2-649-0086	28	2-649-1074	37
2-649-0087	28	2-649-1090	29
2-649-0088	28	2-649-1090	37
2-649-0095	46	2-649-1108	29
2-649-0096	46	2-649-1109	29
2-649-0097	46	2-649-4703	47
2-649-0098	46		
2-649-0099	46		
2-649-0100	46		
2-649-0101	46		
2-649-0102	46		
2-649-0103	47		
2-649-0137	50		



2310	5	3810E	45
2317	5	3810S	43
2327	5	3817E	45
2340	5	3817S	43
2510	8	3827E	45
2517	8	3827S	43
2525	8	3830S	49
2527	8	3831S	49
2540	8	3832S*	49
2550	8	3833S	49
2553	8	3834S	49
2570	8	3840E	46
2580	8	3840S	44
2903	24	3844E	46
2903	47	3844S	44
2904	24	3850E	46
2904	47	3850S	44
2908	24	3853E	46
2908	47	3853S	44
2909	24	3856E	46
2909	47	3856S	44
3114	12	3857E*	46
3115	12	3857S*	44
3118	12	3860S	48
3214	16	3861E*	46
3215	16	3861S*	44
3216	16	3862S*	48
3220	16	3863S	48
3221	16	3864S	48
3222	16	3870E	44
3410	22	3870S	42
3417	22	3880E	44
3440	22	3880S	44
3450	23	3881E	46
3453	23	3881S	44
3470	23	3882E*	46
3473	23	3882EL	47
3480	23	3882S*	44
3480ELEU	24	3896E	46
3495	23	3896S	44
3510	30	3901	58
3517	30	3901	62
3525	30	3901	64
3527	30	3902	59
3540	31	3902	62
3550	31	3902	64
3553	31	3903	58
3570	31	3904	59
3573	31	3905	59
3579	31	3907	57
3580	31	3907	61
3610	36	3908	57
3617	36	3908	60
3640	36	3908	61
3653	36	3911	11
3670	36	3911	27
3680	36	3911	65
3710	39	3912	35
3753	39	3912	65
3796	39	3914	37



3915	37	3947	32
3916	25	3947	40
3917	9	3948	9
3917	33	3948	32
3918	51	3948	40
3919-C	63	3949	9
3919-Z	63	3949	32
3920	40	3949	40
3921	40	3950	9
3922	9	3950	32
3922	34	3950	40
3923	9	3951	37
3923	34	3952	37
3924	10	3953	37
3924	34	3954	37
3925	9	3955	56
3925	34	3956	56
3926	10	3956	63
3926	34	3958	10
3927	10	3958	26
3927	34	3958	34
3928	51	3958	38
3929	13	3958	41
3929	17	3959	6
3930	13	3959	9
3930	17	3959	17
3930	40	3959	33
3932	25	3959	38
3932	29	3959	40
3933	6	3959	65
3933	10	3960 or 3906 (Hager Keyway Only)	57
3933	29	3961	56
3933	34	3962	57
3933	38	3962	63
3933	41	3964	24
3934	10	3965	9
3934	26	3965	32
3934	34	3966	25
3934	38	3967	9
3934	41	3967	32
3935	6	3968	65
3935	10	3968	65
3935	26	3971	59
3935	29	3972	59
3935	34	3973	59
3936	25	3974	59
3937	9	3975	60
3937	33	3976	60
3938	37	3977	60
3939	37	3978	60
3940	13	3979	65
3940	17	3980	66
3941	13	3981-BLU or RED (Best A)	60
3941	17	3981-C	60
3942	17	3981-U	60
3943	24	3982-BLU or RED (Best A)	60
3944	25	3982-C or 3969 (Hager SFIC Only)	60
3945	24	3982-U or 3909 (Hager SFIC Only)	60
3946	25	3983	61
3947	9	3984	60



3984 58
 3985 51
 3986 51
 3987 51
 3988 51
 3989 51
 3990 51
 3991 51
 3992 25
 3993 25
 3994 32
 3995 33
 3996 34
 3997 34
 3998 56
 3998 60
 3999 52
 2-300-0001 14
 2-300-0002 14
 2-300-0003 14
 2-300-0004 14
 2-300-0005 14
 2-300-0006 14
 2-300-0007 14
 2-300-0008 14
 2-300-0009 14
 2-300-0010 14
 2-300-0011 14
 2-300-0018 18
 2-300-0019 18
 2-300-0020 18
 2-300-0021 18
 2-300-0022 18
 2-300-0023 18
 2-300-0024 18
 2-300-0025 18
 2-300-0026 18
 2-300-0027 18
 2-300-0028 18
 2-300-0029 18
 2-300-0036 27
 2-300-0038 27
 2-300-0039 27
 2-300-0041 27
 2-300-0042 27
 2-300-0043 27
 2-300-0044 27
 2-300-0045 27
 2-300-0045 35
 2-300-0048 10
 2-300-0048 35
 2-300-0050 10
 2-300-0050 35
 2-300-0052 10
 2-300-0052 35
 2-300-0058 10
 2-300-0058 35
 2-300-0059 35
 2-300-0060 35
 2-300-0064 38

2-300-0066 38
 2-300-0068 38
 2-300-0074 38
 2-300-0091 7
 2-300-0092 7
 2-300-0093 7
 2-300-0105 18
 2-300-0106 18
 2-300-0107 18
 2-300-0108 18
 2-300-0109 18
 2-300-0110 18
 2-300-0111 18
 2-300-0112 18
 2-300-0113 18
 2-300-0114 18
 2-300-0115 18
 2-300-0116 18
 2-300-0118 59
 2-300-0138 41
 2-300-0140 41
 2-300-0141 41
 2-300-0175 64
 2-639-3109 13
 2-639-3109 17
 2-639-3109 41
 2-639-3151 13
 2-639-3152 14
 2-639-3153 14
 2-639-3154 14
 2-639-3155 14
 2-639-3156 14
 2-639-3157 14
 2-639-3168 13
 2-639-3218 19
 2-639-3219 19
 2-639-3220 19
 2-639-3221 19
 2-639-3222 19
 2-639-3223 19
 2-639-3230 19
 2-639-3231 19
 2-639-3233 19
 2-639-3234 19
 2-639-3235 19
 2-639-3236 19
 2-639-3238 14
 2-639-3238 19
 2-639-3239 14
 2-639-3239 19
 2-639-3490 26
 2-639-3490 29
 2-639-3523 10
 2-639-3523 35
 2-639-3577 10
 2-639-3577 32
 2-639-3703 19
 2-639-3704 19
 2-639-3705 19

2-639-3706.....	19	2-639-7519.....	67
2-639-3707.....	19	2-639-7520.....	67
2-639-3708.....	19	2-639-7522.....	67
2-639-7000.....	57	2-639-7523.....	68
2-639-7001.....	57	2-639-7524.....	68
2-639-7002.....	57	2-639-7526.....	68
2-639-7003.....	57	2-639-7527.....	68
2-639-7005.....	57	2-639-7528.....	68
2-639-7006.....	58	2-639-7530.....	68
2-639-7007.....	58	2-639-7531.....	68
2-639-7008.....	58	2-639-7532.....	68
2-639-7018.....	58	2-639-7534.....	68
2-639-7058.....	59	2-639-7535.....	68
2-639-7060.....	61	2-639-7536.....	68
2-639-7061.....	62	2-639-7536.....	68
2-639-7082.....	62	2-639-7537.....	68
2-639-7083.....	62	2-639-7536.....	65
2-639-7084.....	62	2-639-7570.....	65
2-639-7085.....	63	2-639-7572.....	65
2-639-7086.....	63	2-639-7573.....	65
2-639-7087.....	58	2-639-7574.....	65
2-639-7090.....	62	2-639-7578.....	64
2-639-7091.....	62	2-639-7601.....	7
2-639-7094.....	58	2-639-7603.....	7
2-639-7095.....	62	2-639-7604.....	7
2-639-7143.....	20	2-639-7605.....	7
2-639-7144.....	20	2-639-7606.....	7
2-639-7146.....	13	2-639-7607.....	6
2-639-7147.....	13	2-639-7608.....	6
2-639-7148.....	13	2-639-7609.....	6
2-639-7149.....	13	2-639-7610.....	6
2-639-7150.....	13	2-639-7617.....	6
2-639-7151.....	19	2-639-7619.....	6
2-639-7152.....	19	2-639-7620.....	6
2-639-7153.....	19	2-639-7621.....	6
2-639-7154.....	20	2-639-7622.....	6
2-639-7155.....	20	2-639-7645.....	64
2-639-7156.....	20	2-639-7646.....	64
2-639-7157.....	20	2-639-7647.....	64
2-639-7158.....	20	2-639-7649.....	63
2-639-7159.....	38	2-639-7680.....	66
2-639-7160.....	15	2-647-0012.....	66
2-639-7160.....	20	2-647-0013.....	66
2-639-7161.....	15	2-647-0014.....	66
2-639-7161.....	20	2-647-0015.....	66
2-639-7163.....	15	2-647-0016.....	66
2-639-7163.....	20	2-647-0017.....	66
2-639-7164.....	15	2-647-0018.....	66
2-639-7164.....	20	2-647-0019.....	66
2-639-7165.....	20	2-647-0020.....	66
2-639-7166.....	20	2-649-0045.....	66
2-639-7167.....	15	2-649-0046.....	66
2-639-7167.....	20	2-649-0047.....	66
2-639-7192.....	58	2-649-0048.....	66
2-639-7322.....	58	2-649-0050.....	66
2-639-7511.....	67	2-649-0051.....	66
2-639-7512.....	67	2-649-0052.....	66
2-639-7513.....	67	2-649-0053.....	67
2-639-7517.....	67	2-649-0054.....	67
2-639-7518.....	67		



2-649-0055 67
 2-649-0056 67
 2-649-0057 67
 2-649-0058 67
 2-649-0059 67
 2-649-0137 59
 2-669-0111 53
 2-669-0112 53
 2-669-0115 53
 2-669-0116 54
 2-669-0119 54
 2-669-0120 54
 2-669-0123 54
 2-669-0124 54
 2-669-0127 54
 2-669-0128 54
 2-669-0131 54
 2-669-0132 54
 2-669-0135 54
 2-669-0136 54
 2-669-0139 54
 2-669-0140 54
 2-669-0143 54
 2-669-0144 54
 2-669-0147 54
 2-669-0148 54
 2-669-0157 54
 2-669-0158 54
 2-669-0167 54
 2-669-0168 54
 2-669-0224 52
 2-669-0226 52
 2-669-0230 52
 2-669-0232 52
 2-669-0236 52
 2-669-0238 52
 2-669-0242 52
 2-669-0244 52
 2-669-0248 52
 2-669-0250 52
 2-669-0254 52
 2-669-0256 52
 2-669-0296 52
 2-669-0298 52
 2-669-0302 52
 2-669-0304 52
 2-669-0308 53
 2-669-0310 53
 2-669-0314 53
 2-669-0316 53
 2-669-0320 53
 2-669-0322 53
 2-669-0326 53
 2-669-0328 53
 2-669-0365 53
 2-669-0366 54
 2-669-0389 11
 2-669-0389 26
 2-669-0389 29
 2-669-0389 35

2-669-0389 38
 2-669-0389 52
 2-669-0408 53
 2-669-0410 53
 2-669-0411 53
 2-669-0415 53
 2-669-0417 53
 2-669-0418 53
 2-669-0422 53
 2-669-0424 53
 2-669-0425 53
 2-669-0597 55
 2-669-0600 55
 2-669-0603 55
 2-669-0604 55
 2-669-0605 55
 2-669-0613 55
 2-669-0615 55
 2-669-0616 55
 2-669-0635 55
 2-669-0636 55
 2-669-0641 55
 2-669-0643 55
 DPM 47
 LM 47
 RX 47
 Stainless Mortise Lock Levers (each) 51
 Zinc Mortise Lock Levers (each) 51

380F	24	5905	23
380G	24	5906	13
380H	24	5906	23
380R	24	5907	13
380S	24	5907	19
381A	25	5908	12
381B	25	5908	19
381C	25	5909	8
381D	25	5910	13
381E	25	5910	19
381H	25	5911	13
381S	25	5911	19
381W	26	5912	13
5100 Series	5	5912	19
5101	6	5913	14
5102	6	5913	17
5103	6	5913	23
5104	7	5914	12
5106	7	5914	20
5107	7	5915	20
5108	7	5916	20
5109	7	5917	20
5110	7	5918	14
5111	7	5919	14
5112	7	5920	14
5113	7	5921	14
5114	7	5922	14
5115	8	5923	14
5125	8	5932	14
5200 Series	11	5935	8
5201	12	5936	14
5202	12	5936	20
5203	12	5940	8
5204	12	5941	8
5300 Series	17	5942	8
5301	18	5943	8
5302	18	5946	8
5303	18	5950	8
5304	18	5950	15
5400 Series	22	5950	20
5401	22	5954	9
5402	22	5955	9
5403	22	5956	15
5404	20	5957	15
5900	12	5961	9
5900	16	5962	9
5900	23	6000 Series Accessories	28
5901	11	6000 Series Screwpacks	28
5901	23	6000 Series Screwpacks	28
5902	13	6015 Series - Medium Duty Concealed Mount	27
5902	23	6015 Series - Medium Duty Surface Mount	27
5902	23	6016 Series - Medium Duty Concealed Mount	27
5903	13	6016 Series - Medium Duty Surface Mount	27
5903	16	6017 Series - Medium Duty Concealed Mount	28
5903	23	6017 Series - Medium Duty Surface Mount	28
5904	13	7000 Series Accessories	30
5904	17	7000 Series Accessories	30
5904	23	7000 Series Screwpacks	30
5905	13	7015 Series - Heavy Duty Concealed Mount	29
5905	13	7015 Series - Heavy Duty Surface Mount	29



7016 Series - Heavy Duty Concealed Mount	29
7016 Series - Heavy Duty Surface Mount	29
7017 Series - Heavy Duty Concealed Mount	30
7017 Series - Heavy Duty Surface Mount	30
2-659-0134	9
2-659-0135	9
2-659-0136	9
2-659-0137	9
2-659-0138	15
2-659-0139	9
2-659-0140	9
2-659-0141	15
2-659-0142	9
2-659-0143	9
2-659-0144	9
2-659-0145	9
2-659-0203	9
2-659-0204	9
2-659-0205	10
2-659-0206	10
2-659-0207	10
2-659-0208	10
2-659-0209	10
2-659-0210	10
2-659-0211	15
2-659-0212	16
2-659-0213	16
2-659-0214	16
2-659-0215	16
2-659-0216	16
2-659-0217	16
2-659-0218	16
2-659-0350	15
2-659-0351	15
2-659-0352	15
2-659-0354	15

29KS ADD	3	2-659-0164	18
29KS ASD	3	2-659-0166	18
29KS MDD	3	2-659-0167	18
29KS MSD	3	2-659-0168	18
29EA NS	3	2-659-0169	18
29EA KS	3	2-659-0170	18
29EA MKNC	3	2-659-0171	18
2901	3	2-659-0172	18
2902	3	2-659-0173	19
2903	3	2-659-0174	19
2904	3	2-659-0175	19
2908	3	2-659-0176	19
2909	3	2-659-0177	19
2910	4	2-659-0178	19
2911	4	2-659-0179	19
2915	4	2-659-0180	19
2916	4	2-659-0181	20
2916P	4	2-659-0182	20
2925	5	2-659-0183	20
2928 RC	5	2-659-0184	20
2928 SC	5	2-659-0185	20
2930 CYL	5	2-659-0186	20
2930 MDB	6	2-659-0220	13
2930 MOR	5	2-659-0221	13
2941 Magnetic Lock	6	2-659-0222	13
2942 Magnetic Lock	6	2-659-0223	13
2951 Magnetic Lock	7	2-659-0224	13
2952 Magnetic Lock	7	2-659-0225	13
2953 Magnetic Lock	7	2-659-0226	13
2954 Magnetic Lock	7	2-659-0227	13
2958 Delayed Egress Magnetic Lock	9	2-659-0228	13
2958 T Tandem Delayed Egress Magnetic Lock	9	2-659-0229	13
2961 Magnetic Shear Lock	9	2-659-0230	13
2965 Magnetic Shear Lock	9	2-659-0231	13
2972 Exit Switch	10	2-659-0232	13
2972T Exit Switch with Integrated Adjustable Timer	10	2-659-0233	13
2973 Code Compliant Exit Switch	10	2-659-0234	14
2977 Exit Swtich	10	2-659-0235	14
2978 Touchless Exit Switch	10	2-659-0236	14
4801 Pressure Sense Bar	10	2-659-0237	14
8218 Single Operator	15	2-659-0240	20
8219 Simultaneous Pair Operator	15	2-659-0241	18
8221 Double Egress Simultaneous Pair Operator	15	2-659-0242	19
8418 Single Operator	12	2-659-0243	19
8419 Simultaneous Pair	12	2-659-0275	15
8420 Independent Pair	12	2-659-0276	15
8421 Double Egress Simultaneous Pair	12	2-659-0277	15
8422 Double Egress Independent Pair	12	2-659-0278	15
8423 Single Operator with Mechanical Closer	12	2-659-0279	15
2928 6R	5	2-659-0280	15
2928 7R	5	2-659-0303	17
2-659-0151	13	2-659-0304	17
2-659-0152	13	2-659-0305	17
2-659-0153	13	2-659-0306	17
2-659-0154	13	2-659-0307	17
2-659-0161	17	2-659-0308	17
2-659-0162	17	2-659-0332	20
2-659-0163	17	2-659-0333	20



2-659-0334	20	2-679-0600	9
2-659-0335	20	2-679-0601	9
2-659-0336	20	2-679-0611 PIR Egress Sensor	11
2-659-0368	11	2-679-0612 PIR Egress Sensor	11
2-659-0372	11	2-679-0620	11
2-679-0021	4	2-679-0621	11
2-679-0022	4	2-679-0622	11
2-679-0023	5	2-679-0623	11
2-679-0024	5	2-679-0624	11
2-679-0028	6	2-679-0625	11
2-679-0029	6	2-679-0626	11
2-679-0100	6	2-679-0640	11
2-679-0101	6	2-679-0641	11
2-679-0102	6	2-679-0642	11
2-679-0103	6	2-679-0650	11
2-679-0104	6	2-679-0661	4
2-679-0106	6	2-679-0662	4
2-679-0107	6	2-679-0664	4
2-679-0108	6	2-679-0669	4
2-679-0120	7	2-679-0700	4
2-679-0121	7	2-679-0703	4
2-679-0130	7	2-679-0704	4
2-679-0131	7	2-679-0705	4
2-679-0160	7	2-679-0706	4
2-679-0161	7	2-679-0708	11
2-679-0180	7	2-679-0896	16
2-679-0181	7	2-679-0897	16
2-679-0190	7	2-679-0898	16
2-679-0191	7	2-679-0899	16
2-679-0200	8	2-679-0900	16
2-679-0201	8	2-679-0901	16
2-679-0204	8	2-679-0902	16
2-679-0205	8	2-679-0903	16
2-679-0210	8	2-679-0904	16
2-679-0220	8	2-679-0905	16
2-679-0281	8	2-679-0906	16
2-679-0283	8	2-679-0907	16
2-679-0291	8		
2-679-0293	8		
2-679-0311	8		
2-679-0313	8		
2-679-0321	8		
2-679-0323	8		
2-679-0381	8		
2-679-0383	8		
2-679-0391	8		
2-679-0393	8		
2-679-0411	8		
2-679-0413	8		
2-679-0421	8		
2-679-0423	9		
2-679-0491	9		
2-679-0493	9		
2-679-0501	9		
2-679-0503	9		
2-679-0571	9		
2-679-0573	9		
2-679-0581	9		
2-679-0583	9		

1E	9	22N	24
1G	9	23Q	25
1J	9	24Q	25
1L	9	25B	25
2E	10	25C	25
2G	10	25N	26
2J	10	25P	26
2L	10	26N	26
3E	11	27N	26
3G	11	27P	26
3J	11	30S	27
3L	11	31E	29
4G	12	31G	29
4H	12	31J	30
4J	13	32E	30
4L	13	32G	31
5D	13	32J	31
5N	13	33E	32
6N	14	33G	32
7N	14	33J	33
8N	14	34G	33
9E	15	34J	34
9G	15	35D	34
9J	15	35N	35
9L	15	36N	35
10L	16	39E	36
10Q	16	39G	36
11E	16	39J	37
11G	16	40R	37
11J	17	50T	39
11L	17	60S	40
12G	17	70S	41
12J	17	80S	41
12L	18	90R	42
13E	18	100T	43
13G	18	110S	45
13J	18	120L	45
13L	19	121L	45
14G	19	122L	45
14H	19	125S	46
14J	19	126S	46
14L	20	127S	46
15C	20	128P	46
15N	20	128S	47
15P	20	129P	47
15S	21	130S	47
16N	21	131S	47
16R	21	133S	48
17N	21	134S	48
19N	22	136S	48
20L	22	137S	48
20N	22	138P	49
20Q	22	139P	49
21E	23	140P	49
21G	23	150B	49
21J	23	150D	50
21L	23	150V	50
22G	24	151B	50
22J	24	151D	50
22L	24	151V	51



152B	51	199B	7
152D	51	204S	7
152V	51	208	131
153B	52	209	131
153D	52	210	131
153V	52	211	132
154B	52	212	132
154D	53	214S	7
154V	53	220S	7
155B	53	225S	8
155D	53	230W	68
155V	54	232W	69
156B	54	234W	69
156D	54	236W	69
156V	54	241F	70
157B	55	242F	70
157D	55	243F	70
157V	55	244F	70
158B	55	245F	71
158D	56	246B	71
158V	56	248F	71
159B	56	248G	71
159D	56	249F	71
159V	57	250W	72
160B	57	251W	72
160D	57	252F	72
160V	57	254S	72
161B	58	254W	72
161D	58	255S	73
161V	58	255W	73
164B	58	256S	73
164D	59	256W	73
164V	59	257F	73
165B	59	258F	74
165D	59	259F	74
165V	60	259H	74
167B	60	260W	74
167D	60	267F	74
167V	60	267S	75
170D	61	268F	75
180H	61	268S	75
180K	61	269F	75
180M	62	269T	76
180P	62	270C	76
180Q	63	270D	76
181H	63	270R	76
181K	64	271D	76
181M	64	271W	77
181P	65	272W	77
181Q	65	273W	77
182H	66	274B	77
182K	66	274C	77
182M	67	274D	77
182P	67	275D	78
182Q	68	276D	78
185G	68	277D	78
190F	25	277F	78
190S	7	277R	78
198S	7	278D	79

279D	79	337B	91
280X	79	337C	91
281D	79	337D	91
282D	80	340D	92
283D	80	341C	92
291D	80	341D	92
292D	81	342D	92
293D	81	345D	92
294D	81	350H	93
295M	82	350L	93
295W	82	350M	93
296W	82	350R	94
297C	82	350W	93
297D	83	351H	94
297F	83	351L	94
297B	83	352M	94
298D	83	352W	95
300D	84	354A	95
301D	84	354B	95
303W	84	364L	96
305D	84	364M	96
307D	85	364N	96
308D	85	364S	96
310C	85	365M	97
311H	85	365W	97
313S	85	366R	97
318D	86	366S	97
318S	86	368E	98
320R	86	368M	98
321R	86	368U	99
322V	86	368W	98
323S	87	369L	99
324W	87	369R	99
326F	87	370M	99
326W	87	370U	100
327F	88	370W	100
327W	88	901P	101
328F	88	902P	101
329F	89	903P	101
330D	89	910B	103
330L	89	910P	102
330M	89	915B	103
334V	90	915P	103
336A	90	920B	104
336B	90	920P	104
336C	90	921B	105
336D	90	921P	105
336E	90	922B	106
336F	90	922P	105
336G	90	923B	107
336H	90	923P	106
336J	90	924B	107
336K	91	924P	107
336L	91	925B	109
336M	91	925P	108
336N	91	926B	109
336P	91	926P	109
336Q	91	930B	110
336R	91	930P	100
337A	91		



932P	110	1447	134
933B	111	1448	134
933P	111	1449	134
934B	112	1755	135
934P	111	1756	135
936P	112	1758	135
937P	112	1759	135
940P	113	1765	135
941P	113	1766	135
945P	113	2610	129
946P	113	2620	129
951P	113	2630	129
952P	114	2640	129
956P	114	6601	136
957P	114	9558	130
960B	114	9566	130
960P	114	9567	130
961B	115	9865	130
961P	115	9882	130
962P	115	9884	130
963P	116	A30S	28
967P	116	A40R	38
970P	117	A50T	40
974B	118	BL6209	136
974P	117	BL6211	136
975B	119	BL6212	136
975P	119	BL6610	136
976B	120	BL6793	136
976P	120	BL6794	136
980B	121	CSK	8
980P	120	P4E	12
981B	123	P8N	14
981P	122	SA	8
982B	123	T4E	12
982P	123		
983B	124		
983P	124		
984B	125		
984P	125		
985B	126		
985P	125		
986B	126		
986P	126		
987B	126		
987P	126		
988B	127		
988P	127		
990B	128		
990P	127		
1412	132		
1413	132		
1414	133		
1415	133		
1416	133		
1418	133		
1419	133		
1439	134		
1442	128		
1443	128		
1446	134		

401S 6
402S 6
403S 6
404S 6
406S 6
407S 6
408S 6
410S 6
412S 7
413S 7
415S 7
416S 7
417S 7
418S 7
419S 7
420S 7
421S 7
422S 8
423S 8
424S 8
426S 8
427S 8
428S 8
430S 8
431S 9
432S 9
433S 9
434S 9
435S 9
436S 9
438S 9
440S 9
442S 9
443S 10
444S 10
445S 10
448S 10
450S 10
451S 10
452S 10
455S 10
460S 10
465S 10
470S 11
477S 11
478S 11
481S 11
484S 11
492S 11
503S 11
504S 11
505S 11
506S 12
508S 12
516S 12
517S 12
518S 12
520S 12
532S 12
541S 12

552S 12
560S 12
572S 13
575S 13
580S 13
599S 13
600S 13
604S 13
626S 13
627S 14
651S 14
652S 14
676S 14
677S 14
701S 15
709S 15
710S 15
717S 15
718S 15
719 15
720 15
721 16
722 16
724 16
725 16
726 16
727 17
728 17
729 17
730S 17
734 17
736 18
737 18
738 18
739 18
740S 19
742S 19
743S 19
747S 19
750S 18
751S 20
752S 20
753S 20
754S 20
756S 20
759S 20
770S 21
771S 21
774S 21
776S 21
777S 21
778S 21
779S 22
780S 22
782S 22
783S 22
785S 22
787S 22
789S 22



800S	22
801S	23
802S	23
803S	23
806S	23
808S	23
810S	24
835S	24
836S	24
837S	24
838S	24
845S	25
846S	25
847S	25
848S	25
849S	25
859S	25
860S	25
861S	26
862S	26
863S	26
864S	26
865S	26
866S	26
870S	26
871S	26
872S	26
873S	27
874S	27
875S	27
877S	27
878S	27
880S	27
881S	27
882S	27
883S	27
884S	28
885S	28
890S	28
891S	28
892S	28
893S	28
896S	28
900S	29
901S	29
902S	29
903S	29
904S	29
905S	29
906S	29
907S	30
908S	30
900S	30

330D	27	9354	30
330L	27	9400	5
330M	27	9400	13
1741	27	9400	30
2610	5	9401	5
2610	8	9401	9
2610	13	9401	13
2610	27	9401	30
2620	27	9436-78.....	38
2630	8	9514-48.....	5
2630	13	9540	8
2630	28	9540	13
2640	28	9540	30
9101-60.....	4	9544	8
9101-60.....	26	9544	13
9101-72.....	4	9544	30
9102	4	9558	17
9102	20	9558	30
9102	4	9559	17
9105	4	9559	18
9105	20	9559	30
9105	28	9566	30
9109	4	9567	31
9109	20	9569	17
9109	28	9569	31
9110-60.....	4	9570-36.....	17
9110-60.....	20	9572	10
9111	28	9572	11
9113	28	9572	17
9114-72.....	28	9572	31
9115	4	9573	7
9115	20	9573	31
9115	20	9574	15
9115	28	9574	31
9121	29	9575	10
9122-48.....	29	9575	11
9128	29	9575	31
9129	4	9583-96.....	5
9129	20	9601-35.....	17
9129	29	9601-71.....	20
9130-60.....	4	9601-71.....	21
9130-60.....	20	9601-71.....	31
9169	29	9602-46.....	11
9200	29	9602-46.....	31
9201	29	9602-58.....	11
9202	9	9603-48.....	10
9202	13	9603-48.....	32
9202	29	9605	10
9203	29	9605	11
9220	17	9605	22
9220	29	9605	32
9262	29	9606	10
9264	29	9606	12
9268	30	9606	21
9351	5	9606	22
9351	9	9606	32
9351	13	9610	32
9351	30	9611-60.....	7
9353	5	9614-48.....	8
9353	30	9618	17



9618	32	9824	7
9628	21	9824	35
9629	21	9825	7
9630	21	9825	18
9631	21	9825	25
9632	22	9825	35
9632	32	9827	15
9633	22	9827	16
9633	32	9827	19
9634	32	9827	23
9639	32	9827	24
9673-48	10	9827	26
9674-48	10	9827	35
9675-48	11	9828	18
9676-48	11	9828	19
9678-72	22	9828	35
9679	10	9841	5
9679	11	9841	8
9679	32	9841	13
9680	10	9841	35
9680	11	9842	8
9680	32	9842	13
9683-96	8	9842	35
9703-60	26	9843	8
9703-60	33	9843	13
9704-60	26	9843	35
9704-60	33	9844-48	13
9705	26	9845-96	13
9705	33	9850	23
9709-48	7	9860-30	18
9709-48	11	9861-48	18
9709-60	33	9865	6
9710-60	26	9865	9
9711	26	9865	14
9711	33	9865	36
9742	24	9875-48	15
9742	33	9877	36
9801-48	19	9878-72	24
9801-72	15	9880	36
9801-72	23	9881	21
9801-72	24	9881	22
9801-72	33	9881	23
9803-48	14	9881	24
9809-72	15	9881	25
9809-72	34	9881	36
9810-46	5	9882	36
9810-46	34	9883	21
9814	5	9883	21
9814	34	9883	22
9815	16	9883	23
9815	17	9883	24
9815	18	9883	36
9815	26	9884	36
9815	34	9885-48	16
9820-48	8	9886-96	16
9820-48	35	9889	36
9821-59	7	9890-30	19
9821-59	18	9892	7
9821-59	25	9892	37
9821-59	34	9893	7

9893 37
9894 18
9894 37
9895 25
9895 37
9900 37
9901-72 25
9909 7
9909 10
9909 12
9909 15
9909 16
9909 37
1-269-8663 39
1-269-8664 39
1-269-8665 39
1-269-8666 39
1-269-8667 39
1-269-8668 39
1-269-8669 39
1-269-8670 39
1-269-8671 39
1-269-8672 39
1-269-8673 39
1-269-8674 39
1-269-8675 39
1-269-8676 40
1-269-8677 40
1-269-8678 40
1-269-8679 40
1-269-8680 40
9456-72 41
9456-96 41
9457-72 41
9457-96 41
1-269-8649 41
1-269-8648 41
1-269-8647 41
1-269-8646 41
94582D-32D 42
94582D-10B 42
94582D-BLK 42
945835-32D 42
945835-10B 42
945835-BLK 42
9459-32D 42
9459-BLK 42

