



SCHLAGE

L Series

Commercial mortise locks





Contents

4-5	Mechanical lock guide
7	L Series introduction and performance features
8-9	Schlage L9000 and L400 Series
10	M Collection levers
12	Standard Collection levers
14	Escutcheons and roses
15	Thumbturns
16	Lock components
17	Lock functions - ANSI A156.13, Series 1000
18	Lock functions - single cylinder non-deadbolt
19	Lock functions - single cylinder deadbolt
20	Lock functions - double cylinder non-deadbolt and deadbolt
21	Lock functions - full mortise and small mortise deadlocks
22	L Series universal transformation instructions
24	Electrified lock function
25	Cylinder types
26	Standard (non-IC) cylinders
27	Full-size interchangeable core (FSIC) cylinders
28	Small format interchangeable core (SFIC) cylinders
29	Blocking and compression rings
30	Classroom thumbturn cylinders
31	Armored fronts
32	Strikes
33	Door handing
34	Specifications and certifications
35	How to order

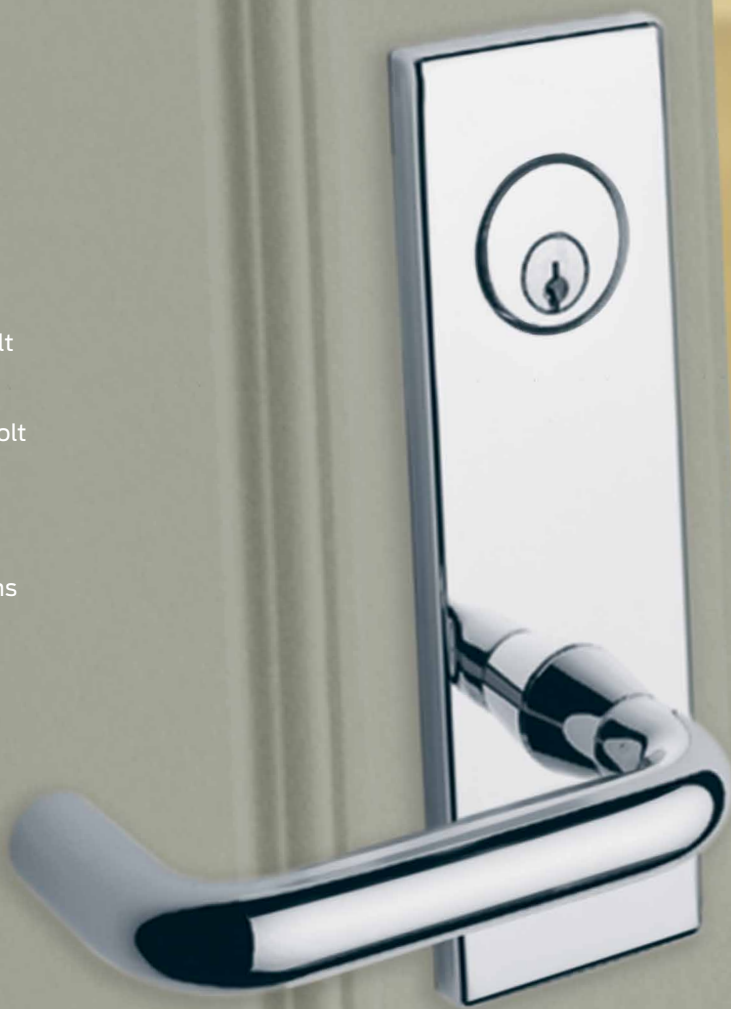

Put your trust in the name you know

For more than 90 years, Schlage® has been creating the strongest and most technologically advanced security products for schools, hospitals, hotels, commercial and institutional buildings, multi-family properties and homes. From durable mechanical locks to comprehensive electronic access control solutions and biometrics, Schlage provides protection at critical moments – when property and personal security are at stake. With a wide range of products, styles and finishes, Schlage has products for the most demanding project specifications. In public buildings, in the workplace, and in homes, at the end of the day Schlage stands for one thing: strong.



Tubular interconnected locks



Tubular locks



Tubular interconnected locks







Cylindrical locks



Cylindrical interconnected locks

CS200 Series	S Series	S200 Series	A Series	H Series
Grade 2	Grade 2		Grade 2	
Security level:				
ANSI/BHMA certified A156.12-2013 Exceeds 400,000 ANSI cycles Medium traffic	ANSI/BHMA certified A156.2-2011 Exceeds 400,000 ANSI cycles Light traffic	- - Exceeds 400,000 ANSI cycles Medium traffic	ANSI/BHMA certified A156.2-2011 Exceeds 400,000 ANSI cycles Medium traffic	- - Exceeds 400,000 ANSI cycles Medium traffic
Typical applications:				
Exterior Interior New construction Retrofit	- Interior - Retrofit	Exterior Interior New construction Retrofit	Exterior Interior New construction Retrofit	Exterior Interior - Retrofit
Functions available:				
1 Function - -	6 Functions - -	5 Functions - -	11 Functions - -	5 Functions - -
Design options:				
7 Finishes 15 Lever styles - 1 Matching rose 2 Interior escutcheons Tactile warning available	7 Finishes 4 Lever styles - 1 Matching rose - Tactile warning available	7 Finishes 4 Lever styles - 1 Matching rose 1 Interior escutcheon -	10 Finishes 1 Lever style 4 Knob styles 1 Matching rose - -	7 Finishes 1 Lever style 2 Knob styles 1 Matching rose 1 Interior escutcheon -
Often used in:				
Commercial Multi-family Office	Commercial Multi-family Office	Commercial Multi-family Office	Commercial Govt/military Healthcare Hospitality Office Retail	Commercial Govt/military Multi-family

Not all functions and finishes available with all products. Please consult your SSC representative for details.

				
Cylindrical locks	Deadbolts	Cylindrical locks	Cylindrical locks	Mortise locks
AL Series	B Series	D Series	ND Series	L Series
Grade 2	Grade 2	Grade 1	Grade 1	Grade 1
Security level:				
ANSI/BHMA certified A156.2-2011 Exceeds 400,000 ANSI cycles Medium traffic	ANSI/BHMA certified A156.36-2010 Exceeds 150,000/250,000 ANSI cycles High traffic, heavy-duty	ANSI/BHMA certified A156.2-2011 Exceeds 1,000,000 ANSI cycles High traffic	ANSI/BHMA certified A156.2-2011 Exceeds 1,000,000 ANSI cycles Heavy-duty traffic	ANSI/BHMA certified A156.13-2012 Exceeds 1,000,000 ANSI cycles Heavy-duty traffic
Typical applications:				
Exterior Interior New construction Retrofit	Exterior - New construction Retrofit	Exterior Interior - Retrofit	Exterior Interior New construction Retrofit	Exterior Interior New construction Retrofit
Functions available:				
10 Functions - -	7 Functions - -	6 Functions - -	14 Functions 2 Electrified -	29 Functions 6 Electrified Vandlgard® available
Design options:				
10 Finishes 4 Lever styles - 1 Matching rose - Tactile warning available	10 Finishes - - - - Indicator rose	10 Finishes - 3 Knob styles 1 Matching rose - -	9 Finishes 5 Lever styles - 2 Matching roses - Tactile warning available	13 Finishes 32 Lever style 3 Knob styles 5 Matching roses 2 Escutcheons Tactile warning available Antiligature available
Often used in:				
Commercial Healthcare Hospitality Office Retail	Commercial/institutional Govt/military Heavy-duty residential Hospitality Office Retail	Institutional Govt/military Hospitality Retail	Institutional Education Healthcare Office Retail	Commercial/institutional Govt/military Education Healthcare Office Retail

This chart shows the most common uses/applications. These products are often used in other applications in addition to those listed.

Rev. 04/14



Real security is knowing exactly what you want and getting it

When you know exactly what you want, you don't want to waste time finding out whether it meets your project specifications. That's why we offer the world's largest team of hardware specification writers to help you and your clients turn your vision into reality. And when it comes to products, our commercial suiting options, wide variety of lever designs and rich selection of finishes give you the tools you need to make your projects perfect. You know what you want. With Schlage you can be sure you'll get it.

Safety, security and confidence

When you choose a Schlage lock you can be sure you've done the job right the first time. After all, our products are among the most durable and dependable on the market today. Our locks are easy to install, and simple to repair and maintain. That means fewer callbacks for you and total safety and security for your customers.



L Series

Nothing is tougher

At Schlage we know that every product you specify has to stand up to constant use and abuse. Your building's locking systems face an additional challenge – keeping people and other assets safe while delivering constant, reliable performance. Schlage L Series Extra Heavy Duty Mortise Locks are built to withstand the rigors of daily use without fail.



We don't compromise on security

The safety and security of your clients' buildings is something we take very seriously. That's why every Schlage lock and deadbolt undergoes intensive testing to determine its ANSI grade level:

- Cycle tests
- Resistance tests
- Door impact tests
- Warped door tests
- Bolt strength tests

We pay attention to these details so you can focus on creating a functional and aesthetically pleasing environment for your clients. In fact, every one of our L Series locks meets ANSI Grade 1 standards for safety.

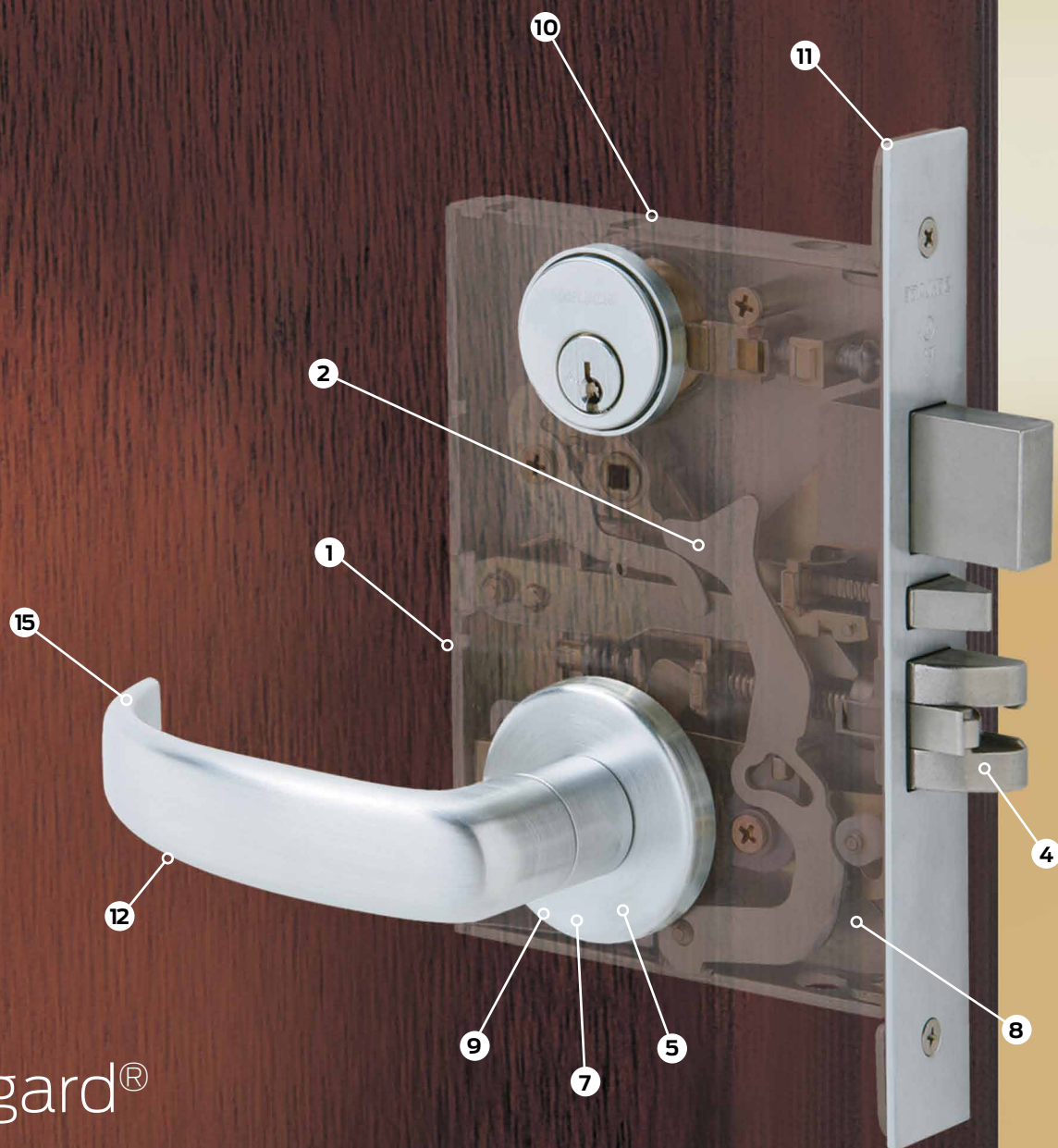

Vandlgard®

The L Series Vandlgard is ideal for areas subject to abuse or anywhere vandalism is likely to be present. Vandlgard prevents damage to internal lock components caused by excessive force from kicking, hitting or standing on the lever to gain access.

It's easy to retrofit standard L Series locks with Vandlgard using the Vandlgard Retrofit Kit and an instructional DVD that shows installation on existing hardware.

The right lock for every application

Schlage L9000 Series

Our L9000 Series locks are ideal for use in schools, hospitals and factories, where the finest hardware must also deliver consistent, dependable operation and stand up to constant use and abuse.

Strength and durability

1. Fully wrapped heavy-gauge steel case protects against door edge attacks
2. All-metal zinc dichromate-plated working parts
3. Inside lock case protects electronic components
4. Two-piece anti-friction tongue reduces wear and tear
5. Outside and inside trim thru-bolted together and through the door

Security built in

6. Break-away spindle prevents unsecured failures and provides easy spindle replacement
7. Hub blocking plate protects lock against spindle manipulation
8. Spring-loaded fusible link provides fail secure mode in case of fire
9. Inside lever applied by screwless shank mounting – no exposed trim mount screws

Adaptable to your application

10. Universal lock case – ten functions in one case
11. Floating mounting tabs automatically adjust to fit a beveled door edge
12. Field-reversible handing without opening lock case
13. External spring cages allow for simple trim retrofit
14. Locking thumbturn on the inside of door visually shows when the door is locked and unlocked
15. Lever rotation in both directions (up and down) for ease of use
16. Independent lever rotation

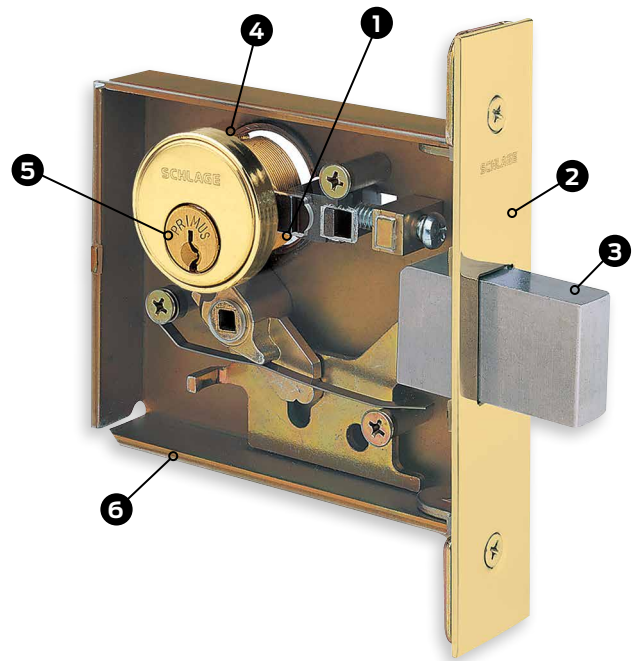

Schlage L400 Series

Our L400 Series locks are designed for use as primary locks where no latching is required, such as restrooms and small doors to utility spaces. They also offer optimum security when used as auxiliary locks in other applications.

1. High-strength steel alloy cylinder retainer
2. Armored front in brass, bronze or stainless steel; adjustable for door bevel
3. 1" (25 mm) stainless steel throw deadbolt
4. Deeper retainer groove in cylinder shell increases security against wrenching and pullout; all cylinders backward compatible
5. 6-pin Everest® cylinder with patented keys standard
6. Steel case and parts are corrosion resistant

The M Collection

A range of options. A single standard of quality.

Introducing the M Collection, an entire lineup of decorative levers designed to maintain a custom high-style look on doors throughout any building—from the main entrance to the supply closet.

The ability to suite M Collection levers across multiple platforms from Schlage and Von Duprin means consistent style and functionality—along with unrivaled security.

The M Collection was designed to function as a visual extension of any interior, from contemporary to classic.

M51

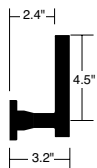

M52

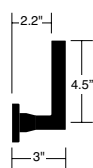

M53



M56

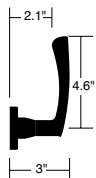

M57

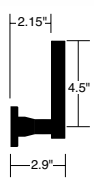

M61

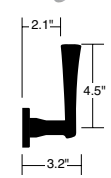

M81

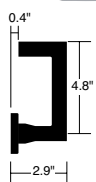

M82



M83

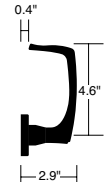

Finish options									
Color	Bright brass	Satin brass	Antique brass	Satin nickel	Bright chrome	Satin chrome	Bright stainless steel	Satin stainless steel	Aged bronze
ANSI/BHMA number	605	606	609	619	625	626/626AM	629	630/630AM	643
US number	US3	US4	US5	US15	US26	US26D	US32	US32D	US11

AM = Antimicrobial.

See pricebook for additional trim and finish availability. 33A, 95 & 99 devices not available in 619 & 630 finishes.

M54

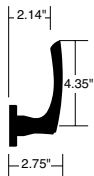

M55

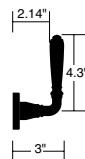

M62

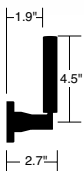

M63



M84

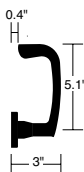

M85



All lever designs shown (M Collection and Standard) can be paired with any of the following commercial graded products for suiting across an office, a floor or an entire building.

Locks



Schlage L Series mortise locks Grade 1

Schlage L Series locks have long been the industry standard for mortise locks, with a comprehensive offering of functions and options to support any opening need.



Schlage LT Series tubular locks Grade 2

The perfect compliment to the Schlage L Series or the Von Duprin exit devices, the LT Series tubular chassis is based on venerable L Series mortise lock and provides an alternative to lever suiting for interior doors.

Exit devices



Von Duprin 98/99 exit devices Grade 1

Von Duprin created the first exit device in 1908, and continues to redefine the industry today with unsurpassed quality and industry-unique features such as concealed vertical cables. The 98/99 Series exit device is intended for standard-stile doors. For use with 996L trim only.



Von Duprin 33A/35A exit devices Grade 1

Offering the same innovate features as the 98/99 Series, the 33A/35A Series of exit devices is intended for narrow-stile doors. For use with 360L trim only.



Von Duprin 94/95 exit devices Grade 1

The 94/95 has the pushbar trim recessed into the door to minimize the external profile, allowing more room for people and equipment to pass through. For use with 940L trim only.

Images shown with Schlage L Mortise 'A' rose; additional rose and escutcheon designs available.

The Standard Collection

Built on our tradition of raising industry standards.

Like the M Collection, these lever designs suite with exit devices and locks from our trusted Schlage and Von Duprin brands. And, they are built to the same exacting standards.

Our Standard Collection levers offer a more traditional style that is appropriate for use in a number of commercial applications.

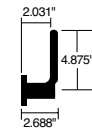
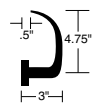
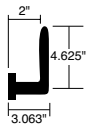

Longitude

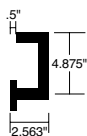

Merano

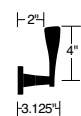

Omega

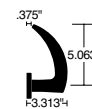

Finish options											
Color	Bright brass	Satin brass	Antique brass	Satin bronze	Oil rubbed Bronze	Satin nickel	Bright chrome	Satin chrome	Bright stainless steel	Satin stainless steel	Aged bronze
ANSI/BHMA number	605	606	609	612	613	619	625	626/626AM	629	630/630AM	643
US number	US3	US4	US5	US10	US10B	US15	US26	US26D	US32	US32D	US11

AM = Antimicrobial.
See pricebook for additional trim and finish availability. 33A, 95 & 99 devices not available in 619 & 630 finishes.

05
♿

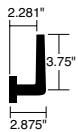

06
♿

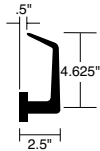

07
♿

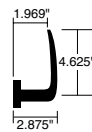

Accent
♿

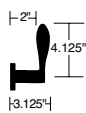

Asti
♿

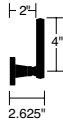

Latitude
♿



St Annes
♿

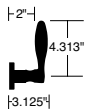

To learn more about suiting of Schlage and Von Duprin products with our decorative or standard levers contact your security consultant or visit allegion.com/us.

Escutcheons and roses

Choose from three types of escutcheon and two rose sizes to add tough, durable performance to your lockset.

Escutcheons



L Full face

Specify by adding 'L' after lever design.

Material: Cold-forged brass, bronze or stainless steel

Finishes: 605, 606, 609, 612, 613, 619, 625, 626, 629, 630, 643e

Size: 8" x 1 3/4" x 7/16"
(203 mm x 44 mm x 11 mm)

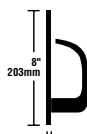

L Concealed

Specify by adding 'C' suffix to function and by adding 'L' after lever design.

Material: Cold-forged brass, bronze or stainless steel

Finishes: 605, 606, 609, 612, 613, 619, 625, 626, 629, 630, 643e

Size: 8" x 1 3/4" x 7/16"
(203 mm x 44 mm x 11 mm)



N Escutcheon

Specify by adding 'N' after lever design.

Material: Heavy wrought reinforced brass, bronze or stainless steel

Finishes: 605, 606, 609, 612, 613, 619, 625, 626, 629, 630, 643e

Size: 8" x 2 9/16" x 7/16"
(203 mm x 65 mm x 11 mm)



Roses



A Wrought rose

2 1/8" (54 mm) diameter
Available for use on L Series knob and lever designs. Specify by adding 'A' after lever design

Finishes: 605, 606, 609, 612, 613, 619, 625, 626, 629, 630, 643e



B Wrought rose

2 9/16" (65 mm) diameter
Available for use on L Series knob and lever designs. Specify by adding 'B' after lever design.

Finishes: 605, 606, 609, 612, 613, 619, 625, 626, 629, 630, 643e



C Wrought rose

2 5/8" (66 mm) diameter
Available for use on L Series knob and lever designs. Specify by adding 'C' after lever design.

Finishes: 605, 606, 609, 619, 625, 626, 629, 630, 643e

Thumbturns

Choose from three variations of thumbturn locks that help you meet the demands of specialized commercial projects.



Hotel occupancy indicator 09-611

For lock function L9486P, this unit can be used with A or B roses. Requires a 1 3/8" (35 mm) cylinder for 1 3/4" (44 mm) doors. Specify finish when ordering separately.



Optional EZ turn L583-363

Available for rose and escutcheon trim. Disability turn (ADA) option to standard thumbturn. Can be used with thumbturn-function L Series lock except L9463 and L463. Specify lock per L583-363 when ordering.



Coin turn

For lock function L9044 and L9444 with rose trim. Specify 09-509 and finish per L283-124 when ordering.

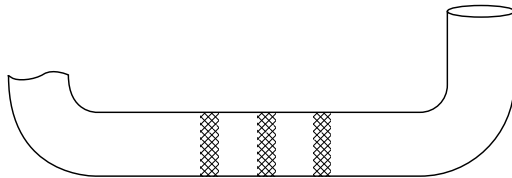

03 Lever shown

Products featuring a knurled surface will be indicated by adding the prefix "8" to the lever number. For example, L9050P 803A/03A.

Tactile warning (knurling)

Schlage L Series commercial levers feature knurling only on the outside lever unless otherwise specified.

This feature is available on the following lever models:

01, 02, 03, 05, 06, 07, 12, 17, 18, 41, 42 and 93.

Lock functions

Lock components

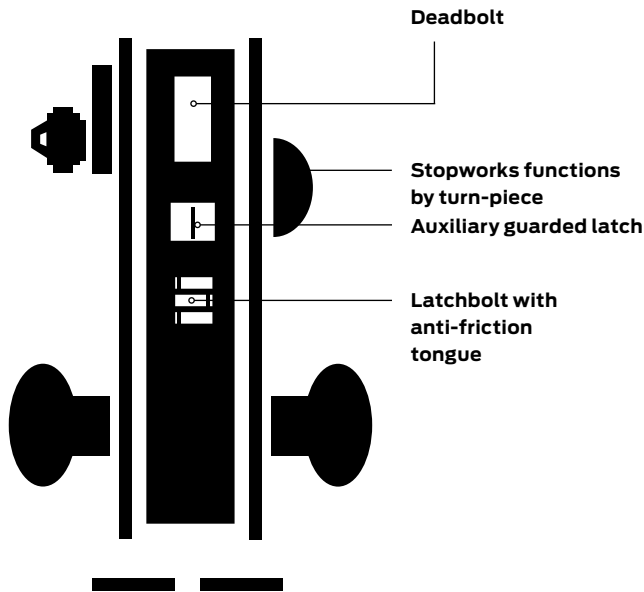

Symbol key

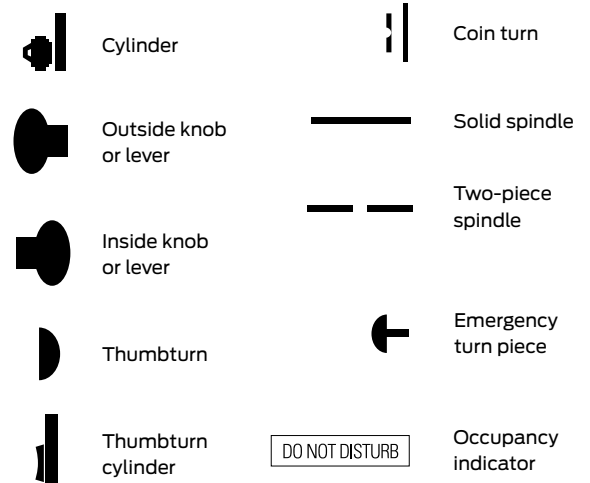

Product identification guide

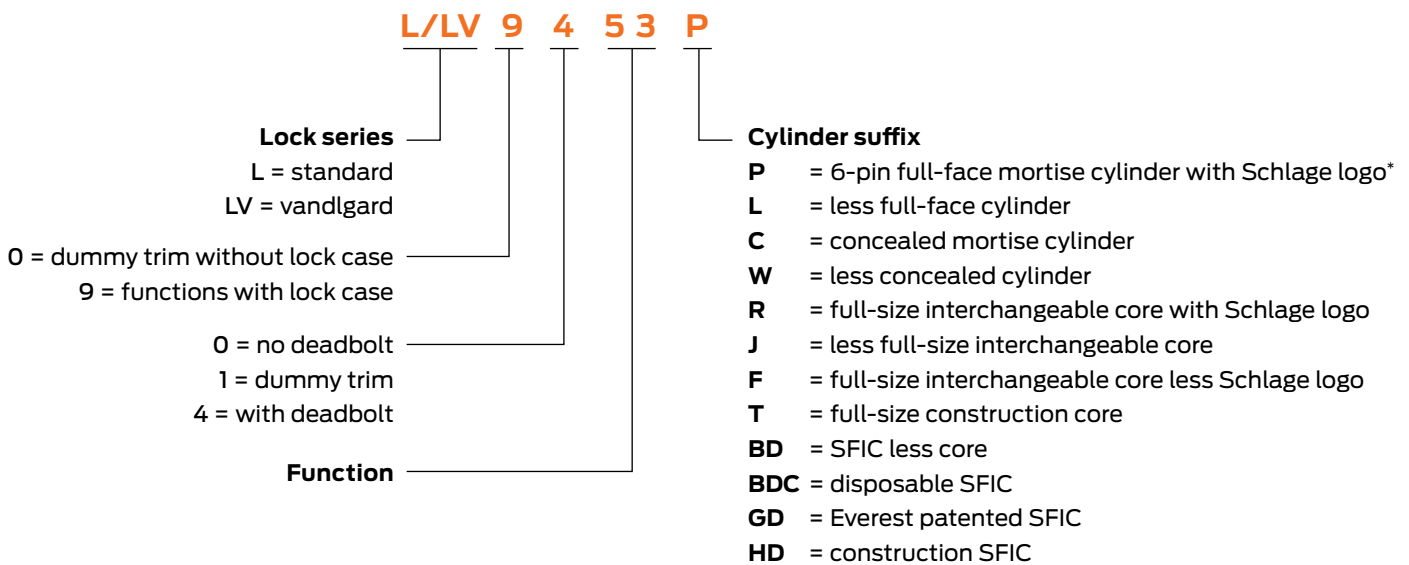

SFIC = Small Format (Best® style) Interchangeable Core
 To order less Schlage logo, specify lock
 "with K510-612 faceplate."

LV = Vandlgard® function allows exterior lever to rotate freely down while remaining securely locked.

Lock functions

ANSI A156.13, Series 1000



Schlage ANSI
L9010 F01

Passage latch

Latchbolt retracted by knob/lever from either side at all times. Inside lever is always free for immediate egress.



L9040 F22
LV9040

Bath/bedroom privacy lock

Latchbolt retracted by knob/lever from either side unless outside is locked by inside thumbturn. Turning inside knob/lever or closing door unlocks outside knob/lever. To unlock from outside remove emergency button, insert emergency thumbturn (furnished) in access hole and rotate. Inside lever is always free for immediate egress.



L9044
LV9044

Privacy with coin turn outside

Latchbolt retracted by knob/lever from either side unless outside is locked by inside thumbturn or outside coin turn. Operating inside knob/lever, closing door, rotating inside thumbturn or rotating outside coin turn unlocks outside knob/lever. Specify per L283-056 for Torx® screws. Available with rose trim only. (Previously XL11-868)



L9440 F19
LV9440

Privacy with deadbolt

Latchbolt retracted by knob/lever from either side. Deadbolt thrown or retracted by inside thumbturn. Throwing deadbolt locks outside knob/lever. Rotating inside knob/lever simultaneously retracts deadbolt and latchbolt, and unlocks outside knob/lever. To unlock from outside remove emergency button, insert emergency thumbturn in access hole and rotate. Inside liner is always free for immediate egress. (Previously XL11-761.)



Schlage ANSI
L9444
LV9444

Privacy with deadbolt and coin turn outside

Latchbolt retracted by knob/lever from either side. Deadbolt thrown or retracted by inside thumbturn or outside coin turn. Throwing deadbolt locks outside knob/lever. Rotating inside knob/lever simultaneously retracts deadbolt and latchbolt, and unlocks outside knob/lever. Rotating outside coin turn retracts deadbolt and unlocks outside knob/lever. Specify per L283-056 for Torx screws. Available with rose trim only. Inside lever is always free for immediate egress. (Previously XL11-868)



L0170
Half dummy trim

Knob/lever on one side fixed by mounting bar.

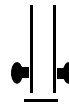

L0172
Full dummy trim

Knob/lever on both sides fixed by mounting bar.



L9175
Half dummy trim with lock case

Fixed knob/lever on one side inoperable. Includes lock case and armored front. Options same as L9176 below.



L9176
Full dummy trim with lock case*

Fixed knob/lever on both sides. Includes lock case and blank armor front. May be ordered with optional XL11-743 armored front with cutout to receive deadbolt.

*In a double-door application where the dummy will be used as the strike order 10-091 Armored Front Strike separately.

Lock functions

Single cylinder non-deadbolt functions



Schlage ANSI
L9050 **F04**
LV9050

Office and inner entry lock

Latchbolt retracted by knob/lever from either side unless outside is made inoperative by key outside or by turning inside thumbturn. When outside is locked, latchbolt is retracted by key outside or by knob/lever inside. Outside knob/lever remains locked until thumbturn is returned to vertical or unlocked by key. Auxiliary latch deadlocks latchbolt when door is closed. Inside liner is always free for immediate egress.



L9056
LV9056

L9050 with automatic unlocking

Latchbolt retracted by knob/lever from either side unless outside is made inoperative by key outside or by rotating inside thumbturn. Outside knob/lever unlocked by key outside, thumbturn or closing door. Rotating inside knob/lever simultaneously retracts latchbolt and unlocks outside knob/lever. Auxiliary latch deadlocks latchbolt when door is closed. Inside lever is always free for immediate egress.



L9070 **F05**
LV9070

Classroom lock

Latchbolt retracted by knob/lever from either side unless outside is locked by key. Unlocked from outside by key. Inside knob/lever always free for immediate exit. Auxiliary latch deadlocks latchbolt when door is closed. Inside lever is always free for immediate egress.



L9076 **F06**
LV9076

Classroom holdback lock

Latchbolt retracted by knob/lever from either side unless outside is locked by key. When locked, latchbolt retracted by key outside or knob/lever inside. Auxiliary latch deadlocks latchbolt when door is closed. Depress inside knob/lever and turn key 360° for holdback feature. Inside lever is always free for immediate egress.



L9080 **F07**
LV9080

Storeroom lock

Latchbolt retracted by key outside or by knob/lever inside. Outside knob/lever is always inoperative. Auxiliary latch deadlocks latchbolt when door is closed. Inside lever is always free for immediate egress.



Schlage ANSI
L9080EL
LV9080EL

Electrically locked (fail safe)

Outside knob/lever continuously locked by 24V AC or DC. Latchbolt retracted by key outside or by knob/lever inside. Switch or power failure allows outside knob/lever to retract latchbolt. Auxiliary latch deadlocks latchbolt when door is closed. Inside knob/lever always free for immediate exit. Inside lever is always free for immediate egress.



L9080EU
LV9080EU

Electrically unlocked (fail secure)

Outside knob/lever unlocked by 24V AC or DC. Latchbolt retracted by key outside or knob/lever inside. Auxiliary latch deadlocks latchbolt when door is closed. Inside lever is always free for immediate egress.



L9080EL-RX / LV9080EL-RX
L9080EU-RX / LV9080EU-RX

Request to exit (RX) electrified lock

Same as L9080EL and L9080EU functions. In addition, a micro-switch positioned inside the lock case monitors the retractor crank, and is actuated when rotation of the inside or outside knob/levers rotates the retractor hub. The switch signals the use of that opening to security systems, allowing a non-disruptive means of immediate egress. Specify per L283-263 with L functions, specify L283-239 with LV functions. Inside lever is always free for immediate egress.

Lock functions

Single cylinder deadbolt functions



Schlage ANSI
L9453 F20
LV9453
Entrance lock

Latchbolt retracted by knob/lever from either side unless outside is locked by 20° rotation of thumbturn. Deadbolt thrown or retracted by 90° rotation of thumbturn. When locked, key outside or knob/lever inside retracts deadbolt and latchbolt simultaneously. Outside knob/lever remains locked until thumbturn is restored to vertical position. Throwing deadbolt automatically locks outside knob/lever. Auxiliary latch deadlocks latchbolt when door is closed. Inside lever is always free for immediate egress.



L9456 F13
LV9456
Corridor lock

Latchbolt retracted by knob/lever from either side. Deadbolt thrown or retracted by key outside or inside thumbturn. Throwing deadbolt locks outside knob/lever. Turning inside knob/lever simultaneously retracts deadbolt and latchbolt and unlocks outside knob/lever. Inside lever is always free for immediate egress.



L9465
Closet/storeroom lock

Latchbolt retracted by knob/lever from either side. Deadbolt thrown or retracted by key outside.



L9473 F21
Dormitory/bedroom lock

Latchbolt retracted by knob/lever from either side. Deadbolt thrown or retracted by key outside or thumbturn inside.



L9480 F21
LV9480
Storeroom lock with deadbolt

Latchbolt retracted by key outside or by lever or knob inside. Outside knob/lever always fixed. Deadbolt thrown or retracted by key outside or thumbturn inside. Turning inside knob/lever simultaneously retracts both deadbolt and latchbolt. Auxiliary latch deadlocks latchbolt when door is closed. Inside lever is always free for immediate egress. (Previously XL11-591)



L9485 x XL11-557
Prison function lock

Latch retracted by key outside or knob inside. Outside knob always free spinning. Deadbolt only thrown or retracted by guard's key. Inside knob becomes fixed when deadbolt is thrown. Prisoner's key only retracts latchbolt. Furnished standard with tamper-resistant Torx screws. Specify per XL11-557.



Schlage ANSI
L9485 F20
LV9485
Faculty/hotel/restroom lock

Latchbolt retracted by key outside or by knob/lever inside. Outside knob/lever always fixed. Deadbolt thrown or retracted by inside thumbturn. When deadbolt is thrown all keys become inoperative except emergency or display keys. Turning inside knob/lever retracts both deadbolt and latchbolt simultaneously. Auxiliary latch deadlocks latchbolt when door is closed. Inside lever is always free for immediate egress.



L9486 F15
LV9486
Faculty/hotel/restroom lock
“do not disturb” indicator

Latchbolt retracted by key outside or by knob/lever inside. Outside knob/lever always fixed. Deadbolt thrown or retracted by inside thumbturn. When deadbolt is thrown “do not disturb” plate is displayed. All keys become inoperative except emergency or display keys. Turning inside knob/lever retracts both deadbolt and latchbolt simultaneously. Auxiliary latch deadlocks latchbolt when door is closed. Inside lever is always free for immediate egress.



L9486 x L583-375
LV9486 x L583-375
L9486 with “occupied” indicator

Latchbolt retracted by key outside or by knob/lever inside. Outside knob/lever always fixed. Deadbolt thrown or retracted by inside thumbturn. When deadbolt is thrown “Occupied” plate is displayed and all keys become inoperative except emergency keys. Turning inside knob/lever simultaneously retracts both deadbolt and latchbolt. Auxiliary latch deadlocks latchbolt when door is closed. Inside lever is always free for immediate egress. (Previously XL11-580)



L9496
Privacy with “occupied” indicator

Knob/lever retracts latchbolt from either side. Deadbolt thrown or retracted by key outside (retraction by key required in the event of an emergency) or inside thumbturn. Throwing deadbolt locks outside knob/lever and displays “Occupied” plate. Rotating inside knob/lever simultaneously retracts both deadbolt and latchbolt, and unlocks outside knob/lever. Inside lever is always free for immediate egress. (Previously XL11-885)

* In a double-door application where the dummy will be used as the strike order 10-091 Armored front strike separately.

Lock functions

Double cylinder non-deadbolt functions



Schlage ANSI
L9060 F09
LV9060

Apartment entrance lock

Latchbolt retracted by knob/lever from either side unless outside is locked by key from inside. When locked, latchbolt retracted by key outside or knob/lever inside. Auxiliary latch deadlocks latchbolt when door is closed. Inside lever is always free for immediate egress.



L9071
LV9071

Classroom security lock

Latchbolt retracted by knob/lever from either side unless outside is locked by key from either side. When locked, latchbolt retracted by key outside or knob/lever inside. Auxiliary latch deadlocks latchbolt when door is locked. Inside lever is always free for immediate egress.



L9077
LV9077

Classroom security holdback lock

Latchbolt retracted by knob/lever from either side unless outside is locked by key from either side. When locked, latchbolt retracted by key outside or knob/lever inside. Auxiliary latch deadlocks latchbolt when door is locked. Depress inside knob/lever and turn key 360° for holdback feature. Inside lever is always free for immediate egress.



L9082 F30
LV9082

Institution lock

Latchbolt retracted by key from either side. Knob/lever on both sides always inoperative. Auxiliary latch deadlocks latchbolt when door is closed.



L9082EL
LV9082EU

L9082 electrically locked or electrically unlocked both sides*

EL: Outside and inside knob or lever continually locked electrically. Latchbolt retracted by key either side. Switch or power failure allows outside and inside knob/lever to retract latchbolt. Auxiliary latch deadlocks latchbolt when door is closed. EU: Outside and inside knob/lever unlocked electrically. Latchbolt retracted by key either side. Switch or power failure keeps inside and outside knob/lever locked. Auxiliary latch deadlocks latchbolt when door is closed. (Previously XL11-452)

Lock functions

Double cylinder deadbolt functions



Schlage ANSI
L9457
LV9457

Classroom security lock with deadbolt

Latchbolt retracted by knob/lever from either side. Deadbolt thrown or retracted by key from either side. Throwing deadbolt locks outside knob/lever. Turning inside knob/lever simultaneously retracts deadbolt and latchbolt, and unlocks outside knob/lever. Inside lever is always free for immediate egress.



L9466 **F14**

Store/utility room lock with deadbolt*

Latchbolt retracted by knob/lever from either side. Deadbolt thrown or retracted by key from either side.



L9482 x XL11-943
LV9482 x XL11-943

Institution lock with deadbolt*

Latchbolt retracted by key from either side. Knob/lever on both sides always inoperative. Deadbolt thrown or retracted by key either side. Auxiliary latch deadlocks latchbolt when door is closed. Specify per XL11-543.

In a double-door application where the dummy will be used as the strike order 10-091 Armored front strike separately.

*Caution: Double cylinder locks on residences and any door in any structure which is used for egress are a life safety hazard in times of emergency and their use is not recommended. Installation should be in accordance with existing codes only.

Lock functions

Full mortise deadlocks



Schlage ANSI
L9460 **F17**

Cylinder x thumbturn lock

Deadbolt thrown or retracted by key outside or thumbturn inside.



L9462 **F16**
Double cylinder lock*

Deadbolt operated by key from either side.



L9463
Classroom lock

Deadbolt thrown or retracted by key from outside. Inside thumbturn cylinder retracts deadbolt, but cannot project it.



L9464 **F18**
Cylinder lock

Deadbolt thrown or retracted by key from one side. No trim on opposite side.



L9460 x XL11-635
L9460 with pull

Knob/lever both sides fixed. Deadbolt thrown or retracted by key outside or thumbturn inside.



L9460 x XL11-886
Single cylinder deadlock with pull

Deadbolt thrown or retracted by key outside or thumbturn inside. No latch, but inside knob or lever is spring-loaded. Rotating inside knob/lever also retracts deadbolt. Fixed outside knob/lever.



L9462 x XL11-886
Double cylinder deadlock with pull*

Deadbolt thrown or retracted by key from either side. No latch, but inside knob/lever is spring-loaded. Rotating inside knob/lever also retracts deadbolt. Fixed outside knob/lever.



L9464 x XL11-886
Deadlock with pull

Deadbolt thrown or retracted by key from one side. No latch, but inside knob/lever is spring-loaded. Rotating inside knob/lever also retracts deadbolt. Fixed outside knob/lever.

Lock functions

Small mortise deadlocks



Schlage ANSI
L460 **E06071**

Cylinder x thumbturn lock

Deadbolt thrown or retracted by key outside or thumbturn inside.



L462 **E06061**
Double cylinder lock*

Deadbolt operated by key from either side.



L463 **E06091**
Classroom lock

Deadbolt thrown or retracted by key from outside. Inside thumbturn cylinder retracts deadbolt, but cannot project it.



L464 **E06081**
Cylinder lock

Deadbolt thrown or retracted by key from one side. No trim on opposite side.



L480
Door bolt

Deadbolt thrown or retracted by thumbturn from one side. No trim on opposite site.













L496
Deadbolt with "occupied" indicator

Deadbolt thrown or retracted by key outside or thumbturn inside. When deadbolt is thrown "Occupied" plate is displayed. (Previously XL11-911)























Schlage L Series universal transformation instructions

The L9050 universal case can be transformed into nine different functions* with just a few additional parts.

For some functions, additional parts are not necessary.

ANSI function	Function type	Function description
F04	 L9050 (w/thumbturn) office	Latchbolt operated by lever either side except when outside lever is made inoperative by a stop or other mechanical means other than key. When outside lever is locked, latchbolt is retracted by key from outside or by operating inside lever. Auxiliary deadlatch.
F01	 L9010 passage	Latchbolt operated by lever from either side at all times.
F05	 L9070 classroom	Latchbolt operated by lever either side except when outside lever is locked from outside by key or push button mechanism. When outside is locked latchbolt is retracted by key or by operating key or push button, and outside lever from outside or by operating inside lever. Auxiliary deadlatch.
F07	 L9080 storeroom	Latchbolt operated by key outside or by operating inside lever. Outside lever always inoperative. Auxiliary deadlatch.
F09	 L9060 apartment entrance	Latchbolt operated by lever either side, except when made inoperative by key from inside. When outside is locked latchbolt is retracted by key from outside or by operating inside lever. Auxiliary deadlatch.
F31	 L9080 (less outside cylinder) exit or communicating	Latchbolt operated by inside lever. Non-removable blank trim or no trim outside.
F32	 L9071 classroom security	Latchbolt retracted by lever either side except when outside lever is locked by key from inside or outside. When outside lever is locked latchbolt is retracted by key either side or by inside lever. Auxiliary deadlatch.
	 L9080 (less outside lever) service	Latchbolt operated by key outside or by operating inside lever. No outside lever. Auxiliary deadlatch.
	 L9080 (less inside trim) utility	Latchbolt retracted by key outside; outside lever always inoperative. No inside trim. Auxiliary deadlatch.
	 L9070 (less inside trim) closet	Latchbolt operated by lever on outside except when outside lever is locked from outside by key. When outside is locked latchbolt is retracted by key or by operating key from outside lever. Auxiliary deadlatch.

* Assumes Everest cylinders and L9050 as base function (L283-133 chassis/L9050LB distributor lock case) — only applies to sectional trim (not escutcheon).

Transformation instructions	Additional part(s)				
Install cloverleaf cam cylinder on outside; install thumbturn assembly 09-509-027 on inside.	No additional parts required.				
Do not install thumbturn unit 09-509-027 on inside or cylinder outside. Install chassis in the unlocked position.	No additional parts required.				
Install cloverleaf cam cylinder on outside; do not install thumbturn assembly 09-509-027 on inside.	No additional parts required.				
Do not install thumbturn 09-509-027 on inside. Install chassis in the locked position. Replace cloverleaf cam L583-153 with straight cam B502-948 (Everest), L583-255 with K510-680 (IC and SFIC) and install on outside.	Cams B502-948 (Everest), K510-680 (IC and SFIC) or L583-476 or L583-477 for modular cylinders	 B502-948	 K510-680	 L583-476 1 1/8" / 1 3/8" / 1 5/8"	 L583-477 1 1/4" / 1 1/2" / 1 3/4"
Do not install thumbturn 09-509-027 on inside. Install cloverleaf cam cylinder on inside. Replace clover leaf cam L583-153 with straight cam B502-948 (Everest), L583-255 with K510-680 (IC and SFIC) and install on outside.	Mortise cylinder assembly and cams B502-948 (Everest), K510-680 (IC and SFIC) or L583-476 for modular cylinders	 B502-948	 K510-680	 L583-476 1 1/8" / 1 3/8" / 1 5/8"	 L583-477 1 1/4" / 1 1/2" / 1 3/4"
Do not install thumbturn unit 09-509-027 on inside. Install chassis in the locked position. Install inside lever with L285-150 mounting plate; do not install outside lever or cylinder.	Mounting plate L283-150	 L283-150			
Do not install thumbturn unit 09-509-027 on inside. Install cloverleaf cam cylinder on inside and outside.	Mortise cylinder assembly and cam L583-153	 Mortise cylinder assembly	 L583-153	 L583-274 1 1/8" / 1 3/8" / 1 5/8"	 L583-275 1 1/4" / 1 1/2" / 1 3/4"
Do not install thumbturn unit 09-509-027 on inside. Install chassis in the locked position. Replace cloverleaf cam L583-153 with straight cam B502-948 (Everest), L583-255 with K510-680 (IC and SFIC) and install on outside. Install inside lever with L285-150 mounting plate; do not install outside lever.	Cams B502-948 (Everest), K510-680 (IC and SFIC), mounting plate L283-150 or L583-476 or L583-477 for modular cylinders	 L283-150	 B502-948	 K510-680	 L583-476 1 1/8" / 1 3/8" / 1 5/8"
Do not install thumbturn unit 09-509-027 on inside. Install chassis in the locked position. Replace cloverleaf cam L583-153 with straight cam B502-948 (Everest), L583-255 with K510-680 (IC and SFIC) and install on outside. Install inside lever on outside with L283-150 mounting plate; do not install inside lever.	Cams B502-948 (Everest), K510-680 (IC and SFIC), mounting plate L283-150 or L583-476 or L583-477 for modular cylinders	 L283-150	 B502-948	 K510-680	 L583-476 1 1/8" / 1 3/8" / 1 5/8"
Install cloverleaf cam cylinder on outside; do not install thumbturn assembly 09-509-027 on inside. Install inside trim on outside with L283-150 mounting plate.	Mounting plate L283-150	 L283-150			

Electrified lock function



L9080PEL
L9080PEU
L9082PEL
L9082PEU

Applications:

Security control centers, cashier rooms, fire safety exits, stairwell doors, telephone equipment rooms, computer rooms, hospital equipment and narcotics storage areas.

Regulating devices:

Recognition Systems, Inc., Hand Readers, wall switches, security consoles, access card readers, thermo-sensitive devices, smoke and fire alarms, telephone access controls, automatic time devices and computerized controls.

All installations should be in accordance with local electrical codes and National Electrical Code, NFPA 70.

Electrical Requirements for EL or EU

Voltage: 24V AC or 24V DC (maximum 26V, minimum 22V)

Peak current: Amps 1.3 at 5- to 10-second intervals

Holding current: Amps .135 between peak current intervals

Operating temperature: Maximum +151° F, minimum -31° F

Micro switch electrical requirements for Request to Exit (RX) function

Amps: 1.0

Volts: 24 AC or DC

Peak load: Amps, 5; volts, 250 AC or DC

Replacement kit

L283-053 – Solenoid and driver, EL or EU

Typical wiring diagram for electrified L Series locks

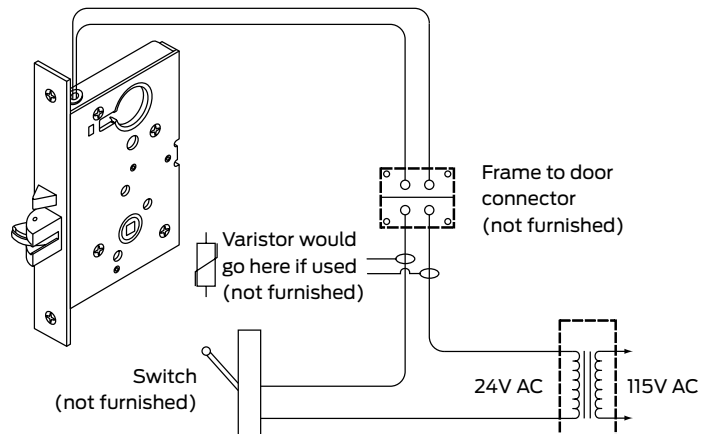

Typical installation

- Electrified L Series locks contain a transistorized circuit that provides full voltage to the solenoid upon initial application of electrical power and at 5- to 10-second intervals.
- Each lock should preferably have its own 24-volt transformer. Two or more locks may be operated in parallel from a single transformer, provided it has the necessary current rating.

Note: DO NOT connect locks in series from a higher voltage rated transformer.

- We DO NOT recommend that these locks be connected to a supply circuit that also contains electromagnetic devices. If an electromagnetic device is connected to the supply circuit, the resulting transient voltages could damage the lock. The transient voltage must be carefully suppressed at the equipment producing them before connecting the lock to the same circuit.
- A varistor rated at 35 volts (peak recurrent) may be used for transient voltage protection.

Cylinder types

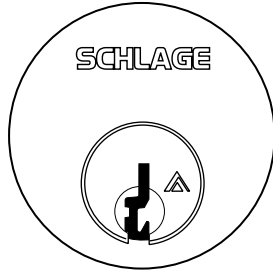

Standard cylinders

Schlage locks are provided with cylinders precision-built to extremely close tolerances and the highest standards of accuracy. Using only solid brass bar stock plugs and shells, phosphor bronze springs, and nickel silver keys and bottom pins ensures long life and ease of operation. Our 6-pin Everest cylinders in C123 keyway with two patented keys are standard for stock. C145 is standard for new master key systems.

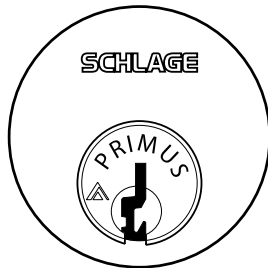

Primus® high security cylinders

Primus high-security cylinders are available to add patented key control and varying degrees of geographical exclusivity to most Schlage 6-pin key systems, whether Everest or Classic keyways. In addition to a conventional pin tumbler mechanism, Primus cylinders incorporate a patented finger pin and sidebar design, providing a “dual-locking” cylinder that is virtually pick-proof. Resistance to drilling and other physical attack is optional by specifying 20-500 Series UL437 Listed cylinders.

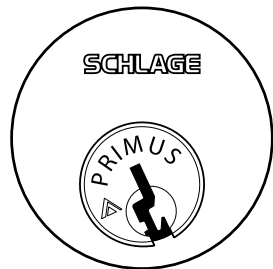

Primus lockout cylinders

For doors where it is frequently desirable to disable all keys from operating the lock temporarily use lockout cylinders. The special lockout key can be removed while the plug is turned to the 11 o'clock position, preventing all normal operating keys, including master keys, from fully entering the cylinder.

Suggested applications for lockout cylinders include laboratories, dark rooms, clean rooms and exterior doors to dormitories.

Schlage will not master key lockout cylinders.

Standard (non-IC) cylinders

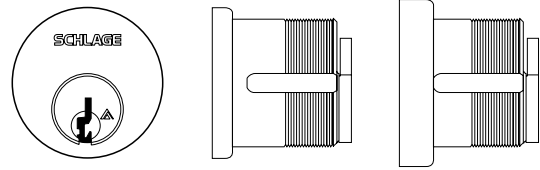

Standard (non-IC) mortise cylinders

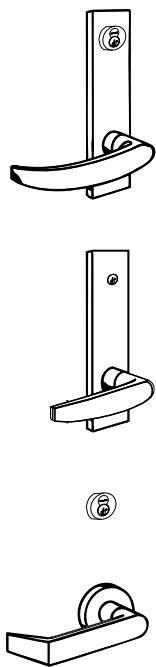

Design	Function	Cylinder mechanism				
		Conventional	Primus	Primus UL437	Primus lockout	Primus UL437 lockout
L & N escutcheons (cylinders and spring only)	All except below	30-021	20-793	20-593	20-717**	20-517**
	L9060P outside	26-021	20-701	20-501	20-501	20-515**
	L9485, L9486 hotel functions	30-022*	N/A	N/A	N/A	N/A
L escutcheon with concealed shell cylinder (C suffix)	all except below	30-004	20-789	20-589	N/A	N/A
	L9080P outside	26-023	N/A	N/A	N/A	N/A
	L9485, L9486 hotel functions	30-005*	N/A	N/A	N/A	N/A
Sectional trim and L400 Series (cylinder with compression ring & spring)	all except below	30-001	20-787	20-587	20-717	20-517
	L9060P outside	20-001	20-700	20-500	20-715	20-515
	L9060P outside	30-002*	N/A	N/A	N/A	N/A

* Specify door hand for hotel function cylinders.

** Discard compression ring for Lockout cylinders with escutcheon trim.

Finishes: 605, 606, 611, 612, 613, 619, 625, 626, 629 and 630.

Concealed shell cylinders available in 606 and 626 only.

6-pin Everest C123 keyway standard for stock cylinders; C145 standard for new key systems.

Standard cylinder lengths: sectionals (rose) trim = 1/8" (29 mm), escutcheon trim = 1/4" (32 mm).

Optional cylinder lengths are in 1/8" (4 mm) increments ranging from 1/8" to 3/4" (29 mm to 44 mm).

Full-size interchangeable core (FSIC) cylinders

Schlage figure-8 interchangeable core (IC) cylinders allow immediate rekeying at the door. Simply use the special control key to replace the core in seconds. Full-size IC cylinders can be integrated into any existing 5- or 6-pin Schlage key system with no adverse effects on keying capacity. Convert existing mortise locks to interchangeable core merely by replacing the old cylinder with the IC cylinder and proper collar(s).

For ordering information see page 35.

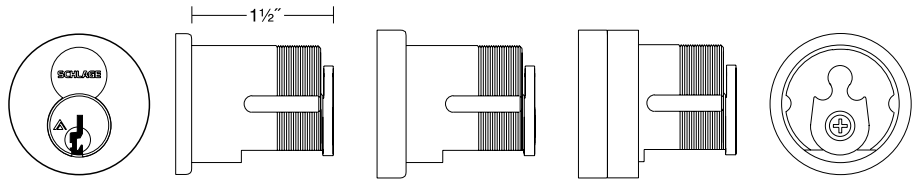

Full-size IC mortise cylinders

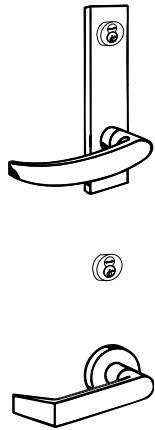

Design	Function	Core mechanism		
		Conventional	Primus	Primus UL437
L & N Escutcheons (cylinders with compression ring)	All except below	30-008	20-798	30-007
	L9060P outside	30-030	20-782	30-032 + 36-083
	L9485P, L9486P hotel functions	30-010*	N/A	30-007
Sectional Trim and L400 Series (cylinder with compression ring, spring and 3/8" blocking ring)	All except below	30-138	20-776	30-137
	L9060P outside	20-061	20-783	30-032 + 36-083 + 35-082-037
	L9485P, L9486P hotel functions	30-140*	N/A	N/A

* Hotel function cores are handed. Specify hand of door. Finishes: 605, 606, 611, 612, 613, 619, 625, and 626. Standard cylinder length is 1 1/2".

Full size interchangeable cores only

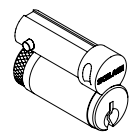

Number	Description
23-030	Conventional core
20-740	Primus high-security core
30-120	Hotel function core (specify hand of door)

Available 606 and 626 finish only.

Standard keyway: 6-pin Everest C123 for stock, C145 for new master key systems

Small format interchangeable core (SFIC) cylinders

The L Series lockset can be ordered to accept small format interchangeable cores (SFIC) compatible with manufacturers such as Falcon, Arrow and Best; cams are easily changeable.

To order Schlage L Series mortise locks with SFIC cylinders less core, change suffix P to BD. Example: L9453BD.

To order locks with Everest B Family restricted keyway cores, change suffix to GD. To order with keyed construction cores, change suffix to HD. To order with disposable construction cores, change suffix to BDC.

For ordering information see page 35.

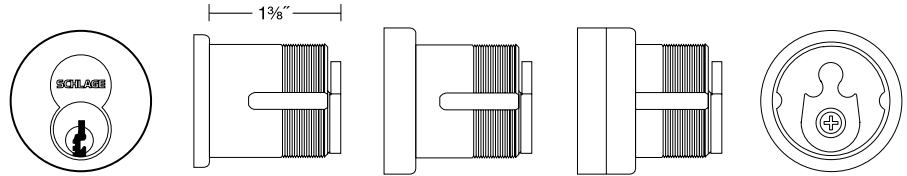

Standard (Non-IC) mortise cylinders



Design	Function	Core mechanism			
		Everest restricted (GD suffix)	Keyed construction (HD suffix)	Disposable construction (BDC suffix)	Housing less core (BD suffix)
L & N escutcheons (cylinders with compression ring and spring)	All* except L9060 outside	80-308	80-138	80-115	80-108
	L9060 outside	30-030	20-782	30-032 + 36-083	80-104
Sectional trim and L400 Series (cylinder with compression ring, spring and 1/4" blocking ring)	All* except L9060 outside	30-138	20-776	30-137	80-101
	L9060 outside	80-304 + 36-082-025	80-134 36-082-025	80-112 36-082-025	80-104 36-082-025

Finishes: 605, 606, 611, 612, 613, 619, 625, and 626.

Standard cylinder length is 1 3/8".

Small format interchangeable core (SFIC) only

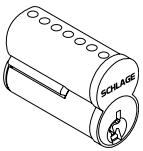

Number	Description
80-036	7-pin uncombined Everest B Family restricted keyways
80-037	7-pin combined Everest B Family restricted keyways
80-043	6-pin uncombined Falcon / Best keyways
80-033	7-pin uncombined Falcon / Best keyways

Available 606 and 626 finish only. Specify keyway for existing systems.

80-033 and 80-043 cores are available in A, D, E, F, G, H, J, K, L, and M keyways.

Schlage assigns the keyway when establishing new Everest restricted key systems.

Blocking and compression rings

36-079



Blocking ring. Specify finish and dimension. Not to be used with 36-083.

36-082



Blocking ring. Specify finish and dimension. Use with 36-083.

36-083

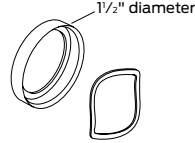

Compression ring and spring. Specify finish and dimension.

L538-195



Compression spring.

Dimensions for blocking rings

Blocking ring length	Dimension
1/8"	012
3/16"	018
1/4"	025
5/16"	031
3/8"	037
7/16"	043
1/2"	050

Full-size interchangeable (FSIC) core blocking ring requirements

Function	Trim	Door thickness			
		1 3/8"	1 3/4"	2"	2 1/4"
		Dimension			
L9050, L9070, L9080, L9410 (disc), L9453, L9456, L9460 per XL11-886 or XL11-635, L9464 per XL11-886, L9465, L9473, L9480, L9496	Rose	050	037	025	025
	Escutcheon	025	012	N/R	N/R
L9485	Rose	—	037	025	025
	Escutcheon	—	012	N/R	N/R
L9486	Rose	012	N/R	N/R	N/R
	Escutcheon	025	012	N/R	N/R
L9060, L9071, L9077, L9082, L9457, L9462 per XL11-886, L9466, L9482	Rose	—	050	043	031
	Escutcheon	025	012	N/R	N/R
L460, L464, L496, L9460, L9464	Rose trim	050	037	025	025
L462, L463, L9462, L9463	Rose trim	—	050	043	031

Small format interchangeable core (SFIC) blocking ring requirements

Function	Trim	Door Thickness			
		1 3/8"	1 3/4"	2"	2 1/4"
		Dimension			
L9050, L9060, L9070, L9071, L9077, L9080, L9082, L9453, L9456, L9457, L9462 per XL11-886, L9465, L9466, L9473, L9482	Rose	037	025	012	N/R
	Escutcheon	N/R	N/R	N/R	N/R
L9050, L9060, L9070, L9080, L9082, L9410 (disc), L9453, L9456, L9460 per XL11-886 or XL11-635, L9464 per XL11-886, L9465, L9466, L9473, L9480, L9496	Rose	—	050	037	025
	Escutcheon	018	N/R	N/R	N/R
L460, L464, L496, L9460, L9464 L462, L463, L9462, L9463	Rose trim	037	025	012	N/R
	Rose trim	—	050	037	025

Classroom thumbturn cylinders

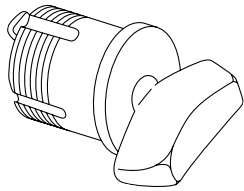

These cylinders are for L463 and L9463 classroom function deadlocks. They are handed. They have a rotational stop in one direction to prevent locking from the inside, but allow unlocking. Cylinders are field-reversible by changing the position of the rotational stop. All cylinders furnished with L583-254 cam.

Number	Collar(s)
09-900	None
09-904	Compression ring and spring
09-905	For 1 ³ / ₄ " doors: compression ring, spring and 1/ ₈ " blocking ring
09-907	For 1 ³ / ₄ " doors: compression ring, spring and 1/ ₈ " blocking ring

Specify hand of door and finish. 1¹/₈" length standard. 09-900 and 09-905 also available in 1/₈" increments up to 1³/₄".

Mortise cylinder cams

Most functions

L400 and L9000 Series



L583-153 Everest and Primus

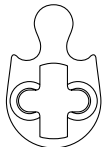

L583-254 classic conventional



L583-255 all IC

L9060 outside only



B502-948 Everest and Primus



B502-191 classic conventional

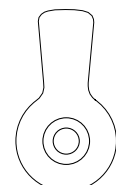

K510-680 all IC

Cams screws

B502-942	Everest and Primus (non-IC)
B502-468	Classic Conventional (non-IC)
L583-333	All full-size interchangeable core
B520-484	All small format interchangeable core

IC installation tool

This tool is used to install and remove mortise cylinder housings and test mortise cylinder cam action for both small format and full-size interchangeable core cylinders. Its other ends are designed to install the driver and retainer for full-size IC in Schlage key-in-knob/lever locksets.

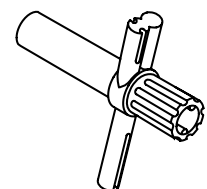

M504-413
(Order as needed)

Armored fronts

L Series armored fronts are produced from brass, bronze or stainless steel material, finished to match lock trim and furnished complete with screws. Numbers for ordering separately or with locks are listed below. Armored fronts are specified in latch column of order form.

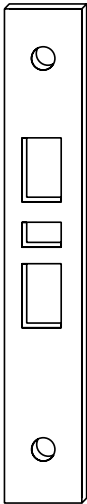

Standard square corner
1/4" (32 mm) width

Square corner		Description
1/4" (32mm) width	1/16" (27mm) Width	
09-662	09-668	Latch: L9010, 9040, 9044
09-663	09-669	Deadlatch: L9050, 9056, 9060, 9070, 9071, 9080, 908
09-664	09-670	Latch x deadbolt: L9444, 9456, 9457, 9465, 9466, 9473, 9496
09-665	09-671	Deadbolt: L9460, 9462, 9463, 946
09-666	09-662	Deadlatch x deadbolt: L9453, 9480, 9485, 948
09-661	09-667	Blank (no holes): L9175, L917
09-713	----	Deadlatch, non-UL: L9076, 9077 (holdback functions)
09-717	----	Deadbolt: L400-Series

Note: For 1 3/8" (35mm) doors, 1/16" (27mm) front should be specified.

Strikes

All L Series strikes are produced from brass, bronze or stainless steel material, finished to match lock trim, and furnished complete with screws. Numbers for ordering separately or with locks are listed below.

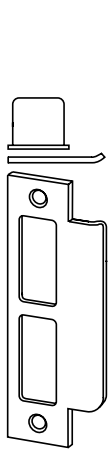

Standard for L9000
10-072
1/4" x 4 7/8" x 1 3/16" lip
32 mm x 124 mm x 30 mm

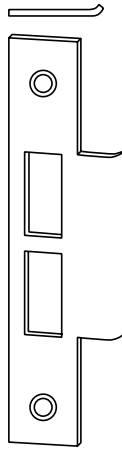

Armored front strike
10-091
1 3/4" x 8" x 1 3/16" lip
32 mm x 203 mm x 30 mm

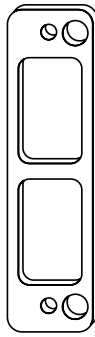

Wood frame reinforcer
37-015

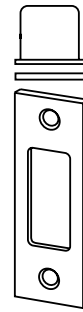

Standard for L400
10-079
1/8" x 3 1/2"
32 mm x 89 mm



Optional for L400
10-078
1/4" x 4 7/8"
32 mm x 124 mm

Number	Lip Length	Description
10-072	1 3/16" (30mm)	L9000 standard
	7/8" (22mm), 1" (25mm), 1 1/2" (38mm)	L9000 optional
	1 3/4" (44mm), 2" (51mm)	L9000 special lip
10-073	No lip	L9460 Series deadlocks
10-075	No lip	1/2" (13mm) rabbeted (use with 1/16" (27mm) armor)
10-078	No lip	1/4" x 4 7/8" with box, L400 optional
10-079	No lip	1/8" x 3 1/2" with box, L400 standard
10-091*	1 3/16" (30mm)	Armored front strike, no box
K510-053	---	Strike box for 10-079
K10-066	---	Strike box, all except 10-079

*Specify hand of inactive leaf.

Door handing

One of the revolutionary features of the L Series mortise lock is that handing can be done by the distributor or installer quickly and easily without opening the lock case. This feature allows a Schlage distributor to order L Series locks as stock and customize the handing to each order's specification. This means off-the-shelf delivery to meet today's fast-track construction requirements. These mix-and-match lever-with-knob combinations, along with a quickly reversible lock chassis, provide the ultimate in stocking, ordering and installation flexibility. Orders can be filled from stock, minimizing delivery problems.

Changing lock hand

No more than two simple steps are required to change the hand of any L Series lock. Rotate the latch unit 180° and/or change the catch screw position.

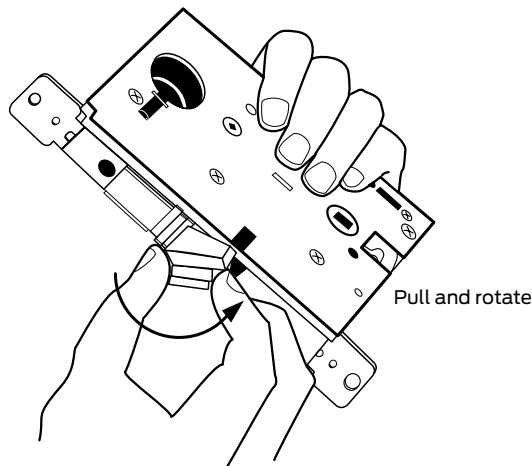

A. Changing latchbolt handing
Remove armored front. Pull latchbolt away from chassis and rotate complete unit 180° to reverse the door handing. Reinstall armored front.

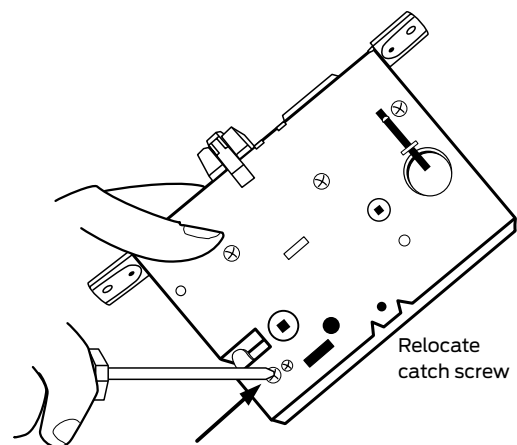

B. Change chassis handing
Remove catch screw from one side of chassis and install on opposite side. For RH and RR, the catch screw will be on the lock case side. For LH and LR, the catch screw will be on the lock case cover.

*Catch screw location reversed for Vandlgard function. For first time users, an instructional video is available.

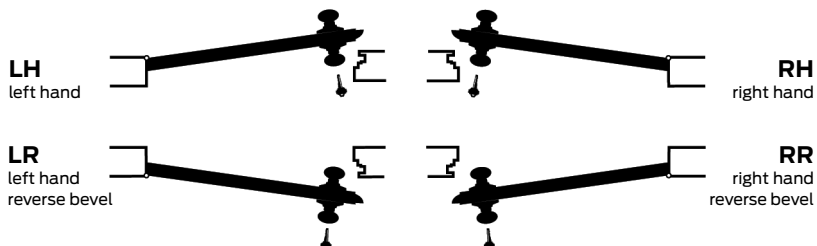

The hand is determined by the direction the door swings when viewed from the exterior or corridor side of the door.

Specifications

Handing:

L9000 Series lock bodies are field-reversible without disassembly. L400 Series locks are non-handed.

Door thickness:

1³/₄" (44 mm) standard. 1³/₈" (35 mm) to 2¹/₂" (64 mm) optional. Over 2¹/₂" (64 mm) door ranges vary by function. No escutcheon available for 1³/₄" (44 mm) doors standard. 2" to 2³/₈" (51 mm to 60 mm) optional. Specify door thickness if other than 1³/₄".

Backset:

2³/₄" (70 mm) only.

Armored front:

L9000 Series: 1¹/₄" x 8" x 7⁷/₃₂" (32 mm x 203 mm x 6 mm) standard. 1¹/₁₆" x 8" x 1⁷/₃₂" (27 mm x 203 mm x 6 mm) optional.
L400 Series: 4⁷/₁₆" x 3⁵/₈" x 1" (113 mm x 92 mm x 25 mm)

Case size:

L9000 Series: 4⁷/₁₆" x 6¹/₁₆" x 1" (113 mm x 154 mm x 25 mm)
L400 Series: 4⁷/₁₆" x 3⁵/₈" x 1" (113 mm x 92 mm x 25 mm)

Spacing:

Knob or lever to cylinder, 3⁷/₈" (98mm); knob or lever to thumbturn hub, 2¹¹/₁₆" (68mm).

Bolts:

1" (25mm) throw stainless steel deadbolt and 3³/₄" (19mm) throw stainless steel latch with anti-friction tongue.

Exposed trim:

Knobs: #41 and #42 heavy-duty wrought brass, bronze or stainless steel knobs match D Series knobs.

Levers: Forged brass or bronze and cast stainless steel. Designs available to match D Series levers.

93 Lever design: Extruded brass, bronze or stainless steel.

Mediterranean designs: Forged-brass lever and rose.

Escutcheons: L escutcheons are cold-forged brass or bronze and stainless steel. N escutcheons are heavy wrought reinforced brass, bronze and stainless steel.

Trim combinations: Available with knob both sides, lever both sides, or knob and lever with rose or escutcheon both sides.

Strike:

L9000 Series: ANSI curved lip strike 1¹/₄" x 4⁷/₈" (32 mm x 124 mm) x 1³/₁₆" (30 mm) lip to center with dust box standard. L400 Series: 1¹/₈" x 3⁵/₈" (29 mm x 92 mm) with dust box.

Cylinder & keys:

6-pin Everest C123 keyway cylinder with two patented keys standard.

Keying options:

Interchangeable core and Primus high security cylinders. Master keying, grand master keying and construction keying.

Certifications

ANSI:

L9000: ANSI A156.13 Series 1000, Grade 1 Operational and Security, UL Listed for 3-hour fire door (except L9076 and L9007). With interchangeable core cylinders: Grade 2 Security.

With concealed shell cylinder: A156.13 Grade 1 Operational and Security. ANSI/ASTM F476-76 Grade 40, UL Listed. L400: ANSI A156.5 Grade 1.

California State Reference Code:

(Formerly Title 19, California State Fire Marshal Standard) All levers with returns comply; levers return to within 1/2" of door face.

UL / cUL:

All locks listed for A label single doors, 4' by 10'. Letter F and UL symbol on latch front indicate listing. Electrified functions are UL19X Listed for single-point locking applications. UL437 Listed locking cylinder optional: specify Primus 20-500 Series cylinder.

Door preparation for L9000 Series

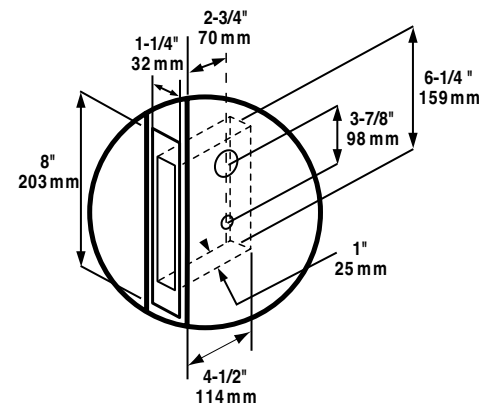

Door preparation for L400 Series

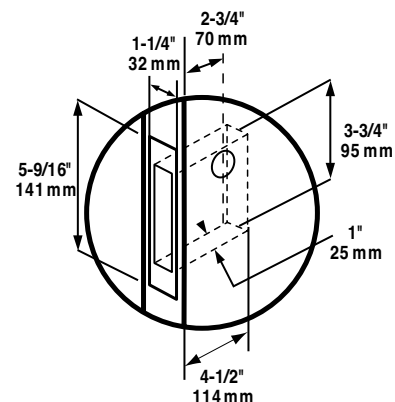











How to order

To order Schlage products, descriptive data should be in the same sequence as shown.

Line item	Qty	Product	Outside		Inside		Hand	Front	Strike	Door thickness	Ext	Dim	Additional details
			Des	Fin	Des	Fin							
1	2	3	4	5	6	7	8	9	10	11	12	13	14

- 1 Line item number
- 2 Quality
- 3 Complete model number with function and cylinder type

To order cylinder options, change “P” at the end of the model number as follows:

	L9453P	Standard
	L9453L	Less standard cylinder. For Primus cylinder, specify this option and order Primus cylinder separately.
	L945C	With temporary plastic construction cylinder. Double cylinder functions ordered less cylinder are furnished with these construction cylinders to maintain timing of key cams.
	L9453J	Prepared for full size interchangeable core, less core. For Primus core, specify this option and order Primus core separately.
	L9453R	With full-size conventional interchangeable core installed. Order control keys separately.
	L9453T	With full-size (temporary) construction core installed. Order all keys separately.
	L9453BD	Prepared for small format (Falcon, Best, etc.) interchangeable core (SFIC), less core.
	L9453GD	With Everest B Family restricted keyway small format core installed. Order control keys separately.
	L9453HD	With small format keyed brass construction core installed. Order all keys separately.
	L9453BDC	With small format disposable plastic construction core installed.

- 4/5 Outside design / finish. Specify tactile warning (knurling) here as “8” before lever design, e.g. 803. To specify complete design, combine the numeric knob or lever design with the alpha rose or escutcheon design. Example: 03L, 93A, 42B. When ordering Mediterranean design levers with L escutcheons, specify AST/00L, AVA/00L or MER/00L.
- 6/7 Inside design/finish. Leave blank if same as outside.
- 8 Hand. One hand per line item.
- 9 Front (use “Strike” field on Schlage form). Leave blank for standard armored front or enter number for narrow front.
- 10 Strike. Leave blank for standard or specify part number for optional strike. LLL = Less strike.
 100 = 1" 114 = 1¼" 112 = 1½" 200 = 2"
 118 = 1⅞" 138 = 1⅝" 134 = 1¾"
- 11 Door thickness, if non-standard. Example: 200 = 2".
- 12 Extension, to specify whether thick door is extended inside (EI), outside (EO), differently (ED) or equally (EE).
- 13 Dimension for strike lip lengths. See strike page for availability of specific dimensions with specific strikes.
- 14 Keying detail (e.g. key symbol, keyway, bitting) and other special requirements.

Example

Line item	Qty	Product	Outside		Inside		Hand	Front	Strike	Door thickness	Ext	Dim	Additional details
			Des	Fin	Des	Fin							
1	50	L9453P	03A	626			RH		10-091				
2	50	L9453P	03A	626			LH		10-091				
3	10	L9040	03A	626			RH			138			
4	10	L9040	03A	626		625	LH	09-668		138			
5	50	L9456P	07L	626		625	RH	09-668					
6	50	L9456P	07L	626			LH						

Note: Schlage order forms are available at no charge by contacting your Allegion security & safety consultant or customer service.

About Allegion

Allegion (NYSE: ALLE) creates peace of mind by pioneering safety and security. As a \$2 billion provider of security solutions for homes and businesses, Allegion employs more than 8,000 people and sells products in more than 120 countries across the world. Allegion comprises 27 global brands, including strategic brands CISA®, Interflex®, LCN®, Schlage® and Von Duprin®.

For more, visit www.allegion.com

aptiQ ■ LCN ■ **SCHLAGE** ■ STEELCRAFT ■ VON DUPRIN